

2014

SIERRA HD

GMC | WE ARE PROFESSIONAL GRADE



MODELS

3 Introduction

6 Interior

FEATURES & BENEFITS

10 Exterior

12 Interior Convenience

14 Entertainment

16 Drivetrain

18 Chassis

20 Trailering

21 Safety

SELECTION

22 Interior Colors

23 Exterior Colors

24 Accessories

25 Specifications





2014 GMC SIERRA HD. Continuous innovation results from a steadfast refusal to engineer anything less than Professional Grade vehicles. That's why the 2014 Sierra Heavy Duty series works hard and smart at the same time. Rejecting compromise and crafting every detail, it is the strongest, most powerful and most capable lineup of Sierra HD pickups, ever. Engineered to help you achieve more, haul more and trailer more thanks to deep reserves of heavy-duty power and torque. And now GMC Pro Grade Protection is standard on every 2014 Sierra HD. Learn more about this enhanced peace of mind on page 15. GMC. We Are Professional Grade.

SIERRA 2500HD CREW CAB SLT IN QUICKSILVER METALLIC
shown with available equipment.

Overpower obstacles with a
choice of powertrains, pg. 16.



Put the high-strength, fully boxed steel HD frame to work, pg. 18.



MODELS

SIERRA 2500HD AND 3500HD: DOING MORE. WITH MORE.

When there's tough work to do or serious recreation to enjoy, GMC Sierra 2500HD and Sierra 3500HD are your trucks. They share intelligence, versatility and strength—both models offer the most standard trailering in their class—distinguished only by their capabilities. Sierra 2500HD provides a maximum $\frac{3}{4}$ -ton fifth-wheel trailer rating of up to 17,800 lbs¹ and a maximum payload of up to 4212 lbs.² Elevate the capability with Sierra 3500HD in either single- or dual-rear-wheel configurations and get a max fifth-wheel trailer rating of up to 23,100 lbs¹ and a max payload of up to 7222 lbs.² In either series, you can raise the standards of Professional Grade to the highest level of excellence with Sierra Denali.

¹Maximum trailer weight ratings are calculated assuming a base vehicle, except for any option(s) necessary to achieve the rating, plus driver. The weight of other optional equipment, passengers and cargo will reduce the maximum trailer weight your vehicle can tow. See your GMC dealer for additional details. ²Maximum payload capacity includes weight of driver, passengers, optional equipment and cargo.

SIERRA 3500HD CREW CAB SLT WITH DUAL REAR WHEELS
IN QUICKSILVER METALLIC shown with available equipment.

Increase your braking confidence with
the available diesel exhaust brake, pg. 19.



Enjoy an impressive highway range with a 36-gallon fuel tank, pg. 19.

Haul more and still enjoy a smooth ride with multistage rear leaf springs, pg. 18 and pg. 20.



SIERRA 2500 DENALI HD INTERIOR IN EBDNY
shown with available equipment.

Get a warm welcome with a leather-
wrapped, heated steering wheel, pg. 12.



More music to your ears with Bose®
Centerpoint® surround sound system, pg. 14.

Control your environment with
dual-zone climate control, pg. 12.



COMFORT ZONE. Sierra Denali HD is a truck built by—and for—those who demand attention to detail. Its seating surfaces are trimmed in premium leather that's perforated for comfort. The front seats are heated, cooled and feature 12-way power adjustment. The gauge cluster integrates a Driver Information Center, putting valuable information in one place. Every surface says this is no ordinary truck. Every feature contributes to making Denali the ultimate Sierra.

FEATURES & BENEFITS

PROFESSIONAL GRADE:
YOUR USER'S GUIDE.

The following pages offer detailed insights into the driving, hauling and trailering benefits Sierra HD pickups provide. Sierra HD trucks don't simply happen. They are born of a strict adherence to engineering excellence. Every component is the result of never saying never to what's possible. And to make sure the strongest, most powerful and most capable Sierra HD pickups stay that way, we back them with Pro Grade Protection (see page 15 to learn more).



SIERRA 2500HD CREW CAB SLT IN ONYX BLACK
shown with available equipment.



Keep you and your trailer heading in the same direction with Trailer Sway Control, pg. 20.

Make it easier to get in and out of your Sierra with available accessory assist steps, pg. 24.

EXTERIOR FEATURES

LOADED EVEN BEFORE YOU LOAD IT. No matter which one you choose, Sierra 2500HD and Sierra 3500HD ingeniously combine brains and

brawn. They're equipped with features (as well as available options) that will help bring any job down to size, while making your travels feel nearly effortless.

The following are just a few of the features that make Sierra HD the heavy favorite in heavy dutys.

SIERRA 2500HD

1 SIERRA 2500 DENALI HD Our ¾-ton Sierra 2500 Denali HD sits on a fully boxed, high-strength steel frame specifically engineered for HD applications. With the available Duramax Diesel 6.6L V-8 Turbo, it has a trailering capacity of up to 17,400 lbs.¹

2 PAYLOAD AND TRAILERING Sierra 2500HD has a maximum payload of up to 4,212 lbs.² and with the available Duramax Diesel 6.6L V-8 Turbo, a maximum trailering capacity of up to 13,000 lbs¹ with a conventional ball hitch, or up to 17,800 lbs¹ with a fifth-wheel or gooseneck hitch.

3 FOLDING MIRRORS The outside mirrors fold to make it easier to navigate tight spaces. Available camper mirrors (shown at bottom right) extend to give you a wide view, and you can retract them when parking in narrow spaces.

4 RECIRCULATING BALL STEERING Sierra HD models feature recirculating ball power steering. The high-capacity power steering pump and large reservoir help to give a constant level of assist, even when operating at the maximum weight.





SIERRA 3500HD

5 SIERRA 3500 DENALI HD Our Sierra 3500 Denali HD is the ultimate expression of Professional Grade engineering. It offers an available maximum payload of up to 5484 lbs² and maximum trailering of up to 22,800 lbs¹ with the available Duramax Diesel 6.6L V-8 Turbo.

6 WIDE-VIEW MIRROR All 3500HD models come standard with vertical camper-style, convex spotter surface mirrors that help you see what's along your sides when you're trailering a wide load.

7 TRAILERING CAPACITY An impressive 1-ton maximum fifth-wheel trailering capacity of up to 23,100 lbs¹ and a GCWR of 30,500 lbs.³

PAYLOAD CAPACITY The 3500HD Regular Cab 2WD Long Box with dual rear wheels offers a maximum payload capacity of up to 7222 lbs.² If it's cargo and crew you need to haul, or a combination of both, the Sierra Crew Cab is a Sierra built for the heaviest of heavy-duty jobs.



¹Maximum trailer weight ratings are calculated assuming a base vehicle, except for any option(s) necessary to achieve the rating, plus driver. The weight of other optional equipment, passengers and cargo will reduce the maximum trailer weight your vehicle can tow. See your GMC dealer for additional details. ²Maximum payload capacity includes weight of driver, passengers, optional equipment and cargo. ³When properly equipped, includes weight of the vehicle and trailer combination, including the weight of driver, passengers, fuel, optional equipment and cargo in the vehicle and trailer.

INTERIOR FEATURES

BUSINESS CLASS. Climb into the cab of a Sierra HD and you'll quickly realize everything that surrounds you has been purpose-built for your needs.

From the integration of advanced technologies to the supportive seats to carefully calculated storage bins, Sierra HD's spacious interior is designed to put the driver in control and passengers at ease. After all, GMC engineers feel work shouldn't be without its comforts.



8 POWER FRONT SEATING Get comfortable with power-adjustable front seats. Power driver-seat adjustment is available for 40/20/40 seating with select equipment packages, and power driver and passenger seats are included with all bucket seats in SLE (six-way), SLT (10-way) and Denali (12-way).



9 HEATED AND COOLED FRONT SEATS The ultimate in all-weather comfort, these seats are appointed in a perforated leather that allows the cooling feature to circulate air between you and the seat surface. They are standard on Denali and available on SLT models.

POWER-ADJUSTABLE PEDALS To help drivers of varying sizes sit at a comfortable distance from the steering wheel, adjustable pedals with memory are available on SLE and SLT models, and are standard on Denali.

HEATED STEERING WHEEL Exclusive to Denali, the leather-wrapped, heated steering wheel adds soothing warmth whenever the driver demands it.

BLUETOOTH®¹ FOR PHONE Extend your capabilities by activating the available Bluetooth feature. This lets your Bluetooth device work through the vehicle's controls and features already installed in your Sierra HD, including hands-free operation and dialing.

¹Go to gmtotalconnect.com to find out which phones are compatible with the vehicle.

CLIMATE CONTROL All Sierra models are equipped with air conditioning. Automatic dual-zone climate control with individual settings for the driver and right-front passenger is standard on SLT and Denali, and available on SLE.

DRIVER INFORMATION CENTER Staying in touch with important vehicle information is as easy as pressing a button. The Driver Information Center includes the odometer and trip odometers, as well as a message center that includes vital vehicle functions and driving conditions. SLE, SLT and Denali include a compass and outside temperature indicator.

CONVENIENCE FEATURES

THAT'S EASY. Available on Sierra HD are a number of advanced features to enhance your level of convenience. Each helps transform ordinary tasks, like starting the vehicle, searching for a song and backing into a parking space, seamlessly integrating innovative technologies to create an exceptional driving experience. These are features you shouldn't leave home without.



10 REAR-VISION CAMERA SYSTEM Make it easier to back up to a trailer or negotiate a tight space. This available system places a monitor in your rearview mirror (or navigation screen, if equipped) to display a view of the area behind the vehicle. The Rear-Vision Camera does not replace driver vision. Please use proper care when backing up.



11 REMOTE VEHICLE START This available feature lets you start your vehicle from up to 195 feet away. Your Sierra HD will run for up to 10 minutes. If equipped with the automatic climate control system, it will default to heating or cooling mode based on the outside temperature.



12 UNIVERSAL HOME REMOTE Never get locked out again. This available remote can be easily programmed to operate the majority of garage-door-opening systems and has the benefit of never needing batteries.

ULTRASONIC REAR PARKING ASSIST This available system sends out ultrasonic waves that act like rear bumper radar to alert you to the distance of objects up to 8 feet behind the vehicle. The system operates at speeds less than 5 mph. The closer you are, the faster it beeps.



13 STEERING-WHEEL-MOUNTED RADIO CONTROLS Access your audio system with your fingertips while you keep your eyes on the road. These available fingertip controls can also manage most music search features of compatible MP3 and iPod® players, as well as Bluetooth² for phone.

²Go to gmttotalconnect.com to find out which phones are compatible with the vehicle.



ENTERTAINMENT

WORK HARD. PLAY HARD. Sierra HD is available with a range of entertainment technologies to enhance your drive. The quiet cabin is the ideal starting point for you and your passengers to enjoy available audio and the DVD Rear-Seat Entertainment System. Finding the information, music and video you want is easy thanks to steering-wheel and touch-screen controls at your fingertips.

14 BOSE® AUDIO SYSTEMS Bose audio is engineered to give you the realism and presence of a live performance. Standard on SLT and available on SLE models, Bose audio features steering-wheel-mounted radio controls and a premium speaker system.

BOSE CENTERPOINT® SOUND Denali models include Bose Centerpoint surround sound with SurroundStage® signal processing for the sensation of a live performance. This technology, along with AudioPilot® noise compensation, wraps you in sound, delivering five independent channels from existing two-channel recordings.

15 REAR-SEAT ENTERTAINMENT SYSTEM Available in SLT and Denali Crew Cab models, rear-seat passengers will enjoy this system that includes a DVD player and 8" diagonal flip-down screen. It also comes with a separate upper DVD slot in the radio to let front-seat passengers control the DVD or music playing behind them. It's compatible with most popular video gaming systems.

AUXILIARY INPUT This available feature accommodates most MP3 players and devices, including many smartphones. So you can bring the music and entertainment you love to your Sierra just by plugging in.

16 TOUCH-SCREEN NAVIGATION SYSTEM¹ For easy operation, the available system includes a large 7" diagonal in-dash touch-screen display, 2-D or 3-D map graphics and 3 months of NavTraffic.² OnStar³ subscribers can also use this system with OnStar Turn-by-Turn Navigation assistance (6 months standard). The screen also serves as a large, easily read monitor for the available Rear-Vision Camera System.

¹Map coverage for Puerto Rico and the U.S. Virgin Islands available on separate disc. Coverage not available for portions of Canada.
²If you subscribe after your trial period, *subscriptions are continuous until you call SiriusXM to cancel.* See SiriusXM Customer Agreement for complete terms and geographic limitations at siriusxm.com. Other fees and taxes will apply. All fees and programming subject to change. ³Visit onstar.com for coverage map, details and system limitations.

USB PORT⁴ Plug your digital devices into the available USB port in the center console.
⁴Not compatible with all devices.

SIRIUSXM SATELLITE RADIO/NAVTRAFFIC⁵ Enjoy SiriusXM Satellite Radio with a 3-month trial subscription to the XMPremier Package. Get over 130 channels, including commercial-free music, plus sports, news, talk, comedy and entertainment. With NavTraffic, you'll get continuously updated traffic information, right on your vehicle's available navigation system.

⁵If you subscribe after your trial period, *subscriptions are continuous until you call SiriusXM to cancel.* See SiriusXM Customer Agreement for complete terms and geographic limitations at siriusxm.com. Other fees and taxes will apply. All fees and programming subject to change.

ONSTAR FEATURES

FRIENDS IN HIGH PLACES

Standard for 6 months, the OnStar

Directions & Connections Plan⁶ lets you speak to a live OnStar Advisor just by pressing the blue OnStar button on your rearview mirror.

SAFETY

AUTOMATIC CRASH RESPONSE⁷ In many crashes, built-in sensors can automatically alert an OnStar Advisor who is immediately connected into your vehicle to see if you need help sent to your exact location—even if you can't respond.

CRISIS ASSIST During severe weather or other crisis situations, OnStar offers assistance to help you connect with loved ones and navigate your way to safety.

EMERGENCY SERVICES If someone in your Sierra HD needs emergency help, the OnStar emergency button gives you a priority connection to a specially trained Advisor at any time, day or night.

ROADSIDE ASSISTANCE⁸ If you're stranded, run out of gas or have a flat tire—one push of the OnStar button can immediately connect you to an Advisor, ready to help any hour of the day or night.

REMOTE DOOR UNLOCK⁹ If you get locked out of your Sierra HD, OnStar can help. An OnStar Advisor can send a signal to your Sierra HD that usually unlocks the doors within minutes.

REMOTE HORN AND LIGHTS Can't remember where you parked? Call the toll-free number and OnStar will send a signal to flash your lights and sound your horn to help you locate your Sierra HD.

STOLEN VEHICLE ASSISTANCE⁹ If your Sierra HD is ever stolen, OnStar can help locate it after verification with law enforcement.

CONNECTIONS

HANDS-FREE CALLING¹⁰ With voice-activated dialing, available OnStar Hands-Free Calling is built into your Sierra HD. Push the voice command button, call out the number and you're free to keep your eyes on the road.

TURN-BY-TURN NAVIGATION OnStar Turn-By-Turn Navigation is simple—all you have to do is push your blue OnStar button and ask the OnStar Advisor to download directions to your Sierra HD.

ONSTAR eNAV WITH MAPQUEST.COM™ Get a head start on a trip by checking out your destination on mapquest.com. With OnStar eNav, just click the "Send" link on the Web site, and directions will be sent to your vehicle.

DESTINATION DOWNLOAD With the optional Navigation System, simply press your blue OnStar button, and a trained Advisor will download directions to your Sierra HD's navigation screen.

ONSTAR REMOTELINK™ KEY FOB SERVICES¹² Unlock. Start. Find. From anywhere. New this year, OnStar RemoteLink Key Fob Services are included for 5 years on OnStar-equipped 2014 vehicles when you download the app and use RemoteLink services during the 6-month trial period and any consecutive periods with an OnStar plan. Services include remote door unlock and lock, remote start and stop (requires factory-installed remote start) and remote horn and lights.

GMC PRO GRADE PROTECTION

PROFESSIONAL GRADE COVERAGE.

To make sure GMC's Professional Grade engineering stays that way, Pro Grade Protection is now standard on every 2014 Sierra HD. From scheduled maintenance to protecting the entire vehicle and the powertrain in between, you can drive with confidence knowing that Professional Grade doesn't simply describe your Sierra HD's design and engineering, it's how well we protect it, too.

2-YEAR/24,000-MILE RECOMMENDED
SCHEDULED MAINTENANCE¹³

3-YEAR/36,000-MILE BUMPER-TO-BUMPER
LIMITED WARRANTY¹⁴

5-YEAR/100,000-MILE POWERTRAIN
LIMITED WARRANTY¹⁴

⁶Visit onstar.com for coverage map, details and system limitations. ⁷OnStar acts as a link to existing emergency service providers. Not all vehicles may transmit all crash data. ⁸Roadside service provided by Allstate Roadside Services. ⁹Services vary by model and conditions. ¹⁰Visit onstar.com for coverage map, details and system limitations. OnStar Hands-Free Calling requires existing OnStar service contract and prepaid minutes. Not available in certain markets. Calls can be made in U.S. and Canada only. ¹¹Available on select Apple,® Android™ and BlackBerry® devices. Services vary by device, vehicle and conditions. Requires an active OnStar subscription. ¹²Access is available for 5 years from the date of vehicle delivery and is transferable. Does not include any emergency services or other OnStar services. To cancel OnStar RemoteLink Key Fob Services or if your vehicle is sold, it is important to contact an OnStar Advisor. See onstar.com/mobile for full details. ¹³Covers only scheduled oil changes with filter, tire rotations and 27-point inspections, according to your new vehicle's recommended maintenance schedule for up to 2 years or 24,000 miles, whichever comes first. Does not include air filters. Maximum of 4 service events. See participating dealer for other restrictions and complete details. ¹⁴Whichever comes first. See dealer for limited warranty details.

HD ENGINES

POWER, PACKED. To make sure your heavy-duty work demands are accomplished with ease, Sierra 2500HD and 3500HD models offer Vortec gasoline and Duramax Diesel V-8 engines. No matter which you choose, you'll have plenty of what you demand from a heavy-duty pickup: power and torque.

VORTEC 6.0L V-8 ENGINE To give you uncompromised power and torque for confident daily driving, passing and trailering, look no further than the Vortec 6.0L V-8 engine. It uses innovative "vortex technology" to swirl and tumble incoming air and fuel for optimum power and response.

E85 FLEXFUEL CAPABILITY¹ The Sierra 6.0L gas V-8 engine is capable of running on E85 ethanol, an advanced biofuel.

¹E85 FlexFuel capability is not available in AZ, CA, CT, DE, MA, MD, ME, NJ, NY, OR, PA, RI, VT and WA. E85 is a combination of 85% ethanol and 15% gasoline. Go to afdc.energy.gov/afdc/fuels to see if there is an E85 fuel station near you.

VARIABLE VALVE TIMING (VVT) For easy responsiveness in low-speed city driving and bold power for open-road passing or trailering, the Vortec 6.0L V-8 features VVT. It monitors and changes valve open and close points for near-peak levels of torque across the entire range of engine speeds.

17 DURAMAX DIESEL 6.6L V-8 TURBO With direct-injection technology that helps it start in as little as 3.0 seconds at -30°F and a sophisticated Allison[®] transmission with overdrive, the available Duramax Diesel 6.6L gives you a maximum highway range of up to 650 miles on a single fill-up.²

²Based on GM testing and fuel-tank capacity. Your range may be less.

DURAMAX B20 BIODIESEL CAPABILITY To reduce carbon-dioxide emissions and stretch your fuel budget, the Duramax 6.6L can operate on B20 biodiesel, a mix of 20 percent biodiesel from domestic, renewable resources, and 80 percent petroleum diesel.

DURAMAX HIGH-PRESSURE DIRECT INJECTION

For fast starts in cold weather, quieter operation and maximum efficiency, the direct-injection system operates at nearly 30,000 psi to turn heavy diesel fuel into a fine mist, burning clean and fast with lower emissions.

CNG Dedicated Compressed Natural Gas (CNG) fuel systems are available on Sierra 2500HD Crew Cab models. CNG vehicles are equipped with a specially designed 6.0L Vortec engine built for gaseous fuel, along with an integrated and warranted dedicated gaseous fuel system in place.

OIL LIFE MONITOR For long life and durability, nothing is more important than changing your oil at the right time. GMC engineered the mystery out of this essential service with the Oil Life Monitor. It calculates how much life your oil has left, based on when and how you drive. Then, it updates you with a telltale on your Driver Information Center.

ONSTAR VEHICLE DIAGNOSTICS³ Standard with your 6-month trial subscription to OnStar, the OnStar Vehicle Diagnostics service can run hundreds of checks of your engine, transmission, antilock brakes and more, then organize the information into an easy-to-read monthly report. OnStar can also run a check of your vehicle as you drive just by pressing the blue button and asking the Advisor for an On-Demand Diagnostics check.

³Visit onstar.com for details and system limitations.



17

HEAVY-DUTY ENGINES

VORTEC 6.0L V-8 VVT (L96)

HORSEPOWER: 360 hp @ 5400 rpm⁴

TORQUE: 380 lb-ft @ 4200 rpm

FlexFuel Capable

⁴¼-ton models. See page 28 for full engine specifications.

DURAMAX DIESEL 6.6L V-8 TURBO

HORSEPOWER: 397 hp @ 3000 rpm

TORQUE: 765 lb-ft @ 1600 rpm

6.0L V-8 SFI BI-FUEL (LC8)

HORSEPOWER: 360 hp @ 5400 rpm (gasoline)

301 hp @ 5000 rpm (CNG)

TORQUE: 380 lb-ft @ 4200 rpm (gasoline)

333 lb-ft @ 4200 rpm (CNG)

TRANSMISSION / DRIVETRAIN

POWER, DELIVERED. A pickup truck's transmission and driveline components are critical to translating every rotation of the engine's crankshaft into power at the drive wheels—power to tow and haul, power to pass, power to grip snow-covered asphalt or gravel-strewn back roads. GMC Sierra HD offers a range of robust yet refined transmissions precisely matched to maximize the power delivery, efficiency and load demands of our HD engines.

EATON® HEAVY-DUTY AUTOMATIC LOCKING REAR DIFFERENTIAL No other competitor in its class offers an available fully automatic locking rear differential for on- and off-road use. Available on Sierra 2500HD and standard on 3500HD, the Eaton locker senses when there's a difference in rotational speed between the left and right rear wheels of approximately 100 rpm. It then locks the differential to turn both rear wheels in unison for added traction.

TOW/HAUL MODE To give you more power to accelerate, Tow/Haul mode raises transmission upshift points. This feature also helps you slow your Sierra by raising downshift points, which uses engine compression to slow your Sierra.

AUTOMATIC ENGINE GRADE BRAKING Standard with gas-engine 6-speed automatic transmissions, Grade Braking automatically senses when you want to slow your Sierra, and when the conditions are met, engages a Grade Braking shift schedule that helps you maintain your desired speed.

HEAVY-DUTY 6-SPEED AUTOMATIC WITH OVERDRIVE Sierra HD's Vortec 6.0L V-8 is mated to a 6-speed automatic with overdrive. It's a sophisticated tool featuring Tow/Haul mode, Driver Shift Control and Automatic Engine Grade Braking to help you use the full potential of Sierra HD.

DRIVER SHIFT CONTROL Move through the gears like a manual with the convenience of an automatic. Move the shift lever to "M," and you get fingertip "tap up/down" range control of transmission gear selection. Included with select automatic transmissions.



18

18 ALLISON® 1000 SERIES 6-SPEED AUTOMATIC WITH OVERDRIVE How do you handle the 765 lb-ft of torque produced by Sierra HD's available Duramax Diesel engine? GMC engineers specified the Allison 1000 Series 6-speed automatic with overdrive for its heavy-duty strength and durability. Designed by the same company that makes transmissions for military tanks, this transmission is the exclusive partner for the available Duramax Diesel engine.

AUXILIARY EXTERNAL TRANSMISSION OIL COOLER An air-to-oil auxiliary cooling unit helps keep transmission temperatures in check—especially critical when trailering or plowing snow.



CHASSIS AND CONTROL SYSTEMS

STRENGTH WITH SMARTS.

There's a critical difference between just driving a truck and commanding a GMC Sierra HD: its chassis and control systems. GMC engineers took the powerful drivetrains of Sierra and mounted them to a strong, rigid frame—built specifically for heavy-duty capabilities. Then they gave the chassis advanced control systems designed to make driving Sierra HD easier under the heaviest loads.



19 FULLY BOXED FRAME Crafted from high-strength steel, the HD frame is fully boxed along its entire length, with fully welded (not riveted) brackets and cross-members. Tubular cross-members are through-rail welded for significantly added strength and resistance to twisting over rough surfaces.

INDEPENDENT FRONT SUSPENSION For ride comfort without sacrificing strength, Sierra HDs have an independent front suspension designed specifically for the constant punishment of heavy-duty use. With a maximum unsurpassed pickup Gross Front Axle Weight Rating of up to 6000 lbs,¹ this torsion-bar suspension design allows you to make seasonal ride-height adjustments in minutes, with a single wrench.

¹Capabilities and weight ratings are dependent upon model, engine, transmission and GVWR combinations. See your GMC dealer for details.

20 MULTILEAF REAR SPRINGS To handle heavy-duty payloads, GMC engineers outfitted Sierra HD models with rear leaf springs that are 3 inches wide—two-stage for 2500HD models and three-stage for 3500HD models.

TORSION-BAR DESIGN The Sierra HD frame uses a torsion-bar suspension. Pioneered for pickups by GMC, the torsion bar is designed to support different front axle loads and to retain proper trim height.

STABILITRAK A stability control system that's standard on all Single Rear Wheel (SRW) Sierra models, StabiliTrak senses when your vehicle is not responding to steering inputs and adjusts engine speed and applies brake pressure to any individual wheel to help maintain directional control.

TRACTION CONTROL SYSTEM To make the most of available traction on many road surfaces, traction control measures and compares the speed of your wheels. If it senses one or more wheels starting to spin, such as on a slippery surface, the system applies individual brakes and manages engine power to slow the wheel down and maintain traction so you can move forward with a better sense of control.

HEAVY-DUTY POWER STEERING
Sierra HD models feature recirculating ball power steering. The high-capacity power steering pump and large reservoir help give a constant level of assist, even when operating at the maximum weight.

DIESEL EXHAUST BRAKE To let you engage an extra measure of braking confidence on long grades, the diesel exhaust brake, included with the available Duramax Diesel engine, uses engine compression to create “negative torque” to help slow the vehicle. It’s factory installed and calibrated to work with the rest of your Sierra HD’s braking system.

HYDRAULIC BODY MOUNTS How do you balance the demand for a rigid frame with desire for cabin comfort? GMC engineers positioned the Sierra HD Crew Cab models on rear mounts filled with hydraulic fluid, creating a smooth, quiet ride.

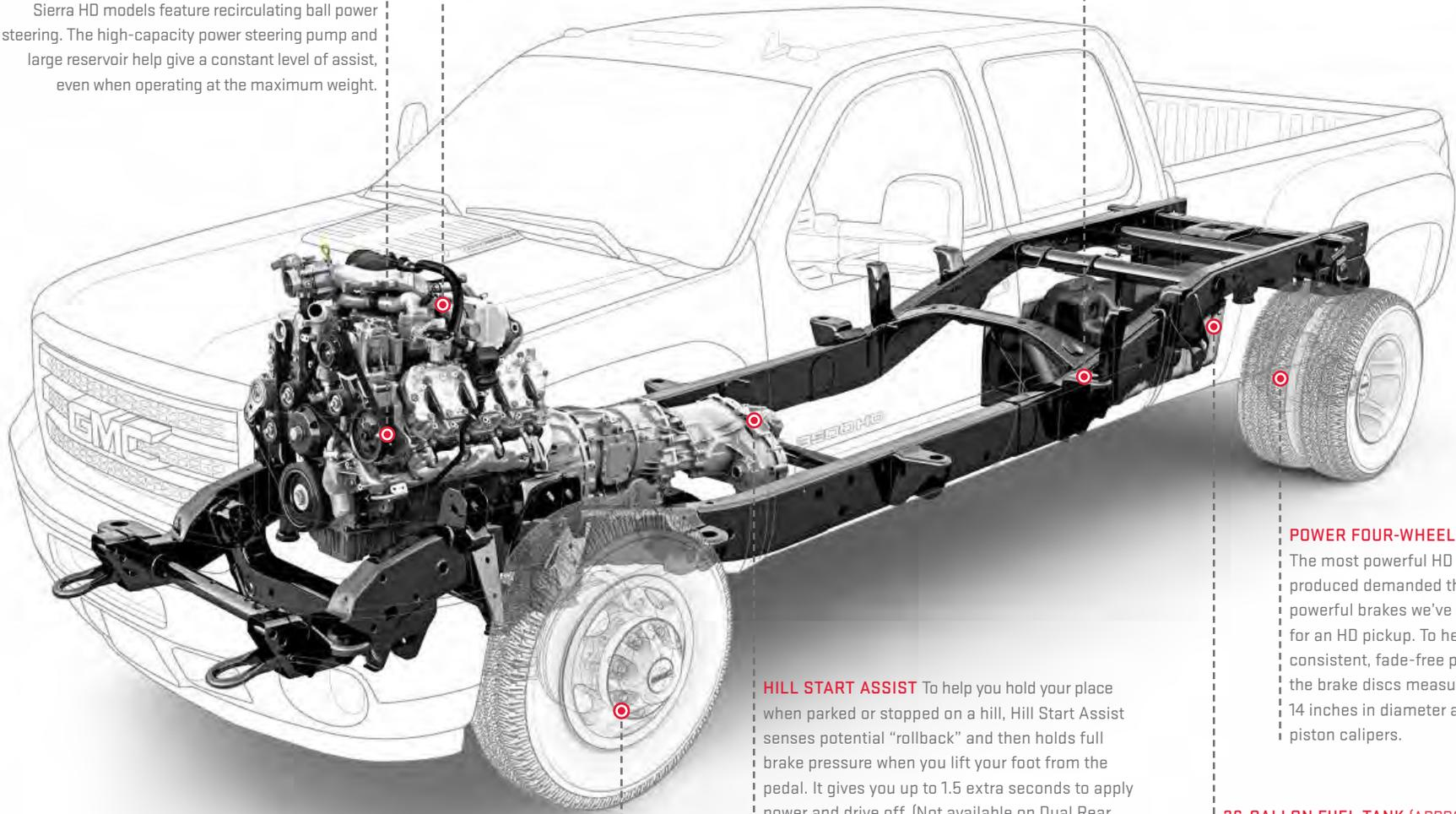

ANTILOCK BRAKING SYSTEM (ABS)
For confident stops in a variety of conditions, every SRW Sierra HD features four-channel antilock brakes. When the brakes are applied, ABS detects impending wheel lock-up and pulses that wheel's brake to prevent it. The system can activate any combination of vehicle brakes to maintain control.

HILL START ASSIST To help you hold your place when parked or stopped on a hill, Hill Start Assist senses potential “rollback” and then holds full brake pressure when you lift your foot from the pedal. It gives you up to 1.5 extra seconds to apply power and drive off. (Not available on Dual Rear Wheel [DRW] models.)

INTELLIGENT BRAKE ASSIST In an abrupt stop, milliseconds can be your margin of safety. That's why Sierra's Intelligent Brake Assist senses when you're making an emergency stop, then automatically applies full braking force before your foot can press the pedal all the way. (Not available on DRW models.)

POWER FOUR-WHEEL DISC BRAKES
The most powerful HD we've ever produced demanded the most powerful brakes we've ever developed for an HD pickup. To help ensure consistent, fade-free performance, the brake discs measure a generous 14 inches in diameter and utilize twin-piston calipers.

36-GALLON FUEL TANK (APPROX.) When equipped with the available Duramax Diesel, Sierra HD has a highway range of up to 680 miles on a single tank of fuel,² thanks to its 36-gallon fuel tank.

²Based on GM testing and fuel-tank capacity. Your range may be less.

TRAILERING

HEAVY EMPHASIS ON MORE. GMC Sierra HD is engineered to offer Professional Grade trailering capability to tow more and thus do even more—

in fact, 2500HD and 3500HD provide the most standard trailering in their class. Whether you're headed out for work or recreation, Sierra HD offers a wide range of trailering capacities to meet your demands. Complete trailering ratings to help you make an informed purchase decision are listed on page 28.

21 MULTISTAGE REAR LEAF SPRINGS For more capacity when you need it and a smoother ride when you don't, Sierra HD's 3"-wide multileaf rear springs engage progressively as the load in the bed or on the hitch increases. In 2500HD, it's a two-stage progression, and on 3500HD, it's three-stage for added load-bearing capacity.

22 TRAILER SWAY CONTROL Keep you and your trailer heading in the proper direction, automatically. This system uses StabiliTrak sensors to detect a swaying trailer and applies the vehicle's and the trailer's brakes (if properly equipped) to help bring it back in line. (Not available on Dual Rear Wheel [DRW] models.)

23 TRAILER BRAKE CONTROLLER For fingertip control and easy monitoring of your trailer brakes, Sierra HD offers an integrated trailer brake controller. It's located close to the steering wheel for easy adjustments and displays the level of brake force or "gain" in the Driver Information Center. (Standard on 3500HD models.)

FIFTH-WHEEL FRAME MOUNT PROVISIONS Sierra HD models offer easy installation of fifth-wheel and gooseneck hitches. GMC engineers added prepierced access holes to preserve frame integrity, as well as a pair of extra cross-members for added strength in the hitch-mount location.

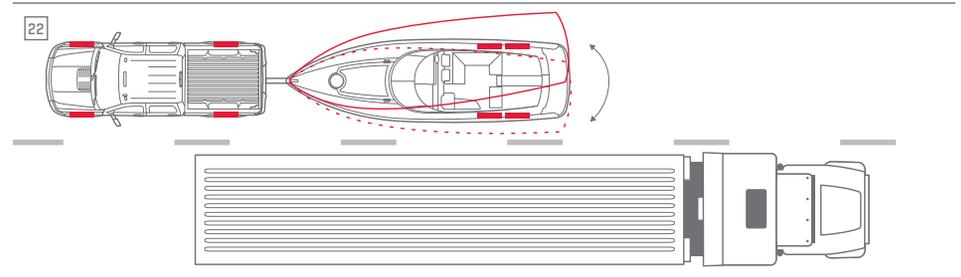

MAXIMUM TRAILER WEIGHT RATINGS¹

2500HD	Up To 17,800 lbs
3500HD	Up To 23,100 lbs

Complete trailering ratings are listed on page 28.

¹Maximum trailer weight ratings are calculated assuming a base vehicle, except for any option(s) necessary to achieve the rating, plus driver. The weight of other optional equipment, passengers and cargo will reduce the maximum trailer weight your vehicle can tow. See your GMC dealer for additional details.

SAFETY

YOU CAN NEVER BE TOO SAFE. Sierra HD is designed to help protect you before, during and after a collision. Advanced chassis control technologies help Sierra HD drivers avoid potential accidents. A system of air bag supplemental restraints² helps protect passengers during a collision. With the available OnStar Automatic Crash Response³ (standard for 6 months), Sierra HD can even connect you to help in the critical moments immediately after you're involved in a crash.

24 FRONTAL AND HEAD CURTAIN SIDE-IMPACT AIR BAGS² All Sierra HD models come with driver and front-passenger air bags. Available side-impact air bags unfurl from the roof rail like a protective curtain for outboard passengers and can be activated by either rollover sensors or side-impact sensors. (Standard on Denali models.)

25 SEAT-MOUNTED SIDE-IMPACT AIR BAGS² To help protect the thorax and pelvic regions of the driver and outside front passenger in a side-impact collision, Sierra Heavy Duty Denali models include side-impact air bags mounted on the driver and outside front-passenger seat. (Also available on other select Heavy Duty models.)

LATCH CHILD SEAT ANCHORING SYSTEM Make it easier to properly install a child seat. LATCH stands for Lower Anchors and Top tethers for CHildren. A LATCH seat will install to specially designed retainer hooks in your Sierra HD with an audible "click." You can also install a top tether strap that helps limit movement in a forward crash to help reduce the chance of injury.



REINFORCED STEEL SAFETY CAGE DESIGN Sierra HD's robust body structure is engineered to help maintain the integrity of the passenger compartment in the event of a collision. All steel from wheel to wheel, the body is designed to crush in a controlled manner in the event of a collision, absorbing the energy of a crash as much as possible.

PASS-KEY III+ THEFT DETERRENT SYSTEM Preventing unauthorized starting attempts in your Sierra HD comes down to a tiny chip found in your ignition key. It functions as an electronic "fingerprint" that disables your starting system if it detects a theft attempt is under way.

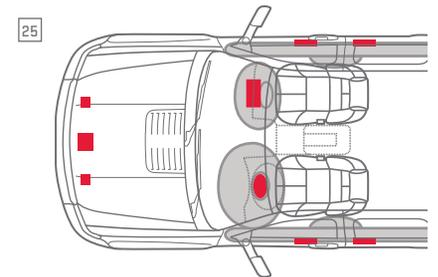

²Air bag inflation can cause severe injury or death to anyone too close to the air bag when it deploys. Be sure every occupant is properly restrained. Always use safety belts and the correct child restraint for your child's age and size, even with air bags. Even in vehicles equipped with the Passenger Sensing System, children are safer when properly secured in a rear seat in the appropriate infant, child or booster seat. Never place a rear-facing infant restraint in the front seat of any vehicle equipped with an active frontal air bag. See your vehicle Owner's Manual and child safety seat instructions for more safety information. ³Visit onstar.com for coverage map, details and system limitations. OnStar acts as a link to existing emergency service providers. Not all vehicles may transmit all crash data.

SELECTION

AFTER ALL, IT IS YOUR SIERRA HD. Like every GMC, Sierra HD is built to the strictest standards for engineering, performance and capability.

Yet, the benchmark that means the most to us is yours. So, to make sure it's exactly the way you want it, this is your opportunity to make several important selections.

You'll find numerous choices in exterior, interior, entertainment, performance and accessory options. Build your Sierra HD to reflect your preferences.

INTERIOR COLORS

VINYL

[Standard: WT]



PREMIUM CLOTH

[Standard: SLE]



LEATHER-APPOINTED

[Standard: SLT; Available: SLE]



PERFORATED LEATHER-APPOINTED

[Standard: Denali; Available: SLT]



CLOTH

[Available: WT]

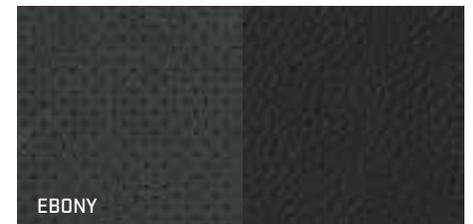
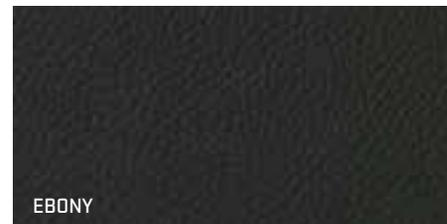
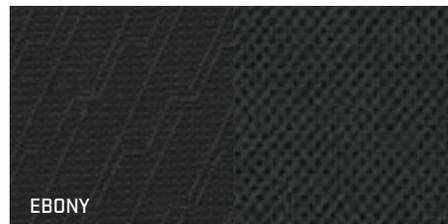
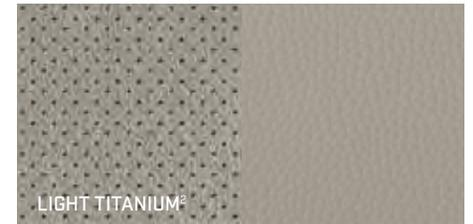
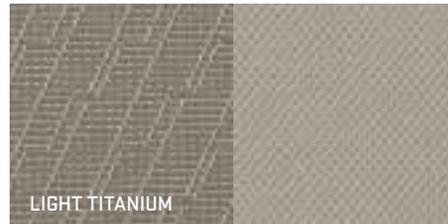
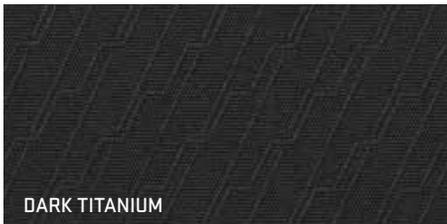

¹Very Dark Cashmere/Light Cashmere on SLT. ²Not available on Denali.

EXTERIOR COLORS

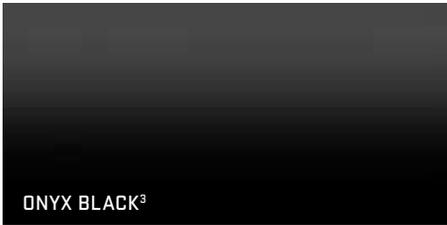

All colors are basecoat/clearcoat for high gloss and durable finish. See your dealer for more details on paint and color availability. ³Available on Denali.

WHEELS

2500HD WHEELS



PYN
17" PAINTED STEEL
STANDARD: WT



PYQ
17" CAST-ALUMINUM
BRIGHT MACHINED
STANDARD: SLE
AVAILABLE: WT



PYS
20" ALUMINUM
AVAILABLE: SLE AND SLT

2500HD/3500HD SRW WHEELS



PYT
18" PAINTED STEEL
STANDARD: 3500HD WT
AVAILABLE: 2500HD WT



PYR
18" FORGED POLISHED
ALUMINUM
STANDARD: 2500HD SLT,
3500HD SLE AND SLT
AVAILABLE: 2500HD SLE

DENALI HD SRW WHEELS



PYR
18" FORGED POLISHED
ALUMINUM
STANDARD: 2500 AND
3500 DENALI HD



PYS
20" ALUMINUM
AVAILABLE: 2500 DENALI HD

3500HD DRW WHEELS



PYW
17" PAINTED STEEL
STANDARD: WT



P06
17" CHROME SKINS
AND CENTER CAPS
STANDARD: SLE AND SLT



RS7
17" FORGED POLISHED
ALUMINUM
STANDARD: 3500 DENALI
HD DRW
AVAILABLE: 3500HD SLE
AND SLT DRW

BUT WAIT, THERE'S MORE. Engineered to the same standards as your Sierra HD, available GMC Accessories range from functional enhancements

like assist steps and bed management systems to a stylish array of accents. So go ahead, outfit your Sierra HD exactly the way you want it.



1

1 ASSIST STEPS Make it easier to get in and out of your truck with these stylish assist steps. Crafted from rust-resistant stainless steel, they are available in either chrome or black powder coat and in 6-inch oval or 3-inch round styles.



2

2 INTEGRATED DVD A dual-player DVD system mounted in back of each front head restraint with wireless headphones gives rear-seat passengers personal entertainment. Single remote control included.



3

3 BED RAIL CAPS Give the rails on your Sierra HD's pickup bed extra protection against wear and tear with these tough-as-nails rail caps.

SOFT TONNEAU COVER Roll-up design shields cargo, easily rolls up to allow full access to the bed and is constructed with integrated crossbows.



4

4 STATIONARY TOOLBOX Diamond-patterned toolbox features dual gas shocks for smooth opening and closing and the GMC logo.

VEHICLE SPECIFICATIONS

WT
SLE
SLT
DENALI

TRIM LEVELS

CONFIGURATIONS	WT	SLE	SLT	DENALI
Regular Cab	●	●	–	–
Crew Cab	●	●	●	●
MECHANICAL SIERRA 2500HD/3500HD				
ALTERNATOR 125-amp	●	●	●	●
160-amp. Included with Snow Plow Prep Package when Vortec 6.0L SFI V-8 is ordered. Requires Vortec 6.0L SFI V-8.	○	○	○	○
Dual, 125 amps each. Included with Snow Plow Prep Package when Duramax Diesel 6.6L V-8 Turbo is ordered. Requires Duramax Diesel 6.6L V-8 Turbo engine.	○	○	○	○
BATTERY Heavy-duty, maintenance-free with 600 cold-cranking amps, rundown protection and retained accessory power	●	●	●	●
Auxiliary heavy-duty, maintenance-free with 600 cold-cranking amps. Not available with Duramax Diesel 6.6L V-8 Turbo engine.	○	○	○	○
Heavy-duty, 2 batteries, maintenance-free with 730 cold-cranking amps, with rundown protection and retained accessory power. Included and only available with Duramax Diesel 6.6L V-8 Turbo engine.	○	○	○	○
BRAKES Power 4-wheel disc, 4-wheel antilock	●	●	●	●
EATON® HEAVY-DUTY AUTOMATIC LOCKING REAR DIFFERENTIAL Included with Heavy-Duty Trailing Package. Standard on all 3500HD pickup models.	○	○	●	●
ENGINE Vortec 6.0L V-8 VVT FlexFuel with SFI	●	●	●	●
Duramax Diesel 6.6L V-8 Turbo with direct injection and B20 biodiesel capability	○	○	○	○
ENGINE BLOCK HEATER	○	○	○	○
ENGINE OIL COOLER Heavy-duty external air-to-oil. Integral to driver side of radiator tank.	●	●	●	●
EXHAUST Aluminized stainless steel	●	●	●	●
EXHAUST BRAKE Included with Duramax Diesel 6.6L V-8 Turbo engine only	○	○	○	○
FRAME Fully boxed with hydroformed front section	●	●	●	●
10,000-lb GVWR ² package. Select Sierra 3500HD SRW models. See your dealer for details.	○	○	○	○
HIGH-CAPACITY AIR CLEANER	●	●	●	●
HIGH IDLE SWITCH	○	○	○	○
RADIATOR GRILLE AND FRONT BUMPER OPENINGS COVER For cold weather. Requires Duramax Diesel 6.6L V-8 Turbo engine.	○	○	○	○
REAR AXLE 4.10 ratio. Requires Vortec 6.0L V-8 engine.	●	●	●	●
3.73 ratio	○	○	○	○
SKID PLATE PACKAGE Frame-mounted shields. Includes front underbody shield starting behind front bumper and running to first cross-member, protecting front underbody, oil pan, differential case and transfer case. Requires 4WD on WT models. Not available on 2WD SLE and SLT models unless Z71 Off-Road Suspension Package is ordered.	○	○	○	●
SNOW PLOW PREP PACKAGE Includes 10-amp power for back-up and roof emergency light, 160-amp alternator (dual 125 amp included with diesel), high-flow front bumper, forward lamp wiring harness, provision for cab roof-mounted lamp/beacon, instrument panel jumper wiring harness for electronic trailer brake controller, Skid Plate Package (4WD models only) and increased Front Gross Axle Weight Rating (FGAWR). See chart on page 27 for more details.	○	○	○	○
STABILITRAK Stability control system. Includes electronic trailer sway control, Intelligent Brake Assist and Hill Start Brake Assist (SRW models only).	●	●	●	●
STEERING Power, recirculating ball	●	●	●	●

KEY ● STANDARD ○ AVAILABLE – NOT AVAILABLE

TRIM LEVELS

SUSPENSION Front independent with torsion bar	●	●	●	●
Rear multileaf springs, semielliptic with urethane jounce bumpers	●	●	●	●
HEAVY-DUTY HANDLING/TRAILERING SUSPENSION PACKAGE	●	●	●	●
Z71 OFF-ROAD SUSPENSION PACKAGE Includes off-road jounce bumpers, off-road 35-mm deflective disk twin-tube shock absorbers, 33-mm front stabilizer bar, Skid Plate Package and Z71 decals on rear quarters	–	○	○	○
HEAVY-DUTY TRAILERING PACKAGE Includes trailering hitch platform and 2.5" receiver with 2" adapter, 7-wire harness with independent fused trailering circuits mated to a 7-way sealed connector, wiring harness for aftermarket trailer brake controller (located in the instrument panel harness) and integrated trailer brake controller. Standard on all 3500HD models.	○	○	●	●
Integrated trailer brake controller. Requires Heavy-Duty Trailing Package. Standard on all 3500HD models.	○	○	●	●
Trailing wiring provisions for camper, fifth-wheel and gooseneck trailers; includes additional 8-way wiring harness routed to front of pickup box. Requires Heavy-Duty Trailing Package.	○	○	○	○
TRAILER SWAY CONTROL SRW models only	●	●	●	●
TRANSFER CASE With floor-mounted shifter (4WD models)	●	–	–	–
Electronic shift with rotary dial controls (4WD models)	–	●	●	●
TRANSMISSION 6L90-E 6-speed automatic. Standard and only available with Vortec 6.0L V-8.	●	●	●	●
Allison® 1000 Series 6-speed automatic. Included and only available with Duramax Diesel 6.6L V-8 Turbo.	○	○	○	○
TRANSMISSION OIL COOLER Auxiliary external heavy-duty air-to-oil	●	●	●	●

SEATING – ALL MODELS

SEATS 40/20/40 front split bench with driver and front-passenger manual recline and center fold-down armrest with storage	●	–	–	–
40/20/40 front split bench with driver and front-passenger manual recline. Center fold-down armrest and lockable storage compartment in seat cushion (includes auxiliary power outlet). Adjustable outboard head restraints on Crew Cab model.	–	●	–	–
Front buckets with 6-way power seat adjusters, manual recline, manual lumbar and adjustable head restraints. Requires Crew Cab model.	–	○	–	–
Front buckets with 10-way power seat adjusters (SLT) or 12-way (Denali) including power lumbar control, heated seat cushions and seatbacks, 2-position driver memory (does not apply to lumbar adjuster on SLT) and adjustable head restraints. Includes floor console and storage pockets.	–	–	●	●
Heated and cooled perforated leather-appointed seating with 12-way seat adjuster for driver and front passenger. Includes seat-mounted side-impact air bags ³ on SLT and Denali HD SRW models.	–	–	○	●
Driver-side manual seat adjuster with lumbar control. On WT models, included and only available with Dark Titanium Cloth seat trim.	○	●	–	–
60/40 folding rear bench. WT and SLE require Crew Cab model.	●	●	●	●
SEAT TRIM Dark Titanium vinyl with Graphite-colored rubberized-vinyl floor covering	●	–	–	–
Dark Titanium Cloth	○	–	–	–
Premium Cloth	–	●	–	–
Front leather-appointed seating. Includes 6-way power driver seat adjuster on SLE models. Not available on Regular Cab models.	–	○	●	–
Premium front Nuance leather-appointed seating	–	–	–	●

²When properly equipped; includes weight of vehicle, passengers, cargo and equipment. ³Always use safety belts and the correct child restraint for your child's age and size, even with air bags. Even in vehicles equipped with the Passenger Sensing System, children are safer when properly secured in a rear seat in the appropriate infant, child or booster seat. Never place a rear-facing infant restraint in the front seat of any vehicle equipped with an active frontal air bag. See your vehicle Owner's Manual and child safety seat instructions for more safety information.

TRIM LEVELS

INSTRUMENTATION AND CONTROLS—ALL MODELS

CRUISE CONTROL	● ● ● ●
INSTRUMENTATION Analog cluster with speedometer, fuel level, engine temperature and tachometer. On SLE, SLT and Denali models, includes voltmeter and oil pressure indicators.	● ● ● ●
Driver Information Center with odometer, trip odometer and message center. On SLE, SLT and Denali models, includes compass and outside temperature.	● ● ● ●
POWER-ADJUSTABLE PEDALS Requires Convenience Package	— ○ ○ ●
REAR-VISION CAMERA SYSTEM With inside rearview mirror display; if Touch-Screen Navigation ¹ is ordered, camera display is on NAV screen. Requires locking tailgate. On SLE model, also requires SLE Preferred Package. Not available on Regular Cab models.	— ○ ○ ●
STEERING WHEEL Tilt-Wheel adjustable steering column with brake/transmission shift interlock. Leather-wrapped [color-keyed on Denali]. On WT model, requires Bluetooth. ^{®2}	● ● ● ● ○ ● ● ●
Steering-wheel-mounted audio controls. On WT model, requires Bluetooth. ² On SLE model, requires Preferred Package.	○ ○ ● ●
Heated, leather-wrapped and color-keyed	— — — ●
ULTRASONIC REAR PARKING ASSIST With audible warning. Requires Crew Cab model and Convenience Package.	— ○ ○ ●

INTERIOR DETAILS—ALL MODELS

CARPETING Color-keyed with rubberized-vinyl floor mats. Crew Cab models also include rear floor mats; WT models require Dark Titanium Cloth seat trim.	○ ● ● —
Color-keyed with removable carpeted floor mats for first and second rows	— — — ●
CLIMATE CONTROL Single-zone manual air conditioning	● ● — —
Dual-zone automatic air conditioning with individual settings for driver and right-front passenger; not available with Regular Cab models. Requires Preferred Package.	— ○ ● ●
DEFOGGER Rear window. Not available with power-sliding rear window.	○ ○ ● ●
FLOOR COVERING Rubberized vinyl	● ○ — —
REARVIEW MIRROR With manual day/night adjustment	● ● — —
Auto-dimming. Standard on SLE 3500HD models.	— ○ ● ●
SUNROOF Power with express-open. Includes Universal Home Remote. Crew Cab models only.	— — ○ ○
WINDOWS Power with driver express-down. SLT and Denali models include front passenger express-down. Rear, power-sliding. Not available on Regular Cab models or with rear-window defogger.	— ● ● ● — ○ ○ ○

KEY ● STANDARD ○ AVAILABLE — NOT AVAILABLE

OPTION PACKAGES—SIERRA 2500HD/3500HD

WORK TRUCK PREFERRED PACKAGE Includes Solar-Ray deep-tinted glass, EZ-Lift locking tailgate, chrome grille with chrome surround and fog lamps. On 2500HD models, includes 17" chrome-clad steel wheels. Also includes power door locks and remote keyless entry on Regular Cab models.	○ — — —
SLE PREFERRED PACKAGE (REGULAR CAB) Includes remote vehicle start system, steering-wheel-mounted controls, Bluetooth ² for your cell phone, CD/MP3 player, fog lamps and EZ-Lift locking tailgate	— ○ — —
SLE PREFERRED PACKAGE (CREW CAB) Includes steering-wheel-mounted controls, dual-zone automatic air conditioning, 6-way power driver seat adjuster, Bluetooth ² for your cell phone, CD/MP3 player, fog lamps and EZ-Lift locking tailgate	— ○ — —
SLE PREMIUM PACKAGE (CREW CAB) Includes 20" forged polished-aluminum wheels on 2500 models, outside heated power-adjustable vertical camper mirrors, heavy-duty trailering equipment, heavy-duty automatic locking rear differential, dual-zone automatic air conditioning, Bluetooth ² for your cell phone, steering-wheel-mounted audio controls, AM/FM stereo with CD player and MP3 playback, driver 6-way power seat adjuster, front fog lamps, EZ-Lift locking tailgate, inside rearview auto-dimming mirror, 6" oval chromed tubular assist steps, bodyside moldings with chrome accents and chrome door handles. On Dual Rear Wheel Crew Cab models, includes 17" (RS7) forged polished-aluminum wheels. Not available with SLE Preferred Package.	— ○ — —
SLE CONVENIENCE PACKAGE Includes power-adjustable pedals, Universal Home Remote, remote vehicle start system, rear-window defogger and Ultrasonic Rear Parking Assist	— ○ — —
SLT CONVENIENCE PACKAGE Includes Universal Home Remote, power-adjustable pedals, EZ-Lift locking tailgate, Ultrasonic Rear Parking Assist and rear wheelhouse liners [dealer installed]	— — ○ —

ENTERTAINMENT/COMMUNICATION/NAVIGATION—ALL MODELS

AM/FM STEREO With seek-and-scan and digital clock	● — — —
With MP3-compatible CD player	○ ● — —
With CD player and MP3 playback, USB port ³ and auxiliary input jack. On SLE models, requires SLE Preferred Package.	— ○ ● —
With MP3-compatible 6-disc CD player, USB port ³ and auxiliary input jack	— — ○ ●
With MP3-compatible CD/DVD player and USB port. ³ On SLT models, requires Crew Cab model and Rear-Seat Entertainment Package. On Denali models, requires Rear-Seat Entertainment Package.	— — ○ ○
TOUCH-SCREEN NAVIGATION¹ With CD or DVD player and MP3 playback, color touch-screen display, enhanced HDD-based navigation with voice recognition, memory available for music storage, USB port, ³ Radio Data System [RDS] ⁴ and pause/play radio. Touch-Screen Navigation with DVD player requires Rear-Seat Entertainment Package.	— — ○ ○
BOSE[®] AUDIO PREMIUM SPEAKER SYSTEM WITH SUBWOOFER On SLE models, requires front bucket seats and SLE Preferred Package	— ○ ● ●
Centerpoint [®] Surround Sound System	— — — ●
REAR-SEAT ENTERTAINMENT PACKAGE Rear-seat DVD player with LCD display and 2 sets of wireless headphones. Includes rear audio controls. Requires Crew Cab model. On SLT models, includes CD/DVD player. Upgradable to CD/DVD player with navigation. On Denali models, requires CD/DVD player or CD/DVD player and HDD-based navigation.	— — ○ ○
SIRIUSXM SATELLITE RADIO⁵ Including 3 trial months of service	○ ● ● ●
NAVTRAFFIC⁶ Including 3 trial months of service. Included and only available with Touch-Screen Navigation. ¹	— — ○ ○
BLUETOOTH FOR PHONE² Personal cell-phone connectivity to vehicle audio system allowing hands-free calling	○ ○ ● ●
ONSTAR⁶ Directions & Connections Plan. 6-month subscription.	○ ● ● ●

CONVENIENCE FEATURES—ALL MODELS

POWER DOOR LOCKS With remote keyless entry (2 transmitters, panic button and content theft alarm). Remote keyless entry does not lock/unlock tailgate. Standard on Crew Cab models.	○	●	●	●
REMOTE START With remote keyless entry	—	○	●	●
UNIVERSAL HOME REMOTE	—	○	○	●

EXTERIOR STYLING AND FUNCTIONALITY—ALL MODELS

BODYSIDE MOLDINGS Body-colored. Chrome insert on Denali models. Not available on Regular Cab DRW models.	—	●	●	●
BUMPERS Chrome. On Sierra WT models, includes black bumper top caps. On SLE and SLT models, includes body-color bumper top caps.	●	●	●	—
Front, body-colored	—	—	—	●
Rear, chrome step-style with pad	●	●	●	—
Rear, body-colored step-style with pad	—	—	—	●
DOOR HANDLES Chrome	—	—	—	●
EZ-LIFT LOCKING TAILGATE	○	○	○	●
FRONT LICENSE PLATE BRACKET Included in all states that require a front license plate	○	○	○	○
GLASS Solar-Ray deep tinted	○	●	●	●
GRILLE Chrome grille surround with black horizontal bars. WT models only.	●	—	—	—
Chrome grille surround with chrome horizontal bars. On WT models, requires Work Truck Preferred Package. On Denali models, includes unique chrome upper and lower.	○	●	●	●
LIGHTS Halogen front fog lamps. On WT and SLE models, requires Preferred Package.	○	○	●	●
Dual cargo area lamps	●	●	●	●
RECOVERY HOOKS Front, frame-mounted	●	●	●	●
SPRAY-IN BEDLINER Available on Crew Cab Standard and Long Box models only	○	○	○	○
TIRE CARRIER Outside spare, winch-type	●	●	●	●
WIPERS Wet-arm front intermittent	●	●	●	●

OUTSIDE MIRRORS—ALL MODELS

Manual-folding, black (2500HD model)	●	—	—	—
Heated power-adjustable, manual-folding, black (2500HD models only)	○	●	—	—
Heated power-adjustable/power-folding. With integrated turn signal indicators and driver-side auto-dimming; body-color. Not available on 3500HD models.	—	○	●	●
VERTICAL CAMPER Manual-folding with lower convex spotter glass. Standard on 3500HD models. Available on 2500HD models.	○	—	—	—
Heated, power-adjustable with integrated turn signal indicators; manual-folding/extension; black (convex glass is not heated or power adjustable). SLE 2500HD models require inside rearview auto-dimming mirror or inside rearview auto-dimming mirror with camera display. Standard on 3500HD SLE, SLT and Denali models.	—	○	○	○

KEY ● STANDARD ○ AVAILABLE — NOT AVAILABLE

SAFETY

AIR BAGS ⁷ Frontal, includes driver and front passenger single-stage air bags	●	●	●	●
Head curtain, front and rear, side-impact	○	○	○	●
2500HD models. On SLT models, requires heated and cooled leather-appointed seating.	○	○	○	●
3500HD models (SRW only)	○	○	○	●
Seat-mounted, thorax and pelvic, side-impact for driver and outboard front passenger	○	○	○	●
2500HD models	○	○	○	●
3500HD models (SRW only)	○	○	○	●
TIRE PRESSURE MONITORING SYSTEM Does not monitor spare tire. Standard on 3500HD models with GVWR ⁸ less than 10,000 lbs.	●	●	●	●
DAYTIME RUNNING LAMPS With automatic lamp control	●	●	●	●

SIERRA AXLE RATINGS AND PLOW WEIGHTS

FRONT GROSS AXLE WEIGHT RATING (FGAWR) WITH SNOW PLOW PREP PACKAGE (4WD MODELS ONLY)

BODY	ENGINE RPO	ENGINE TYPE	2500HD	3500HD SRW	3500HD DRW
Regular Cab	L96	Gas	5200	5600	5600
	LML	Diesel	6000	6000	6000
Crew Cab Standard Box (includes Denali)	L96	Gas	5200	5600	—
	LML	Diesel	6000	6000	—
Crew Cab Long Box (includes Denali)	L96	Gas	5600	5600	5600
	LML	Diesel	6000	6000	6000

MAXIMUM PLOW WEIGHTS (4WD MODELS ONLY)

BODY	ENGINE RPO	ENGINE TYPE	2500HD	3500HD SRW	3500HD DRW
Regular Cab	L96	Gas	100/925	100/1000	100/1000
	LML	Diesel	100/1000	100/975	100/875
Crew Cab Standard Box (includes Denali)	L96	Gas	100/850	100/1000	—
	LML	Diesel	100/1000	100/875	—
Crew Cab Long Box (includes Denali)	L96	Gas	100/1000	100/1000	100/925
	LML	Diesel	100/825	100/775	100/700

SRW=Single Rear Wheel DRW=Dual Rear Wheel 100/xxx=100 lbs maximum of permanently attached snow plow mounting hardware/xxx lbs maximum of removable snow plow blade and blade hardware. Maximum plow weights based on a vehicle with average manufacturer option content and 150 lbs each for driver and one additional front-seat occupant. Additional equipment and occupants will reduce maximum plow weight. Rear compensating weight may be required to maintain front axle weight below 65% of total vehicle weight when equipped with snow plow. Consult your snow plow manufacturer for specific compensating weight recommendation.

¹Map coverage for Puerto Rico and the U.S. Virgin Islands available on separate disc. Coverage not available for portions of Canada. ²Go to gmttotalconnect.com to find out which phones are compatible with the vehicle. ³Not compatible with all devices. ⁴RDS functions only where stations broadcast RDS information. ⁵If you subscribe after your trial period, *subscriptions are continuous until you call SiriusXM to cancel.* See SiriusXM Customer Agreement for complete terms at siriusxm.com. Other fees and taxes will apply. All fees and programming subject to change. For more information about NavTraffic, visit siriusxm.com/navtraffic. For more information about Travel Link, visit siriusxm.com/travellink. XM satellite service is available only to those in the 48 contiguous USA and DC. ⁶Visit onstar.com for details and system limitations. ⁷Always use safety belts and the correct child restraint for your child's age and size, even with air bags. Even in vehicles equipped with the Passenger Sensing System, children are safer when properly secured in a rear seat in the appropriate infant, child or booster seat. Never place a rear-facing infant restraint in the front seat of any vehicle equipped with an active frontal air bag. See your vehicle Owner's Manual and child safety seat instructions for more safety information. ⁸When properly equipped; includes weight of vehicle, passengers, cargo and equipment.

VEHICLE SPECIFICATIONS

SIERRA HD SPECIFICATIONS

ENGINES

	VORTEC 6.0L V-8 VVT (L96)	DURAMAX DIESEL 6.6L V-8 TURBO (LML)
FUEL TYPE	Gasoline (FlexFuel)	Diesel (B20 biodiesel capable)
CAPACITY	6.0 liters (364 cu. in.)	6.6 liters (402 cu. in.)
SAE NET HORSEPOWER @ RPM	360@5400 (<10,000-lb GVWR) ¹ 322@4400 (>10,000-lb GVWR) ¹	397@3000
SAE NET TORQUE @ RPM (LB-FT)	380@4200	765@1600
TRANSMISSIONS	Electronically controlled 6-speed heavy-duty automatic transmission with overdrive, electronic engine grade braking and Tow/Haul mode	Electronically controlled Allison 1000 Series 6-speed automatic transmission with overdrive, electronic engine grade braking and Tow/Haul mode

STANDARD TECHNICAL DATA

	All models: Power 4-wheel antilock braking system	
Series / Drive Type	2WD	4WD
BRAKES	14" dia. 4-wheel disc	14" dia. 4-wheel disc
STEERING	Power recirculating ball	Power recirculating ball
FUEL TANK CAPACITY (Approx. gals.: Standard / Long Box)	36.0	36.0
ALTERNATOR (Amps)	125	125

MAXIMUM GVWR¹ (GROSS VEHICLE WEIGHT RATING) VORTEC 6.0L V-8/DURAMAX DIESEL 6.6L V-8 TURBO

	REGULAR CAB	CREW CAB
2500HD		
Standard Box	- / -	9500/10,000
Long Box	10,000/9900	9500/10,000
3500HD		
SRW	10,700/11,400	11,000/11,600
DRW	13,400/13,025	13,025/13,025

SELECT RATINGS All capacities in lbs	MAXIMUM PAYLOAD ³		MAXIMUM TRAILERING ⁴ BALL HITCH		MAXIMUM TRAILERING ⁴ FIFTH-WHEEL OR GOOSENECK	
	2WD / 4WD	2WD	4WD	2WD	4WD	
2500HD						
Regular Cab Long Box	4212/3538	13,000/13,000	13,000/13,000	14,700/17,800	14,400/17,500	
Crew Cab Standard Box	3347/3066	13,000/13,000	13,000/13,000	14,200/17,400	13,900/15,800	
Denali Crew Cab Standard Box	3347/3066	13,000/13,000	13,000/13,000	14,200/17,400	13,900/15,800	
Crew Cab Long Box	3247/3305	13,000/13,000	13,000/13,000	14,100/16,700	13,800/14,700	
3500HD						
Regular Cab SRW	4625/4609	13,000 / -	13,000/13,000	14,500 / -	14,200/17,400	
DRW	7222/6876	14,100 / -	13,800/16,000	14,200 / -	13,800/23,100	
Crew Cab SRW Standard Box	4187/4190	13,000/13,000	13,000/13,000	14,000/17,200	13,700/17,000	
SRW Long Box	4308/4266	13,000/13,000	13,000/13,000	13,900/17,300	13,600/16,800	
Denali SRW	4187/4190	13,000/13,000	13,000/13,000	14,000/17,200	13,700/17,000	
DRW	6245/5914	13,500/16,500	13,200/18,000	13,500/22,800	13,200/22,500	
Denali DRW	6245/5914	13,500/16,500	13,200/18,000	13,500/22,800	13,200/22,500	

FRONT SUSPENSIONS⁵ INDEPENDENT TORSION BAR-2500HD/3500HD

STANDARD FRONT AXLE CAPACITY	2WD	4WD
Regular Cab (lbs)	4400/4400	4400/4400
Crew Cab (lbs)	4400/4400	4800/4800
STANDARD FRONT SPRING CAPACITY		
Regular Cab (lbs)	4400/4400	4400/4400
Crew Cab (lbs)	4400/4400	4800/4800

REAR SUSPENSIONS⁵ SEMIELLIPTICAL MULTILEAF-2500HD/3500HD-SRW/3500HD-DRW

REAR AXLE CAPACITY	2WD
Regular Cab (lbs)	6200 / 7050 / 9825
Crew Cab (lbs)	6200 / 7050 / 9375
REAR SPRING CAPACITY	
Regular Cab (lbs)	6200 / 7050 / 9825
Crew Cab (lbs)	6200 / 7050 / 9375
REAR AXLE CAPACITY	4WD
Regular Cab (lbs)	6200 / 7050 / 9825
Crew Cab (lbs)	6200 / 7050 / 9375
REAR SPRING CAPACITY	
Regular Cab (lbs)	6200 / 7050 / 9375
Crew Cab (lbs)	6200 / 7050 / 9375

¹When properly equipped; includes weight of vehicle, passengers, cargo and equipment. ²Cargo and load capacity limited by weight and distribution. ³Maximum payload capacity includes weight of driver, passengers, optional equipment and cargo. ⁴Maximum trailer weight ratings are calculated assuming a base vehicle, except for any option(s) necessary to achieve the rating, plus driver. The weight of other optional equipment, passengers and cargo will reduce the maximum trailer weight your vehicle can tow. ⁵Capacities and weight ratings are dependent on model, engine, transmission and GVWR combinations. See your GMC dealer for details.

IMPORTANT WORDS

COMMITMENT PLUS

From the owner orientation—and full tank of gas—you receive when you take possession of your Sierra HD to the **24-Hour Roadside Assistance, Courtesy Transportation and Travel Benefits**, Commitment Plus is a portfolio of owner privileges that lasts throughout your warranty. For expert product information, Roadside Assistance or other services, call 1-800-GMC-8782.

TRAVEL BENEFITS AND ROADSIDE ASSISTANCE Available around the clock: trip routing service, a program for reimbursement for trip interruption due to necessary warranty repairs, towing, flat tire change, jump-starts and more for 5 years or 100,000 miles (whichever comes first).

COURTESY TRANSPORTATION Available at participating dealers: shuttle service, reimbursement of certain public transportation or fuel expenses for overnight warranty repairs and courtesy rental for overnight work repairs. See your dealer for details.

GMC OWNER CENTER A complimentary, one-stop resource to enhance your GMC ownership experience. It's easy to sign up. Just go to gm.com/gmownercenter/gmc.

ONSTAR



OnStar is a core asset of your Sierra HD. Benefiting from more than a decade of innovative development, it is both a highly advanced technology—fully integrated within the vehicle—and a warm human service. Standard on all Sierra HD models (except WT) are 6 months of the OnStar Directions & Connections Plan, including the convenience of available Hands-Free Calling.¹ It also includes Automatic Crash Response, Stolen Vehicle Assistance, link to Emergency Services, Roadside Assistance, Remote Door Unlock, OnStar Vehicle Diagnostics, Crisis Assist and Remote Horn and Lights. OnStar services require vehicle electrical system (including battery), wireless service and GPS satellite signals to be available and operating for features to function properly. OnStar acts as a link to existing emergency service providers. Not all vehicles may transmit all crash data. Visit onstar.com for coverage maps, details and system limitations. Services vary with conditions.

HANDS-FREE CALLING

Available OnStar Hands-Free Calling capability is built into your Sierra HD. It's there when your cell phone is unavailable, its battery is low, you can't reach it easily or you left it at home or in the office. Your Hands-Free Calling system is the right choice whenever you need an easy way to make and receive calls—at the touch of the phone icon on the rearview mirror or the steering-wheel-mounted controls. Voice-activated dialing is convenient because you don't have to dial when you are at the wheel. And Hands-Free Calling is reliable because it's specially designed for better reception and fewer dropped calls in areas of limited cellular reception.

ONSTAR TURN-BY-TURN NAVIGATION

Standard on all Sierra HD models (except WT) are 6 months of the OnStar Directions & Connections Plan that adds innovative, easy-to-use Turn-by-Turn Navigation plus Information and Convenience Services and Driving Directions. With Turn-by-Turn Navigation, you simply tell the OnStar Advisor your intended destination, and directions will automatically be sent to your Sierra HD. If you drive off course, the system can reroute you to your intended destination. An automated voice then guides you turn-by-turn until you arrive at your destination. Turn-by-Turn Navigation is further enhanced with eNAV, allowing you to send MapQuest™ directions directly to your vehicle. No need to print out directions; just call them up with simple voice commands.

SIRIUSXM SATELLITE RADIO



SiriusXM Satellite Radio² is standard on all Sierra HD models (except WT). It includes 3 trial months of service. SiriusXM Satellite Radio makes your drive come alive with commercial-free music channels from virtually every genre, artist-dedicated channels, live performances and more. Tune in to live play-by-play from the biggest sports, exclusive entertainment from top personalities, compelling talk, hilarious comedy, world-class news, local traffic and weather and family-friendly programming. Welcome to the world of satellite radio. Visit siriusxm.com for details.

GMC CERTIFIED SERVICE



Certified Service To help your Sierra HD live up to its performance promise, GMC Certified Service—found exclusively at your GMC dealer—is there. With all the engineering excellence in Sierra, GM-trained technicians have the expertise to care for all of it.

VISIT US AT GMC.COM



FACEBOOK.COM/GMC

ADDITIONAL NOTES

A NOTE ON CHILD SAFETY Always use safety belts and the correct child restraint for your child's age and size, even with air bags. Even in vehicles equipped with the Passenger Sensing System, children are safer when properly secured in a rear seat in the appropriate infant, child or booster seat. Never place a rear-facing infant restraint in the front seat of any vehicle equipped with an active frontal air bag. See your vehicle Owner's Manual and child safety seat instructions for more safety information.

TRAILERING AND OFF-ROAD INFORMATION Please carefully review the Owner's Manual for important safety information about trailering or off-road driving in your vehicle.

IMPORTANT WORDS ABOUT THIS CATALOG We have tried to make this catalog comprehensive and factual. We reserve the right, however, to make changes at any time, without notice, in prices, colors, materials, equipment, specifications, models and availability. Specifications, dimensions, measurements, ratings and other numbers in this catalog and other printed materials provided at the dealership or affixed to vehicles are approximates based upon design and engineering drawings and prototypes and laboratory tests. Your vehicle may differ due to variations in manufacture and equipment. Since some information may have been updated since the time of printing, please check with your GMC dealer for complete details. GMC reserves the right to lengthen or shorten the model year for any product for any reason, or to start and end model years at different times. All competitive claims are based on the latest information available at the time of printing and GM Large Pickup segment.

FLEET ORDERS Some standard content may be deleted with fleet orders. See dealer for details.

ENGINES GMC products are equipped with engines produced by GM Powertrain or other suppliers to GM worldwide. The engines in GMC products may also be used in other GM makes and models.

GMC.COM See more of Sierra HD on our Web site: gmc.com/sierra. More photos and information; hot links to related subjects; convenient dealer locator; pricing guide, spec out your own vehicle. Or call 1-800-GMC-8782.

AN IMPORTANT NOTE ABOUT ALTERATIONS AND WARRANTIES Installations or alterations to the original equipment vehicle (or chassis) as distributed by General Motors are not covered by the General Motors New-Vehicle Limited Warranty. The special body company, assembler, equipment installer or upfitter is solely responsible for warranties on the body or equipment and any alterations (or any effect of the alterations) to any of the parts, components, systems or assemblies installed by GM. General Motors is not responsible for the safety or quality of design features, materials or workmanship of any alterations by such suppliers.

NEW-VEHICLE LIMITED WARRANTY All GMC light-duty vehicles come with a fully transferable, no-deductible 5-year/100,000-mile (whichever comes first) Powertrain Limited Warranty. GM vehicles registered in the USA are also covered for 3 years or 36,000 miles (whichever comes first). Coverage includes tires and towing to your nearest GMC dealership. Repairs will be made to correct any vehicle defect and most warranty repairs will be made at no charge. In addition, rust-through corrosion will be covered for 6 years or 100,000 miles (whichever comes first). See dealer for details.

ASSEMBLY GMC vehicles and their components are assembled or produced by different operating units of General Motors, its subsidiaries or suppliers to GM worldwide. We sometimes find it necessary to produce GMC vehicles with different or differently sourced components than originally scheduled. Since some options may be unavailable when your vehicle is assembled, we suggest that you verify that your vehicle includes the equipment you ordered or, if there are changes, that they are acceptable to you.

GMMOBILITY.COM (1-800-323-9935) GM Mobility offers financial assistance for eligible adaptive equipment to make automotive travel easier for persons with disabilities or special transportation needs. To learn more about special GM Mobility offers, visit gmmobility.com.

GMCARDMEMBERSERVICES.COM Did you know about the family of reward credit cards that can help you get a great deal on a new GM car, light-duty truck, SUV or crossover? With a GM reward card, you accrue earnings on every credit card purchase to use toward the purchase or lease of an eligible new GM vehicle. With three cards to choose from, you're sure to find one that suits you.

¹Visit onstar.com for coverage map, details and system limitations. OnStar Hands-Free Calling requires existing OnStar service contract, prepaid minutes. Not available in certain markets. Calls can be made in U.S. and Canada only. ²If you subscribe after your trial period, *subscriptions are continuous until you call SiriusXM to cancel*. See SiriusXM Customer Agreement for complete terms at siriusxm.com. Other fees and taxes will apply. All fees and programming subject to change. For more information about NavTraffic, visit siriusxm.com/navtraffic. XM satellite service is available only to those in the 48 contiguous USA and DC.

©2013 General Motors. All rights reserved. GM, the GM logo, GMC, the slogans, emblems, vehicle model names, vehicle body designs and other marks appearing in this catalog are the trademarks and/or service marks of General Motors, its subsidiaries, affiliates or licensors. iPod and iPhone are registered trademarks of Apple, Inc. Facebook is a registered trademark of Facebook, Inc. Twitter is a registered trademark of Twitter, Inc. YouTube is a registered trademark of Google, Inc. Sirius, XM and all related marks and logos are trademarks of SiriusXM Radio, Inc.



TWITTER.COM/THISISGMC



YOUTUBE.COM/GMC

