

'56 PLYMOUTH SUBURBANS

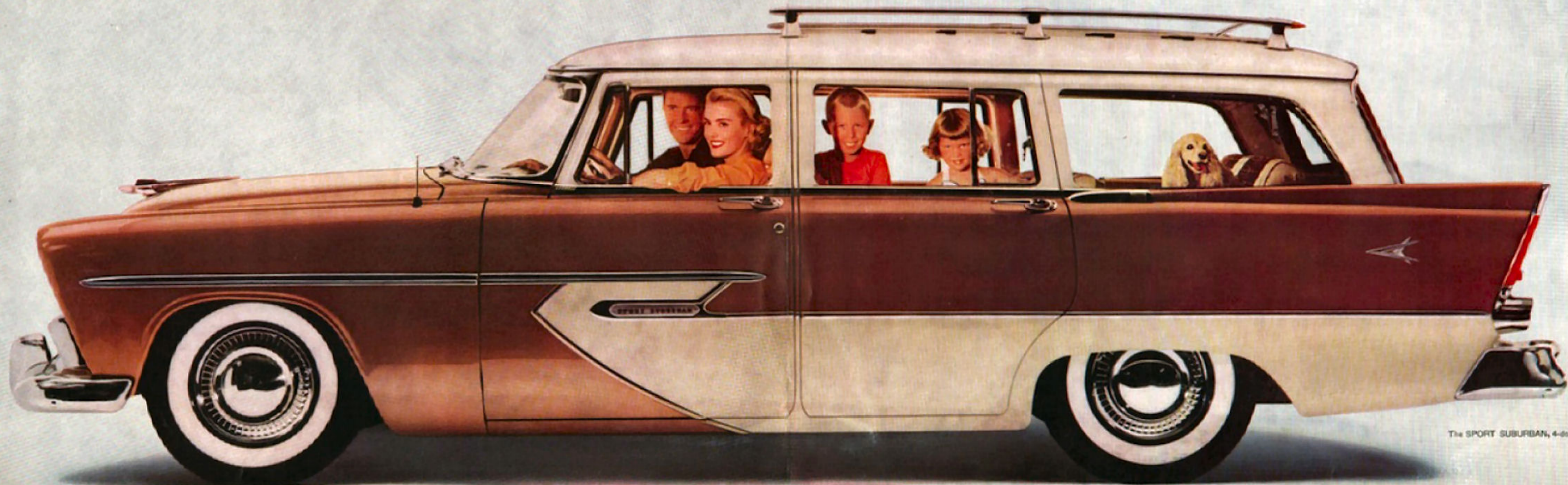

*The most luxurious Suburbans in Plymouth History . . . with exciting new **Aerodynamic Styling***

The safer car that's going places with the Young in Heart



The SPORT SUBURBAN, 4-door

4 Great Suburbans with big car comfort ... big car roominess

THE SPORT SUBURBAN, 4-DOOR

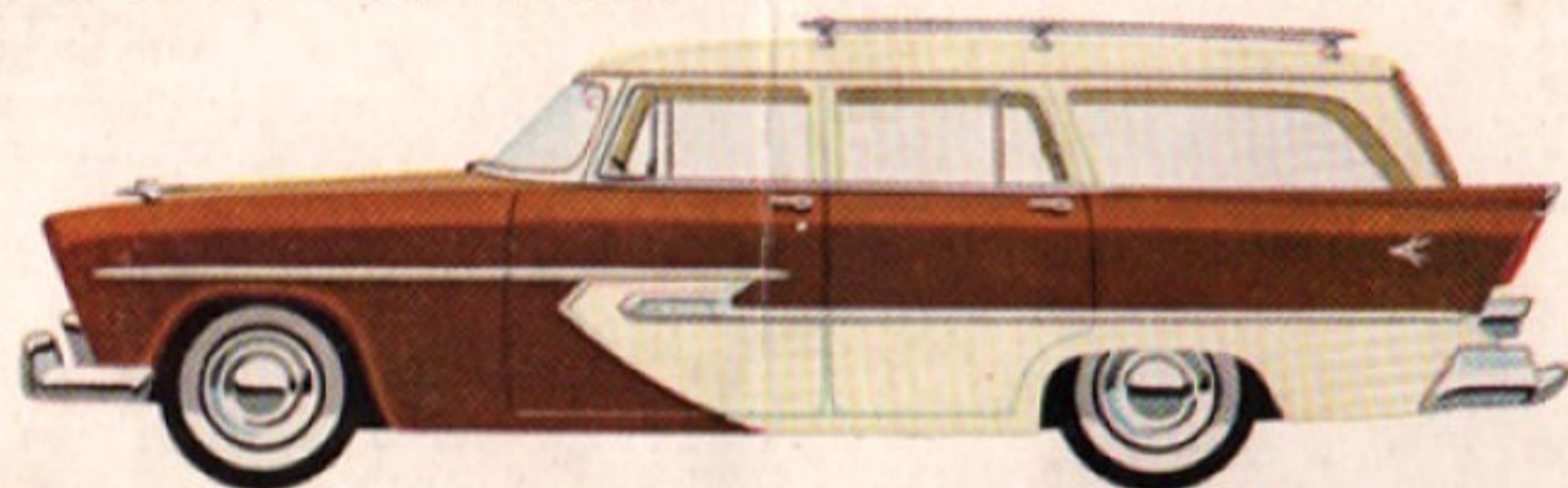

THE CUSTOM SUBURBAN, 4-DOOR

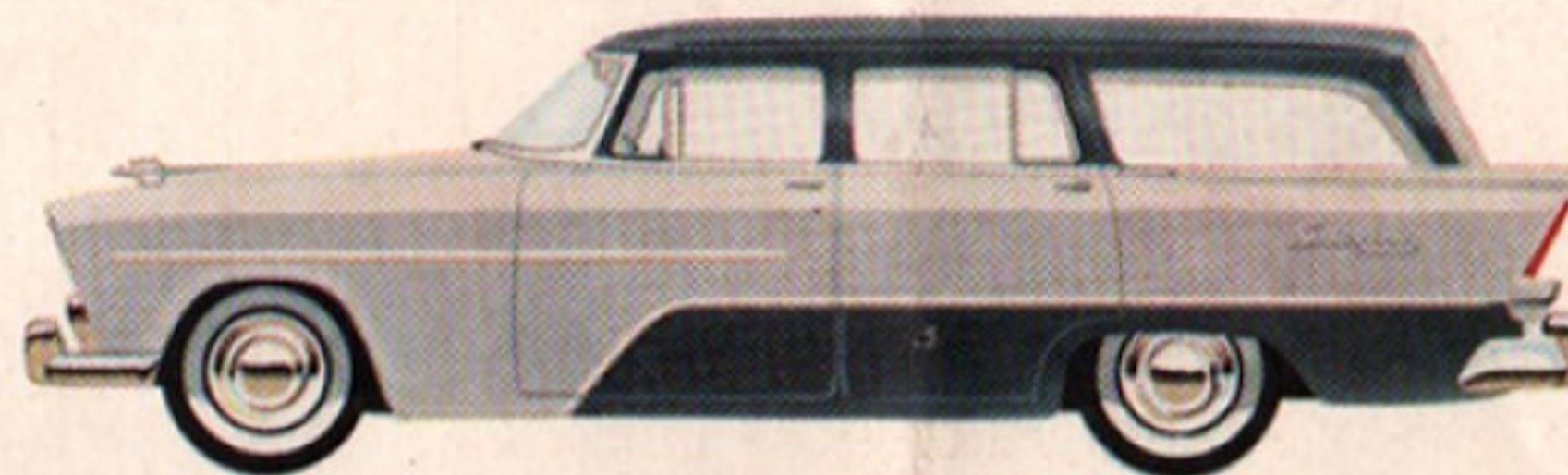

THE CUSTOM SUBURBAN, 2-DOOR

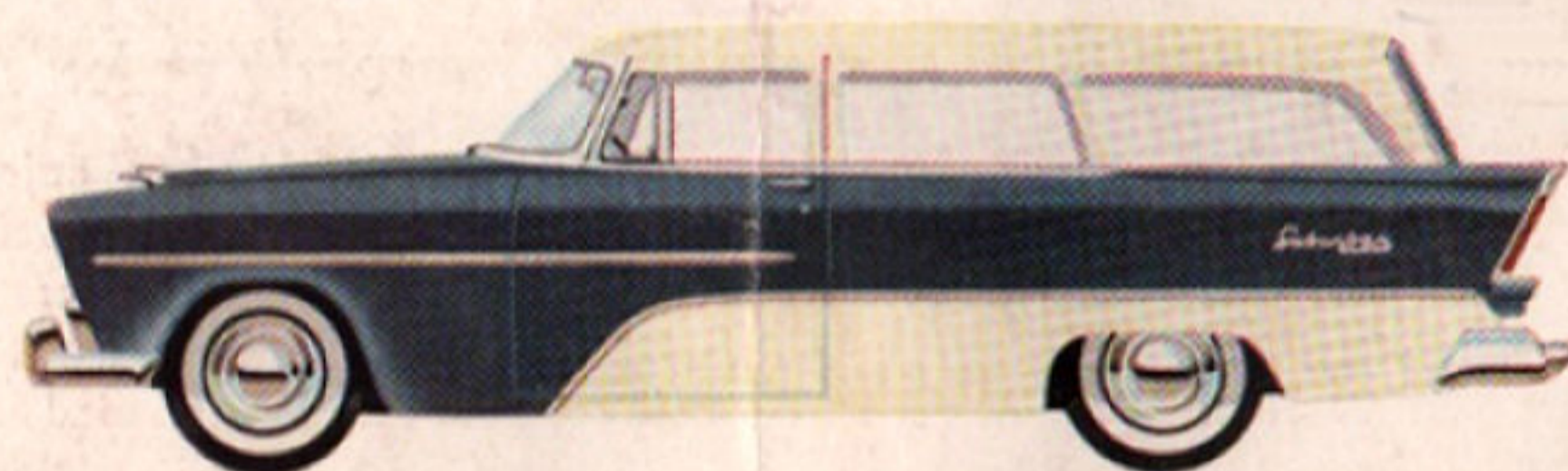

THE DE LUXE SUBURBAN, 2-DOOR



Cars are illustrated to show some items of special equipment such as trim, 2-tone paint, white wall tires, glamour bumper guards, and wheel covers — all available at moderate extra cost.

Dimensions shown apply to both 4-door and 2-door Suburbans

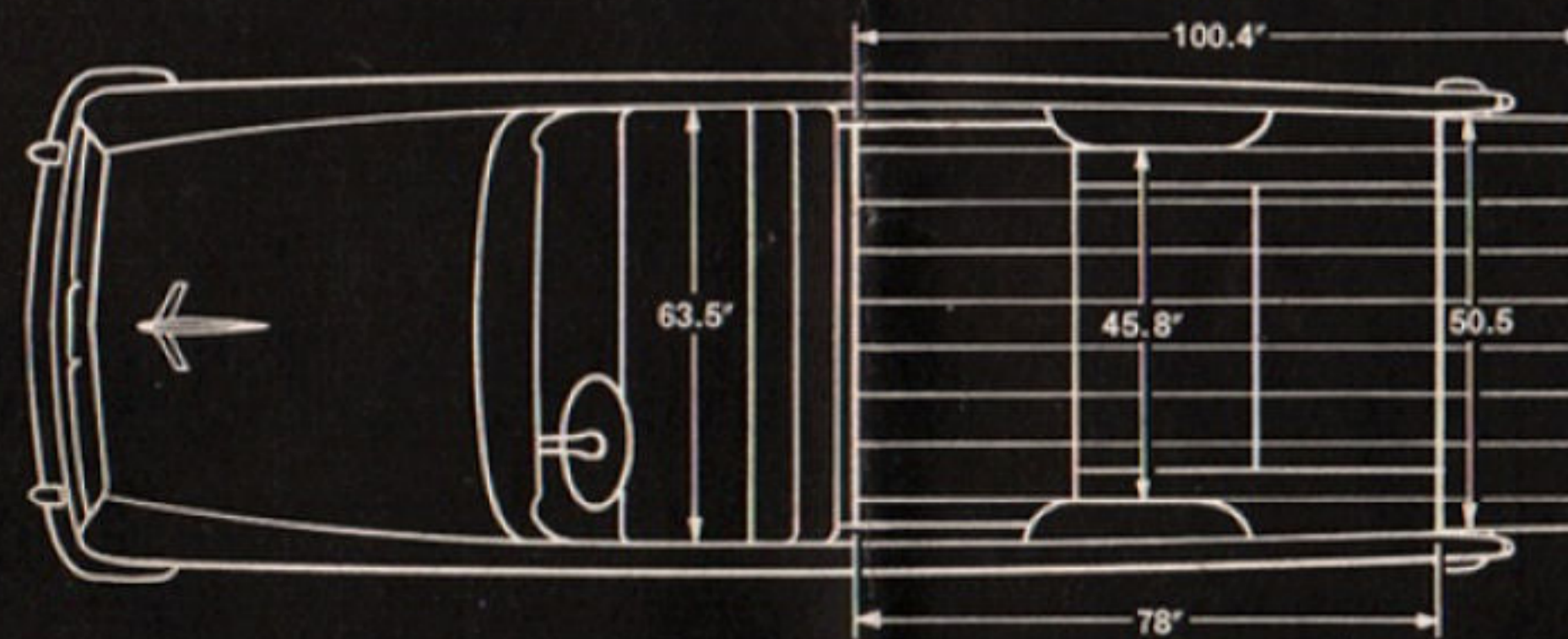
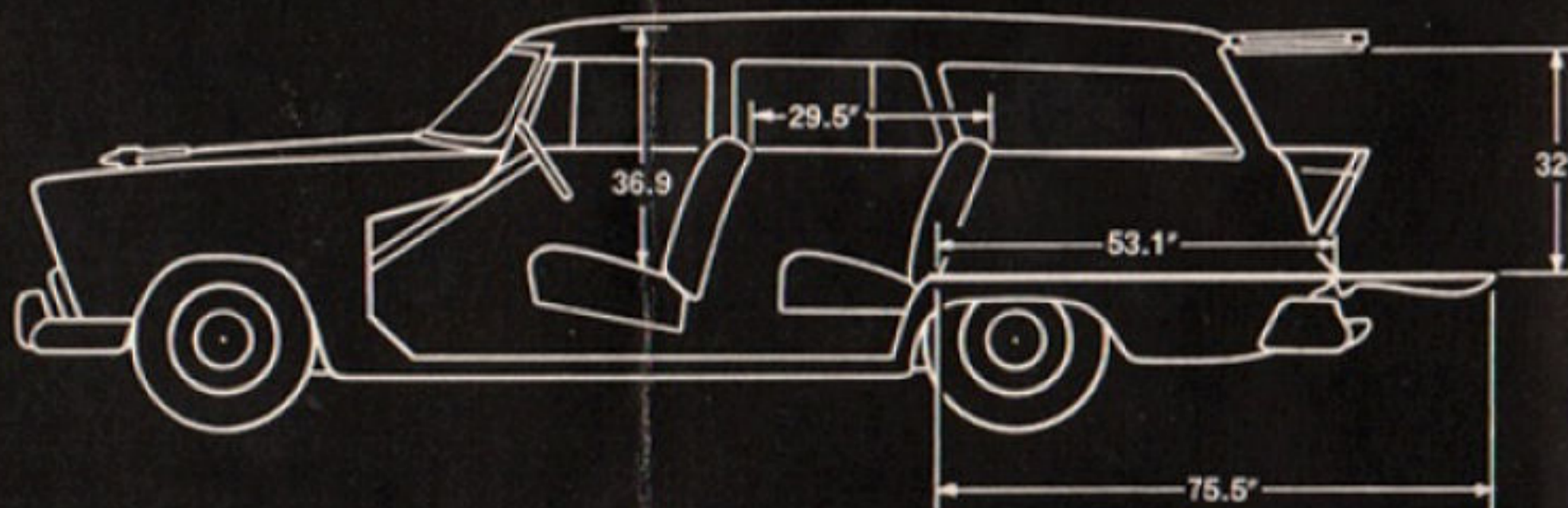

NEW HY-TORQUE POWER

gives you top thrust at take-off



Hy-Fire V-8

Here is the V-8 engine that gives you the most flashing performance ever built into a car in the lowest-price field. A touch of the accelerator, and you're away. For Plymouth puts high torque to work in all speed ranges . . . gives you *top thrust at take-off* . . . instant acceleration for quicker, *safer* passing on today's busy highways . . . and hill-climbing ability that lets you swoop up the steepest hill with the effortless ease of a jet plane in flight.

PowerFlow 6

New Plymouth increased-horsepower PowerFlow 6, with Chrome-Sealed Action, is the most dependable "6" on the road . . . proved by millions of miles of brilliant performance. This year the PowerFlow 6 is thriftier, too . . . and so rugged it rarely requires more than routine attention.

Specifications:

HY-FIRE V-8 MODELS

ENGINE TYPE: 8-cylinder V-8 with overhead valves. Counterbalanced crankshaft with 5 main bearings. Chain-driven camshaft. Adjustable valve tappets. **FUEL SYSTEM:** Dual-filtration includes Oilite fuel filter in gas tank and new, extra-fine ceramic filter at carburetor. **LUBRICATION:** Full pressure to all crankshaft, camshaft, and connecting rod bearings and to valve rocker arms and tappets. Rotor-type oil pump. Shunt-type micron oil filter (standard on Sport Suburban and Custom Suburban) with floating oil intake.

COOLING SYSTEM: Permanent by-pass temperature control. Full-length water jackets. Water pump with ball bearings. **STEERING:** Worm and roller type steering gear. Idler arm steering linkage for maximum controllability.

POWERFLOW 6 MODELS

ENGINE TYPE: 6-cylinder L-head valve arrangement. Counterbalanced crankshaft with 4 main bearings. Chain-driven camshaft. Aluminum alloy pistons. Top compression ring chrome-plated. Adjustable valve tappets with alloy steel exhaust valve seat inserts. **FUEL SYSTEM:** Oilite fuel filter in gas tank. **LUBRICATION:** Full pressure to all crankshaft, camshaft and connecting rod bearings. Rotor-type oil pump. Micronic oil filter (standard on Sport Suburban and Custom Suburban). Floating oil intake.

PUSH-BUTTON DRIVING

First with Plymouth in the lowest-price field



Push-Button PowerFlite

PowerFlite . . . the smoothest, simplest, safest automatic transmission of all, with push-button drive selection—right on the instrument panel, close to your left hand. Makes driving easy as flicking a light switch. You "shift" by a touch of a button. V-8 or "6" powered Plymouth Suburbans are available with a choice of drives: Push-Button PowerFlite, Overdrive, and Synchro-Silent (conventional).

Safety-Sure Power Brakes

STOP! Smoothly! Surely! Safely! With only half the pedal pressure you would normally use. And Plymouth's Power Brakes include all the superior important safety features of Plymouth's standard Safe-Guard Hydraulic Brakes.

COOLING SYSTEM: 6-blade fan. Permanent by-pass temperature control. Full-length water jackets. Water pump with Oilite bronze bearings. **STEERING:** Worm and roller type steering gear.

V-8 AND 6 MODELS

FUEL SYSTEM: Downdraft carburetor. Automatic choke. Heavy-duty oil bath air cleaner. **BODY SPECIFICATIONS:** Wheelbase 115 in. Over-all length 209 in. Over-all width 74.6 in. Tread 58.4 in. front; 58.5 in. rear. **CONSTRUCTION:** All-steel welded, completely rust-proofed and insulated body. Box-section reinforcements around window and door openings. Baked enamel finish. **VENTILATION:** Cow ventilator. Ventilating wings in each door. Full-width windshield defroster.

Full-Time Power Steering

Only Plymouth provides *full-time* coaxial power steering . . . does up to 80% of the work. In 100 miles of driving, it can save you as much energy as you would use shoveling a *ton of coal* . . . gives you a consistent "feel" of the road, unlike the conventional "on again, off again" part-time system you find in other cars. Women love it because it makes parking *so easy!*

Push-Button Power Seat

Plymouth's Power Seat is a great boon to comfort. You move backward and forward a full five inches (rising 1½ inches from rear to front). It works easily, completely automatically when you touch the push-button control.

Push-Button Power Windows

Here is convenience everyone can enjoy. Individual push-button window controls raise or lower each window automatically. The master panel, on the left front door, makes it easy for the driver to control all four of the windows.

PowerFlite, Overdrive, Power Steering, Power Brakes, Power Seats, Power Windows optional at moderate extra cost.

ELECTRICAL: 12-volt electrical system. High capacity 30 amp. generator with automatic voltage and current control. Lighting circuits protected with circuit breaker. **CHASSIS:** Steel frame with double-channel arc-welded box-type side rails. Four cross members.

FRONT SUSPENSION: Independent coil springs with Oriflow shock absorbers inside. Torsion-bar sway eliminator. **REAR SUSPENSION:** 2½ in.—wide rear springs, splay mounted for stability. Oriflow shock absorbers.

DRIVE: Hotchkiss drive with hypoid rear axle. **BRAKES:** Hydraulic brakes with individually anchored shoes. Two cylinders and two shoes in each front wheel. Cyclebonded linings. **TIRES AND WHEELS:** 6.70 x 15 tubeless tires. Safety-Rim wheels.

Specifications subject to change without notice.

your Plymouth dealer

*Look at all the ways you can use
the extra space a Suburban offers!*



1 Full room for 8 passengers in this three-seat, four-door Suburban station wagon. Rich interior fabrics in fashion-matched colors lend subtle emphasis to the brilliant exteriors.



2 No "squeezing" past the middle seat in the 3-seat Suburban. Split $\frac{3}{8}$ - $\frac{3}{8}$ seat offers easy access to the rear without disturbing other passengers . . . extra comfort for everyone.

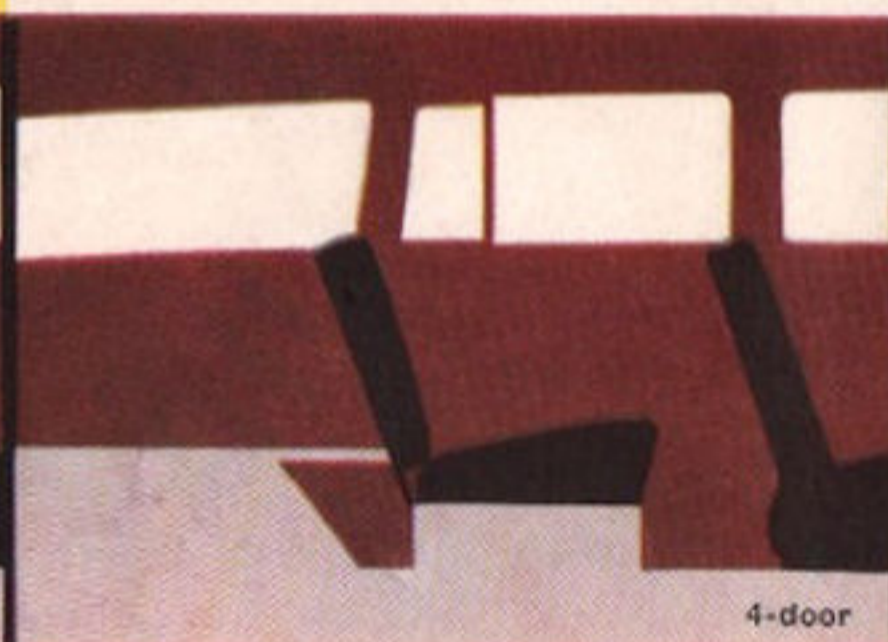

3 In the four-door Suburbans, rear seat can be removed. Provides easy-to-load luggage space that is ample for golf clubs, luggage and parcels . . . luxurious comfort for 6 passengers.

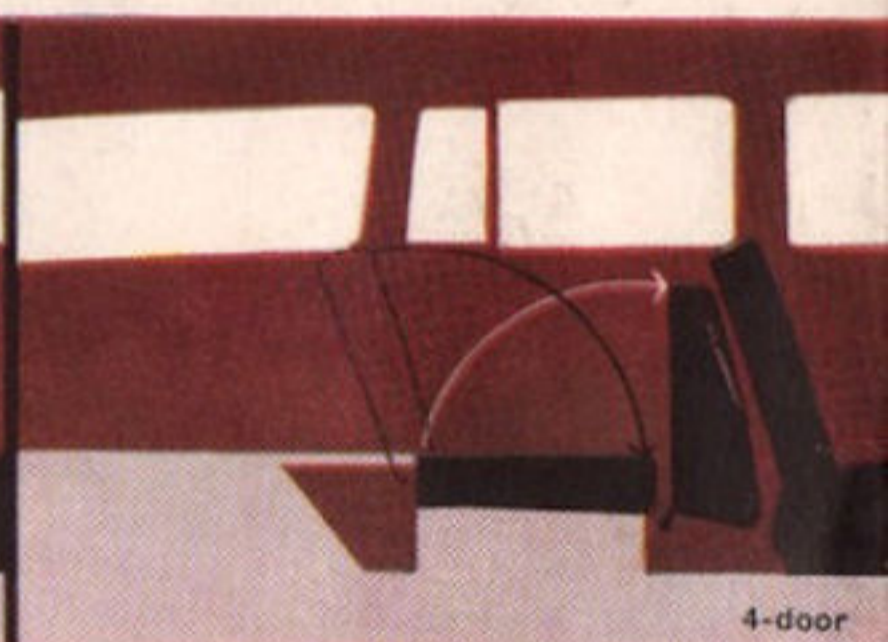

4 With third seat removed and second seat folded forward there is even more room for hunting and camping equipment, bulky garden tools, or luggage space for a cross-country trip.



1 Six-passenger, two-door Plymouth Suburban interiors offer lasting good looks, with glamorous new fabrics chosen for carefree service and long-lived durability. Lots of luggage space!

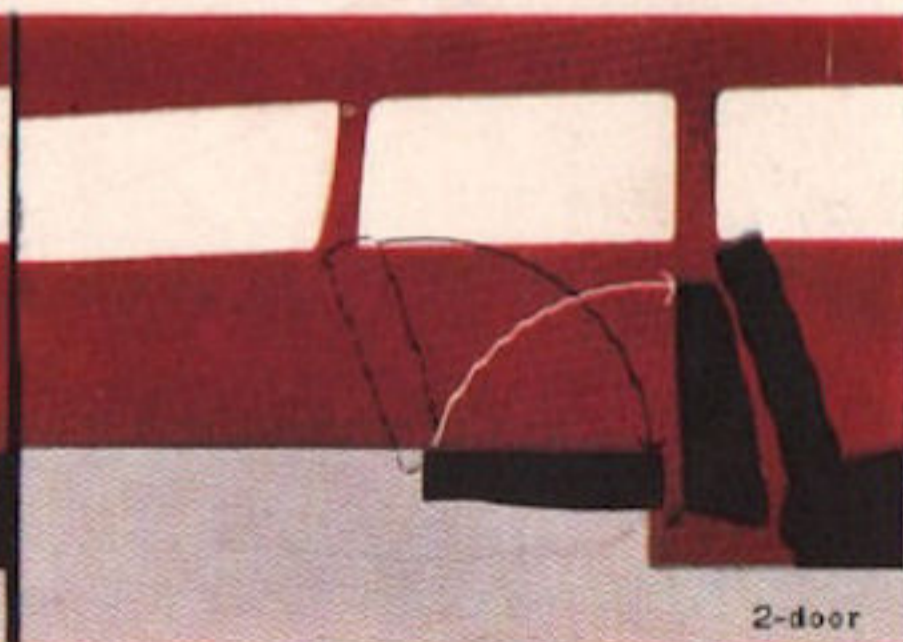

2 Rear seat may be folded forward to provide a huge platform 6 $\frac{1}{2}$ ft. long . . . making the Plymouth Suburban a smart all-purpose car for business, the sportsman or family use.

