

YOURS, AND YOURS ALONE

You can expect the same quality and design in our accessories that you find in every one of our vehicles. Whether your new Mitsubishi will join you in one action-packed road trip after another, or it will chauffeur you safely to and from your daily life, a variety of available accessories, options and custom add-ons allow you to personalize your Mirage G4 or Mirage to suit your lifestyle.

At Mitsubishi Motors, we believe not all drivers are created equal. So we build our vehicles for a different breed of driver, the fearless ones who take pride in what they drive, and refuse to drive more of the same. It's obvious to us that people who truly want distinctive styling and the latest technology see past the procession of bland imitations. We believe that every vehicle we make should stand for something. Something more than expected. And that's why we don't build Mitsubishi cars for stereotypes. We build them for you.

MITSUBISHICARS.COM 1-888-MITSU2019 NATLBRO-19-003



GENUINE ACCESSORIES

MIRAGE G4

SCUFF PLATES



ARMREST



EXHAUST FINISHER



MIRAGE

SHIFT KNOB



FOG LIGHTS



ALL-WEATHER FLOOR MATS



MIRAGE / MIRAGE G4



2019



PRIORITY: ADVENTURE

Never, ever settle for a car you don't love. Over the years you spend together, you'll ease yourself into the driver's seat to go to work, to run errands, to go on late-night burger runs, to go to concerts and the mountains and to help a friend move and a million other places. And every time, it should feel like an adventure. Every time you buckle up, you should feel that same thrill and break into that same silly grin you did the day you first drove it off the lot.

It's our goal to capture that spirit of excitement and newness in every Mitsubishi we dream up, design and deliver. That's the way we've approached it for more than 100 years. We've poured our passion for exploring technology and design into vehicles designed to take you to new places. Safely, reliably and with maximum excitement.

At Mitsubishi, our priority is creating adventures. For people whose priority it is to live them.

DRIVE YOUR AMBITION



DESIGN

FUN THAT GOES BEYOND LOOKS

Which will you choose? Practical yet fun? Or fun yet practical? The Mirage G4 and the Mirage were designed to be just the cars you're looking for. From the sharp, distinctive designs to the considerate features throughout, you'll be reminded of what a great choice you made each time you slide behind the wheel.

DESIGN MIRAGE G4

PRACTICAL DOESN'T MEAN BORING

The Mirage G4 gives you technology in all the right places. Features include standard steering wheel audio and Bluetooth® technology switches, ergonomically designed driver controls, a rear seat center armrest with two cup holders, a standard trunk pass-through and a driver seat armrest.¹ And the high-gloss black trim elements throughout the interior and the available 15 in. dark chrome alloy wheels add attractive touches.

ROOM FOR MORE THAN JUST FRIENDS

While it may be a subcompact car, the 2019 Mirage G4 has interior space for five adults. In fact, you and your friends will enjoy a full 101.8 cubic feet of interior space. And if the five of you are hitting the road in search of your next epic experience, you'll find plenty of room in the trunk for your luggage.

GO AHEAD, STRETCH YOUR LEGS

The Mirage G4 doesn't merely accommodate five adults. It does so with class-leading total legroom and class-leading rear seat legroom.² Feel free to invite along friends over 5 feet tall.

CLASS-LEADING CURB WEIGHT

Weighing in at a svelte 2,172 lbs., the Mirage G4 ES CVT is hundreds of pounds lighter than all other vehicles in its class.² That significant weight advantage is one reason it also leads the class in fuel efficiency.³



Mirage G4 SE in Infra Red



Mirage GT in Pearl White

DESIGN MIRAGE

ALWAYS UP FOR A GOOD TIME

Inside and out, the 2019 Mirage offers bold and energetic styling. Its distinct front-end design and LED taillights make a sharp impression from any angle. But it's not all about appearances. Inside, there's up to 47.0 cubic feet of cargo space. Plenty of room to accommodate your friends and all your stuff. And with eight expressive exterior colors to choose from, Mirage is all about a good time.

STANDARD LED TAILLIGHTS

Mirage's standard equipment LED taillights not only look sleek and sharp, they also light up faster, are more visible both day and night, and last longer than their conventional counterparts. They make the Mirage a great car to be seen in.

AVAILABLE HID HEADLIGHTS

Mirage's available High-Intensity Discharge headlights produce more illumination per unit of electrical power than conventional lamps because a greater proportion of their output is in the visible light spectrum, rather than the infrared light spectrum. Brighter lights make for a safer trip.

60/40-SPLIT FOLDING REAR SEAT

Mirage's folding rear seat helps you take full advantage of its interior space, allowing you to carry large or oddly shaped items in the back. Items like, say, a mountain bike or a Great Dane.

AVAILABLE ALLOY WHEELS

Sweet wheels get noticed. So Mirage offers available distinctive 14 and 15 in. alloy wheels. With their taller profile, the 15 in. wheels sport a shorter tire sidewall, which can help minimize side-to-side flex when turning corners. And sporting a sharp two-tone finish, they also excel at turning heads.

TECHNOLOGY

ADVANCED FUN

We didn't just create safe, fuel-efficient and fun-to-drive cars, then stop there. Oh no. We loaded them up with some of the latest technology. Not many things are more fun than hearing your passengers say, "Your car can do what?"





TECHNOLOGY

MIRAGE G4 / MIRAGE

SMARTPHONE LINK DISPLAY AUDIO SYSTEM

Our available Smartphone Link Display Audio system allows you to maintain caution behind the wheel, while still using your smartphone for communication and navigation. This advanced feature supports Apple CarPlay™ and lets you access Apple Music®, Maps, make phone calls and send messages. All through the touchscreen, or with your voice using Siri®.⁴ The system also supports Android Auto™. Simply press the Push To Talk button to connect to Google, and access all the most commonly used features on the Android™ platform, such as Google Play™ Music, Google Maps™, and Hangouts™.⁵

USB CONNECTIVITY

The right driving soundtrack when you hit the highway is a must. A standard USB port located in the center console lets you plug in your smartphone, iPod® or other compatible MP3 device. Your personal library of road trip tunes is at your fingertips.⁶

AUTOMATIC CLIMATE CONTROL

This available feature helps keep the cabin comfy by automatically controlling the temperature and fan speed, as well as the air source. Desert or mountains, you'll be comfortable.

FAST-KEY ENTRY SYSTEM

An available FAST-Key (Freehand Advanced Security Transmitter) entry system lets you unlock the driver's door while the keys remain in your pocket or purse.

PUSH BUTTON START

Operating in conjunction with the available FAST-Key entry system, this convenient feature allows you to start the engine with the keys tucked safely in your pocket or purse.

CRUISE CONTROL

Take long weekend drives and road trips seriously with convenient and easy-to-use cruise control, now standard on all trims for both Mirage G4 and Mirage. Simply press the cruise control button when at your desired speed and it will moderate the throttle for you.

BLUETOOTH® TECHNOLOGY

To help you concentrate on the road ahead, standard Bluetooth® wireless technology allows you to play music from your Bluetooth-enabled phone, iPod®, or other MP3 player devices.¹⁶

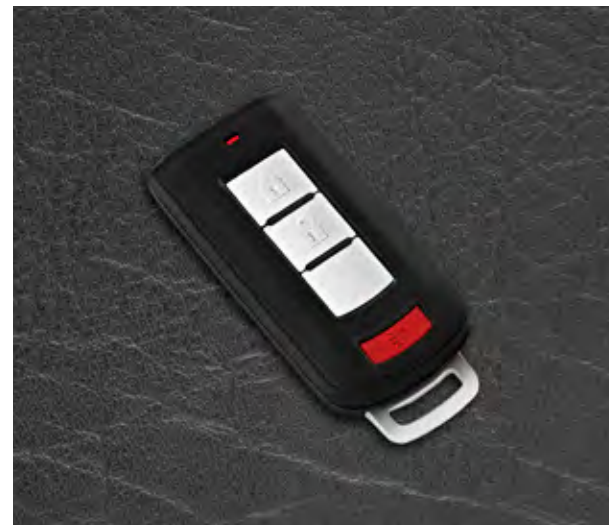



ECOLOGY

THE WORLD YOU SAVE MAY BE YOUR OWN

It's a wide world out there. Let's be good to it. Driving cars with the best fuel economy ratings in their classes, as well as the best CO₂ emissions ratings, is a nice way to go.^{3,2}





ECOLOGY

MIRAGE G4 / MIRAGE

CONTINUOUSLY VARIABLE TRANSMISSION

Offering both improved performance and enhanced fuel economy (both are things we thought you would like), our Continuously Variable Transmission (CVT) is one of the smoothest drivetrains ever developed. It operates on an advanced pulley system, allowing infinite variability between the highest and lowest ratios. Instead of shifting gears, it adapts to changing vehicle speeds and helps keep the engine operating efficiently. Mountain roads are no match for it.

1.2-LITER ENGINE

A 1.2-liter, 3-cylinder DOHC engine delivers a balanced 78 horsepower and 74 lb.-ft. of torque. Matched to either an easy-shifting 5-speed manual transmission or our available CVT, this compact power plant provides smooth power with outstanding efficiency. In fact, the Mirage G4 and the Mirage are the two most fuel-efficient non-hybrid cars in America, with combined mileage ratings of 37 and 39 mpg, respectively. Their CO₂ emissions ratings lead their classes, as well.^{3,2}

MITSUBISHI INNOVATIVE VALVE TIMING ELECTRONIC CONTROL

The latest generation of Mitsubishi Innovative Valve timing Electronic Control (MIVEC) is an advanced variable valve timing system that helps maximize fuel efficiency, while minimizing smog-forming exhaust emissions. Go ahead, get out into that fresh air, knowing you're helping to keep it that way.

TIRE PRESSURE MONITORING SYSTEM

Maintaining proper tire pressure is not only important for safe driving, it also helps your vehicle achieve its best fuel efficiency. The Tire Pressure Monitoring System (TPMS) evaluates the pressure of each tire and warns you if the level becomes critically low.

FROM POINT A TO B IN A BREEZE

With the help of computer-aided design software, our designers are able to optimize aerodynamic shapes that cut easily through the atmosphere. In fact, Mirage achieved a 0.28 drag coefficient at our wind tunnel test facility. That means you'll slip easily along, from one adventure to the next.

ELECTRIC POWER STEERING

Electric power steering not only ensures predictable steering, but also improves your gas mileage. Without the burden of a belt-driven hydraulic pump (as in traditional, non-electric power steering), the engine runs more efficiently.

STANDARD REAR SPOILER

Absolutely, Mirage's standard rear spoiler looks great, but it also enhances aerodynamic performance by reducing air turbulence behind the vehicle.

INFO AT A GLANCE

To help provide you with driving data at a glance, which can help you drive more efficiently, the Mirage G4 and Mirage both offer an available semi-high contrast meter cluster with chrome accents.





SAFETY

TRAVEL SAFE, TRAVEL SOUND

Call us overprotective. We think driving should be fun, and the safer you, your passengers and everyone you share the road with are, the better your trip will be.

SAFETY

MIRAGE G4 / MIRAGE

REINFORCED IMPACT SAFETY EVOLUTION BODY

Engineered for maximum protection in the event of a collision, our vehicle bodies employ Reinforced Impact Safety Evolution (RISE) engineering and combine energy-absorbing front and rear structures with a super-rigid occupant cell, along with reinforcing bars in the doors and energy-absorbing materials in the side pillars. Mirage G4 and Mirage are small, but tough.

STANDARD REARVIEW CAMERA

The standard rearview camera helps you view the area directly behind your vehicle on the audio display screen, for improved safety.

ACTIVE STABILITY CONTROL WITH TRACTION CONTROL

Active Stability Control (ASC) with Traction Control Logic (TCL) helps you maintain control in adverse driving conditions and during emergency maneuvers. Sensors monitor traction and activate the anti-lock braking system when it detects skidding or a loss of traction. By applying the brakes on specific wheels, the system helps your car track in your intended direction.

SEVEN STANDARD AIRBAGS

The Mirage G4 and Mirage both feature a standard Supplemental Restraint System (SRS) that consists of seven airbags, including dual-stage front airbags with a seat position sensor, front side-impact airbags, 1st- and 2nd-row side-impact curtain airbags, and a driver's knee airbag*. You can't be too careful.

HILL START ASSIST

When accelerating from a standstill on a steep incline, Hill Start Assist helps prevent your Mirage G4 or Mirage from rolling backward. When activated, this standard feature holds the brakes for approximately two seconds, which gives you time to move your foot from the brake pedal to the accelerator.

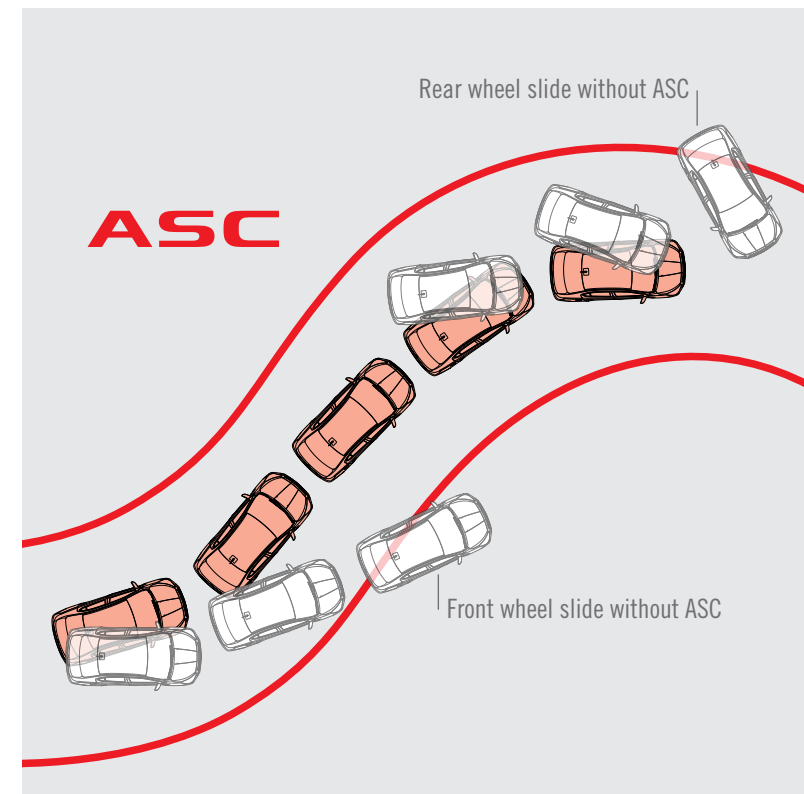

Mirage GT in Sapphire Blue



WARRANTY







10-YEAR/100,000-MILE WARRANTY

Your new Mitsubishi Mirage G4 or Mitsubishi Mirage is backed by a 10-year/100,000-mile Powertrain Limited Warranty, a 5-year/60,000-mile fully transferable New Vehicle Limited Warranty, a 7-year/100,000-mile Anti-Corrosion/Perforation Limited Warranty and 5-year/Unlimited Miles Roadside Assistance. They're some of the most comprehensive warranties in the industry. We want your relationship with your new Mirage G4 or Mirage to be a long and happy one.

10-year
100,000-mile
POWERTRAIN LIMITED WARRANTY



SPECIFICATIONS MIRAGE G4

| EXTERIOR COLORS | ES | SE | EXTERIOR COLORS | ES | SE |
|---|-----|-----|--|-----|-----|
| Pearl White  | 1,2 | 3,4 | Wine Red  | 1,2 | 3,4 |
| Starlight Silver  | 1,2 | 3,4 | Infra Red  | 1,2 | 3,4 |
| Mercury Gray  | 1,2 | 3,4 | Sapphire Blue  | 1,2 | 3,4 |
| Mystic Black  | 1,2 | 3,4 | | | |

The numbers indicate interior colors / trims available with exterior vehicle color.

INTERIOR COLORS



1) ES Light Gray Fabric

2) ES Black Fabric

3) SE Light Gray Fabric

4) SE Black Fabric

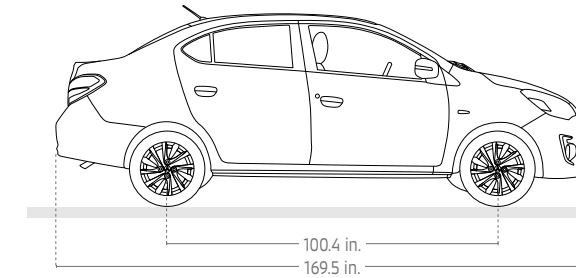

EXTERIOR DIMENSIONS

| | |
|----------------|-----------|
| Overall length | 169.5 in. |
| Wheelbase | 100.4 in. |
| Track, Front | 56.9 in. |
| Track, Rear | 56.3 in. |

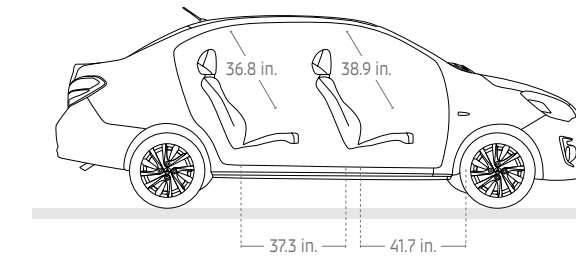

INTERIOR DIMENSIONS (SAE)

| | Head Room | Shoulder Room | Legroom | Hip Room |
|-------|-----------|---------------|----------|----------|
| Front | 38.9 in. | 51.7 in. | 41.7 in. | 46.7 in. |
| Rear | 36.8 in. | 51.2 in. | 37.3 in. | 48.2 in. |

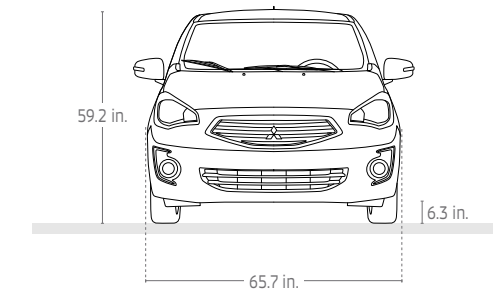

EXTERIOR DIMENSIONS

| | |
|------------------|----------|
| Overall height | 59.2 in. |
| Overall width | 65.7 in. |
| Ground clearance | 6.3 in. |

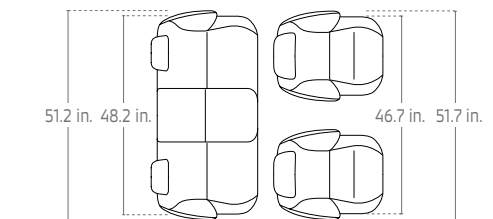

VOLUME (SAE)

| | |
|------------------|-----------------|
| Interior volume | 101.8 cubic ft. |
| Passenger volume | 89.2 cubic ft. |
| Cargo volume | 12.6 cubic ft. |

Illustrations are for design purposes only.

SPECIFICATIONS MIRAGE G4









| ENGINE / TRANSMISSION | ES / SE |
|--|---|
| Type | 1.2L MIVEC DOHC, 12-valve inline 3-cylinder |
| Materials | Aluminum head/block |
| Bore x stroke | 75.0 mm x 90.0 mm |
| Compression ratio | 10.5:1 |
| Displacement | 1193cc |
| Horsepower | 78 @ 6000 rpm |
| Torque | 74 lb-ft @ 4000 rpm |
| 5-speed manual transmission | STD / - |
| Continuously Variable Transmission (CVT) | OPT / STD |
| SUSPENSION | |
| Front | MacPherson strut with stabilizer bar |
| Rear | Torsion beam |
| STEERING | |
| Type | Rack-and-pinion, Electric Power Assist |
| Turn circle - curb to curb | 31.5 ft. |
| BRAKES / TIRES / WHEELS | |
| Front | Ventilated disc |
| Rear | Drum brake |
| Anti-lock Braking System (ABS) | STD |
| Wheels | 14 in. steel wheels with wheel covers (ES) 15 in. dark chrome alloy wheels (PKG ES) / (SE) |
| Tires | 165/65R14 (ES) / 175/55R15 (PKG ES) / (SE) |
| CAPACITIES | |
| Passenger seating | 5 |
| Fuel Capacity | 9.2 gallons |
| WEIGHTS | |
| GVWR CVT (SMT) | 3,108 lbs. (3,053 lbs.) / 3,108 lbs. |
| Curb weight CVT (SMT) | 2,172 lbs. (2,106 lbs.) / 2,194 lbs. |
| FUEL ECONOMY | |
| CVT City / Highway / Combined (mpg) ³ | 35/41/37 |
| SMT City / Highway / Combined (mpg) ³ | 33/40/35 |

| EXTERIOR FEATURES | ES | SE |
|---|-----|-----|
| Halogen headlights | STD | STD |
| Fog lights | ACC | STD |
| Rear combination taillights | STD | STD |
| High mount rear stop light | STD | STD |
| Lower side air dam | STD | STD |
| Color-keyed front and rear bumpers | STD | STD |
| Color-keyed folding side-view mirrors | STD | - |
| Color-keyed folding side-view mirrors with turn indicators | - | STD |
| Color-keyed outside door handles | STD | STD |
| Dark chrome grille accents | STD | STD |
| Front windshield variable intermittent wipers | STD | STD |
| Power side-view mirrors | STD | STD |
| Rear window defroster with timer | STD | STD |
| Laminated windshield | STD | STD |
| 14 in. steel wheels with wheel covers | STD | - |
| 15 in. dark chrome alloy wheels | PKG | STD |
| Temporary spare tire | STD | STD |
| Door sash black out | STD | STD |
| Short pole antenna | STD | STD |
| SE badge | - | STD |
| INTERIOR FEATURES | | |
| Speedometer / tachometer gauge cluster | STD | STD |
| Semi-high contrast meter with chrome accent | - | STD |
| Front room light | STD | STD |
| Cargo light | STD | STD |
| 6-way adjustable driver's seat | - | STD |
| 4-way adjustable front passenger seat | STD | STD |
| Driver's seat armrest | - | STD |
| Heated front seats | - | STD |
| Rear seat pass through | STD | STD |
| Rear seat center armrest with cup holders (x2) | STD | STD |
| Rear seat head restraints (x2) | STD | STD |
| Leather-wrapped steering wheel | - | STD |
| Urethane steering wheel | STD | - |
| Tilt steering wheel | STD | STD |
| Leather-wrapped shift knob | - | STD |
| Silver shift panel (CVT only) | STD | - |
| Gloss black shift panel | - | STD |
| Gloss black center panel | STD | STD |
| Gloss black power window switch panel accents | - | STD |
| Material-color inner door handles | STD | - |
| Chrome-plated inner door handles | - | STD |
| Chrome accented HVAC panel | STD | STD |
| Driver and passenger sun visors with driver's side vanity mirror, lid and ticket holder | STD | STD |
| Remote hood and fuel door release lever | STD | STD |

| CONVENIENCE FEATURES | ES | SE |
|--|-----|-----|
| 6.5 in. Smartphone Link Display Audio (SDA) System, Apple CarPlay™ and Android Auto™ compatibility and 4 speakers ^{4,5} | PKG | STD |
| Touch-panel display audio system with 4 speakers | STD | - |
| Bluetooth® wireless technology with steering wheel mounted controls ¹ | STD | STD |
| USB port | STD | STD |
| Rearview camera | STD | STD |
| Steering wheel-mounted cruise control | STD | STD |
| Steering wheel-mounted audio controls | STD | STD |
| Steering wheel-mounted voice controls | PKG | STD |
| FAST-Key passive entry system with push button start and panic feature | - | STD |
| Remote keyless entry with panic feature | STD | - |
| Air conditioning | STD | STD |
| Automatic climate control | - | STD |
| Micron air filtration | STD | STD |
| Rear heater floor ducts | STD | STD |
| Power windows | STD | STD |
| Power door locks | STD | STD |
| 12-volt accessory outlet (x1) | STD | STD |
| Floor console with cup holders | STD | STD |
| Front door panel storage pockets | STD | STD |
| Retractable assist grips (front x2) | STD | STD |
| Glove box | STD | STD |
| ECO indicator light | STD | STD |
| SAFETY AND SECURITY | | |
| Hill Start Assist (HSA) | STD | STD |
| Anti-lock Braking System (ABS) with Electronic Brakeforce Distribution (EBD) and Brake Assist (BA) | STD | STD |
| Active Stability Control (ASC) | STD | STD |
| Tire Pressure Monitoring System (TPMS) | STD | STD |
| Advanced dual-stage SRS front airbags ⁷ | STD | STD |
| Side curtain airbags ⁷ | STD | STD |
| Driver's knee airbag ⁷ | STD | STD |
| Three-point seat belts for all seating positions | STD | STD |
| Adjustable front shoulder belts with pretensioner | STD | STD |
| LATCH child-restraint system | STD | STD |
| Child safety rear door locks | STD | STD |
| Anti-theft engine immobilizer | STD | STD |
| RISE body construction | STD | STD |

| ADDITIONAL FACTORY PACKAGES | ACCESSORIES |
|---|--|
| Smartphone Display Package available on ES | Remote Engine Start (CVT only) Available on SE |
| · 6.5 in. Smartphone Link Display Audio (SDA) System, Apple CarPlay™ and Android Auto™ ^{4,5} compatibility | Wheel Locks Available on both trims |
| · 15 in. dark chrome alloy wheels | LED DRLs with Garnish Available on both trims |
| · AM/FM/CD/MP3 audio system | Fog Lights Available on ES |
| · Steering wheel voice controls | All-Weather Floor Mats (4) Available on both trims |
| Exterior Package | Exhaust Finisher Available on both trims |
| · Front, rear and side air dams | Side Sill Extensions Available on both trims |
| Interior Package | Armrest Console Available on ES |
| · Gloss black accent panels | Carpeted Floor Mats and Portfolio Available on both trims |
| · Leather/aluminum shift knob | Rear Lip Spoiler Available on both trims |
| All-Weather Package | Rear Park Assist Sensors Available on both trims |
| · All-weather floor mats (4) | |
| · Cargo tray | |
| Chrome Package | |
| · Meter cluster chrome accent | |
| · Exhaust finisher | |
| Protection Package | |
| · Scuff plates | |
| Cargo Package | |
| · Cargo mat | |
| · Cargo net | |
| LED Illumination Package | |
| · Floor illumination (blue) | |
| · Center console illumination (blue) | |
| · Room lamp | |
| Rockford Fosgate Package | |
| · Rockford Fosgate 300-watt ecoPUNCH amplifier and subwoofers | |
| Popular Equipment Value Package | |
| · Exhaust finisher | |
| · Scuff plates | |
| · Cargo tray | |
| ES Popular Equipment Value Package | |
| · Armrest console | |
| · Cargo mat | |
| · Cargo net | |

SPECIFICATIONS MIRAGE

| EXTERIOR COLORS | ES | LE | SE | GT | EXTERIOR COLORS | ES | LE | SE | GT |
|---|----|----|----|----|--|----|----|----|----|
| Pearl White  | 1 | 2 | 1 | 1 | Wine Red  | 1 | 2 | 1 | 1 |
| Starlight Silver  | 1 | 2 | 1 | 1 | Sunrise Orange  | 1 | 2 | 1 | 1 |
| Mercury Gray  | 1 | 2 | 1 | 1 | Infra Red  | 1 | 2 | 1 | 1 |
| Mystic Black  | 1 | 2 | 1 | 1 | Sapphire Blue  | 1 | 2 | 1 | 1 |

The numbers indicate interior colors / trims available with exterior vehicle color.

INTERIOR COLORS



1) Black Fabric

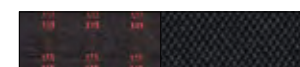

2) Black Fabric with Red Accent Surfaces

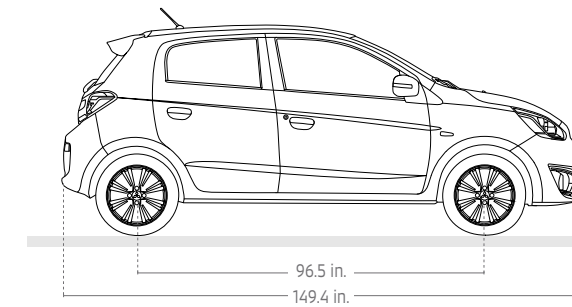

EXTERIOR DIMENSIONS

| | |
|----------------|-----------|
| Overall length | 149.4 in. |
| Wheelbase | 96.5 in. |
| Track, Front | 56.3 in. |
| Track, Rear | 55.7 in. |

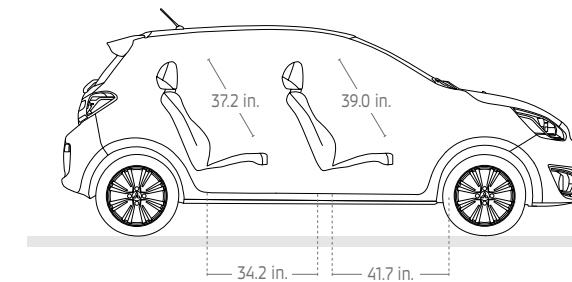

INTERIOR DIMENSIONS (SAE)

| | Head Room | Shoulder Room | Legroom | Hip Room |
|-------|-----------|---------------|----------|----------|
| Front | 39.0 in. | 51.7 in. | 41.7 in. | 48.8 in. |
| Rear | 37.2 in. | 51.0 in. | 34.2 in. | 46.4 in. |

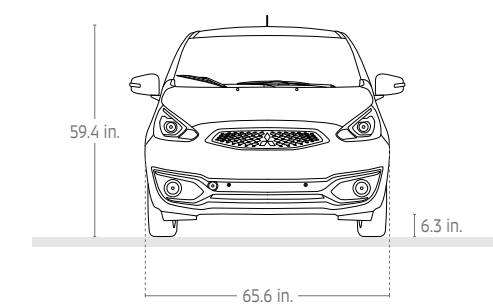

EXTERIOR DIMENSIONS

| | |
|------------------|----------|
| Overall height | 59.4 in. |
| Overall width | 65.6 in. |
| Ground clearance | 6.3 in. |

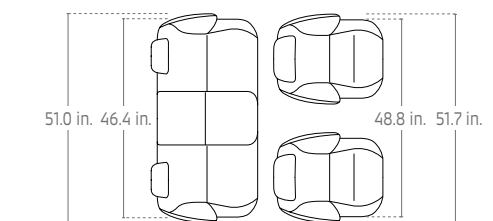

VOLUME (SAE)

| | |
|--------------------------------|-----------------|
| Interior volume | 103.3 cubic ft. |
| Passenger volume | 86.2 cubic ft. |
| Cargo volume (rear seats up) | 17.1 cubic ft. |
| Cargo volume (rear seats down) | 47.0 cubic ft. |

Illustrations are for design purposes only.

SPECIFICATIONS MIRAGE

| ENGINE / TRANSMISSION | ES / LE / SE / GT |
|--|--|
| Type | 1.2L MIVEC DOHC, 12-valve inline 3-cylinder |
| Materials | Aluminum head/block |
| Bore x stroke | 75.0 mm x 90.0 mm |
| Compression ratio | 10.5:1 |
| Displacement | 1193 cc |
| Horsepower | 78 @ 6000 rpm |
| Torque | 74 lb-ft @ 4000 rpm |
| 5-speed manual transmission | STD / - / - |
| Continuously Variable Transmission (CVT) | OPT / STD / STD |
| SUSPENSION | |
| Front | MacPherson strut with stabilizer bar |
| Rear | Torsion beam |
| STEERING | |
| Type | Rack-and-pinion, Electric Power Assist |
| Turn circle - curb to curb | 30.2 ft |
| BRAKES / TIRES / WHEELS | |
| Front | Ventilated disc |
| Rear | Drum brake |
| Anti-lock Braking System (ABS) | STD |
| Wheels | 14 in. steel wheels with wheel covers (ES) / 14 in. alloy wheels (SE) / 15 in. two-tone alloy wheels (GT) / 15 in. black alloy wheels (LE) |
| Tires | 165/65R14 (ES/SE) / 175/55R15 (GT/LE) |
| CAPACITIES | |
| Passenger seating | 5 |
| Fuel Capacity | 9.2 gallons |
| WEIGHTS | |
| GVWR CVT (SMT) | 3,020 lbs. (2,910 lbs.) |
| Curb weight CVT (SMT) | 2,073 lbs. (2,018 lbs) / 2,095 lbs. / 2,128 lbs. |
| FUEL ECONOMY | |
| CVT City / Highway / Combined (mpg) ³ | 36/43/39 |
| SMT City / Highway / Combined (mpg) ³ | 33/41/36 |

| EXTERIOR FEATURES | ES | LE | SE | GT |
|--|-----|-----|-----|-----|
| Halogen headlights | STD | STD | STD | - |
| High Intensity Discharge (HID) headlights | - | - | - | STD |
| Fog lights | ACC | ACC | STD | STD |
| LED rear combination taillights | STD | STD | STD | STD |
| High mount rear stop light | STD | STD | STD | STD |
| Lower side air dams | STD | STD | STD | STD |
| Rear spoiler | STD | STD | STD | STD |
| Color-keyed front and rear bumpers | STD | STD | STD | STD |
| Color-keyed folding side-view mirrors | STD | - | - | - |
| Color-keyed folding side-view mirrors with turn indicators | - | - | STD | STD |
| Black folding side-view mirrors with turn indicators | - | STD | - | - |
| Color-keyed outside door handles | STD | STD | STD | STD |
| Color-keyed tailgate handle | STD | STD | STD | STD |
| Chrome grille accents | STD | STD | STD | STD |
| Front windshield variable intermittent wipers | STD | STD | STD | STD |
| Rear window intermittent wiper / washer with defroster | STD | STD | STD | STD |
| Power side-view mirrors | STD | STD | STD | STD |
| Laminated windshield | STD | STD | STD | STD |
| 14 in. steel wheels with wheel covers | STD | - | - | - |
| 14 in. alloy wheels | - | - | STD | - |
| 15 in. two-tone alloy wheels | - | - | - | STD |
| 15 in. black alloy wheels | - | STD | - | - |
| Temporary spare tire | STD | STD | STD | STD |
| Door sash black out | STD | STD | STD | STD |
| Short pole antenna | STD | STD | STD | STD |
| LE Badge | - | STD | - | - |
| SE Badge | - | - | STD | - |
| GT Badge | - | - | - | STD |

| INTERIOR FEATURES | ES | LE | SE | GT |
|---|-----|-----|-----|-----|
| Speedometer / tachometer gauge cluster | STD | STD | STD | STD |
| Semi-high contrast meter cluster with chrome accent | - | - | STD | STD |
| Front room light | STD | STD | STD | STD |
| Cargo light | STD | STD | STD | STD |
| 6-way adjustable driver's seat | STD | STD | STD | STD |
| 4-way adjustable front passenger seat | STD | STD | STD | STD |
| Driver's seat armrest | - | STD | STD | STD |
| Heated front seats | - | STD | - | STD |
| Black fabric seats with red accent surfaces | - | STD | - | - |
| Split folding rear seats | STD | STD | STD | STD |
| Rear seat head restraints (x2) | STD | STD | STD | STD |
| Leather-wrapped steering wheel | - | - | STD | STD |
| Leather-wrapped steering wheel with red stitching | - | STD | - | - |
| Urethane steering wheel | STD | - | - | - |
| Tilt steering wheel | STD | STD | STD | STD |
| Leather-wrapped shift knob | - | - | STD | STD |
| Leather-wrapped shift knob with red stitching | - | STD | - | - |
| Silver shift panel (CVT only) | STD | - | - | - |
| Gloss black shift panel | - | - | STD | STD |
| Gloss black center panel | STD | STD | STD | STD |
| Gloss black door panel accents | - | - | STD | STD |
| Red interior panel accents | - | STD | - | - |
| Material-color inner door handles | STD | STD | - | - |
| Chrome-plated front inner door handles | - | - | STD | STD |
| Chrome accented HVAC panel | STD | STD | STD | STD |
| Driver and passenger sun visors with driver's side vanity mirror, lid and ticket holder | STD | STD | STD | STD |
| Remote hood and fuel door release lever | STD | STD | STD | STD |

| CONVENIENCE FEATURES | ES | LE | SE | GT |
|--|-----|-----|-----|-----|
| 6.5 in. Smartphone Link Display Audio (SDA) System, Apple CarPlay™ and Android Auto™ compatibility and 4 speakers ^{4,5} | - | STD | STD | STD |
| Touch-panel display audio system with 4 speakers | STD | - | - | - |
| Bluetooth® wireless technology with steering wheel-mounted controls ¹ | STD | STD | STD | STD |
| USB port | STD | STD | STD | STD |
| Rearview camera | STD | STD | STD | STD |
| Steering wheel-mounted cruise control | STD | STD | STD | STD |
| Steering wheel-mounted audio controls | STD | STD | STD | STD |
| Steering wheel-mounted voice controls | - | STD | STD | STD |
| FAST-Key passive entry system with push button start and panic feature | - | - | STD | STD |
| Remote keyless entry with panic feature | STD | STD | - | - |
| Air conditioning | STD | STD | STD | STD |
| Automatic climate control | - | - | STD | STD |
| Micron air filtration | STD | STD | STD | STD |
| Rear heater floor ducts | STD | STD | STD | STD |
| Power windows | STD | STD | STD | STD |
| Power door locks | STD | STD | STD | STD |
| 12-volt accessory outlet (x1) | STD | STD | STD | STD |
| Floor console box with cup holders (x3) | STD | STD | STD | STD |
| Front door panel storage pockets | STD | STD | STD | STD |
| Front retractable assist grips (x2) | STD | STD | STD | STD |
| Glove box | STD | STD | STD | STD |
| ECO indicator light | STD | STD | STD | STD |
| SAFETY AND SECURITY | | | | |
| Hill Start Assist (HSA) | STD | STD | STD | STD |
| Anti-lock Braking System (ABS) with Electronic Brakeforce Distribution (EBD) and Brake Assist (BA) | STD | STD | STD | STD |
| Active Stability Control (ASC) | STD | STD | STD | STD |
| Tire Pressure Monitoring System (TPMS) | STD | STD | STD | STD |
| Advanced dual-stage SRS front airbags ⁷ | STD | STD | STD | STD |
| Driver's knee airbag ⁷ | STD | STD | STD | STD |
| Side curtain airbags ⁷ | STD | STD | STD | STD |
| Three-point seat belts for all seating positions | STD | STD | STD | STD |
| Adjustable front shoulder belts with pretensioner | STD | STD | STD | STD |
| LATCH child-restraint system | STD | STD | STD | STD |
| Child safety rear door locks | STD | STD | STD | STD |
| Anti-theft engine immobilizer | STD | STD | STD | STD |
| RISE body construction | STD | STD | STD | STD |

FOOTNOTES

- The Bluetooth word mark and logos are owned by the Bluetooth SIG, Inc., and any use of such marks by Mitsubishi is under license.
- Claim based on EPA.gov site GHG rating MY 2018-2019.
- Claim based on EPA estimated combined mileage of 37 MPG (Mirage G4) or 39 MPG (Mirage). EPA estimates are to be used as a standardized comparison with other vehicles. Your actual mileage will vary depending on how you drive and maintain your vehicle.
- Apple CarPlay and Siri are trademarks of Apple Inc., registered in the U.S. and other countries.
- Android, Android Auto, Google Play, Google Maps and Hangouts are trademarks of Google Inc.
- iPod is a registered trademark of Apple Inc.
- Airbags are part of a Supplemental Restraint System (SRS). To decrease the risk of injury from a deploying airbag, always wear your seat belt, sit upright in the middle of the seat, and do not lean against the door. Always place children 12 and under in the rear seat and use appropriate child restraints. Never place a rear-facing infant restraint in the front seat. See your Owner's Manual and instructions provided with your child restraint for additional information.
- ©2014 Rockford Corporation. All Rights Reserved. ROCKFORD FOSGATE, PUNCH and associated logos, where applicable, are registered trademarks of Rockford Corporation in the United States and/or other countries. Specifications subject to change without notice.

| ADDITIONAL FACTORY PACKAGES | ADDITIONAL FACTORY PACKAGES CONTINUED |
|--|--|
| Protection Package | Protection and All-Weather Value Package |
| · Front and rear mudguards | · Body side moldings |
| · Scuff plates | · Cargo tray |
| Exterior Package | · All-weather floor mats (4) |
| · LED DRLs with garnish | ES Popular Equipment Value Package |
| · Rear bumper garnish | · Armrest console |
| · Liftgate garnish | · Cargo mat |
| Cargo Package | · Cargo net |
| · Cargo mat | Limited Edition Value Package |
| · Cargo net | · Front and rear mudguards |
| Interior Package available on ES, SE and GT | · Body side moldings |
| · Gloss black accent panels | · Exhaust finisher |
| · Aluminum / leather-wrapped shift knob | · Scuff plates |
| All-Weather Package | · Black leather/aluminum shift knob |
| · All-weather floor mats (4) | |
| · Cargo tray | ACCESSORIES |
| Chrome Package available on ES and SE | Wheel Locks Available on LE, SE and GT |
| · Meter cluster chrome accent | Fog Lights Available on ES and LE |
| · Headlight chrome garnish | Color-Keyed Body Side Molding Available on all trims |
| · Liftgate garnish | All-Weather Floor Mats (4) Available on all trims |
| LED Illumination Package | Remote Engine Start Available on SE and GT |
| · Floor illumination (blue) | Side Sill Extensions Available on all trims |
| · Center console illumination (blue) | LED DRLs with Garnish Available on all trims |
| · Room lamp | Exhaust Finisher Available on all trims |
| Rockford Fosgate® Package | Carpeted Floor Mats and Portfolio Available on all trims |
| · Rockford Fosgate® 300-watt ecoPUNCH™ amplifier and subwoofers ⁸ | Front and Rear Park Assist Sensors Available on all trims |
| Popular Equipment Value Package | Armrest Console Available on ES |
| · Front and rear mudguards | Rear Park Assist Sensors Available on all trims |
| · Exhaust finisher | Front and Rear Mudguards Available on all trims |
| · Scuff plates | |
| · Black leather/aluminum shift knob | |
| · Cargo mat | |
| · Cargo net | |

WARRANTY

See retailer for limited warranty and roadside assistance terms and conditions.

| Powertrain | 10-year/100,000-mile limited | The 10-year/100,000-mile Powertrain Limited Warranty applies only to the original owner of new, retailed 2019 models purchased from an authorized Mitsubishi dealer. Subsequent owners receive the balance of the New Vehicle Limited Warranty of 5 years/60,000 miles. |
|----------------------------|------------------------------|---|
| Basic | 5-year/60,000-mile limited | |
| Anti-corrosion/perforation | 7-year/100,000-mile limited | |
| Roadside assistance | 5-year/unlimited mile | |

Log on to our website and browse our full lineup of new vehicles, get MSRP and customer rebate information and "build" the Mitsubishi that's right for you. The site can help you locate your nearest dealer – or even have a dealer contact you.

Technical data, equipment and options shown are based on the latest information available at the time of printing and are subject to change without notice. Colors may vary due to the printing process. Exterior and interior lights on vehicles shown may be illuminated for illustration purposes only. Vehicles are shown with optional equipment. Not all equipment is available on every model. For more complete details about equipment configuration and Mitsubishi Genuine Accessories, please contact your Mitsubishi Retailer.

Mitsubishi Motors North America, Inc.
6400 Katella Ave., Cypress, CA 90630-0064
1-888-MITSU2019
MITSUBISHICARS.COM