



ARB

4.2·5.2

YES.

YES ACHIEVES THE IMPOSSIBLE.

It creates progress.

It takes risks.

And it makes a statement.

What follows are the results of
refusing to yield to limitations and
instead, embracing the possibilities.

Welcome to the cars that “yes” built.



A DECADE OF SUNDAYS
ATOP THE PODIUM
IS VALIDATION OF
OUR TECHNOLOGY
AND OUR CARS.

|YES| Once a year, Audi brings its best to a little race called the 24 Hours of Le Mans. And over the past decade, we've stood atop the podium eight times.



Audi
TDI Power



BOSCH

MAHLE

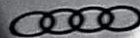

MICHELIN

MICHELIN

TDI

UNIPART



— ONE BRANCH OVER
ON THE FAMILY TREE.

|YES| The same designers who created the Le Mans-winning prototypes also designed the R8. So, to distinguish it from the racecar, they gave it a radio, roof and AC.



Audi
TDI
Power

Audi

Audi Sport TDI

E



WE LIVE
IN THE DETAILS.

|YES| The sideblades allow for personal customization of the R8 as well as channeling air to the state-of-the-art, mid-mounted engine.

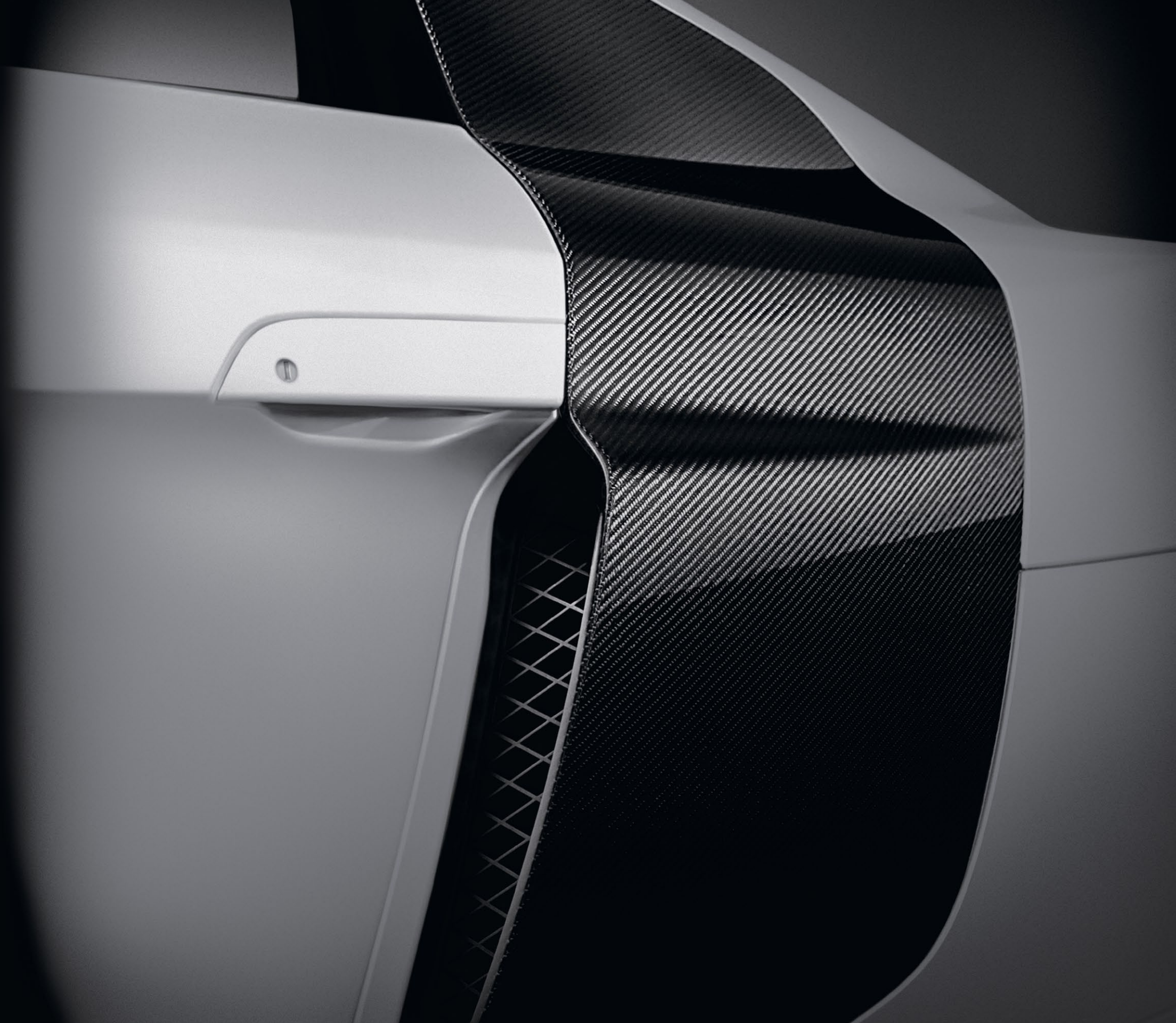



— WE DRAW INSPIRATION
FROM EVERYWHERE.

|YES| Inspired by the Sydney Opera House, full LED headlights made their world debut in the R8.



— OUR TOOLS HAVE FINGERS.

|YES| A highly skilled pair of hands continues to be the ideal tool for creating a mere 20 works of art a day.





**— WE WRUNG OUT
THE PERIODIC TABLE
OF ELEMENTS.**

|YES| We use only the most advanced composites and alloys, such as carbon fiber, magnesium and aluminum blended with silicon, all for the sole purpose of performance.

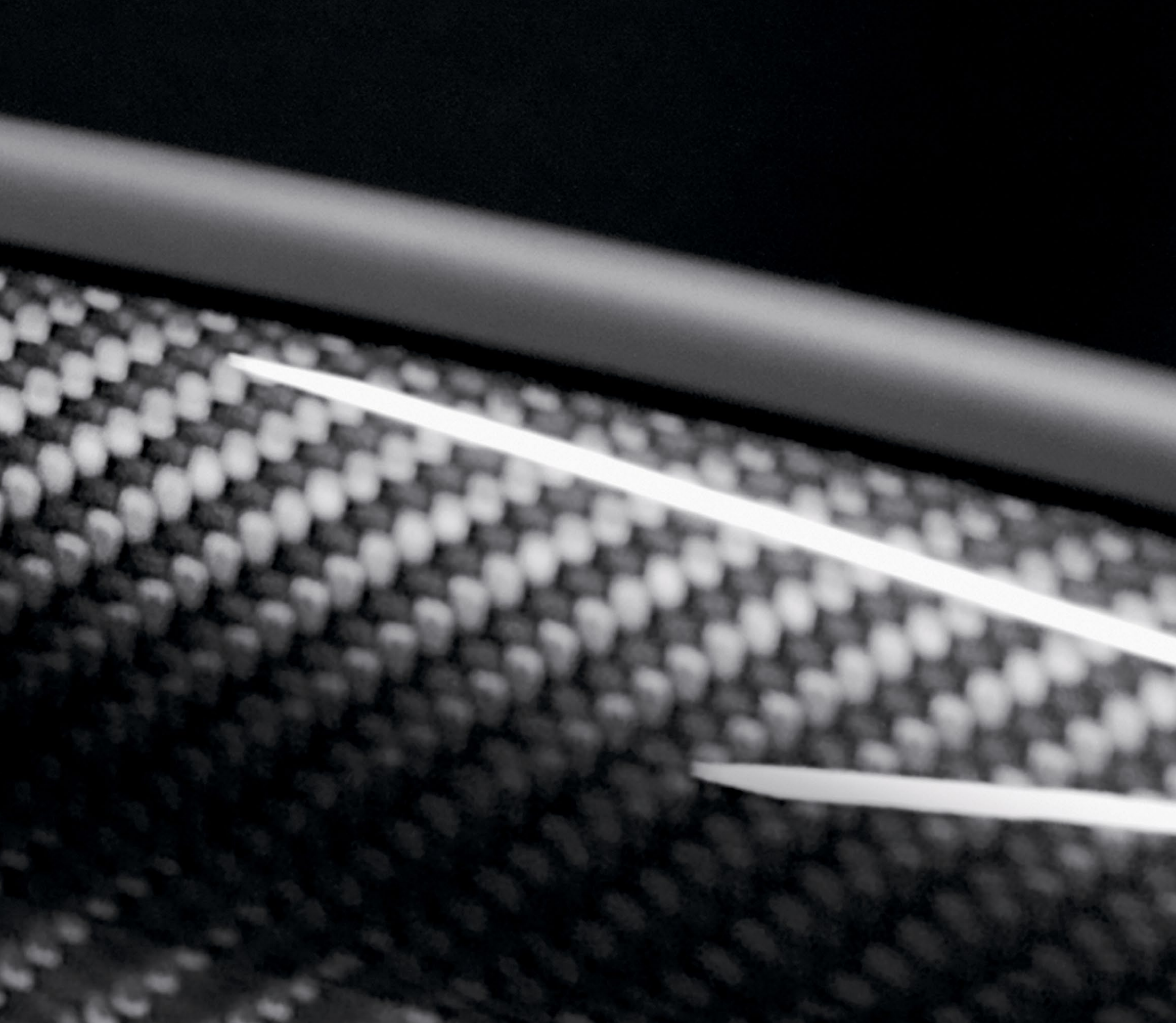



**525 HP MAKES
THE WORLD SEEM
MUCH SMALLER.**

|YES| The R8 V10: 0-60 in 3.7 seconds and a top track speed of 196 MPH*





FLIGHT SIMULATOR OR SUPERCAR?

| YES | The R8 double-wishbone aluminum suspension with quattro® all-wheel drive achieves lateral g-forces of 1.2. More g's than a Saturn V rocket in the third stage of liftoff.





TEN SCREAMING
PISTONS AND
TWO WELL-PADDED
HEADRESTS.

|YES| With a piston speed of 60 MPH at the 8700 RPM redline, it's no wonder this is the very same engine used in the R8 LMS GT3 racecar.





**0.1 SPLIT-SECOND
SHIFT TIMES.**

|YES| The R tronic[®] transmission serves up gears instantaneously, providing relentless V10 power.





FOR MORE THAN
25 YEARS, WE'VE
MOCKED THE LAWS
OF PHYSICS.

|YES| We introduced the world to the remarkable performance and handling of quattro® all-wheel drive and reset the possibilities of what a car can do.



A close-up, low-angle shot of the front left headlight of a red Audi R8. The headlight is highly detailed, showing the intricate LED daytime running light strip at the bottom and the main headlight lens above. The car's body is painted a vibrant red, and the background is dark, making the headlight stand out. The text 'DAYLIGHT AT THE FLIP OF A SWITCH.' is overlaid on the left side of the image.

DAYLIGHT AT THE
FLIP OF A SWITCH.

|YES| The first vehicle to employ a full LED headlight system. The R8 features 24 LED daytime running lights, symbolic of Audi victories at the 24 Hours of Le Mans.



R8 SPYDER













525 HP
391 LB-FT.
195 MPH*
0-60: 4.0 SEC



* Top track speed. Always obey local speed and traffic laws.



R8 5.2









AIRBAG

BOSE

RETURN
SETUP

AUTO





525 HP
391 LB-FT.
196 MPH*
0-60: 3.7 SEC





 R8 4.2













tion
-74°F
EST.

60 80 100 120 140 160 180 200 220
MPH
km/h
16.7
73
miles

DENVER WARD RESERVOIR NO
LAKEWOOD
WHEAT RIDGE
0.9mi
9.4mi
2:52 PM
TMC 2:33 PM
Destination
Nav-Info
Audi Navigation plus

RADIO CD/SD NAME TEL NAV INFO CAR

RETURN
SETUP

72 76
68 °F

AUTO

SPORT

SPORT

420 HP

317 LB-FT.

187 MPH*

0-60: 4.4 SEC





R8 4.2





R8 5.2

Note: A word about this brochure. Audi of America, Inc., believes the specifications in this brochure to be correct at the time of printing. However, specifications, standard equipment, options and colors are subject to change without notice. Some equipment may be unavailable when your vehicle is built. Please ask your dealer for advice concerning current availability of standard and optional equipment and your dealer will verify that your vehicle includes the equipment you ordered. Vehicles in this brochure are shown with optional equipment. See your dealer for complete details on the new vehicle limited warranty, twelve-year limited warranty against corrosion perforation and Audi 24/7 Roadside Assistance. [Roadside Assistance coverage provided by Road America in the U.S. Certain conditions apply, see your dealer for details.] Tires supplied by various manufacturers. "Truth in Engineering" is a trademark of Audi of America, Inc. "Audi," "quattro," "singleframe," the singleframe grille design, "R8," "FSI," "TFSI," "R tronic," "MMI," "ASF" and the four rings logo are registered trademarks of AUDI AG. "Servotronic" is a registered trademark of the AM General Corporation. "Bang & Olufsen" is a registered trademark of the Bang & Olufsen Group. "Alcantara" is a registered trademark of Alcantara S.P.A. "ESP" is a registered trademark of Daimler AG. "HomeLink" is a registered trademark of Prince Corporation, Holland, Michigan. Prince is a wholly owned subsidiary of Johnson Controls. "SIRIUS" is a registered trademark of SIRIUS Satellite Radio, Inc. "SD" is a registered trademark of SD-3C, LLC. "Bluetooth" is a registered trademark of Bluetooth SIG, Inc. "iPod" is a registered trademark of Apple, Inc.

R8 4.2 //

R8 5.2 //



The Audi R8 models are the pinnacle of Audi engineering, design and performance. They represent the realm of what is possible when there are no compromises.



audiusa.com

Audi
Truth in Engineering





R8 SPYDER

5.2 FSI® with six-speed manual transmission and quattro® all-wheel drive

5.2 FSI® with six-speed R tronic® automatic transmission and quattro® all-wheel drive

R8 SPYDER

EXTERIOR/INTERIOR DETAILS + SPECIFICATIONS

SPYDER EXTERIOR COLORS

IBIS WHITE

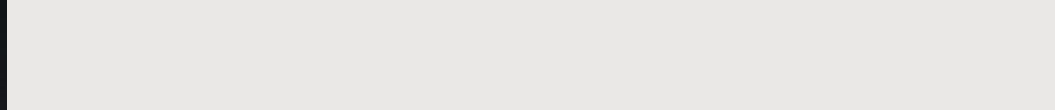

BRILLIANT RED



ICE SILVER METALLIC

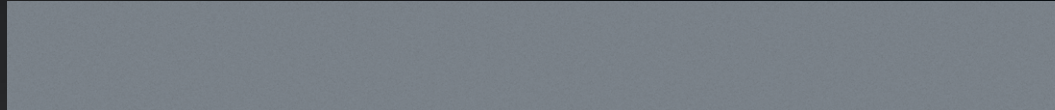

JET BLUE METALLIC



DAYTONA GRAY PEARL EFFECT



LAVA GRAY PEARL EFFECT

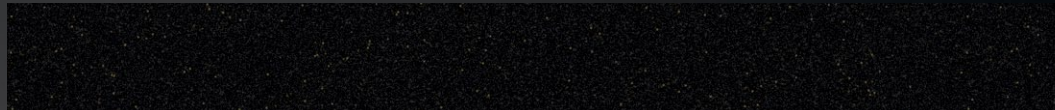

PHANTOM BLACK PEARL EFFECT



SEPANG BLUE PEARL EFFECT

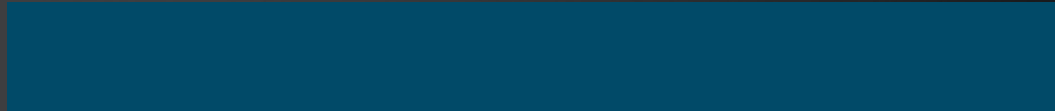

TEAK BROWN METALLIC

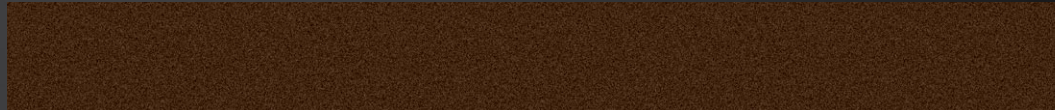

SPYDER ACOUSTIC TOP COLOR OPTIONS*

BLACK



BROWN



*Please note: Not all color combinations available; some exceptions available through the Audi exclusive vehicle personalization program.

Further customization is available through Audi exclusive. Please see your dealer for details.

SPYDER INTERIOR SEATING OPTIONS

BLACK FINE NAPPA LEATHER



LUNAR SILVER FINE NAPPA LEATHER



TITANIUM GRAY FINE NAPPA LEATHER

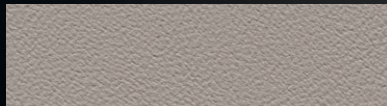

LUXOR BEIGE FINE NAPPA LEATHER

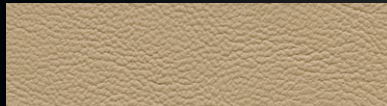

NOUGAT BROWN FINE NAPPA LEATHER

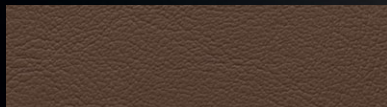

RED FINE NAPPA LEATHER

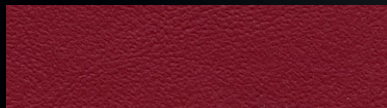

SPYDER DECORATIVE INLAY OPTIONS

CARBON FIBER SIGMA INLAY



PIANO BLACK INLAY

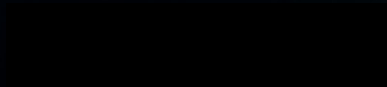

MICROMETALLIC GRAY INLAY [Standard]



SPYDER WHEEL OPTIONS

19" TEN-SPOKE, Y DESIGN WHEELS [Standard]



19" FIVE-ARM, DOUBLE-SPOKE TITANIUM FINISH WHEELS



19" FIVE-ARM, DOUBLE-SPOKE POLISHED WHEELS



19" FIVE-ARM, DOUBLE-SPOKE WHEELS

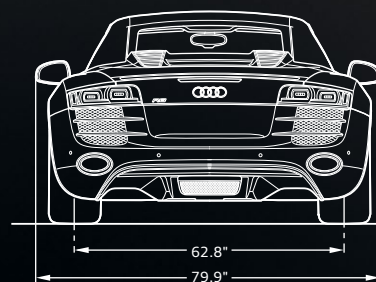
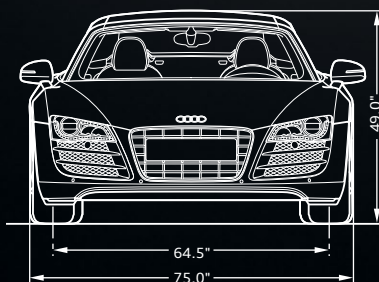
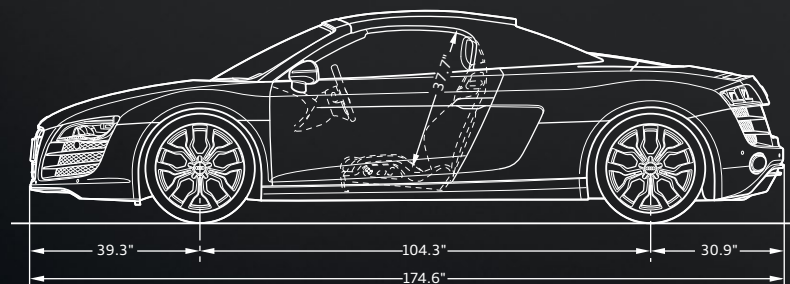

R8 SPYDER



Engine/Performance

5.2 liter DOHC V10, four valves per cylinder, with FSI* direct injection, dry sump lubrication system, aluminum cylinder block and crank case

Displacement: 5.2 liters [317.6 cu.in.]

Bore: 3.33 in. | Stroke: 3.65 in. | Compression Ratio: 12.5:1

Horsepower: 525 @ 8000 RPM | Torque: 391 lb-ft. @ 6500 RPM

0 - 60: 4.0 seconds | Top track speed: 195 MPH | Lateral Acceleration: 1.2g

Fuel economy estimate, city/highway: N/A at time of printing

Chassis/Technical [Standard]

Six-speed manual transmission

Six-speed R tronic* sequential automatic transmission [Option]

Audi Space Frame [ASF*]

Aluminum double-wishbone front and rear suspension

Audi magnetic ride

quattro* permanent all-wheel drive with rear-biased torque distribution

14.4" perforated and internally ventilated front brake rotors with eight piston calipers

14" perforated and internally ventilated rear brake rotors with four piston calipers

Safety [Standard]

The greatest complement to superior performance is uncompromised safety. The R8 Spyder naturally features a number of active and passive safety systems.

Integrated active roll-over protection system with spring-tensioned roll bars

Rigid body, side intrusion beams, and energy-absorbing crumple zones at the front and rear

Driver and passenger knee airbags*

Driver and passenger seat-mounted head and thorax airbags*

Driver and passenger advanced dual-stage airbags*

LED Lighting [Standard]

The Audi R8 Spyder offers a full LED headlight system. This means the headlights [including high and low beams], turn indicators and daytime running lights are fully LED.

The rear lights are also LED, offering the benefit of rapid response once the brake pedal is depressed. LED lighting technology is also found in the interior lighting and the turn indicators integrated into the exterior mirror housings.

Exterior [Standard]

The Audi R8 Spyder is peerless in performance and design. The specially designed acoustic top incorporates three layers of insulation for year-round comfort and an interior acoustic level comparable to a traditional coupe. Visually, the R8 Spyder stands out as well with high-gloss black exterior elements such as the aggressive Singleframe* grille, front lip spoiler, rear diffuser, front air inlet and rear air outlet grilles.

The engine compartment cover and rear side panels are constructed from innovative Carbon Fiber reinforced polymers for optimal weight distribution.

Dual-oval chrome exhaust pipes, Aluminum Optic engine vents and a retractable rear spoiler also hint at its performance potential. Adding to the aggressive yet understated look are dramatic 19" ten-spoke, Y design wheels with summer performance tires†. Rounding out the exterior features are body color, heated, power-folding mirrors with auto-dimming capabilities.

Infotainment/Technology [Standard]

The Audi R8 Spyder is brimming with technological enhancements, enabling you to make the most of every drive.

Audi Navigation plus with real-time traffic

Audi parking system plus with rearview camera - includes ultrasonic sensors for both front and rear of vehicle

Bang & Olufsen* Sound System - 465 watts, twelve speakers including a center speaker and subwoofer, ten channel amplifier and vehicle noise compensation

SIRIUS* Satellite Radio

HomeLink* universal remote control

Bluetooth* mobile phone interface with safety belt microphone

Interior [Standard]

The Audi R8 Spyder interior strikes the perfect balance between absolute performance and supreme luxury by utilizing innovative technology, while integrating only the finest materials.

Fine Nappa leather sport seats with thermal resistant properties

Ten-way, power-adjustable, heated seats including four-way lumbar support

Aluminum Optic accelerator, brake and footrest [includes clutch pedal with manual transmission]

Leather-wrapped, magnesium, three-spoke, flat-bottom multifunction sport steering wheel

Micro-metallic Gray interior inlays

Auto-dimming interior mirror with digital compass

Options

The Audi R8 Spyder is ideal for personal customization. Select from a number of interior and exterior options to make the R8 Spyder uniquely yours.

Carbon Fiber Sigma or Piano Black interior inlays

Carbon Fiber Sigma doorsill inserts

Carbon Fiber Sigma exterior mirrors

Carbon Fiber Sigma Exterior Package: Includes front spoiler lip and rear diffuser

Illuminated doorsill inserts

Enhanced Leather Package: Additional leather elements including dash and door trim

Audi Navigation plus with Audi music interface and iPod* cable

19" five-arm, double-spoke wheels with summer performance tires‡

19" five-arm, double-spoke polished or Titanium finish wheels with summer performance tires‡

* Always obey all local speed and traffic laws. Top track speed measured with summer performance tires and requires tires with proper speed rating. Check your owner's manual or dealer for details.

† EPA estimates; your mileage will vary.

‡ Airbags are supplemental restraints only and will not deploy in all crash circumstances. Always use safety belts and refer to your owner's manual for the proper use of the restraint systems when transporting children.

§ Summer performance tires are designed for optimum performance and handling in warm climates. They are not suitable for cold, snowy or icy weather conditions. If you drive under those circumstances, you should equip your vehicle with all-season or winter tires, which offer better traction under those conditions. We suggest you use the recommended winter or all-season tires specified for your car or their equivalent. These summer performance tires also have a lower aspect ratio that aids performance and handling. However, in order to avoid tire, rim or vehicle damage, it is important that the inflation pressure is regularly checked and maintained at recommended levels. Serious wheel and tire damage may occur if the vehicle is operated on rough or damaged road surfaces, or upon encountering road debris or obstacles. Please also remember in making your selection that, while these tires deliver responsive handling, they may ride less comfortably and make more noise than other choices. Finally, these tires may wear more quickly than other choices. For more information on all of these topics, please consult the owner's manual, your local dealer or call 1-800-FOR-AUDI.



R8 5.2

5.2 FSI* with six-speed manual transmission and quattro* all-wheel drive

5.2 FSI* with six-speed R tronic* automatic transmission and quattro* all-wheel drive

R8 5.2 EXTERIOR/INTERIOR DETAILS + SPECIFICATIONS

5.2 EXTERIOR COLORS WITH STANDARD SIDEBLADE COMBINATION

IBIS WHITE WITH ICE SILVER METALLIC SIDEBLADE



BRILLIANT RED WITH BRILLIANT RED SIDEBLADE



ICE SILVER METALLIC WITH APOLLO SILVER METALLIC SIDEBLADE



JET BLUE METALLIC WITH ICE SILVER METALLIC SIDEBLADE



DAYTONA GRAY PEARL EFFECT WITH QUARTZ GRAY METALLIC SIDEBLADE



LAVA GRAY PEARL EFFECT WITH QUARTZ GRAY METALLIC SIDEBLADE



PHANTOM BLACK PEARL EFFECT WITH LAVA GRAY PEARL EFFECT SIDEBLADE

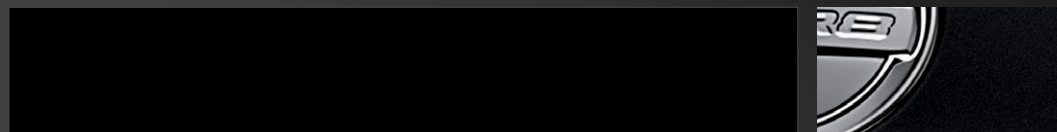

SEPANG BLUE PEARL EFFECT WITH MUGELLO BLUE PEARL EFFECT SIDEBLADE

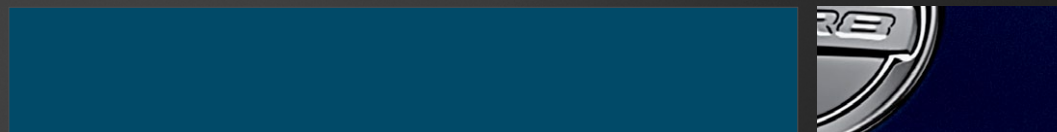

5.2 OPTIONAL SIDEBLADES

MATCHING BODY COLOR



OXYGEN SILVER



CARBON FIBER SIGMA



Further customization is available through Audi Exclusive. Please see your dealer for details.

5.2 INTERIOR SEATING OPTIONS

BLACK FINE NAPPA LEATHER



LIMESTONE GRAY FINE NAPPA LEATHER

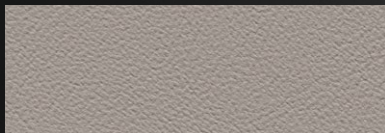

LUXOR BEIGE FINE NAPPA LEATHER

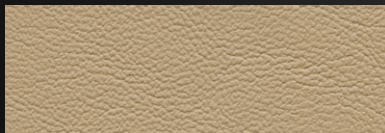

TUSCAN BROWN FINE NAPPA LEATHER

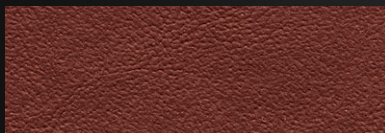

RED FINE NAPPA LEATHER

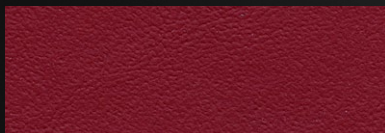

5.2 DECORATIVE INLAY OPTIONS

CARBON FIBER SIGMA INLAY

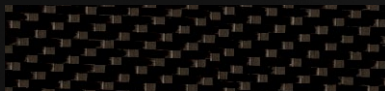

PIANO BLACK INLAY

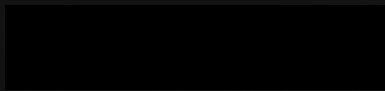

MICROMETALLIC GRAY INLAY [Standard]



5.2 WHEEL OPTIONS

19" TEN-SPOKE, Y DESIGN WHEELS [Standard]



19" FIVE-ARM, DOUBLE-SPOKE TITANIUM FINISH WHEELS



19" FIVE-ARM, DOUBLE-SPOKE POLISHED WHEELS



19" FIVE-ARM, DOUBLE-SPOKE WHEELS

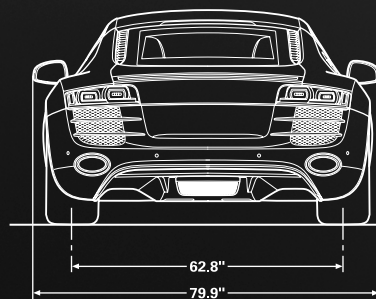
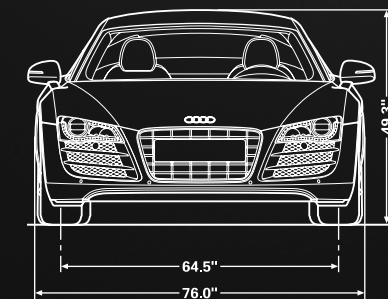
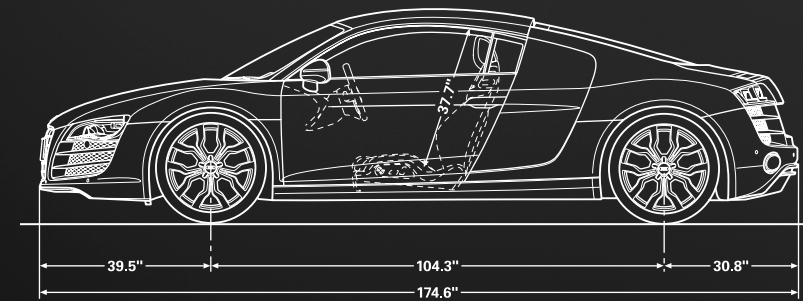

R8 5.2



Engine/Performance

5.2 liter DOHC V10, four valves per cylinder, with FSI* direct injection, dry sump lubrication system, aluminum cylinder block and crank case

Displacement: 5.2 liters [317.6 cu.in.]

Bore: 3.33 in. | Stroke: 3.65 in. | Compression Ratio: 12.5:1

Horsepower: 525 @ 8000 rpm | Torque: 391 lb-ft. @ 6500 rpm

0-60: 3.7 seconds | Top track speed*: 196 MPH | Lateral Acceleration: 1.2g

Fuel economy estimate, city/highway*: Manual: 12/20 MPG, R tronic*: 13/20 MPG

Chassis/Technical [Standard]

Six-speed manual transmission

Six-speed R tronic* sequential automatic transmission [Option]

Audi Space Frame [ASF*]

Aluminum double-wishbone front and rear suspension

Audi magnetic ride

quattro* permanent all-wheel drive with 15:85-30:70 rear-biased torque distribution

14.4" perforated and internally ventilated front brake rotors with eight piston calipers

14" perforated and internally ventilated rear brake rotors with four piston calipers

Safety [Standard]

The greatest complement to superior performance is uncompromised safety. The R8 5.2 naturally features a number of active and passive safety systems.

Rigid body shell with reinforced occupant cell, side intrusion beams, and energy absorbing crumple zones at the front and rear

Driver and passenger knee airbags*

Driver and passenger seat-mounted head and thorax airbags*

Driver and passenger advanced dual-stage airbags*

LED Lighting [Standard]

The Audi R8 5.2 is the first vehicle in the world to offer a full LED headlight system. This means the headlights [including high and low beams], turn indicators and daytime running lights are fully LED.

The rear lights are also LED, offering the safety of rapid response once the brake pedal is depressed. LED lighting technology is also found in the turn indicators integrated into the exterior mirror housings, and the dramatic engine compartment features LED illumination.

Exterior [Standard]

The Audi R8 5.2 is peerless in performance and design, so it stands to reason that it incorporates a number of unique visual items. The 5.2 features flared rocker panels and sideblades as well as high-gloss Black exterior elements such as the aggressive singleframe* grille, front lip spoiler, rear diffuser, front air inlet and rear air outlet grilles. The engine compartment itself is a work of art. Gaze through the transparent panel and admire the Carbon Fiber Sigma surrounding the engine and Aluminum Optic vents that cap off an elegant rear roofline.

Dual-oval chrome exhaust pipes and a retractable rear spoiler both hint at the performance potential. Adding to the aggressive yet understated look are dramatic 19" ten-spoke, Y design wheels with summer performance tires[§]

Rounding out the exterior features are body color, heated, power-folding mirrors with auto-dimming capabilities.

Infotainment/Technology [Standard]

The Audi R8 5.2 is brimming with technological enhancements, enabling you to make the most of every drive.

Audi Navigation plus with real-time traffic

Audi parking system plus with rearview camera – includes ultrasonic sensors for both front and rear of vehicle

Bang & Olufsen* Sound System – 465 watts, twelve speakers including a center speaker and subwoofer, ten channel amplifier and vehicle noise compensation

SIRIUS* Satellite Radio

HomeLink* and Bluetooth*

Interior [Standard]

The Audi R8 5.2 interior strikes the perfect balance between absolute performance and supreme luxury by utilizing innovative technology, while integrating only the finest materials.

Fine Nappa leather sport seats

Ten-way power-adjustable, heated seats including four-way lumbar support

Aluminum Optic accelerator, brake and clutch pedals

Leather-wrapped, three-spoke, flat-bottom multifunction sport steering wheel

Micrometallic Gray interior inlays

Auto-dimming interior mirror with digital compass

Automatic climate control

Tilt and telescopic manually adjustable steering column

Options

The Audi R8 5.2 is ideal for personal customization. Select from a number of interior and exterior options to make the R8 5.2 uniquely yours.

Carbon Fiber Sigma or Piano Black inlays

Carbon Fiber Sigma doorsill inserts

Carbon Fiber Sigma exterior mirrors

Carbon Fiber Sigma Exterior Package: includes front spoiler lip and rear diffuser

Alcantara* headliner

Audi music interface with iPod* integration

19" five-arm, double-spoke wheels with summer performance tires[§]

19" five-arm, double-spoke polished or Titanium wheels with summer performance tires[§]

*Always obey all local speed and traffic laws. Top track speed measured with summer performance tires and requires tires with proper speed rating. Check your owner's manual or dealer for details.

†EPA estimate; your mileage will vary.

*Airbags are supplemental restraints only and will not deploy in all crash circumstances. Always use safety belts and refer to your owner's manual for the proper use of the restraint systems when transporting children.

§Summer performance tires are designed for optimum performance and handling in warm climates. They are not suitable for cold, snowy or icy weather conditions. If you drive under those circumstances, you should equip your vehicle with all-season or winter tires, which offer better traction under those conditions. We suggest you use the recommended winter or all-season tires specified for your car or their equivalent. These summer performance tires also have a lower aspect ratio that aids performance and handling. However, in order to avoid tire, rim or vehicle damage, it is important that the inflation pressure is regularly checked and maintained at recommended levels. Serious wheel and tire damage may occur if the vehicle is operated on rough or damaged road surfaces, or upon encountering road debris or obstacles. Please also remember in making your selection that, while these tires deliver responsive handling, they may ride less comfortably and make more noise than other choices. Finally, these tires may wear more quickly than other choices. For more information on all of these topics, please consult the owner's manual, your local dealer or call 1-800-FOR-AUDI.



 **R8 4.2**

4.2 FSI[®] with six-speed manual transmission and quattro[®] all-wheel drive

4.2 FSI[®] with six-speed R tronic[®] automatic transmission and quattro[®] all-wheel drive

R8 4.2 EXTERIOR/INTERIOR DETAILS + SPECIFICATIONS

4.2 EXTERIOR COLORS WITH STANDARD SIDEBLADE COMBINATION

IBIS WHITE WITH ICE SILVER METALLIC SIDEBLADE



BRILLIANT RED WITH BRILLIANT RED SIDEBLADE



ICE SILVER METALLIC WITH APOLLO SILVER METALLIC SIDEBLADE



JET BLUE METALLIC WITH ICE SILVER METALLIC SIDEBLADE



DAYTONA GRAY PEARL EFFECT WITH QUARTZ GRAY METALLIC SIDEBLADE

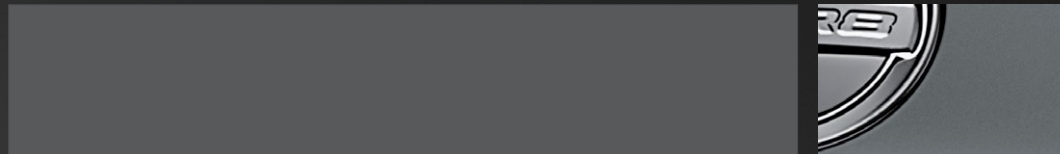

LAVA GRAY PEARL EFFECT WITH QUARTZ GRAY METALLIC SIDEBLADE



PHANTOM BLACK PEARL EFFECT WITH LAVA GRAY PEARL EFFECT SIDEBLADE



4.2 OPTIONAL SIDEBLADES

MATCHING BODY COLOR



OXYGEN SILVER



CARBON FIBER SIGMA



Further customization is available through Audi Exclusive. Please see your dealer for details.

4.2 INTERIOR SEATING OPTIONS

BLACK FINE NAPPA LEATHER OR LEATHER/ALCANTARA*



LIMESTONE GRAY FINE NAPPA LEATHER OR LEATHER/ALCANTARA*

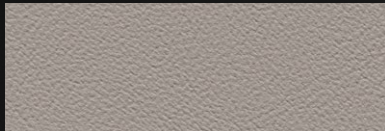

LUXOR BEIGE FINE NAPPA LEATHER

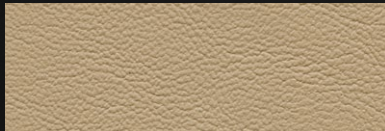

TUSCAN BROWN FINE NAPPA LEATHER

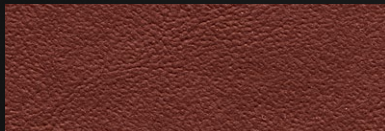

RED FINE NAPPA LEATHER



4.2 DECORATIVE INLAY OPTIONS

CARBON FIBER SIGMA INLAY

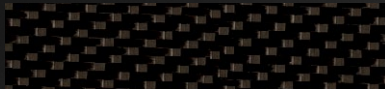

PIANO BLACK INLAY



MICROMETALLIC GRAY INLAY [Standard]



4.2 WHEEL OPTIONS

19" FIVE-ARM, DOUBLE-SPOKE WHEELS [Standard]



19" FIVE-ARM, DOUBLE-SPOKE POLISHED WHEELS



19" FIVE-ARM, DOUBLE-SPOKE TITANIUM FINISH WHEELS

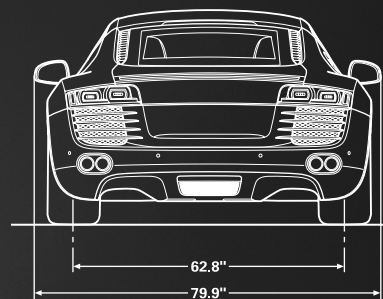
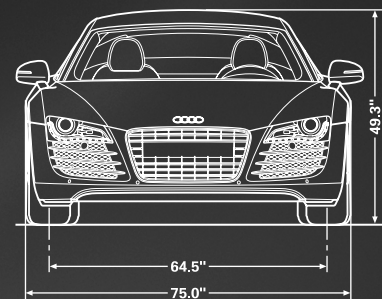
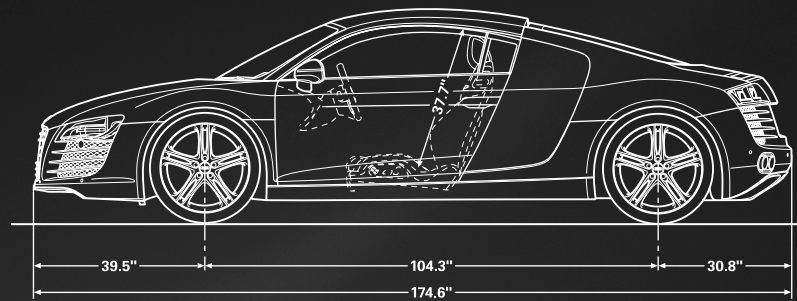

R8 4.2



Engine/Performance

4.2 liter DOHC V8, four valves per cylinder, with FSI* direct injection, dry sump lubrication system and aluminum cylinder block, crank case and cylinder heads

Displacement: 4.2 liters [254 cu.in.]

Bore: 3.33 in. | Stroke: 3.65 in. | Compression Ratio: 12.5:1

Horsepower: 420 @ 7800 rpm | Torque: 317 lb-ft. @ 4500-6000 rpm

0-60: 4.4 seconds | Top track speed*: 187 MPH

Fuel economy estimate, city/highway*: Manual: 12/19 MPG, R tronic*: 13/18 MPG

Chassis/Technical [Standard]

Six-speed manual transmission

Six-speed R tronic* sequential automatic transmission [Option]

Audi Space Frame [ASF*]

Aluminum double-wishbone front and rear suspension

Audi magnetic ride

quattro* permanent all-wheel drive with 10:90-35:65 rear-biased torque distribution

14.4" perforated and internally ventilated front brake rotors with eight piston calipers

14" perforated and internally ventilated rear brake rotors with four piston calipers

Safety [Standard]

The greatest complement to superior performance is uncompromised safety. The R8 4.2 naturally features a number of active and passive safety systems.

Rigid body shell with reinforced occupant cell, side intrusion beams, and energy-absorbing crumple zones at the front and rear

Driver and passenger knee airbags*

Driver and passenger seat-mounted head and thorax airbags*

Driver and passenger advanced dual-stage airbags*

LED Lighting [Standard]

The Audi R8 4.2 has set the standard for dramatic lighting with its iconic LED daytime running lights. The Audi xenon plus headlights offer exceptional brightness even in challenging conditions.

The rear lights are LED as well, offering the safety of rapid response once the brake pedal is depressed. LED lighting technology is also found in the turn indicators integrated into the exterior mirror housings, and the dramatic engine compartment features LED illumination.

Exterior [Standard]

The Audi R8 4.2 exterior is a showcase of progressive design and the embodiment of world-class performance. The R8 4.2 features an aggressive high-gloss Black singleframe* grille and the standard tone-on-tone contrast sideblades create a striking and unique look that is unmistakably Audi.

Quad-chrome exhaust pipes as well as a retractable rear spoiler accentuate the performance capabilities waiting to be discovered. Adding to the dramatic profile are the 19" five-arm, double-spoke wheels with summer performance tires.†

Rounding out the exterior features are body color, heated, power-adjustable mirrors.

Infotainment/Technology [Standard]

The Audi R8 4.2 is brimming with technological enhancements, enabling you to make the most of every drive.

Audi concert AM/FM stereo with in-dash CD player, including MP3 CD capability

SIRIUS* Satellite Radio

HomeLink* and Bluetooth*

Interior [Standard]

The Audi R8 4.2 interior strikes the perfect balance between absolute performance and supreme luxury by utilizing innovative technology, while integrating only the finest materials.

Leather/Alcantara* sport seats

Ten-way power-adjustable, heated seats including four-way lumbar support

Aluminum Optic accelerator, brake and clutch pedals

Leather-wrapped, three-spoke, flat-bottom multifunction sport steering wheel

Micrometallic Gray interior inlays

Auto-dimming interior mirror with digital compass

Automatic climate control

Tilt and telescopic manually adjustable steering column

Options

The Audi R8 4.2 is ideal for personal customization. Select from a number of interior and exterior options to make the R8 4.2 uniquely yours.

Full LED headlights, including high and low beams, turn indicators and daytime running lights

Audi Navigation plus with real-time traffic

Audi parking system plus with rearview camera – includes ultrasonic sensors for both front and rear of vehicle

Bang & Olufsen* Sound System – 465 watts, twelve speakers including a center speaker and subwoofer, ten-channel amplifier and vehicle noise compensation

Audi music interface with iPod* integration

Fine Nappa leather seats

Carbon Fiber Sigma or Piano Black inlays

Carbon Fiber Sigma engine compartment inlays

Carbon Fiber Sigma doorsill inserts

Carbon Fiber Sigma exterior mirrors

Carbon Fiber Sigma Exterior Package: includes front spoiler lip and rear diffuser

Alcantara* headliner

Power-folding, auto-dimming, power-adjustable, heated exterior mirrors in body color

19" five-arm, double-spoke polished or Titanium wheels with summer performance tires†

*Always obey all local speed and traffic laws. Top track speed measured with summer performance tires and requires tires with proper speed rating. Check your owner's manual or dealer for details.

†EPA estimate; your mileage will vary.

*Airbags are supplemental restraints only and will not deploy in all crash circumstances. Always use safety belts and refer to your owner's manual for the proper use of the restraint systems when transporting children.

† Summer performance tires are designed for optimum performance and handling in warm climates. They are not suitable for cold, snowy or icy weather conditions. If you drive under those circumstances, you should equip your vehicle with all-season or winter tires, which offer better traction under those conditions. We suggest you use the recommended winter or all-season tires specified for your car or their equivalent. These summer performance tires also have a lower aspect ratio that aids performance and handling. However, in order to avoid tire, rim or vehicle damage, it is important that the inflation pressure is regularly checked and maintained at recommended levels. Serious wheel and tire damage may occur if the vehicle is operated on rough or damaged road surfaces, or upon encountering road debris or obstacles. Please also remember in making your selection that, while these tires deliver responsive handling, they may ride less comfortably and make more noise than other choices. Finally, these tires may wear more quickly than other choices. For more information on all of these topics, please consult the owner's manual, your local dealer or call 1-800-FOR-AUDI.