

Q3

Audi Q3



Audi
Truth in Engineering



If it was this easy, it wouldn't be an Audi.

Obsession



IMAGINE DEVOTING YOUR LIFE TO BUILDING YOUR MODEL.

When you were a kid, you probably felt quite proud when you completed a model kit. We understand. At Audi, it takes countless hours for a single Audi to go from idea to design to roadworthy, and that's time we are very proud to devote. Our obsession for detail,

commitment to premium fit and finish and passion for unparalleled engineering go into every model. It's the kind of discipline that the word "painstaking" was invented to describe. Not to say it's a chore—no, assembling an Audi is a labor of love, and it shows every time you sit in one, engage the ignition and nudge the accelerator. Creating an Audi isn't easy, but the results help define what Audi means to the people who drive one.

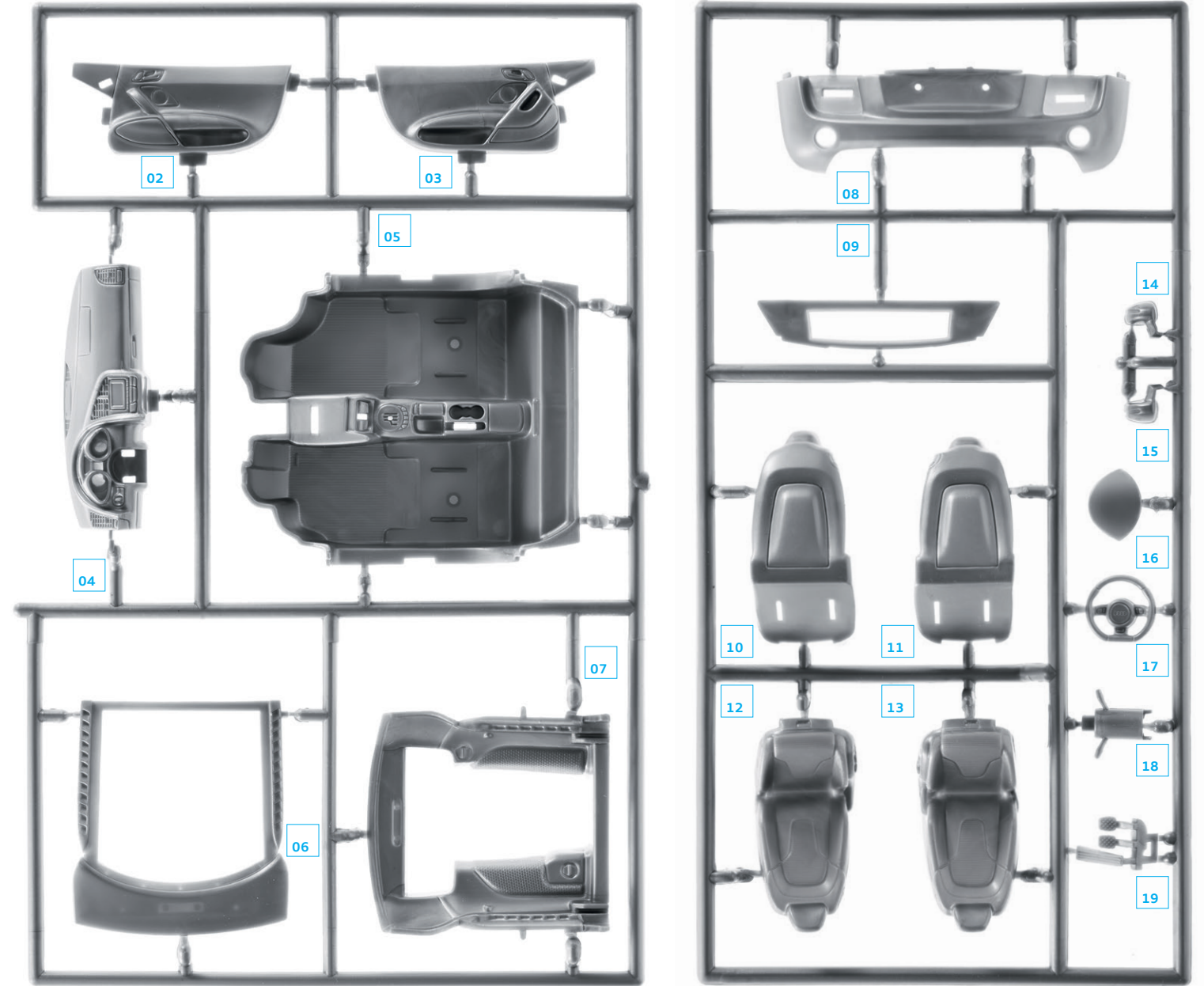



The door of perception.

OUR REPUTATION HINGES ON THE QUALITY OF THINGS YOU DON'T SEE.

It's said that, when one door closes, another one opens. It sounds as if whoever said it spent some time at an Audi research and development facility. After all, while you'll open and close the door on your Audi thousands of times without thinking about it, we've obsessed about it for you, in detail. Not just about the reliability of it opening and

closing, but on the proper weight that will make it more pleasing to close. How the locks should click when they are engaged. The optimal acoustic placement for the speaker port. There are the hinges too, of course. And the door itself, which we designed to take the brunt of side-impact collisions, and several dozen other safety considerations (to say nothing of the countless other components, processors, sensors, window features and the inner workings most people will never see). Our doors are more than a symbol of welcoming you into your vehicle, they are products of Audi engineering, and the very perception of Audi hinges on them as much as our hinges help support the door.

ACOUSTIC ENHANCEMENTS

We use soft mounts on our window regulator and a sound-absorbing backing within the door cavity itself to make the cabin even quieter.

INNOVATIVE DESIGN

By using fully pressed aluminum doors in the Audi A6, the door structures were reduced by an astonishing 44 lb compared to the previous model.

SPEAKER PLACEMENT

Optimal speaker placement helps deliver the most extraordinary sound you can find in the automotive space.

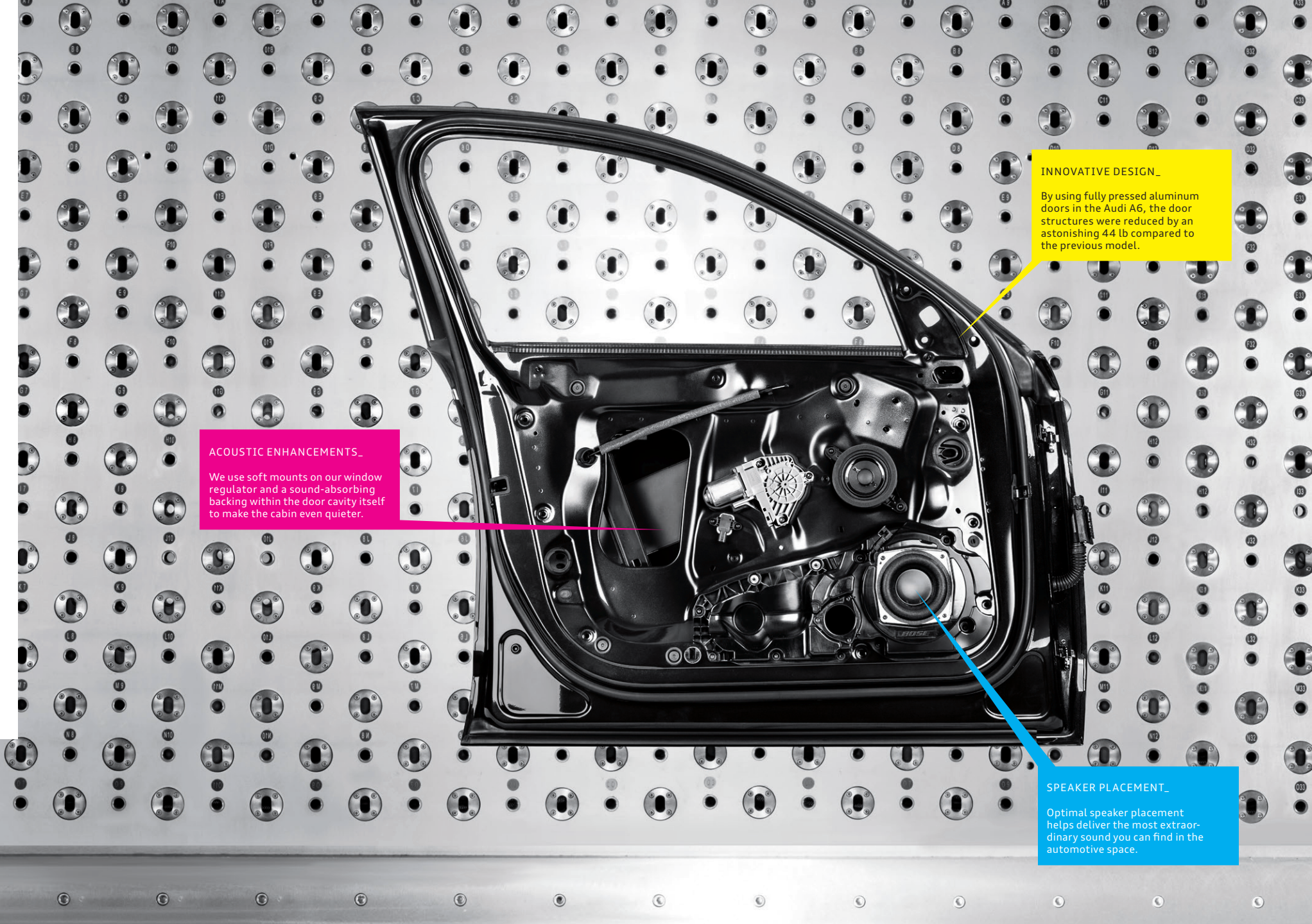

When we think of a good idea, it sticks.



SURFACES

WET
DRY
SLIPPERY
UNEVEN

Torque is distributed to all four wheels in varying amounts.

Torque vectoring

By independently braking the inside cornering wheels, torque is then transferred to the outside cornering wheels. This intelligent application of power, known as torque vectoring, is available on select quattro® models and helps promote neutral handling by calculating the driver's steering input and desired level of acceleration.

Sport differential

To help ensure high cornering agility, the available sport differential uses torque vectoring, and then adds to that by mechanically applying additional torque to the outside rear cornering wheel. Through an electrohydraulic multiplate clutch pack and gear-set, the outside rear cornering wheel speed is increased by as much as 10%.

CORNERS

CURVES
MOUNTAINS
OBSTACLES
HANDLING
UNEXPECTED

Impressive stability, more assured road-holding, enhanced agility and improved steering precision.

TRACTION

ACCELERATION
TOWING
SNOW
CRUISING
GRAVEL

quattro® directs the amount of torque required to suit the job at hand.

quattro® HAS MAINTAINED ITS GRIP ON OUR THINKING AND THE ROADS WE TRAVEL.

For more than 30 years, Audi has been focused on quattro® all-wheel drive. During that time, it has evolved into an overarching idea of performance, a technological system of ratios, power delivery and driving dynamics working seamlessly together, orchestrated through the drivetrain, providing power where and when it is needed most. In

many ways, this has been a three-decade drive, from the Alps to the autobahn—and points beyond. You've seen quattro® capabilities in the way we dominated the World Rally Championship for years, in the grip you have in inclement weather, and in the variable power distribution you enjoy in good conditions.¹ For more than 30 years, and with over five million quattro® systems on the road, we have continued to refine the technology, developing an available rear sport differential to help maximize performance and available torque vectoring to assist with cornering traction while helping to improve handling. We've boldly stuck to what worked while the world was trying to catch up, and we built on it.

¹ When driving during cold, rainy, snowy or icy weather conditions, ensure that your vehicle is equipped with appropriate all-season or winter tires. Even with appropriate tires, you must always drive in a manner appropriate for the weather, visibility and road conditions.

The obsessive engineering of maximum fitness.

ENGINEERING POWER IS MORE THAN JUST ADDING MUSCLE.

There is an art to fitness. Yes, there are some who go for the massive, sculptured muscle look. But there is something more compelling out there for those with more refined tastes. The kind of sculpted efficiency found in Audi engines elevates the driving experience through smaller, finely tuned forced-

induction engines. For the drive to feel lean and precise, we've shaved off unwanted pounds. Sure, large numbers might distract some, but a champion impresses with its grace, power and athletic balance—captured in the right suspension setting, or a torque-vectoring corner. Audi engineers taste strength that pulses at the moment of acceleration, provides a true, quick response as you change lanes, and turns the most routine cloverleaf into a joyful application of performance handling¹. This is the art of maximum fitness, to the point where others just feel a little flabby.

FSI[®]

The FSI direct injection fuel system directly injects fuel into the combustion chambers at precisely managed times and depths. What that means for drivers is that a fully homogenized intake charge helps increase power while also reducing fuel consumption and emissions, making efficiency more powerful.

TFSI[®]

At Audi, TFSI represents a combination of two of the brand's core areas of expertise—direct injection and forced induction. By adding turbocharging or supercharging to FSI direct injection, the pressurized intake charge is cooled by directly injected fuel, thus achieving efficiency and performance combined with higher compression ratios—previously only attainable by naturally aspirated engines.²

TDI[®]

A turbocharged, fuel-sipping variant, our TDI[®] clean diesel engines deliver uncompromising Audi performance with bold efficiency¹. Yes, it gets better mileage per gallon than comparable gasoline engines²; but it also produces more low-end torque, which is best expressed in the elasticity you have when passing in the 30- to 60-mph range.

¹ Always obey all speed and traffic laws.
² See www.fueleconomy.gov for EPA estimates and emissions data. Your mileage and emissions will vary and depend on several factors, including your driving habits and vehicle condition.

ELEPHANT SKULL_

How nature solved the apparent conundrum of an elephant's skull didn't escape the notice of Heinrich Timm, the longtime lead engineer for Audi. The weight of the tusks and the general size of an elephant's head would seem to make it impossible for the animal to actually be able to carry it. But the design genius behind the elephant's skull is to make it lightweight yet sturdy. Its predominantly hollow design is buffered by thin, connective bone walls, which act as strong, weight-bearing cells. Audi designers used that idea when building our aluminum and steel structures. Reducing weight, yet enabling strength.



ultra

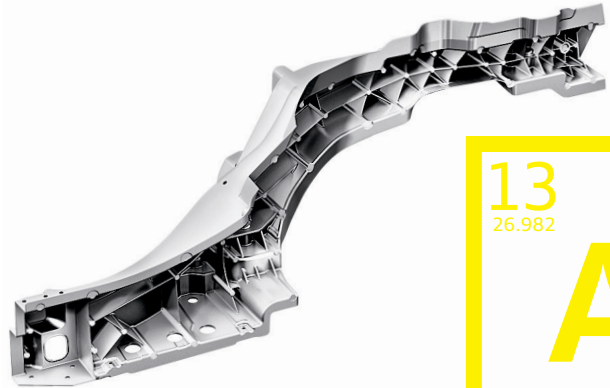

13
26.982

AU

ALUMINUM_

Our large aluminum castings are a telling example of ultra lightweight technology. Primarily used in high-stress areas, these castings achieve exceptional rigidity while also allowing for freedom of design, all while remaining extremely lightweight!

How studying elephant skulls makes for superior handling.

THE ELEGANT STRUCTURE OF NATURE BECOMES A BLUEPRINT OF EFFICIENCY.

It seems strange to say that, while we build strong, complex and high-performing machines, we're naturalists at heart. Then again, it might not be that unusual, seeing how nature itself builds strong, complex and high-performing machines as well. When we developed the thinking behind our ultra® lightweight technology initiative,

we knew that nature would serve as an inspiration to greater structural efficiency. Take the structure of the elephant skull pictured here. It has to be lightweight, yet capable of carrying a heavy load. It's porous, but its structure is such that it enhances its stability and strength. We do the same, for example, with aluminum. Positioned one way, aluminum materials can be flexible. Positioned another, they are strong and rigid, and help give better support. We also looked to bamboo, which is strong at the conjoined areas (nodes), and flexible along its stem. Our designs allow for both rigidity and flexibility where each is most needed, and for efficiency overall. As we continue to develop strategies to improve the performance aspects and efficiency of our vehicles, we don't shy away from the world around us? We boldly engage it even closer still.

1. Features and technologies listed are not available on all models. 2. See www.fueleconomy.gov for EPA estimates and emissions data. Your mileage and emissions will vary and depend on several factors, including your driving habits and vehicle condition.

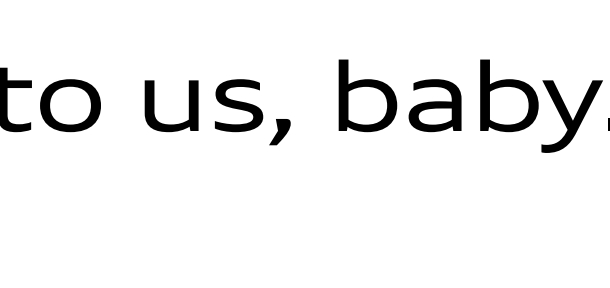

Just talk to us, baby.



AUDI CONNECT® REALLY GETS WHAT YOU ARE SAYING.

Share what's on your mind. Looking for a great Chinese food place? We'll help you get there. Thinking about a rest stop? We'll locate the nearest gas station for you, and even give you the price of their fuel. In fact, in your Audi, just say the word, and we'll help you find almost anything, even your home phone number. With available Audi connect with Google

Voice™ command capabilities, we've developed a way to let you articulate your desires, even if that's just finding the closest burger stand or the best hotel.¹ MMI® navigation plus with Audi connect helps integrate networking capabilities on the go, along with Google Earth™ with 3D satellite imagery, to help you avoid traffic (and possibly saying things you might regret)² Audi connect also provides fast data transfer speeds and Wi-Fi® connectivity for up to eight passenger devices to help you stay informed. It offers a full suite of services and interactivity, and, yes, even the closest Szechuan restaurant, which you can find by using its Google™ Local Search capabilities. Best of all, you don't even have to say "Thank you," even if we appreciate it when you do.

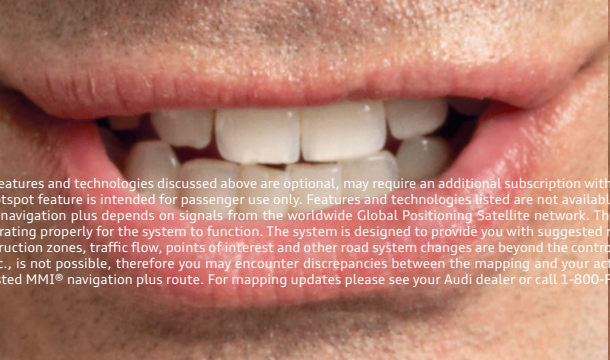
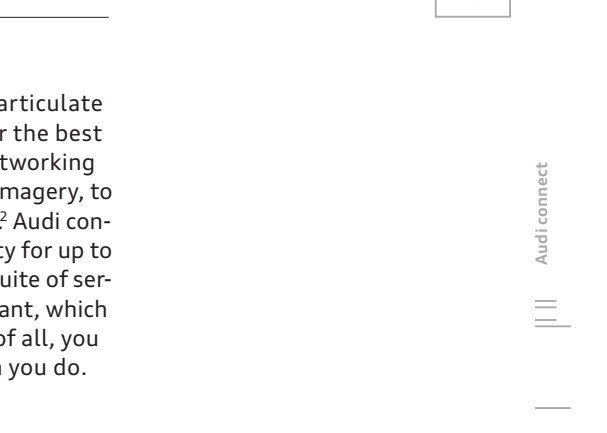
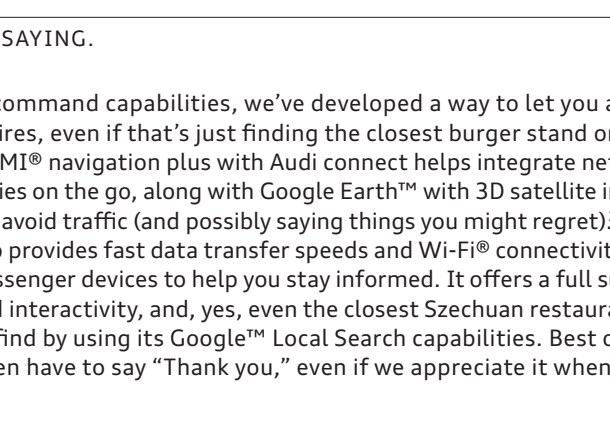
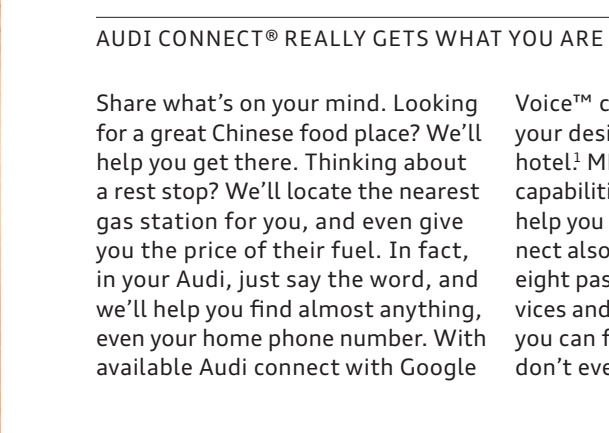

1. Always pay careful attention to the road, and do not drive while distracted. The features and technologies discussed above are optional, may require an additional subscription with separate terms and conditions, and should be used only when it is safe and appropriate. The Wi-Fi® hotspot feature is intended for passenger use only. Features and technologies listed are not available on all models. The voice control feature is not available on Cabriolet or Roadstar models. 2. MMI® navigation plus depends on signals from the worldwide Global Positioning Satellite network. The vehicle's electrical system and existing wireless and satellite technologies must be available and operating properly for the system to function. The system is designed to provide you with suggested routes in locating addresses, destinations and other points of interest. Changes in street names, construction zones, traffic flow, points of interest and other road system changes are beyond the control of Audi of America, Inc. Complete detailed mapping of lanes, roads, streets, toll roads, highways, etc., is not possible, therefore you may encounter discrepancies between the mapping and your actual location. Please rely on your individual judgment in determining whether or not to follow a suggested MMI® navigation plus route. For mapping updates please see your Audi dealer or call 1-800-FOR-AUDI for details. Features and technologies listed are not available on all models.



Hey, bright eyes.



DESIGNING A WINDOW TO OUR SOUL.

Even in the dark, you know when you're staring at an Audi. In fact, it might just be love at first sight. That's because, instead of cursing the darkness, we celebrate the light. Available full LED headlights stand out from the rest: their color inten-

sity is engineered to be reminiscent of daylight. But while we illuminate the night, we don't forget the day—so we made our LED daytime running lights to look even more dramatic. Now featuring a sleek diode design that gives us the freedom to elegantly reshape our signature style, Audi LED lighting is once again ours. It is an efficient, beautiful way to help you see and be seen from dusk to dawn and back again. Look deep into our eyes, and you might just see the soul of a company.



How we know exactly what you feel.

CLEAN, BEAUTIFUL DESIGN COMES FROM DEDICATED CRAFTSMEN UNAFRAID OF GETTING THEIR HANDS DIRTY.

Our hands give you shade and sanctuary. Our hands give you comfort and control. You might not sense our hands nearby, but our hands know exactly what you feel. That's because we've been there. After all, our hands crafted a customized world that's dedicated to control, comfort and entertainment. We're talking,

of course, about the cabin of your Audi vehicle. Optimized luxury, designed by committed craftsmen who had you in mind when they chose the leather seating surfaces, created the contoured seats or provided the refinement of ergonomic design and an available more intuitive MMI® system. There are small touches that help simplify the overall design, and there are large statements to help you feel at ease. It is your Audi interior, shaped by the kind of people who know you want to experience luxury firsthand.



As you can see, our design will help channel water away from the mirror, allowing you a clearer view of what's behind you.

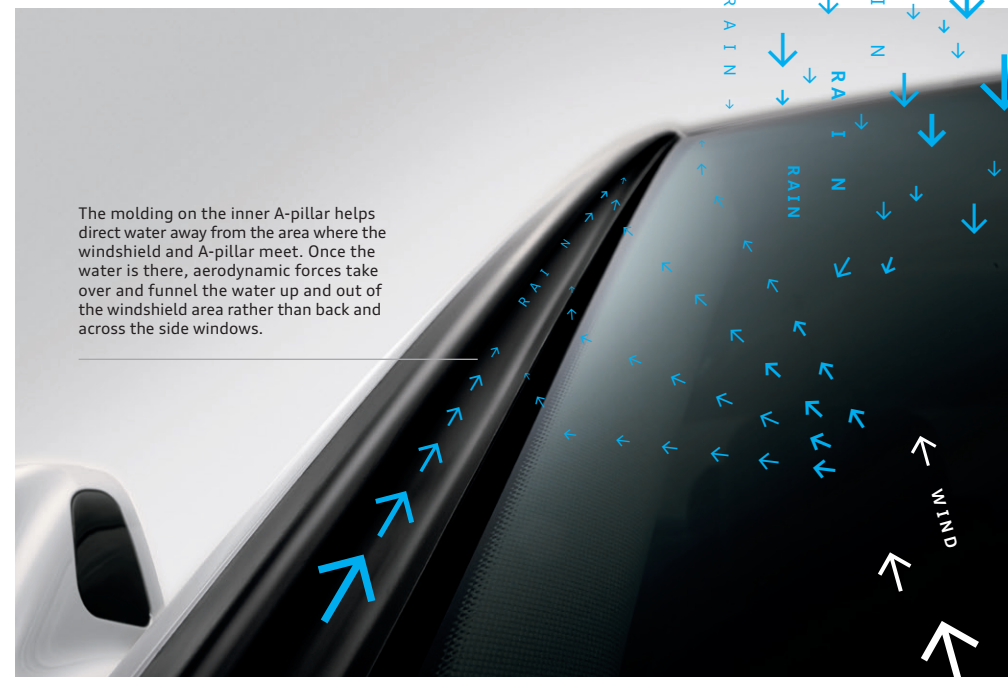

The molding on the inner A-pillar helps direct water away from the area where the windshield and A-pillar meet. Once the water is there, aerodynamic forces take over and funnel the water up and out of the windshield area rather than back and across the side windows.

You have to weather adversity to know things like this.

WHAT YOU DON'T KNOW MIGHT HELP YOU.

Think of it this way—if it rains, would you notice a dry side view mirror? Maybe not, but compared to one with beads of rain on it and distorted reflections, you would. It's a little thing, perhaps, but these little things are part of our deep obsession with crafting a premium driving experience.

We design our exterior side mirrors with small sills to channel water along their upper edge, helping leave your view unobstructed. We also design our windshield moldings with channels that allow rain water to efficiently run off instead of returning to the windshield wiper path. These are small touches, thought of by engineers and crafted by designers who don't necessarily call attention to their skills. Instead, these details reflect a commitment to quality that you might never notice—until a moment of bad weather or adversity, when you might. But don't worry. We don't mind if you don't notice us, now and then.



Either think about the future, or make history.



e-tron®



SUPREMELY PRACTICAL LUXURY WITH A SUNNY KIND OF ENERGY.

Talking about a better future is easy. After all, how can you be held accountable for something that never arrives? But if you really want to affect it, to make history, you have to do more than talk. Enter e-tron®. It's not the first plug-in electric hybrid to the market, but we are making it the most forward-thinking Audi ever produced. For example, we will be including a

level 2 charger with our A3 Sportback e-tron PHEV for owners who want to drive on electricity as much as possible. We also plan to offer unique sustainable energy offerings like an available solar powered connection to your charger. It's not just practical, it's premium too, in style, in performance and in fit and finish, like any other Audi vehicle. The A3 e-tron will be able to take on the average daily commute on electric-only before the efficient 1.4 TFSI® gas engine is needed.¹ But more than that, it will be Audi making smart technology smarter, with innovative kinetic-energy-harnessing when you brake, and better performing than what came before it. With the Audi e-tron vehicles, we're saying the future is now.

¹ Preliminary manufacturer's estimates.



The little things that add up

01 Audi connect

Our Google™ powered information system.¹

02 Audi Care

Available convenient service option.

03 MMI updates

MMI navigation and other software updates.¹

04 SiriusXM® Satellite Radio

Endlessly diverse music channels with a complimentary trial offer.¹

05 Audi exclusive

Available customizable exterior and interior color and material options.

SENSE OF HUMOR

RESOURCEFUL

ROMANTIC

SENSE OF STYLE

GENEROUS

LOVING



to a long-term love.

MOVING FROM LUST TO APPRECIATION TAKES A DEEPER UNDERSTANDING.

When you are attracted to something, the effects are immediate, the domination, total. For a relationship to last, though, it must move beyond that passionate initial phase. It's what comes next that turns a bright flame into an eternal torch. That's why Audi doesn't simply design premium vehicles for the

short-term, but offers an entire experience that we hope lasts a lifetime. Do you want to customize your Audi? We offer Audi exclusive materials and colors. Do you want care-free service options? Audi Care is available. MMI® updates, trial offers for Audi connect®, a full suite of available Audi driver assistance technologies—these might not be the reasons why you fell in love with an Audi, but they are, perhaps, the things that help keep the heart fires stoked.¹

¹ Optional features and technologies listed are not available on all models. See Infotainment/Technology section of the Featured Content page for important information regarding MMI® navigation plus and required SiriusXM® subscriptions.

FIND THE
CITY STREETS
ROAD IN THE ALL-
POWERED FOR
MOVER, STYLED
THE SHAKER, IT
ON THE

TRUTH IN
OR ON THE OPEN
NEW Q3.
THE
FOR
IS ENGINEERING
HUMAN SCALE.

Inspirations that build an icon.

The alchemy needed to build an automotive icon is elusive. Sure, it's found, partly, on an assembly line, with committed artisans taking pride in every stitch they oversee. It's also on a drafting board, sketched by visionaries looking to further expand what we look for in automotive design lines. But it's also in the countless inspirations, ones little and large, that not only capture a bold thought or striking idea, but execute them. Examples of these can be found in the foundational stories we tell about our company and our vehicles. These stories show how an abstract idea can turn into a powerful, sculpted machine, and then how that machine can help forge an iconic reputation for a brand. Out of the inspirations we **find** in engineering, art and the large world of ideas, we have created a fearless, iconic company of substance and luxury: Audi.

A standout in the city square.

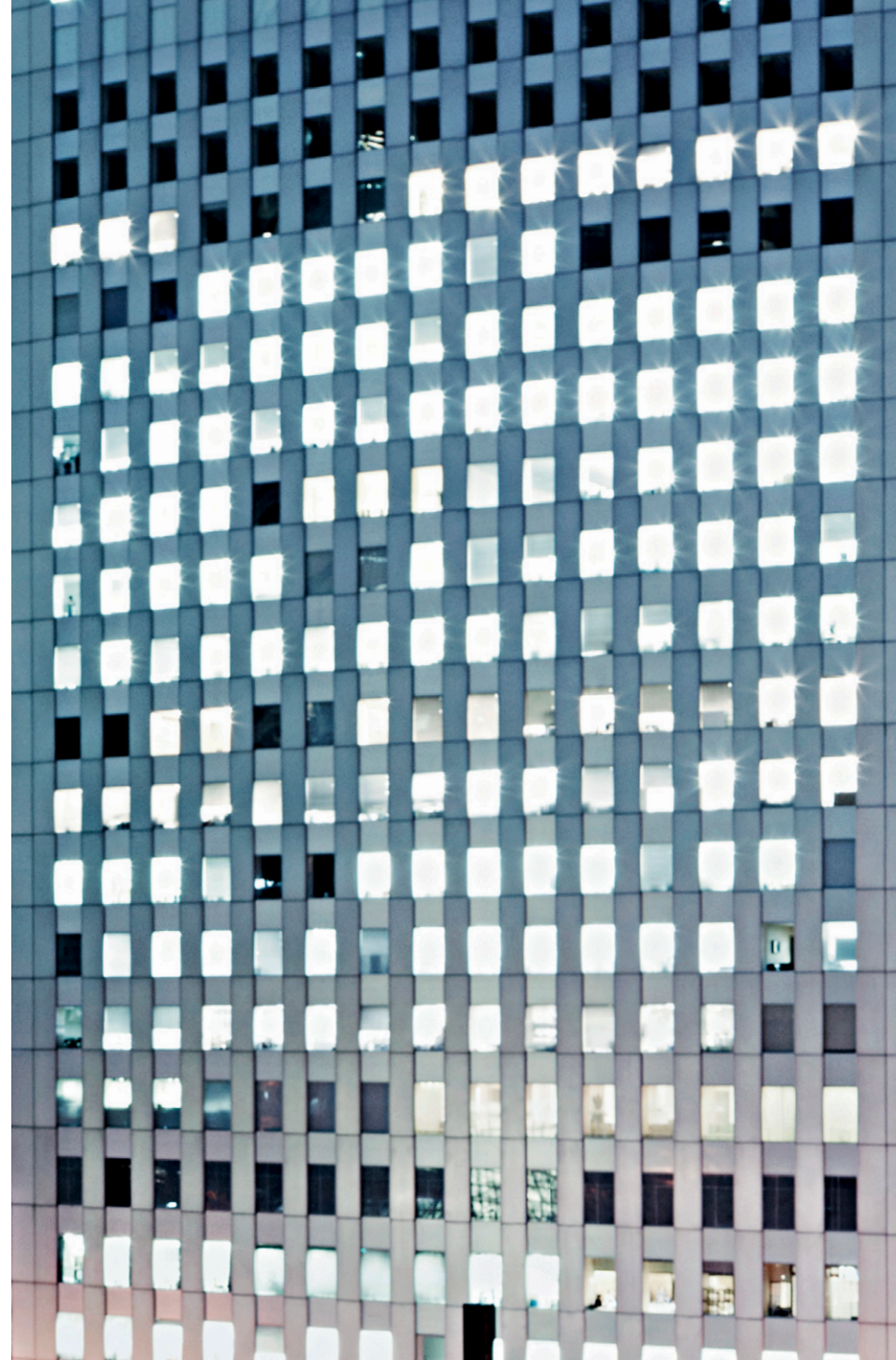

With backdrops ranging from the ultramodern downtown loft or the work-in-progress brownstone; the city moves to its own beat. The sound of cabbies hustling for their next fare and the wail of distant police sirens accompany every step. Take in the familiar scents of hotdogs and churros wafting in the air while surveying, at every intersection, the flashing neon lights and sights that can often border on the bizarre. Yes, this is the city, in all its splendor. But there's more. It's a bustling ecosystem comprised of art scenes and beat cafés, sporting venues and concert halls, and this is a vehicle that stands out from the urban fabric, just as you will. Introducing the all-new Audi Q3.

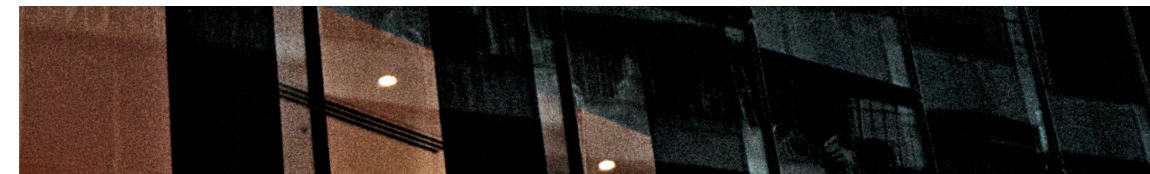



Enlighten

A new light on illumination just happened to be a design boon.

Cross over into the city necessity vehicle.

You won't mean to turn heads as you crawl through busy intersections, making your way from uptown to downtown, just consider it collateral damage. The Audi Q3 is designed to match the pace of the city, and that's why movement is engineered into its design. Its modernity is displayed in its sloping roofline, giving the Q3 its coupe-like look and feel. The Singleframe® grille and xenon plus headlights with LED daytime running lights radiate a city-like determination, illuminated for improved visibility to cyclists and other motorists while getting you where you need to be with style. With intention, we blend design and practicality, helping ensure the Q3 is the perfect companion for city life. We've simply delivered both in a single, stylized package suited equally for the symphony or the farmers market.

Short front hood to maximize interior space.

Oversized side mirrors for a better view.

Coupe-like roofline and wrap-around tailgate.

Aerodynamic underbody



Design

We do not follow design trends. We set them.

It's OK to fall for these lines.

Our mission wasn't to contribute to the architecture of the city, but the lines we implemented in the design of the Audi Q3 delivered. Complementary to your style, your surroundings and your lifestyle, the lines on the Audi Q3 were crafted to lure you in, no matter what your perspective. Sized for the city, but still featuring a higher seating position for improved driver visibility, the Q3 is the only accompaniment you'll need to paint the town an assortment of available colors. One can definitely say that it's intentionally slicker for the city.



Craftsmanship

We've ensured that every stitch represents the detail that we put into every aspect of an Audi vehicle.



Decorative inlays

Beautifully crafted aluminum or wood inlays add a warm and sophisticated touch to an already regal interior. And with two inlays available, you can be sure your style will match that of the city.

Urban engagement center.

The city is a mix of new and old thriving together, and, to an extent, it's not unlike the interior of the Audi Q3. The Q3 is loaded with available technologies like MMI® navigation plus and award-winning Audi connect® and subtle touches like ambient lighting, developed specifically for the modern world.^{1,2} But it wouldn't be an Audi without the quality craftsmanship and refined materials we've relied upon for decades. Driver-centric controls are thoughtfully placed for easy engagement. Leather seating surfaces and a leather-wrapped steering wheel ensure that every encounter is a luxurious one. So even when you surround yourself with the modernity of the technological world, there's a little bit of bygone thinking at work too.

1- See Infotainment/Technology section of the Featured Content page for important information regarding MMI® navigation plus. 2- Always pay careful attention to the road, and do not drive while distracted. The features and technologies discussed above are optional, may require an additional subscription with separate terms and conditions, and should be used only when it is safe and appropriate. The Wi-Fi® hotspot feature is intended for passenger use only.



Power tailgate

Made from aluminum, the available power tailgate with its wraparound design is an unmistakable styling element on the Audi Q3 that emphasizes the vehicle's width and facilitates convenient loading and unloading of cargo.

Cargo space

You can put a lot of good things into this small package. With 48.2 cu ft of storage space with the rear seat folded flat, the Q3 can answer the call of the wild as well as tame the urban jungle. Whether you're stocking up at the store, or getting away for the weekend, the Q3 is engineered to adapt to you.

Split folding rear seatbacks

The 60/40 split folding rear seatback makes adventure possible, giving you the flexibility to house a variety of gear or equipment in your Q3.



Here's where traffic gets a time out.

You're perfectly adapted as a denizen of the city, but there are times it can become overwhelming. The happenings of a vibrant city can take their toll, so we made sure that the cabin of the Audi Q3 helps keep the noise out. It's our way of letting you appreciate city life and get away from it at the same time. With the comfort of our supple leather seating surfaces, twelve-way power front seats (including four-way power lumbar support), we've engineered a place that is a little closer to a perfect sanctuary. And if you need a greater escape, the Q3 is capable of taking you on a variety of excursions; with the 60/40 split folding rear seats folded flat, you'll be able to slide a generous amount of cargo over the available stainless steel trunk sill.





City space. City's pace.

Space is at a premium in the city, the pace is bustling, so we've crafted the kind of contemplative interior that is both expansive and comfortable. The large panoramic sunroof we engineered into the Audi Q3 is dramatic in its openness, and provides a stellar perspective of the skyline above you. So whether you're taking in the city air through the panoramic sunroof or relying on the dual-zone automatic climate control that comes standard, the Q3 gives you the metropolis in style, no matter what your point of view.



Panoramic sunroof

The standard panoramic sunroof offers both the front and rear passengers an unobstructed view overhead while flooding the cabin with natural light. And when you decide you need to say goodbye to the sun, a power sunshade is there to make it an easy task.



Climate control

Personal attention is paramount in the Q3. With the standard dual-zone automatic climate control, the driver and front passenger have the ability to dial in their ideal temperatures.

A gripping story of twists and turns.

City streets can be as surprising as the stories they tell. Debris, broken glass, construction zones, gravel and neglected surfaces all make traction difficult. That's why we developed the available quattro® all-wheel drive system. Leading us heroically to countless wins on the rally circuit, quattro® has also helped lead the way to wins on paved tracks like Le Mans. Much more than a tool for handling inclement weather, it also helps improve vehicle performance in city driving. The quattro® system ensures that, as the city saga unfolds, you'll be a step ahead of the plot.¹

quattro

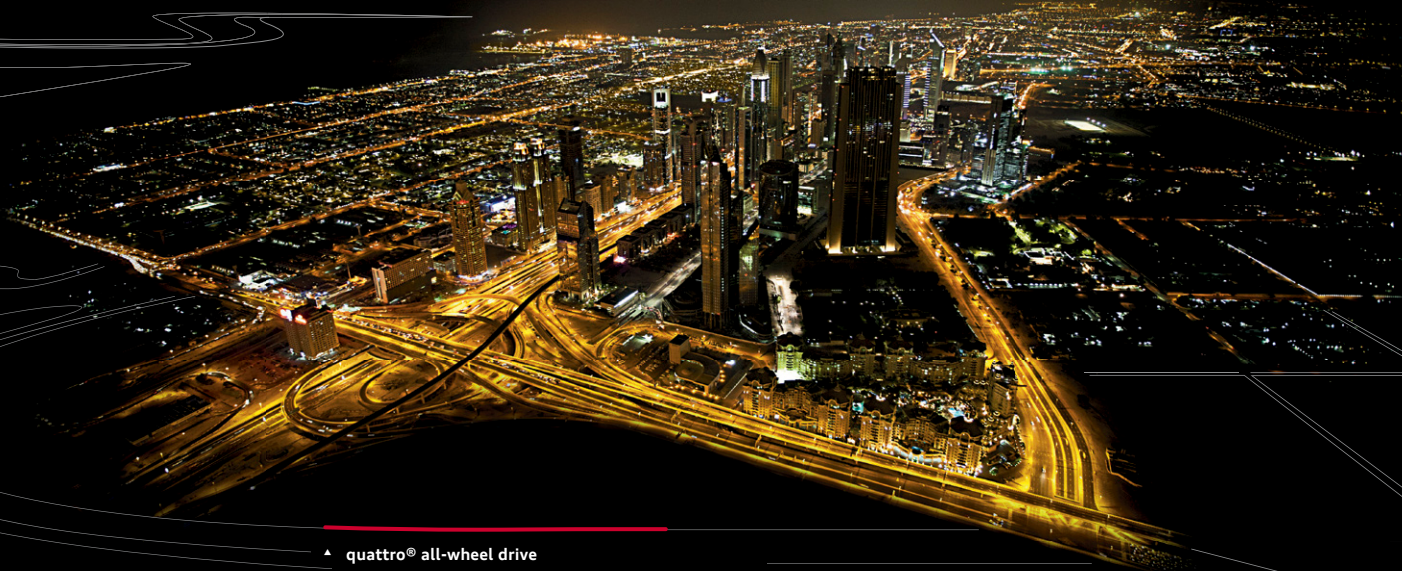

▲ quattro® all-wheel drive

With available quattro®, the Q3 can “read” the road, sensing changes in the surface beneath the wheels and adjusting their grip accordingly. So when driving conditions become more demanding, quattro® adapts to deliver precisely distributed power to where it's needed to handle the change in the terrain.

◀ Hydraulic multiplate clutch

To help give you optimal traction in practically every situation, the available quattro® system's hydraulic multiplate clutch can distribute power to the front and rear axles individually. During normal driving conditions, it directs a majority of the available engine torque to the front axle, but in extreme circumstances, it can transfer up to 100 percent of the torque to one of the two axles.

◀ All-around confidence

Just like life, the road can throw you a curve. So throw one right back with the superior grip and control of available quattro® all-wheel drive. It helps provide the legendary performance and confidence you would expect from Audi, no matter if you're commuting in the city or crisscrossing the country. This is advanced engineering you can live with.

¹ When driving during cold, rainy, snowy or icy weather conditions, ensure that your vehicle is equipped with appropriate all-season or winter tires. Even with appropriate tires, you must always drive in a manner appropriate for the weather, visibility and road conditions.

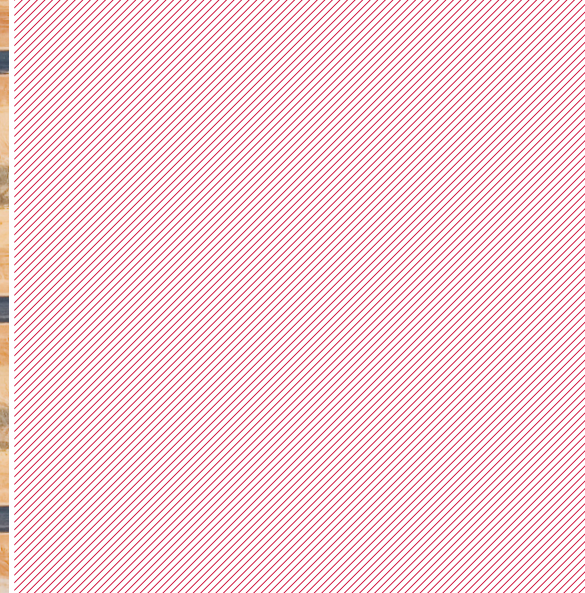
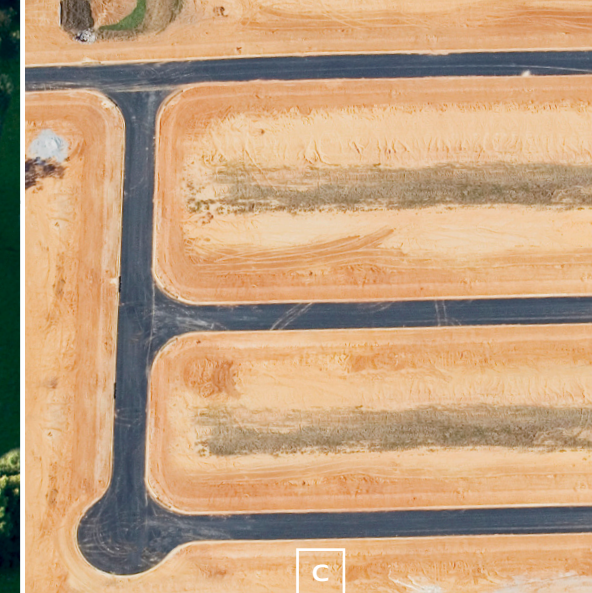
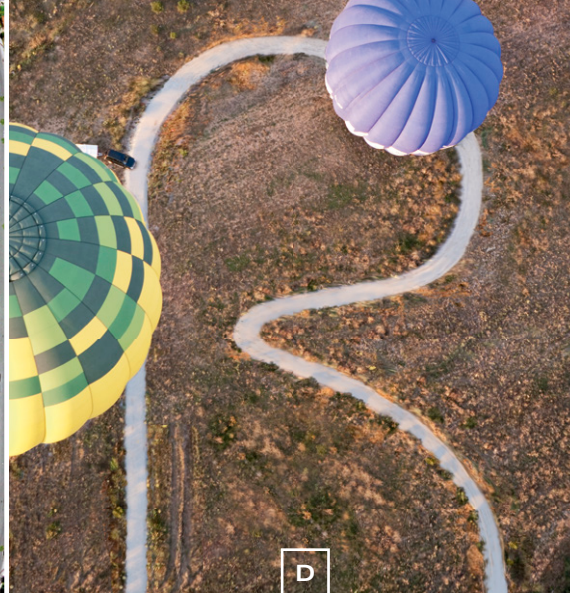

C Comfort mode
Perfect for those long highway stretches, this setting adds optimized steering and throttle tip-in to help provide a more relaxed drive.

D Dynamic mode
Tighter steering and a more responsive throttle give this setting an aggressive feel and focused performance.

A Auto mode
The best of both worlds, dialed to automatically adjust settings for a seamless combination of comfort and responsiveness based on your driving style and road conditions.

At Audi, we believe you should be the ultimate master of your road-going domain. That's why we created the available Audi drive select system. It gives you the ability to adjust the vehicle's steering and throttle response with the utmost of ease. And with three modes to choose from, when almost any kind of road comes into question, Audi drive select will let you answer.

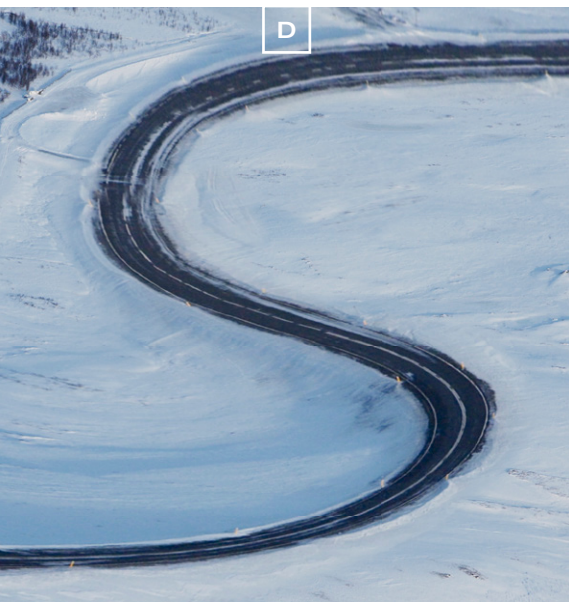

When you drive the parkway and ditch the highway.

Producing more power from smaller engines has been a “right-sizing” philosophy of ours for quite some time, something you’ll soon realize when you motor through city streets. Moving through crosstown traffic requires the perfect combination of power and performance, so the Audi Q3 is aptly outfitted with a 2.0-liter TFSI® engine that delivers 200 hp and 207 lb-ft of torque. This ensures that, while your commute may consist of short bursts, your sprints will be both exciting and dynamic.

Induction-technology turbocharger

Compressing the airflow to the engine allows more air into the cylinder and, ultimately, more power from each combustion cycle, helping to improve the engine’s power-to-displacement ratio.



Performance

The adage “good things come in small packages” has never been more true.

2.0 TFSI four-cylinder

This 2.0-liter turbocharged DOHC engine produces 200 horsepower and 207 lb-ft of torque, and combines FSI® direct injection and turbocharging for great power and overall performance.

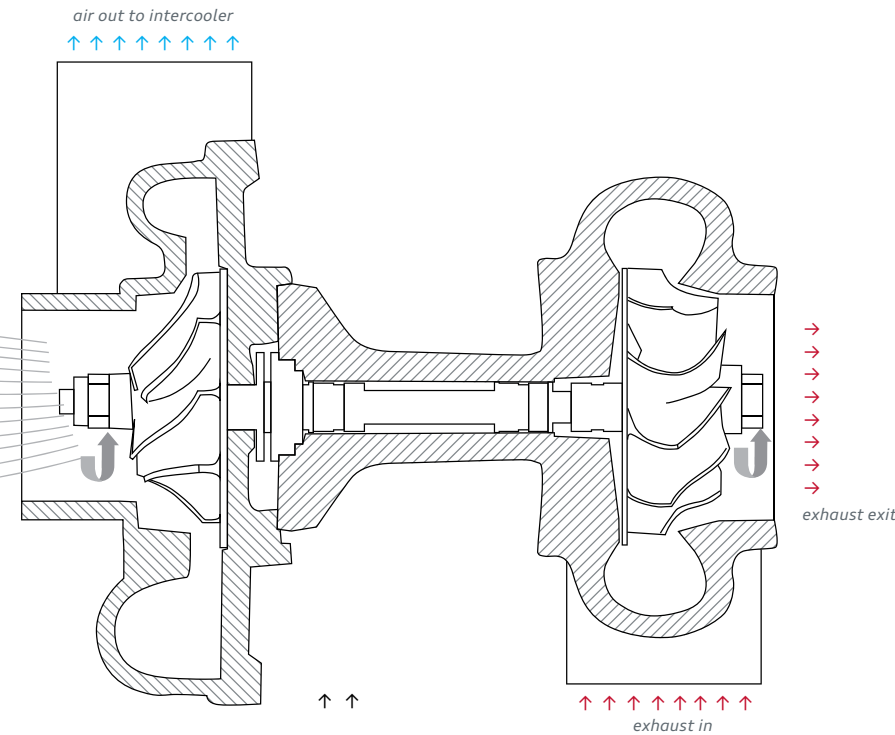

Exhaust gas intake

Exhaust from the engine spins the turbine that is connected by a shaft to a compressor that pressurizes air. The compressor forces this pressurized air into the cylinders at boosted pressures, thus producing more power from a smaller displacement engine.

Built to answer a red-light, green-light lifestyle.

Stop-and-go driving isn’t the best way to get around, but it’s an unavoidable aspect of life in the city. To combat this inefficiency, the six-speed Tiptronic® automatic transmission is engineered to shift smoothly, and has wide gear ratios that help maximize power and acceleration and minimize waste. It’s just another way we utilize smart technologies to give specific personalities to the drivetrains of each vehicle.

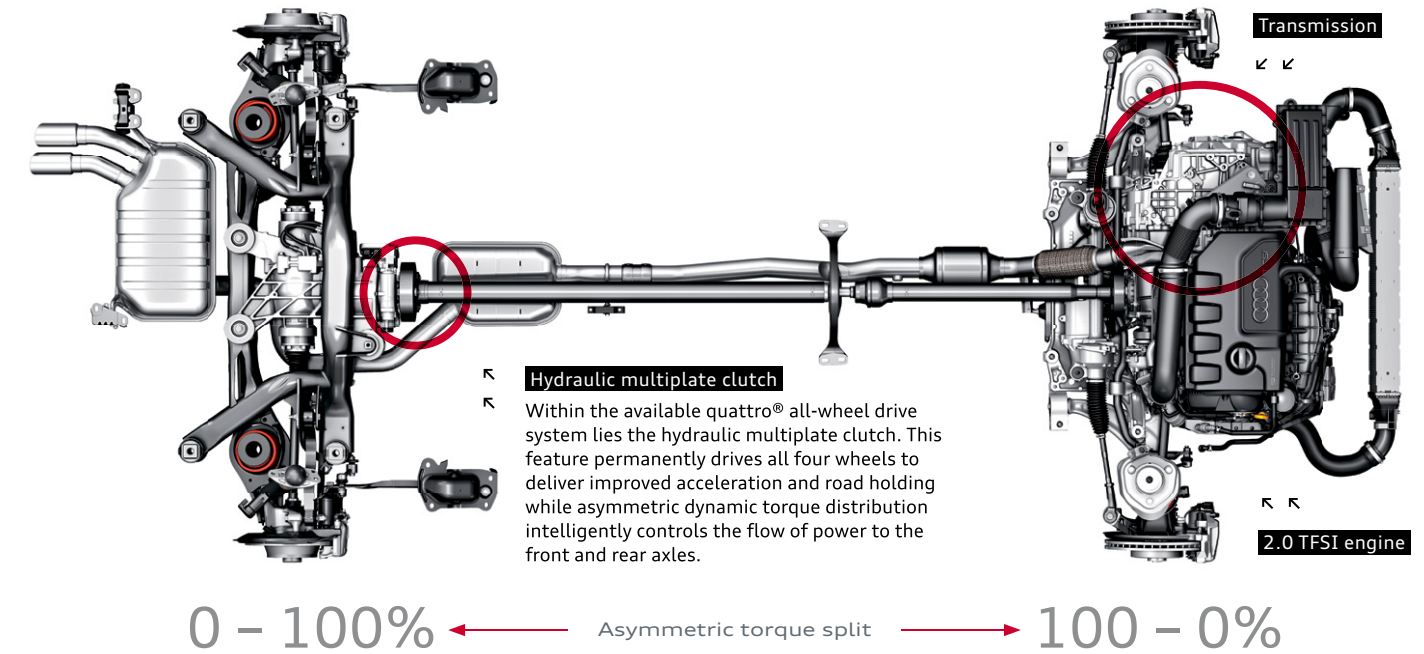

Six-speed Tiptronic® automatic transmission

As the perfect compromise between a dedicated manual and an automatic gearbox, the six-speed Tiptronic® automatic transmission in the Audi Q3 offers six optimized, carefully chosen gear ratios. Selected automatically or via its console-mounted shifter or steering wheel with available shift paddles, precise shifts are delivered without sacrificing the smooth action of the Tiptronic® automatic.



Driver Assistance

We're solving problems before you even know you have them.

A little insight into the things you cannot see.

It always happens: the light has turned green, but there are still shuffling stragglers in the crosswalk. It's important to be alert, so we've equipped the Audi Q3 with a number of features to help you observe pedestrians and surrounding vehicles. Large, available power-folding side mirrors help keep you aware of your surroundings, and available Audi side assist helps with lane changes and is perfectly suited for the hustle and bustle of town. And since parking is always at a premium, the available parking system plus with rear view camera can help you maneuver into tight parking spots with ease. With all of this wrapped into a city-ready crossover, you'll find the Q3 is eager to help you get around town.

Power-folding mirrors

In the city, parking spaces are tight. Fortunately, the Audi Q3 was engineered to seamlessly adapt. When you find the perfect spot, available power-folding mirrors will help ensure that no damage will occur from bicyclists and passersby.

Parking system plus with rear view camera

Helping to make parking a significantly easier task, the available parking system plus features front and rear acoustic parking sensors. For added benefit, the rear view camera offers selectable guidelines for parking in parallel or perpendicular spaces.

Hill descent assist

When traveling at lower speeds on a downslope, the driver can engage hill descent assist via a button located on the center console. Once selected, the system detects loss of traction due to slippery surfaces or wheels leaving the ground, and automatically responds by activating the brakes, thus helping to maintain a constant speed.

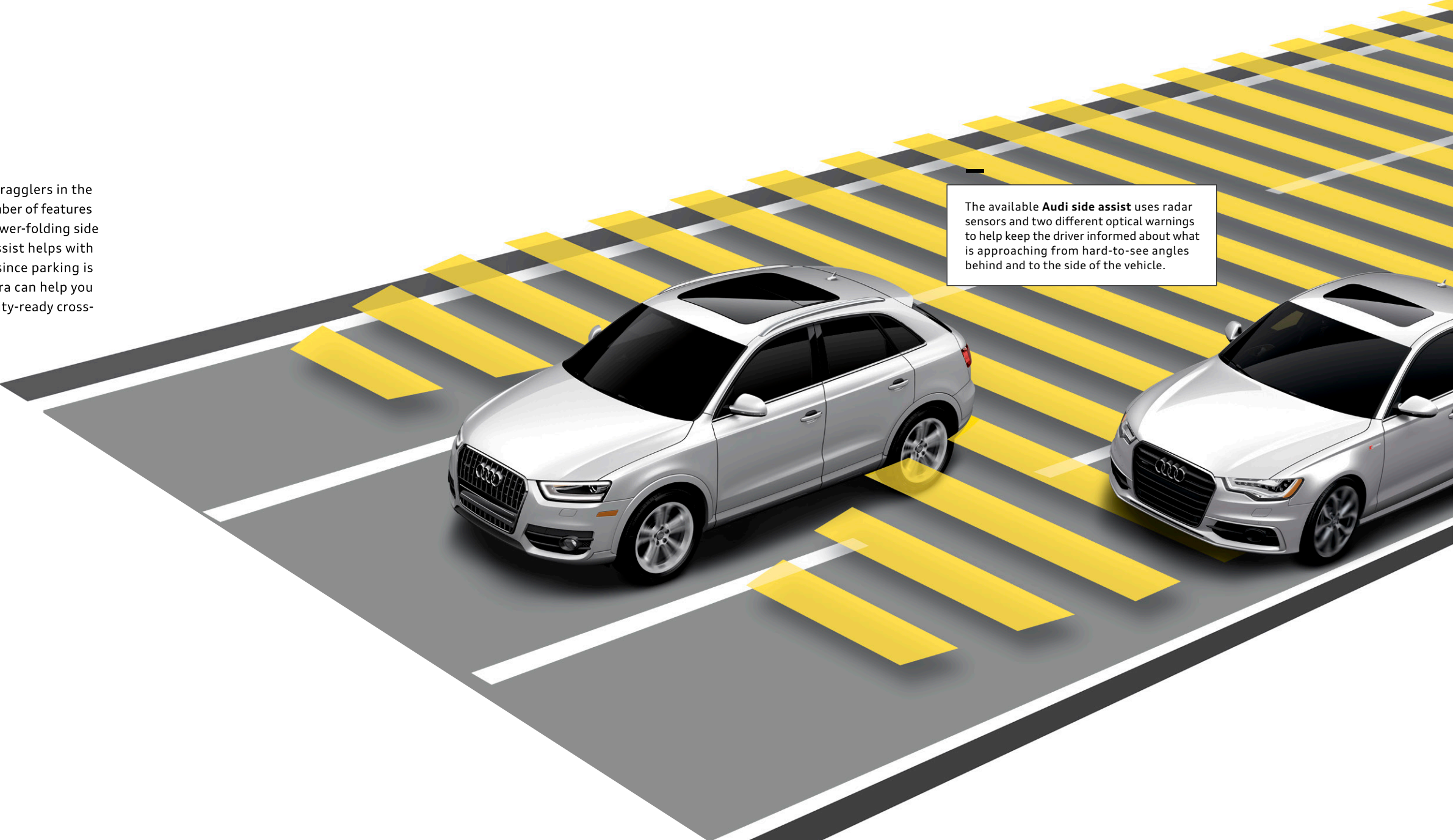

The available **Audi side assist** uses radar sensors and two different optical warnings to help keep the driver informed about what is approaching from hard-to-see angles behind and to the side of the vehicle.

Tough enough for the big, bad city.

Living, working and driving in the big city require a tough skin. Six standard airbags can be found throughout the interior.¹ Lightweight and extremely strong aluminum and reinforced steel encase you and your passengers, and crumple zones are specifically engineered to help absorb impact, lessening the shock to everyone inside.



Safety

Working to spread a “bend, don’t break” philosophy.

Six standard airbags

With six standard airbags, including front-impact, Sideguard[®] curtain, and thorax side airbags for both driver and front passenger, you’ll feel practically surrounded.¹ And that’s a good thing.

ESC and ABS

Computerized technology that works in perfect sync with the Anti-lock Brake System (ABS), Electronic Stability Control (ESC) helps minimize any loss of stability, applying brake pressure to individual wheels and reducing throttle input to help counter oversteer or understeer when the vehicle needs it.

¹ Airbags are supplemental restraints only and will not deploy in all crash circumstances. Always use safety belts and seat children only in the rear, using restraint systems appropriate for their size and age.

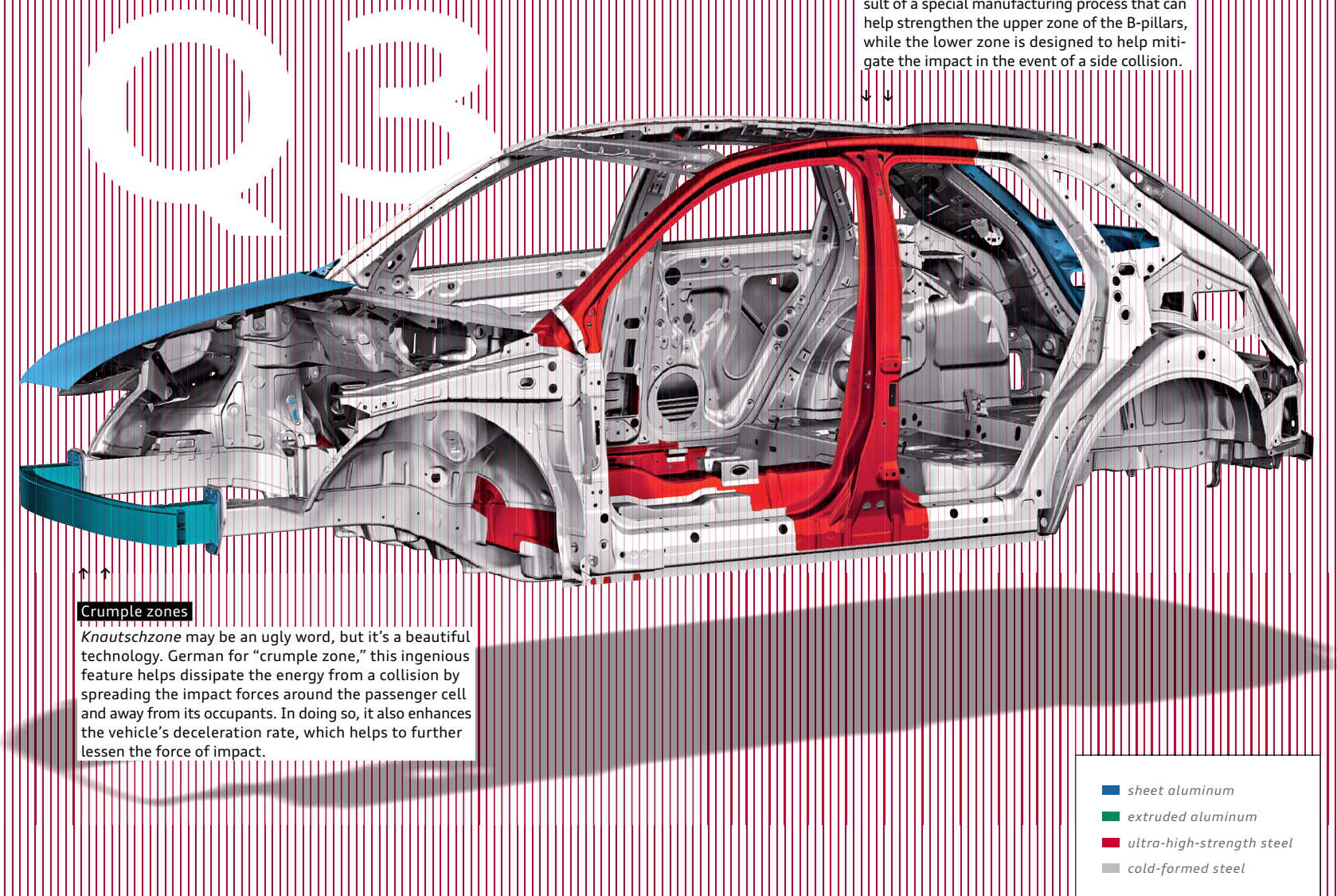

Q R

Tailor-made blanks

Developed to make the best possible use of the body’s potential, tailor-made blanks are the result of a special manufacturing process that can help strengthen the upper zone of the B-pillars, while the lower zone is designed to help mitigate the impact in the event of a side collision.



Crumple zones

Knautschzone may be an ugly word, but it’s a beautiful technology. German for “crumple zone,” this ingenious feature helps dissipate the energy from a collision by spreading the impact forces around the passenger cell and away from its occupants. In doing so, it also enhances the vehicle’s deceleration rate, which helps to further lessen the force of impact.

- sheet aluminum
- extruded aluminum
- ultra-high-strength steel
- cold-formed steel

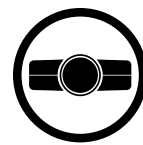

MMI System

Putting your needs front and center.

Become your own city planner.

As cities modernize, they rise up higher and expand outward. New corridors emerge, connecting existing sights with the new ones. Keeping traffic under control becomes an around-the-clock occupation. So while congestion is common in and around town, we've decided to help you minimize the time you spend behind the wheel.



Function buttons

Helping you navigate through the MMI® system with ease are four well-placed function buttons. Each button correlates to a command at the corner of the screen and, when pressed, takes you to your desired selection.



SiriusXM® Satellite Radio

Go ahead. Crisscross the country. We assure you, you'll never run out of entertainment options, with over 150 channels of music, talk, sports and news.¹

Audi media

Now you're in control. The standard Audi music interface helps give you seamless iPod® integration. Your compatible iPod® device can be controlled through the audio system and steering controls, and with SD card slots for your MP3 music, your entertainment options just keep getting better.

MMI navigation plus

Count on the available advanced navigation system to home in on your destination with stunning precision while putting a little more depth in your journey with help from the available Audi connect®^{1,2}

BLUETOOTH® wireless technology

Unlock your compatible mobile phone's potential through the MMI system. Simply pair them up and start enjoying near complete control at the touch of a button.

¹ See Infotainment/Technology section of the Featured Content page for important information regarding MMI® navigation plus and required SiriusXM® subscriptions. ² Always pay careful attention to the road, and do not drive while distracted. The features and technologies discussed above are optional, may require an additional subscription with separate terms and conditions, and should be used only when it is safe and appropriate. The Wi-Fi® hotspot feature is intended for passenger use only.

Find the shortest distance between points A through Z.

Chart your journey before you've even left the house, thanks to available Audi connect® and your myAudi account.¹ Audi connect is your onboard personal assistant, traffic helicopter, meteorologist, navigator and much more. And with the benefits of Google Voice™ Local Search, Audi connect can help you find the meal you're in the mood for or points of interest you want to visit, and help reroute you in the event that you find yourself in some unexpected traffic. So no matter how many stops you have to make on your next outing, be sure you don't do it alone.

POI

Point-of-interest

The point-of-interest search with voice control means that the digital world is with you on every journey.¹

myAudi

myAudi features

Plan travel from your personal computer. Send your desired destinations to your vehicle ahead of time and access your route from your vehicle later.¹

NEWS

News feeds

Stay on top of the news by having headlines and stories delivered right to your MMI® display.¹

Wi-Fi

Mobile Wi-Fi® hotspot

Provides high-speed connectivity for up to eight passenger devices through an onboard wireless hub.¹



SiriusXM® Traffic

Get traffic information overlaid onto available 3D satellite imagery to visualize a true aerial view of your route, and let the MMI navigation plus system reconfigure your route to help avoid traffic.^{1,2}



Google Earth™ with 3D satellite imagery

With Google Earth™ integration, you'll enjoy 3D satellite imagery, including Google Maps Street View, displayed right on the MMI display.¹



Weather information

Current local conditions and forecasts for your destination can help you prepare for your trip.¹



Google Voice™ Local Search

Simply tell your Audi what you are in the mood for, then let the cloud-processing power of Google™ speech recognition interpret your request and bring up a list of destinations in the area of your choice.¹



Google Maps Street View

With Google Maps Street View, your vehicle can show you a driver's-eye view of your destination right before you arrive so it's easy to recognize.¹



Parking information

Search for parking in your area of interest, check space availability and set your selection as a destination to help navigate directly to the garage entrance.^{1,3}



City events

Get information about current events, exciting locations and places of interest at your travel destination, current location or other chosen location instantly.¹



Travel info

Discover local landmarks in your area of interest, set them as your destinations, and let your vehicle lead the way as you explore the world around you.¹

¹ Always pay careful attention to the road, and do not drive while distracted. The features and technologies discussed above are optional, may require an additional subscription with separate terms and conditions, and should be used only when it is safe and appropriate. The Wi-Fi® hotspot feature is intended for passenger use only. ² See Infotainment/Technology section of the Featured Content page for important information regarding MMI® navigation plus and required SiriusXM® subscriptions. ³ Parking information is not available everywhere and requires participation by parking provider.



Sound

Audi is Latin for "listen," so you know we take sound very seriously.

Your city. Block by block, beat by beat.

Tune in and turn it up. We offer an available premium BOSE® Surround Sound System in the Audi Q3, tuned to help ensure that every note matches the energy of the town. 465 watts power 14 speakers purposely placed to ensure that your favorite songs come through with the crispness and clarity the artist intended. And while we ensure that the sound within the cabin is always premium, the aerodynamic design of the Q3 is specifically engineered to help reduce noise from outside the cabin. You might say that we're in the business of sound engineering too.

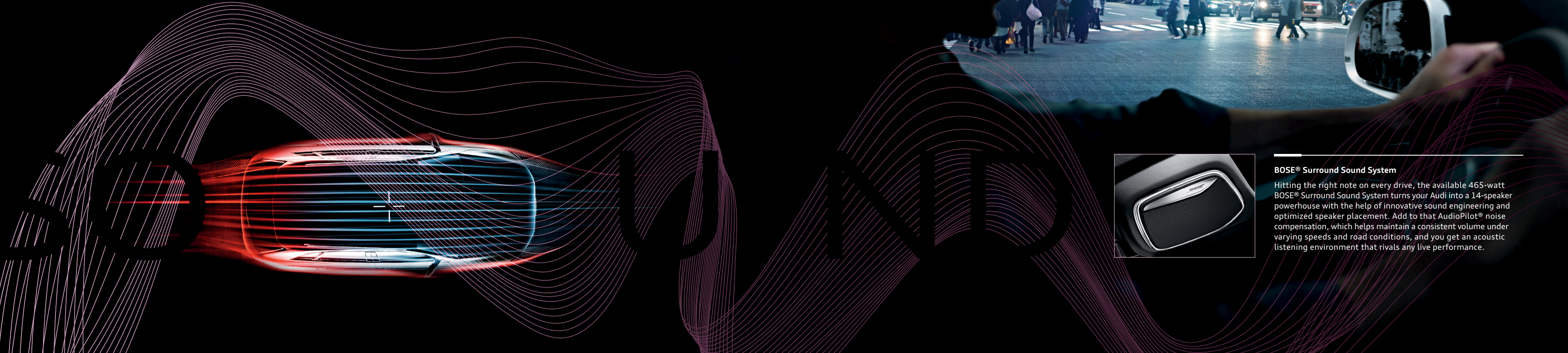

BOSE® Surround Sound System

Hitting the right note on every drive, the available 465-watt BOSE® Surround Sound System turns your Audi into a 14-speaker powerhouse with the help of innovative sound engineering and optimized speaker placement. Add to that AudioPilot® noise compensation, which helps maintain a consistent volume under varying speeds and road conditions, and you get an acoustic listening environment that rivals any live performance.



LED taillights

LEDs are among the most luminous taillights available. And, like Audi vehicles, they are efficient, technologically advanced and long-lasting.

On notice about being noticed.

You didn't mean to make a grand entrance, but you can rely on making a graceful exit. So make small talk as you wait for the valet to bring around your Audi Q3, and remember, people will take notice. Just for fun, look back before you pull away to see wide eyes illuminated by our signature LED taillights. Don't be fooled by the red glow—deep down your onlookers are glowing green.



Premium Plus

Q3 Premium Plus featured highlights

- ▶ Singleframe® grille
- ▶ Xenon plus headlights with LED daytime running lights
- ▶ Automatic headlights
- ▶ Front and rear fog lights
- ▶ LED taillights
- ▶ Power-adjustable heated exterior side mirrors
- ▶ LED turn indicator lights integrated into the exterior side mirrors
- ▶ Rear privacy glass
- ▶ Aluminum roof rails
- ▶ Aluminum trim around exterior windows
- ▶ Dual-zone automatic climate control
- ▶ Three-spoke multifunction leather-wrapped steering wheel
- ▶ Auto-dimming interior rear view mirror with digital compass
- ▶ Leather-wrapped shift knob
- ▶ Folding and sliding front center armrest with height adjustment
- ▶ Ambient LED interior lighting
- ▶ Panoramic sunroof
- ▶ Leather seating surfaces
- ▶ Twelve-way power front seats, including four-way power lumbar adjustment
- ▶ Heated front seats
- ▶ 60/40 split-folding rear seat with pass-through armrest and cupholders
- ▶ Driver information system
- ▶ Audi concert radio with ten speakers and MP3 playback capability
- ▶ HD Radio™ Technology
- ▶ SiriusXM® Satellite Radio with 90-day trial subscription¹
- ▶ Audi music interface with iPod® integration
- ▶ BLUETOOTH® streaming audio²
- ▶ BLUETOOTH® wireless technology preparation for mobile phone²
- ▶ Audi advanced key—keyless start, stop and entry (front doors and tailgate)³
- ▶ Cruise control with coast, resume and accelerate features

Available packages and stand-alone options

- ▶ Sport package
- ▶ Navigation package without Audi connect®⁴
- ▶ Driver Assistance package
- ▶ 19" 5-double-spoke Offroad design wheels
- ▶ Black cloth headliner
- ▶ Balsamic Brown Walnut Wood decorative inlays
- ▶ Power tailgate



Xenon plus headlights with LED daytime running lights



LED taillights



Dual-zone automatic climate control

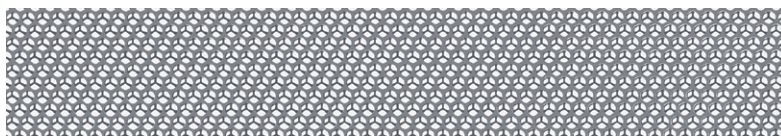

Aluminum Satellite decorative inlay



18" 5-arm design wheels with 235/50 all-season tires



Aluminum roof rails



Panoramic sunroof



Split folding 60/40 rear seatback with pass-through



Leather-wrapped shift knob



¹ SiriusXM Satellite Radio and SiriusXM Traffic subscriptions are sold separately or as a package after trial period and are continuous until you call SiriusXM to cancel. See Customer Agreement for complete terms and more information at www.siriusxm.com. SiriusXM Traffic service available in select markets. SiriusXM U.S. Satellite Service available only to those in the 48 contiguous U.S.A., D.C. and Puerto Rico (with coverage limitations). ² Requires compatible device. ³ Some Audi models are equipped with a keyless ignition feature. The details as to how the system works can vary, and Audi owners should consult their owner's literature or an authorized Audi dealer if they have further questions about the operation of this feature. Please note that Audi warns against leaving the vehicle unattended with the engine running, particularly in enclosed spaces. ⁴ Always pay careful attention to the road, and do not drive while distracted. The features and technologies discussed above are optional, may require an additional subscription with separate terms and conditions, and should be used only when it is safe and appropriate. The Wi-Fi® hotspot feature is intended for passenger use only.

Prestige

The following highlighted features of the Q3 Prestige add to or replace the highlighted features of the Q3 Premium Plus

- ▶ Power-adjustable, power-folding, driver-side auto-dimming, heated exterior side mirrors
- ▶ Power tailgate
- ▶ Stainless steel trunk sill and door sills
- ▶ MMI® navigation plus with voice control system¹
- ▶ Audi connect® with six-month trial subscription²
- ▶ SiriusXM® Traffic with four-year subscription³
- ▶ Color driver information system
- ▶ BOSE® Surround Sound System with 14 speakers, AudioPilot® noise compensation and 465 watts
- ▶ Parking system plus with rear view camera (front and rear acoustic parking sensors)

Available packages and stand-alone options

- ▶ Sport package
- ▶ 19" 5-double-spoke Offroad design wheels
- ▶ Black cloth headliner
- ▶ Balsamic Brown Walnut Wood decorative inlays



Audi connect® online services²



Color information system

MMI® navigation plus¹

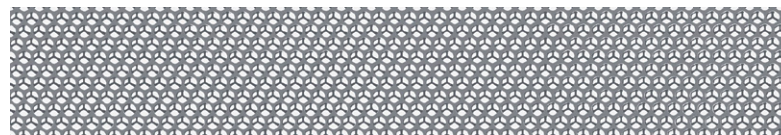

Aluminum Satellite decorative inlay



18" 5-arm design wheels with 235/50 all-season tires



BOSE® Surround Sound System



Stainless steel trunk sill and door sills



Power tailgate



Audi side assist



¹ MMI® navigation plus depends on signals from the worldwide Global Positioning Satellite network. The vehicle's electrical system and existing wireless and satellite technologies must be available and operating properly for the system to function. The system is designed to provide you with suggested routes in locating addresses, destinations and other points of interest. Changes in street names, construction zones, traffic flow, points of interest and other road system changes are beyond the control of Audi of America, Inc. Complete detailed mapping of lanes, roads, streets, toll roads, highways, etc., is not possible, therefore you may encounter discrepancies between the mapping and your actual location. Please rely on your individual judgment in determining whether or not to follow a suggested MMI® navigation plus route. For mapping updates, please see your Audi dealer or call 1-800-FOR-AUDI for details. ² Always pay careful attention to the road, and do not drive while distracted. The features and technologies discussed above are optional, may require an additional subscription with separate terms and conditions, and should be used only when it is safe and appropriate. The Wi-Fi® hotspot feature is intended for passenger use only. ³ SiriusXM Satellite Radio and SiriusXM Traffic subscriptions are sold separately or as a package after trial period and are continuous until you call SiriusXM to cancel. See Customer Agreement for complete terms and more information at www.siriusxm.com. SiriusXM Traffic service available in select markets. SiriusXM U.S. Satellite Service available only to those in the 48 contiguous U.S.A., D.C. and Puerto Rico (with coverage limitations).

Packages

Analogous to the progressive nature in which all our vehicles are engineered are the technologies and offerings available in a variety of packages to enhance the experience of driving an Audi vehicle. To prove that luxury has progressed, we invite you to explore the package that best outfits your Audi Q3.

Driver Assistance package

Available on Premium Plus models

- ▶ Audi side assist
- ▶ Parking system plus with rear view camera

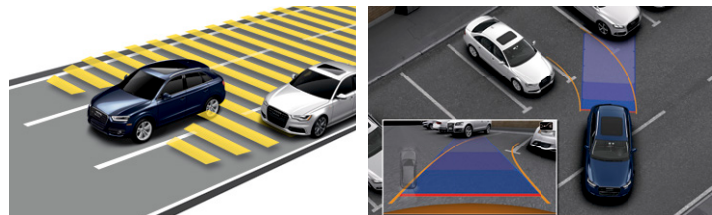

MMI® navigation plus package

Available on Premium Plus models

- ▶ MMI® navigation plus with voice control¹
- ▶ SiriusXM® traffic with four-year subscription²
- ▶ Color driver information system
- ▶ HD Radio™ Technology



Sport package

Available on all models

- ▶ Three-spoke multifunction steering wheel with shift paddles
- ▶ Twelve-way power front sport seats, including four-way power lumbar adjustment
- ▶ Audi drive select



Options

In addition to the many packages available for your Audi Q3, there are also a host of a la carte options to outfit your vehicle. From a wheel offering and choices of elegant interior trims to a power tailgate, there's an option to help better complement your lifestyle.



19" 5-double-spoke Offroad design wheels with 255/40 all-season tires³ (optional on all models)



Balsamic Brown Walnut Wood decorative inlays (optional on all models)



Black cloth headliner (optional on all models)



Power tailgate (optional on Premium Plus models)

¹ MMI® navigation plus depends on signals from the worldwide Global Positioning Satellite network. The vehicle's electrical system and existing wireless and satellite technologies must be available and operating properly for the system to function. The system is designed to provide you with suggested routes in locating addresses, destinations and other points of interest. Changes in street names, construction zones, traffic flow, points of interest and other road system changes are beyond the control of Audi of America, Inc. Complete detailed mapping of lanes, roads, streets, toll roads, highways, etc., is not possible, therefore you may encounter discrepancies between the mapping and your actual location. Please rely on your individual judgment in determining whether or not to follow a suggested MMI® navigation plus route. For mapping updates please see your Audi dealer or call 1-800-FOR-AUDI for details. ² SiriusXM Satellite Radio and SiriusXM Traffic subscriptions are sold separately or as a package after trial period and are continuous until you call SiriusXM to cancel. See Customer Agreement for complete terms and more information at www.siriusxm.com. SiriusXM Traffic service available in select markets. SiriusXM U.S. Satellite Service available only to those in the 48 contiguous U.S.A., D.C. and Puerto Rico (with coverage limitations). ³ High-performance tires are designed for better performance and handling in warm climates. When driving in cold, snowy or icy weather, you should equip your vehicle with four all-season or winter tires, which offer better traction under those conditions. We suggest you use the Audi-recommended winter or all-season tires specified for your Audi. High-performance tires also have a lower aspect ratio that aids performance and handling. Driving over rough or damaged road surfaces, as well as debris, curbs and other obstacles, can cause serious damage to wheels, tires, vehicle body and suspension parts. Be careful to avoid road hazards and reduce your speed, especially if your vehicle is equipped with low-profile tires. Please also remember when making your selection that, while these tires deliver responsive handling, they may ride less comfortably and make more noise than others. Finally, these tires may wear more quickly than other choices. It is important that the inflation pressure is regularly checked and maintained at recommended levels.

Exterior Colors

Brilliant Black

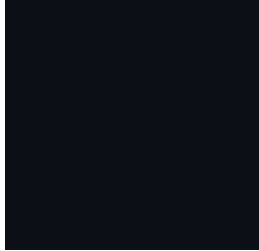

Cortina White

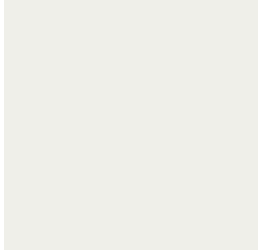

Cobalt Blue metallic



Glacier White metallic

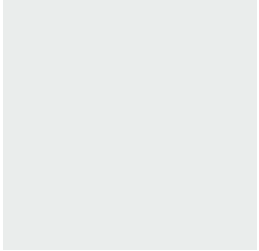

Florett Silver metallic



Monsoon Gray metallic

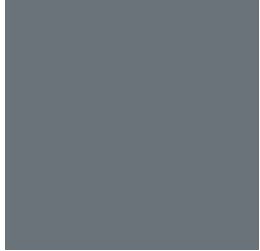

Mythos Black metallic



Tundra Brown metallic

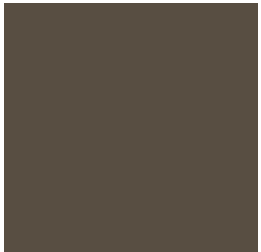

Seat Selections | Interior Colors

Standard Seat



Sport Seat



Black leather

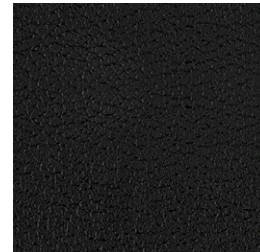

Standard, Sport

Chestnut Brown leather



Standard, Sport

Titanium Gray leather

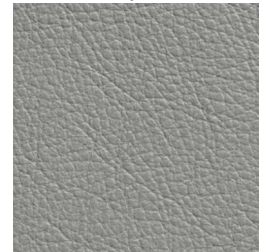

Standard, Sport

Technical Specifications

Engineering | Performance

	Q3 2.0T
Engine type	Four-cylinder
Engine block/Cylinder head	Cast-iron/ Aluminum-alloy
Displacement (cc)/Bore and stroke (mm)	1,984/82.5 x 92.8
Horsepower (@ rpm)	200 @ 5,100–6,000
Torque (lb-ft @ rpm)	207 @ 1,700–5,000
Compression ratio	9.6:1
Valvetrain	16-valve DOHC
Induction/Fuel injection	Turbocharged/TFSI®
Acceleration FWD/quattro® (0–60 mph)	7.8/8.2 seconds
Top track speed ¹	130 mph

Transmission | Drivetrain

Six-speed Tiptronic® automatic transmission with front-wheel drive (Gear ratios: 1st: 3.949, 2nd: 2.303, 3rd: 1.556, 4th: 1.164, 5th: 0.86, 6th: 0.688, Reverse: 3.422, Final drive: NA)	■
quattro® all-wheel drive	Available

Body | Suspension | Chassis

Fully galvanized steel unibody with aluminum hood and tailgate and multistep anti-corrosion protection	■
Five-link front suspension	■
Trapezoidal-link rear suspension	■
Ventilated front disc/Solid rear disc brakes	■
Electromechanical power steering system	■
Steering ratio	16.4:1
Turning diameter, curb-to-curb (ft)	38.7

■ Standard — Not applicable **NA** Information not available at time of printing

Exterior measurements

	Q3 2.0T
Wheelbase (in)	102.5
Length (in)	172.6
Height (in)	62.6
Overall width with mirrors (in)	79.5
Overall width without mirrors (in)	72.1
Track front/rear (in)	61.9/62.0
Curb weight FWD/quattro® (lb)	3,494/3,682
Drag coefficient (Cw)	0.32

Interior measurements

Head room with sunroof (in, front/rear)	36.9/37.4
Leg room (in, front/rear)	40.0/31.1
Shoulder room (in, front/rear)	55.8/53.6
Cargo volume (cu ft, rear seatbacks up/folded)	16.7/48.2
Seating capacity	5

EPA mileage estimates | Capacities

Tiptronic® automatic transmission with front-wheel drive (city/highway/combined) ²	20/29/23
Tiptronic® automatic transmission with quattro® all-wheel drive (city/highway/combined) ²	20/28/23
Engine oil (qt)	4.9
Fuel (gal)	16.9
Required fuel	Premium
Emissions rating	ULEV

¹ Top track speed is electronically limited in the U.S. Always obey all speed and traffic laws. ² EPA estimates. Your mileage will vary and depends on several factors, including your driving habits and vehicle condition. See www.fueleconomy.gov for details.

Featured Content

Safety Security	2.0T Premium Plus	2.0T Prestige
Driver and front passenger airbags, front thorax side airbags and Sideguard® head curtain airbags ¹	■	■
Front passenger occupant detection for airbags ¹	■	■
Safety belt reminder for driver and front passenger	■	■
Lower Anchors and Tethers for CHildren (LATCH) in rear seats	■	■
Power central locking system with safety unlock feature if airbags deploy	■	■
Electronic Stability Control (ESC) with Offroad mode and traction control (ASR)	■	■
Anti-lock Brake System (ABS) with Electronic Brake-pressure Distribution (EBD) and brake assist	■	■
Hill descent assist	■	■
Tire-pressure monitoring system	■	■
Electromechanical parking brake	■	■
Anti-theft alarm system with immobilizer	■	■

Exterior	2.0T Premium Plus	2.0T Prestige
Singleframe® grille	■	■
Xenon plus headlights with LED daytime running lights	■	■
Automatic headlights	■	■
Front and rear fog lights	■	■
LED taillights	■	■
Power-adjustable heated exterior side mirrors	■	—
Power-adjustable, power-folding, driver-side auto-dimming, heated exterior side mirrors	—	■
LED turn indicator lights integrated into the exterior side mirrors	■	■
Heated windshield washer nozzles	■	■
Rear privacy glass	■	■
Aluminum roof rails	■	■
Aluminum trim around exterior windows	■	■
Power tailgate	Available	■
Tailgate spoiler	■	■
Dual exhaust outlet (driver's side)	■	■

■ Standard — Not applicable

Interior	2.0T Premium Plus	2.0T Prestige
Dual-zone automatic climate control	■	■
Three-spoke multifunction steering wheel	■	■
Three-spoke multifunction steering wheel with shift paddles	Available	Available
Tilt and telescopic manually adjustable steering column	■	■
Auto-dimming interior rear view mirror with digital compass	■	■
Illuminated locking glove compartment	■	■
Leather-wrapped shift knob	■	■
Folding and sliding front center armrest with height adjustment	■	■
Eight beverage holders (four cup and four bottle)	■	■
Stainless steel trunk sill and door sills	—	■
Ambient LED interior lighting	■	■
Black cloth headliner	Available	Available
Dual front sun visors with lighted vanity mirrors	■	■
Power windows with one-touch up/down operation and pinch protection	■	■
Panoramic sunroof	■	■

Seating	2.0T Premium Plus	2.0T Prestige
Leather seating surfaces	■	■
Twelve-way power front seats, including four-way power lumbar adjustment	■	■
Twelve-way power front sport seats, including four-way power lumbar adjustment	Available	Available
Heated front seats	■	■
60/40 split folding rear seat with pass-through armrest and cupholders	■	■

¹ Airbags are supplemental restraints only and will not deploy in all crash circumstances. Always use safety belts and seat children only in the rear, using restraint systems appropriate for their size and age.

Featured Content

Infotainment | Technology

	2.0T Premium Plus	2.0T Prestige
MMI® navigation plus with voice control system ¹	Available	■
Audi connect® with six-month trial subscription ²	—	■
Driver information system	■	—
Color driver information system	Available (with navigation)	■
Audi concert radio with ten speakers and single CD player with MP3 playback capability	■	—
BOSE® Surround Sound System with 14 speakers, AudioPilot® noise compensation and 465 watts	—	■
HD Radio™ Technology	■	■
SiriusXM® Satellite Radio with 90-day trial subscription ³	■	■
SiriusXM® Traffic with four-year subscription ³	Available (with navigation)	■
SD card slot for audio playback of MP3 music files	■	■
Audi music interface with iPod® integration	■	■
BLUETOOTH® streaming audio ⁴	■	■
BLUETOOTH® wireless technology preparation for mobile phone ⁴	■	■
12-volt power outlets	■	■
Audi advanced key—keyless start, stop and entry (front doors and tailgate) ⁵	■	■
Cruise control with coast, resume and accelerate features	■	■
Audi side assist	Available	■
Audi drive select	Available	Available
Parking system plus with rear view camera (front and rear acoustic parking sensors)	Available	■
Rain/light sensor for automatic windshield wipers and headlights	■	■

Accessories

Add distinction, versatility and the ultimate in self-expression with Audi Genuine Accessories. Whether you load the cargo carrier with climbing gear or add a set of stylish new wheels, we have the accessories that will help enhance every facet of your lifestyle. When purchased from an authorized dealer, all pieces are backed by your vehicle's 4-year/50,000-mile limited warranty or for 12 months/12,000 miles from the accessory purchase date, whichever is greater.⁶ If you're looking to personalize or protect the vehicle you love, we have an Audi-designed solution that works for you.



19" 5-arm Pila summer wheel—Anthracite

The uniquely shaped design of this anthracite wheel gives your Q3 a more distinct presence. Also available in black.



17" 5-arm semi-Y winter wheel and tire package

Adding style and performance, this winter wheel and tire package features winter tires specifically engineered to help improve traction and handling in snow and ice—and even on dry roads—in temperatures below 45°F.^{7,8}



Splash guards

Help protect the finish of your Q3 with custom-fit splash guards made of crack-resistant rubber. They are available in sets of two for front or rear.



All-weather cargo mat

Custom fit for your Q3, the raised outside edge of the cargo mat helps contain spills and protects cargo-area carpeting from stains. The textured material helps control load shifting.

More Q3 Accessories

► Audi Genuine Sport and Design Accessories

Express your own style with enhancements designed to make every mile more enjoyable—and more yours.

► Audi TravelSpace Transport Accessories

Accommodate your lifestyle and satisfy your sense of adventure with our innovative transport solutions.

► Audi Guard Comfort and Protection Accessories

Keep your Q3 in peak condition without sacrificing style. Functional, practical items help protect what you love.

► Audi Guard Car Care Products

Your Q3 deserves the very best. Care for it with superior products designed by Audi, especially for Audi vehicles.

See all the accessories offered for your Q3 by visiting parts.audiusa.com.

¹ MMI® navigation plus depends on signals from the worldwide Global Positioning Satellite network. The vehicle's electrical system and existing wireless and satellite technologies must be available and operating properly for the system to function. The system is designed to provide you with suggested routes in locating addresses, destinations and other points of interest. Changes in street names, construction zones, traffic flow, points of interest and other road system changes are beyond the control of Audi of America, Inc. Complete detailed mapping of lanes, roads, streets, toll roads, highways, etc., is not possible, therefore you may encounter discrepancies between the mapping and your actual location. Please rely on your individual judgment in determining whether or not to follow a suggested MMI® navigation plus route. For mapping updates please see your Audi dealer or call 1-800-FOR-AUDI for details. ² Always pay careful attention to the road, and do not drive while distracted. The features and technologies discussed above are optional, may require an additional subscription with separate terms and conditions, and should be used only when it is safe and appropriate. The Wi-Fi® hotspot feature is intended for passenger use only. ³ SiriusXM Satellite Radio and SiriusXM Traffic subscriptions are sold separately or as a package after trial period and are continuous until you call SiriusXM to cancel. See Customer Agreement for complete terms and more information at www.siriusxm.com. SiriusXM Traffic service available in select markets. SiriusXM U.S. Satellite Service available only to those in the 48 contiguous U.S.A., D.C. and Puerto Rico (with coverage limitations). ⁴ Requires compatible device. ⁵ Some Audi models are equipped with a keyless ignition feature. The details as to how the system works can vary, and Audi owners should consult their owner's literature or an authorized Audi dealer if they have further questions about the operation of this feature. Please note that Audi warns against leaving the vehicle unattended with the engine running, particularly in enclosed spaces. ⁶ Audi Genuine Accessories purchased from an authorized Audi dealer are covered for the greater of: (1) the accessory limited warranty period (12 months or 12,000 miles, whichever occurs first) from the time of purchase; or (2) the remainder of the Audi New Vehicle Limited Warranty period (4 years or 50,000 miles, whichever occurs first). See your authorized Audi dealer for details. ⁷ Remember that even with high-quality winter tires, you must always drive according to the conditions of the road and maintain more distance from other vehicles since braking distances will be longer on ice- and snow-covered roads. ⁸ Package offerings are subject to change without notice. See your authorized Audi dealer for details.



Note: A word about this brochure. Audi of America, Inc., believes the specifications in this brochure to be correct at the time of printing. However, specifications, standard equipment, options, fabrics, and colors are subject to change without notice. Some equipment may be unavailable when your vehicle is built. Please ask your dealer for advice concerning current availability of standard and optional equipment, and your dealer will verify that your vehicle will include the equipment you ordered. Vehicles in this brochure are shown with optional equipment. See your dealer for complete details on the Audi New Vehicle Limited Warranty, twelve-year limited warranty against corrosion perforation, and Audi 24/7 Roadside Assistance. (Roadside assistance coverage provided by Road America in the U.S. Certain conditions apply; see your dealer for details.) Tires supplied by various manufacturers. "Audi," all model names, "Audi connect," "e-tron," "FSI," "MMI," "quattro," "Sideguard," "Singleframe" and the Singleframe grille design, "TFSI," "Truth in Engineering," "ultra," and the four rings logo are registered trademarks of AUDI AG. "AudioPilot" is a registered trademark of the BOSE Corporation. The BLUETOOTH word mark and logos are owned by the Bluetooth SIG, Inc., and any use of such marks by AUDI AG is under license. "BOSE" is a registered trademark of the BOSE Corporation. "Google," "Google Earth" and "Google Voice" are trademarks of Google Inc. "HD Radio" and the HD Radio logo are proprietary trademarks of iBiquity Digital Corporation. "iPod" is a registered trademark of Apple Inc. "SiriusXM" and all related marks and logos are trademarks of Sirius XM Radio Inc. and its subsidiaries. "TDI" is a registered trademark of Volkswagen AG. "Tiptronic" is a registered trademark of Dr. Ing h.c. F. Porsche AG. "Wi-Fi" is a registered trademark of the Wi-Fi Alliance. All other trademarks are the property of their respective owners. Some European models shown.

2015 | Q3

Audi of America

Audiusa.com

Facebook.com/Audi

AoA1515491

© 2014 Audi of America, Inc. Printed in U.S.A.