



A7

Audi A7 | S7 | RS 7

Audi
Truth in Engineering 



A close-up photograph of a car's interior, showing a textured, dark grey fabric surface. A white rectangular text box is centered on the image. The text is in a clean, sans-serif font. The background shows parts of a car seat and a door panel.

Reflecting on what matters most to us.

In so many ways, it's really all connected. How an Audi vehicle is engineered and designed isn't simply a matter of physics or architecture, it's a systematic compilation of disparate disciplines and ideas, forged into something iconic, sophisticated and powerful. What you feel behind the wheel is, in so many ways, a product of the knowledge and imagination of human history. The principles of Newtonian laws, sure—but also the grace of choreography, time-honored artisanal craftsmanship and the connectivity of modern life. The end result of these inspirations is your Audi—a thing meaningful, intuitive and strong. We employ the sum of our skills and understanding to reflect something that goes deeper than our machines.

Confirmation that sculpted power is a hereditary trait.





A7 | S7 | **RS7**

The Audi A7 and its siblings S7 and RS 7 are ready to pass down all aspects of their distinctive design, unrivaled luxury and dynamic performance.

A predisposition for daring, free expression is clearly written in their DNA. You can see this communicated boldly in each incarnation, from the Audi A7 to the S7 to the RS 7. Their captivating lines and singular silhouettes are tasked with sending a definitive message: convention is unwelcome. Take notice of the signature Singleframe® grille and sloping roofline present on each model; this is artful on a large scale. The family resemblance is only part of their unmistakable bond. An extensive list of advanced technologies—MMI® touch, Google Earth™ integration and an embedded 4G LTE Wi-Fi® hotspot for passenger use—is the first indication that these vehicles are built for a bold new future. The future will also demand power. Of course, we're prepared, with a 333-hp supercharged TFSI® V6 or available TDI® clean diesel engine in the A7, a 450-hp, 4.0-liter TFSI® V8 in the S7 and 560-hp in the RS 7. And with one of these engines mated to our legendary quattro® all-wheel drive, you will experience a feeling of absolute freedom that could only come from driving a true performance icon.



1. Always pay careful attention to the road, and do not drive while distracted. The features and technologies discussed above are optional, may require an additional subscription with separate terms and conditions, and should be used only when it is safe and appropriate. The Wi-Fi® hotspot feature is intended for passenger use only.





The irrepressible actuality of light.

Light is a wave and an energy. It's also a feeling. And an inspiration. Light is a physical manifestation and a spiritual metaphor. For Audi designers, light represents the soul of automotive design. We use it to give lines context, add a shimmering allure, or give shapes a visual texture or depth. In the sun or on a city street, the vehicle becomes luminescent, a seductive, ever-shifting configuration of energy itself, expressed in the brilliance of each design line.

The Tornado (mid-body) and Dynamic (lower) lines complement the gracefully sloping Roof line, which defines the vehicle profile. Together they add a sense of motion to shape and light.



It's been said that only the brave few get powerful works of bold ambition.

Great design doesn't just happen. It's an exacting process that helps ensure that every design line not only adds to the character, but also, ultimately, helps tell a compelling, cohesive story. You notice it in the way the lines flow into the redesigned Singleframe® grille, where the wide shape and crisp, chamfered corners create a sense of sportiness that pairs nicely with the flat lower bumper line, for an overall effect of power and stability. The Tornado line is what really drives the plot, though. Bisecting the body profile, it runs along the length of the vehicle, giving it a progressive contour that tells the world that there's distinction here, not convention. It's the kind of memorable characteristic that brings the bold story of design to life.



2016 Audi A7 3.0T Prestige shown in Florett Silver metallic with available equipment.

How our elements of style write a new design language.

For the Audi A7, we didn't want to speak in conventional terms. So we used design to communicate in a new, intriguing kind of dialect. You'll understand this idiom when you see the sculpted body, or distinctive details like the new, gleaming integrated trapezoidal exhaust outlets and tastefully redesigned LED daytime running lights and taillights. Each line, slope and angle creates the context. With the A7, we are speaking a new language that everyone will be obsessed with learning.



The sloping rear Roof line gives the Audi A7 a coupe-like silhouette, flowing into the design lines running down the side, to frame the taillights.



Adaptive rear spoiler

An example of thoughtful integration, the adaptive rear spoiler doesn't affect the vehicle's visual appeal when not in use. At speeds over 80 mph, it automatically deploys, helping provide additional downforce to enhance the dynamic performance of the A7!

Full LED headlights

Welcome to the future of lighting. Full LED headlights are standard on every A7 model, helping ensure a long life and, with a near perfect re-creation of daylight, a brilliantly lit road ahead.



2016 Audi A7 3.0T Prestige shown with Atlas Beige leather and available equipment.

You are at the center of a command performance.

In here, you'd be excused for thinking that the universe revolves around you—because, from the moment you notice the wraparound curve of the Audi A7 dashboard, and the driver-centric layout, it does. That thoughtfulness is put into every detail of Audi fit and finish, best reflected in places others hope you don't notice, like virtually seamless panel gaps, or the audible precision of a turned knob. Putting the driver in command results in innovations like the ultrathin eight-inch MMI® display, which rises from the top of the Aluminum-optic air-vent bezel, closer to the driver's line of sight, helping maintain your focus on the road ahead. It all adds up to a driving experience that feels more about *you* than anything else.

An expertly crafted gear selector helps provide a more ergonomic experience, while Aluminum-optic elements, including the MMI function keys, offer elegance in true Audi form.



Decorative interior inlays

Adding a touch of warmth and sophistication to an already regal interior are beautifully crafted decorative inlays. Available in numerous finishes, they help create an interior space that speaks to your artistic sensibilities.

Indulge us in our efforts to indulge you.

We want to pamper you, so why not let us? Our exacting design team rethought how interior appointments should blend style with purpose, to make yours a more sophisticated experience. With matchless materials, eight-way power front seats and four-zone automatic climate control, you can create an alluring cabin environment tailored to you. Indulge in the smallest details, like an available heated steering wheel, or available ventilated front seats. Cultivate an indulgence or two.



Cargo capacity

With 24.5 cu ft of cargo capacity with the seatbacks upright, you'd be forgiven for thinking the A7 might moonlight as a much larger vehicle. And with all that extra space, you can forget about deciding between bringing an extra golf bag or more clothes. Bring them both.

Power rear tailgate with hands-free release

Carefully integrated into the rear design, the power rear tailgate on the A7 gives you programmable endpoints so you can adjust the opening to the height you choose to better accommodate personal preferences and tighter spaces. And when your hands are full, a simple wave of your foot under the bumper can open the tailgate for you.



Four-zone automatic climate control

Take it as a clear indication that this interior is all about pleasing its passengers. With the standard four-zone automatic climate control, almost every person in the vehicle has the ability to dial in their ideal temperature.

Individual contour front seats

Providing luxury beyond the status quo, available 18-way individual contour front seats put you in nearly full control of your comfort. A massage function with five different programs helps soothe on long drives, while a memory feature helps ensure that, once you or your front passenger find the perfect setting, it'll stay that way.



The wraparound curve of the dashboard will envelop you in our classic driver-centric fashion, while its shape and numerous trim options convey true sophistication.

A showcase of our driving desire for superior engineering.

It should be apparent from our drivetrain options that we strive for engineering perfection. So no matter if you choose gasoline or diesel, you'll experience the kind of dynamic performance and efficiency people have come to expect of Audi.¹ And with an advanced transmission and road-gripping capability of quattro[®] all-wheel drive applying all that power to the ground, it will feel as good as its engineering suggests.

POWER
→
↓

V6 TFSI[®] engine

The 333-horsepower 3.0-liter TFSI V6 engine is paired with FSI[®] direct injection and a belt-driven supercharger that features a magnetic clutch for greater efficiency and counter-rotating four-vane rotors that force air on-demand through dual intercoolers at boosted pressures.¹ It is this combination of engineering achievements that allows for nearly instantaneous buildup of 325 lb-ft of torque directly off idle engine speeds.

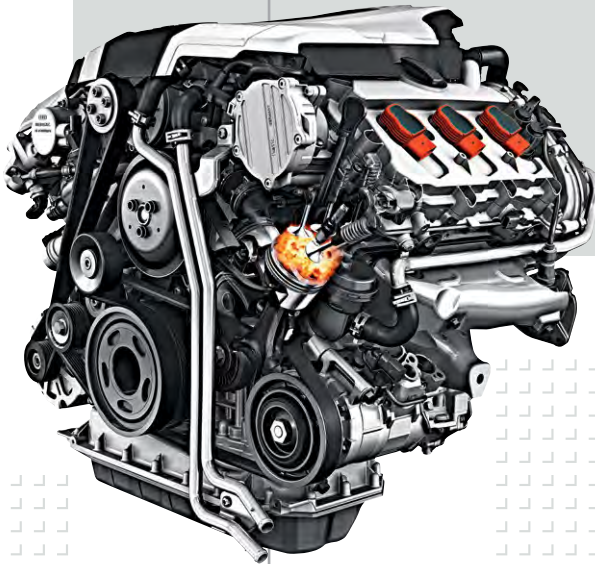

TDI[®] clean diesel engine

Taking advantage of the greater power density of diesel fuel over traditional gasoline, the available 240-hp 3.0-liter TDI[®] clean diesel V6 delivers incredible torque (428 lb-ft) and passing power, while boasting impressive fuel efficiency numbers.¹ It also produces fewer emissions with a combination of Piezo direct injection, a high compression ratio, and innovative after-exhaust treatment that helps eliminate up to 95% of diesel NOx emissions.

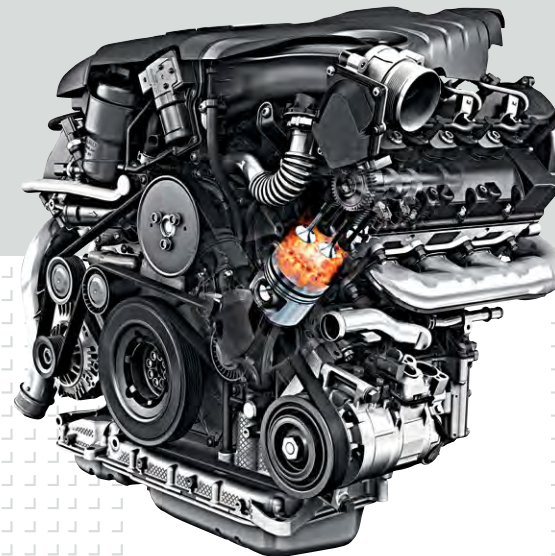

APPLICATION
→
↓

Eight-speed Tiptronic[®] automatic transmission

The eight-speed Tiptronic[®] automatic transmission in the Audi A7 offers eight optimized, carefully chosen gear ratios. Selected automatically or via its console-mounted gear selector or steering wheel with shift paddles, precise shifts are delivered without sacrificing the smooth action of the Tiptronic[®] automatic. A high final drive ratio allows optimization of lower gears, yet the transmission's upper range emphasizes fuel economy—particularly at highway speeds.

There is more information on the TDI[®] clean diesel model line in the TDI[®] clean diesel brochure. For details, see your dealer, go to audiusa.com or download the digital brochure from the Audi library app.

quattro® all-wheel drive

There is a reason quattro® has been known as the all-wheel-drive standard since its inception — it has helped us to win races all over the world, and lots of them. But it's not just a performance-enhancing technology, it has also become the proven foul-weather friend. Under normal driving conditions, the center differential splits torque at a ratio of 40:60, front to rear (maximizing performance on dry roads), but, as conditions change and become more challenging, the ratio is optimized to help maximize grip. This translates to traction and a more confident driving experience.

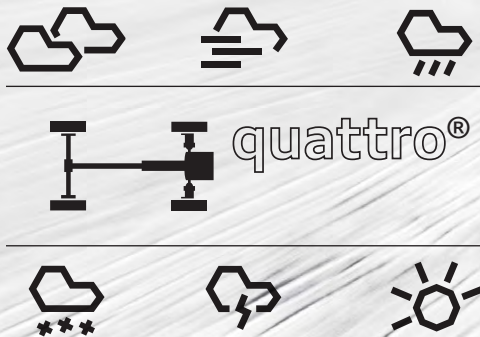
**Audi drive select**

At Audi, we believe you should be the ultimate master of your road-going domain. That's why we created the Audi drive select system. It gives you the ability to adjust the vehicle's steering, throttle response and transmission shift characteristics with the utmost of ease (Audi S7 and Audi RS 7 models add suspension and sport differential as well as dynamic steering control if equipped). And with four modes to choose from, when almost any kind of road comes into question, Audi drive select will let you answer.

- ▶ **Comfort mode**
Perfect for those long highway stretches, this setting adds optimized steering and a closer shift pattern to help provide a more relaxed drive.
- ▶ **Dynamic mode**
Tighter steering and a more responsive throttle help give this setting an aggressive feel and focused performance.
- ▶ **Auto mode**
The best of both worlds, dialed to automatically adjust settings for a seamless combination of comfort and responsiveness based on your driving style and road conditions.
- ▶ **Individual mode**
Drive your way — this mode allows you to adjust the steering, throttle and transmission upshifts to your style.

Start-stop efficiency system

As an intelligent vehicle system, this available highly effective engine management program can help lower fuel consumption as well as CO₂ emissions by automatically shutting off your engine while you wait at a red light or, perhaps, during certain stop-and-go driving. Once you are ready to resume, or if other critical vehicle systems require it, the engine will restart nearly instantaneously.





Embodying the essence of performance.

For Audi engineers, power delivery is a primal thing. Sure, we sweat over balance, we obsess over precise handling, we shave off ounces and even pounds where we can to produce an improved response, quick acceleration and dynamic cornering, but in our hearts, at Audi, we want performance that inspires confidence. We have a heritage of racing success—and that helps us make the case—but it's a truer testament of engineering to make it work on the street, the highway, the commute. To engineer those moments where the rest of the vehicle seems to disappear and you are well into the moment of exhilaration, the light turns green, you accelerate. Performance—sculpted, engineered, Audi performance—makes its own case for the greatness of your vehicle.¹



S7

Aluminum-optic blades integrated into the lower front bumper, Aluminum-optic side mirrors and Platinum Gray Singleframe® grille accents assert our intentions.



2016 Audi S7 shown in Daytona Gray pearl with available equipment.

Raw power. Well done.

There's power, and then there's the kind of power that exerts itself with style and class. The bold, muscular body and S model design cues of the Audi S7 are perfect examples of this, providing constant reminders that this is a performance car above all else. A 450-hp, 4.0-liter TFSI® V8 with cylinder on demand™ engine efficiency technology, as well as the start-stop efficiency system;¹ the relentless grip of quattro® all-wheel drive, the enhanced agility of an available sport differential and the stopping power of large, high-performance brakes leave no questions about this vehicle's ultimate intentions. The same could be said about the S tronic® dual-clutch transmission, quad exhaust outlets and available dynamic steering. All are clear reminders that this is a luxury sports car that doesn't hold anything back. Consider this a new class of power.

> 4.0-liter turbocharged TFSI® V8 engine

> 450 hp/406 lb-ft torque

> 0-60 mph in 4.5 seconds

> Top track speed of 155 mph²



Audi adaptive air suspension

Offering the best of both dynamic handling and comfort, Audi adaptive air suspension also allows for speed-dependent lowering of the body, resulting in a lower center of gravity, which helps improve your directional stability. Speed or driver-selectable control logic adjusts the air suspension springs at all four wheels, adjusting the suspension in milliseconds.

¹ EPA estimates. Your mileage will vary and depends on several factors, including your driving habits and vehicle condition. See www.fueleconomy.gov for details.

² Top track speed is electronically limited in the U.S. Always obey all speed and traffic laws.

S7



Equally compelling on the inside, the Audi S7 features Valcona leather seats with expertly sewn and distinctive diamond-stitching.



Audi design selection

How do you turn an already extraordinary space into an even higher form of luxury? The available Arras Red Audi design selection. Featuring Arras Red Valcona leather, Granite Gray contrast stitching, along with Carbon Twill, Red decorative inlays, it speaks performance in a language everyone will recognize.



More than a touch of genius.

The visceral reaction you get when you accelerate in the Audi S7 may only be matched by the exhilaration of engaging its interior. A kind of genius is found in a driver-centric cockpit that helps allow for total control, and in signature sport-contoured seats that cradle you through a corner. It's obvious—this is a performance five-door coupe that never lets up on powerful sophistication. It's the kind of style defined by available Carbon Atlas decorative inlays, a style of distinction, and brashness. The S7 is filled with bold touches, because to drive one requires more than a touch of boldness.

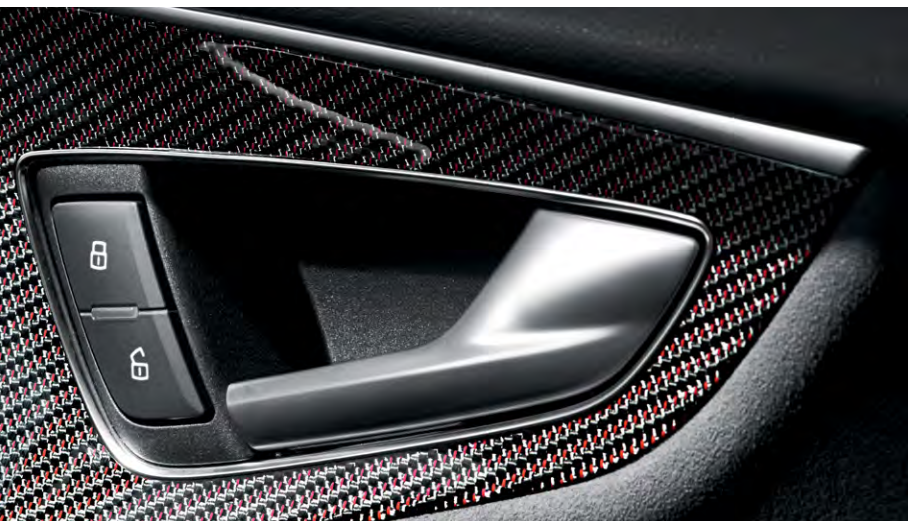

Sport-contoured interior design

Even on the inside, this vehicle's ultimate purpose is impossible to ignore. Just consider the sport-contoured seating, ample bolsters and carefully integrated head restraints. And just in case you miss all that, the S7 signifier emblazoned on the front seats and flat-bottom sport steering wheel with shift paddles will surely grab your attention.





RS 7

RS model design cues like honeycomb-mesh inserts and matte aluminum side mirror housings and window trim, articulate power above all else.

2016 Audi RS 7 shown in Daytona Gray pearl with Black leather and available equipment.

The only thing we left out was restraint.

When designing a high-performance vehicle like the RS 7, we wanted the finished product to provoke and move the person viewing it. We went big, with bold air intakes and a pronounced, sleek chin spoiler. We also went lower, having it sit closer to the ground than others in the family do. Inside, we gave it the unmistakable look of power, with a wide array of high-end touches like Valcona leather with honeycomb stitching and RS-design Carbon Fiber inlays. It is a performance vehicle cut with a sculptor's tools, an ingenious blend of unrestrained lines and crafted fit. It is the result of an obsession with timeless design.



Audi Sport®

With a long and storied history on tracks all over the world, Audi Sport is the pinnacle of performance, and is signified by the red rhombus. It marries the best of our race-winning technology with legendary Audi refinement and luxury, giving you a taste of victory on every drive.

Performance exhaust

Oval exhaust outlets and an available sport exhaust system will help ensure that when you pass somebody on the highway, they'll know exactly what kind of vehicle just left them in its rearview mirror!¹



RS 7

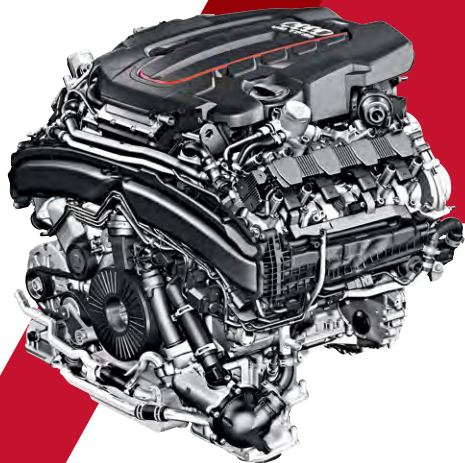

4.0-liter turbocharged TFSI® V8

Ensuring a thundering performance, the 560-hp TFSI V8 in the RS 7 makes for an incredible 140-hp per liter for exhilarating acceleration at nearly any rpm. And with cylinder on demand™ technology, which deactivates four of the eight cylinders under light loads, you can be sure it's using fuel just as wisely.^{1,2}

> 4.0-liter turbocharged TFSI® V8 engine

RS model wave-design brakes

In contrast to traditional, round cast-iron brake discs, wave-design discs are lighter and more resistant to fading. Combined with a unique wave-cut design, which reduces weight further and provides innovative ventilation for optimal cooling, they deliver the kind of precise control and stopping power necessary in a vehicle of this caliber.

> 560 hp/516 lb-ft torque



> 0-60 mph in 3.7 seconds

> Top track speed of 174 mph²

Absolute power does corrupt your desire for any other vehicle.

■ No, the RS 7 isn't a retiring type. It's a vibrant, strutting, gleaming machine that seemingly pulsates even when standing still. This is a true track-performance vehicle, with all the power such a title promises — 560 hp unleashed by a 4.0 TFSI® V8, with a top track speed of 174 mph²—and the road-feel of a more refined performer, articulated through dynamic steering, Audi adaptive air suspension (or an available highly rigid and responsive DRC® suspension system) and quattro® all-wheel drive with sport differential. And the moment you feel the thundering sonic punch of the available sport exhaust, you'll know that you'll never go back to just another sports car.

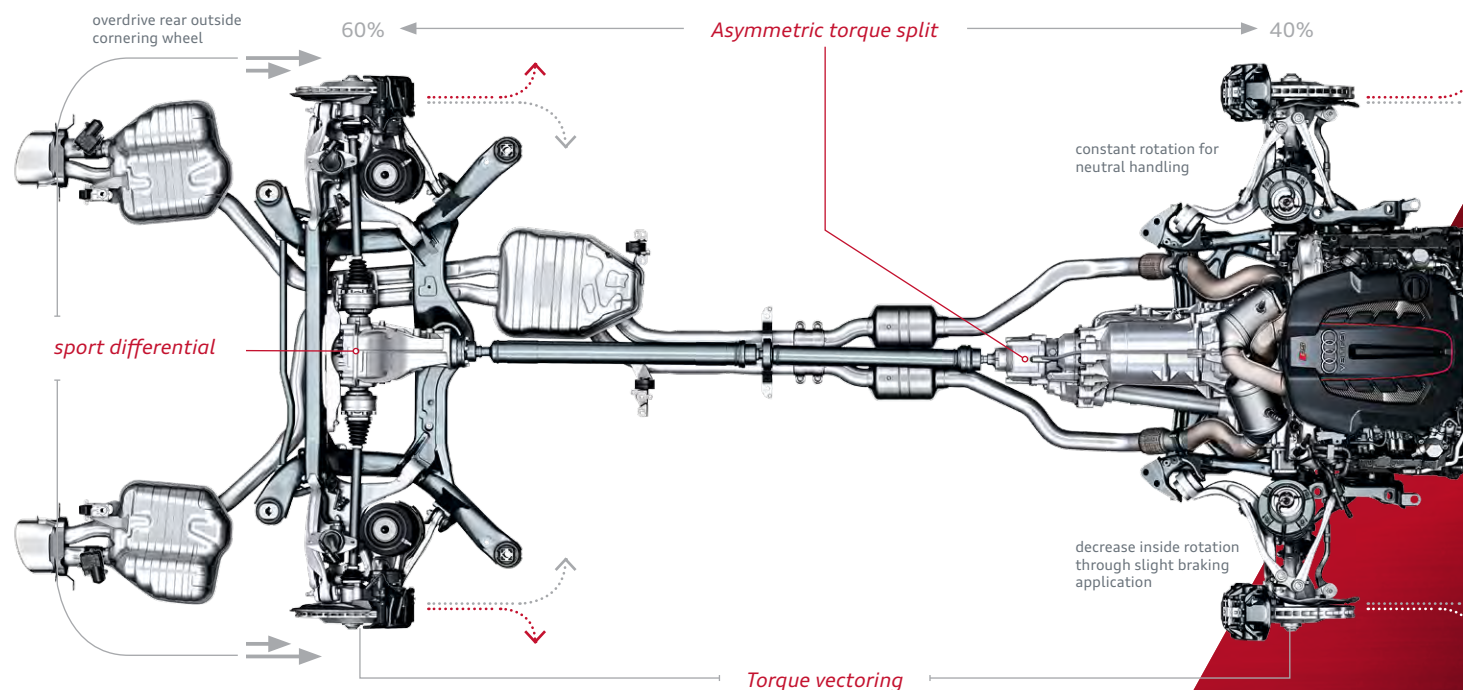

quattro® all-wheel drive with sport differential

Legendary quattro® all-wheel drive has helped win races all over the world, so just imagine what it can do in your RS 7. It starts with the system's asymmetric torque split that delivers power when and where it's most needed (up to 85% to the rear for straightaway acceleration) and gets better from there, with the addition of torque vectoring and a sport differential, which help make cornering more precise and handling more assured.

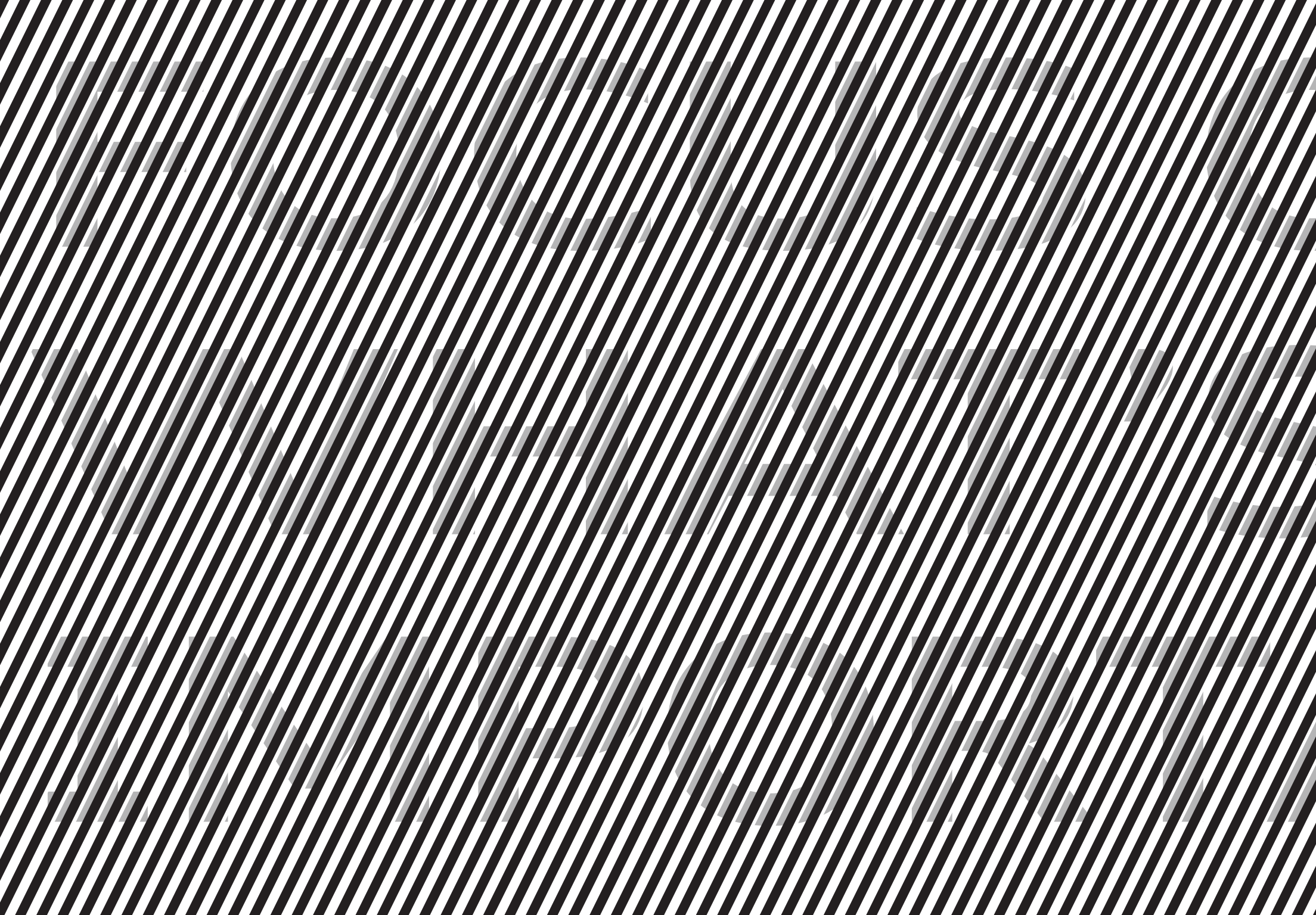



You might be missing something, but we won't.

With everything that's out there, we thought it was time to focus on what you really need to see — like that car in your blind spot, for example. Fortunately, there's a full suite of available Audi technologies that help take into account other vehicles as well as yours via intelligent driver assistance systems. These can help you focus on what's most important — the road.

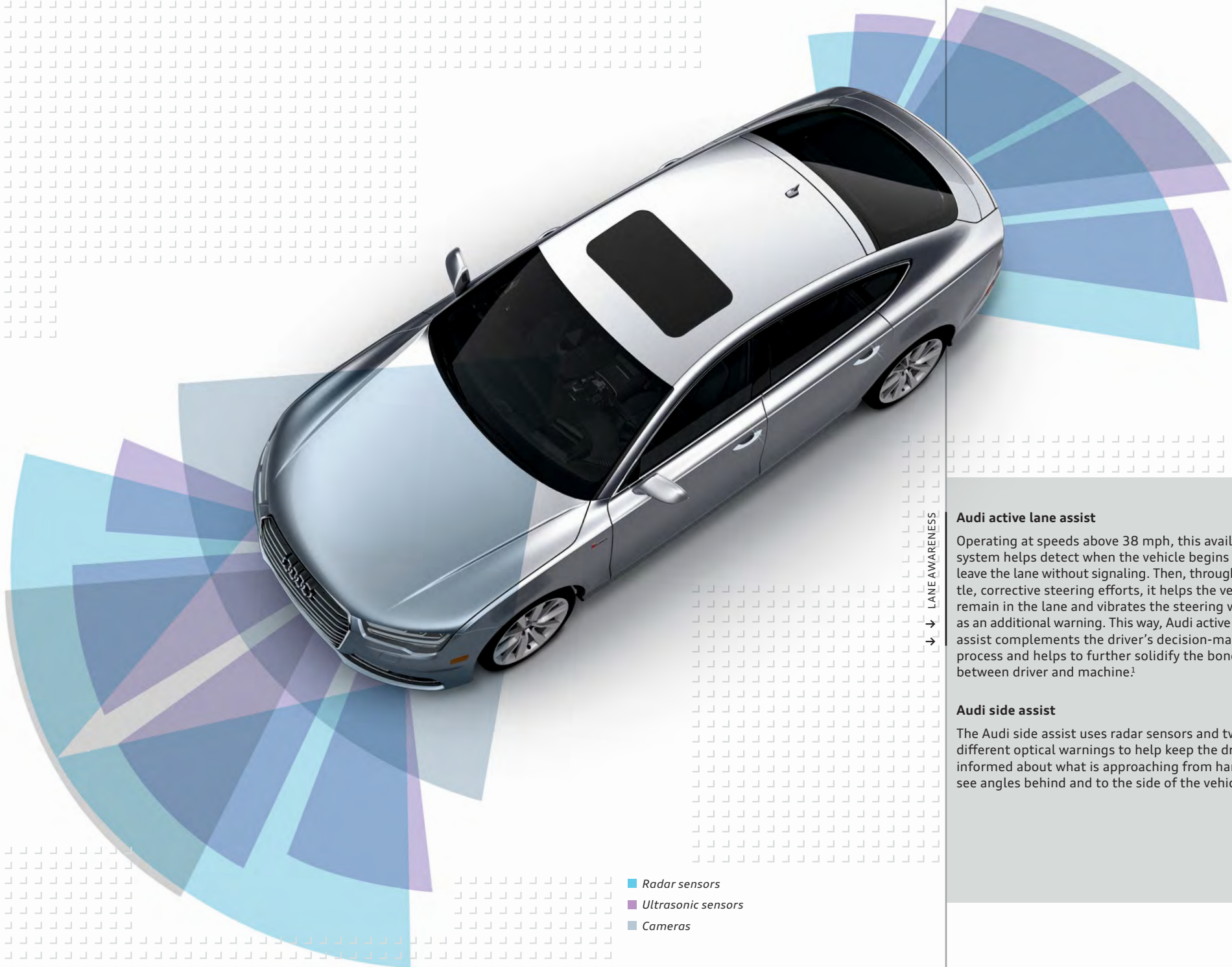

LANE AWARENESS

Audi active lane assist

Operating at speeds above 38 mph, this available system helps detect when the vehicle begins to leave the lane without signaling. Then, through gentle, corrective steering efforts, it helps the vehicle remain in the lane and vibrates the steering wheel as an additional warning. This way, Audi active lane assist complements the driver's decision-making process and helps to further solidify the bond between driver and machine.¹

Audi side assist

The Audi side assist uses radar sensors and two different optical warnings to help keep the driver informed about what is approaching from hard-to-see angles behind and to the side of the vehicle.¹

- Radar sensors
- Ultrasonic sensors
- Cameras

Senses working overtime.

There's only so much our nervous system can process at one time. Too much, and you'll feel the debilitating effects of sensory overload. We set out to combat this effect with driver assistance features designed to help lighten the sensory load. Whether it's available advanced technologies like night vision assistant, which uses infrared technology to help detect pedestrians and large animals, or Audi side assist¹ which utilizes radar sensors to help inform you of vehicles approaching from the side and rear, you'll find that we've developed them to work together to help keep you aware of your surroundings. It's just another way we like to say "We're looking out for you."

→ SITUATIONAL AWARENESS

Head-up display

With easy-to-view, accurate visual information right at eye level, this available feature displays important driving information and even pedestrian-detection warnings when equipped with the optional night vision assistant.



Corner view cameras

Giving you a nearly 360-degree view around the vehicle, the available corner view cameras help to make parking easier thanks to combined camera images from the front and rear of the vehicle.



Night vision assistant

Using infrared technology to help detect what lies ahead, this available feature uses thermal-imaging technology to help you identify trouble. Pedestrians and large animals can be detected over 300 feet in front of the vehicle, while objects can be detected over 900 feet ahead—all shown on the 7" color driver information system.

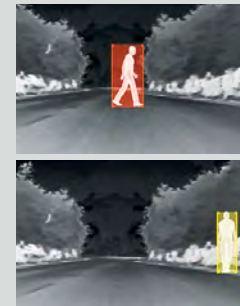

→ SEMI-AUTOMATION

Audi pre sense® plus

The available Audi pre sense plus offers comprehensive driving assistance with sensors in the front, side and rear. After visual, physical and aural collision warnings, there are four distinct phases for automatic preparation for the unavoidable: an upsurge of brake pressure, safety belt pre-tensioning, partial braking, and sunroof and window preparation. In severe cases, Audi pre sense plus will engage full braking and deceleration.¹

Audi adaptive cruise control with stop & go

Using long-range radar and a camera, the available Audi adaptive cruise control with stop & go helps read the traffic conditions and adjusts the speed, helping to bring the vehicle to a full stop before accelerating when traffic flow resumes.

¹ The features discussed are not substitutes for attentive driving. Always check surrounding traffic, and use turn signals. Please see your owner's manual for further details and important limitations.

When the right materials strike a perfect chord.

At the heart of every great performance is an equally powerful instrument. Lightweight yet strong, a violin embodies many of the qualities that make up our core engineering philosophy. Whether it's the way we bind different metals together to help form a more rigid connection or the way we shape our design for functionality and performance or even the way our crumple zones give in the right places to help dissipate energy, the similarities are present for a reason. You can't expect to perform at the highest level without a solid foundation.

Precision tuning

Efficient use of various materials

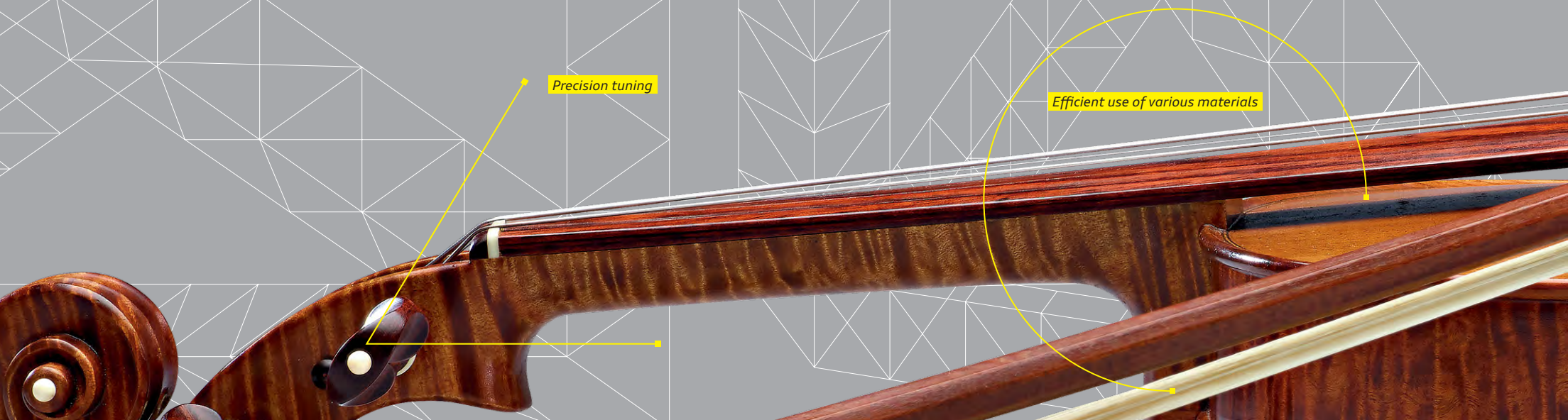



Optimal tension

Structural balance

Enduring craftsmanship

A design that helps diminish an impact is no accident.

While we don't like to make light of potential risks on the road, our engineers were tasked with doing just that. Considered a revolutionary technology, the A7 model's aluminum hybrid construction developed by Audi engineers is at the same time lightweight and resilient, offering an innovative approach to both weight savings and strength. And while you may not think about weight savings when it comes to strength, we think they go hand in hand. Complementing the advanced occupant safety cell is airbag technology designed to respond differently based on seat position, and specially constructed crumple zones that give way upon impact to help mitigate potential injury in a collision.¹ When you add all of this to the rigidity of laser seam-welded joints that enhance the strength of every Audi we make, it becomes pretty clear: helping diminish the impact of an unavoidable event doesn't happen by accident.

Ten airbags

With eight standard airbags¹, and two available ones, the A7 offers additional protection in the event of a collision. Front-impact airbags for both driver and front passenger are designed to specifically target and help protect the head during collisions, for added protection.¹

ABS and ESC

Computerized technology that works in sync with the Anti-lock Brake System (ABS), Electronic Stability Control (ESC) helps minimize loss of stability, applying brake pressure to individual wheels and reducing throttle input to help counter oversteer or understeer when the vehicle needs it.



Dramatization²

¹ Airbags are supplemental restraints only and will not deploy in all crash circumstances. Always use safety belts and refer to your owner's manual for the proper use of the restraint systems when transporting children. ² This is a dramatization and does not depict what will happen in a collision. All bags will not inflate simultaneously in real-world collisions, and, if multiple bags do deploy, they will be in various stages of inflating/deflating and will never all be inflated at the same time.

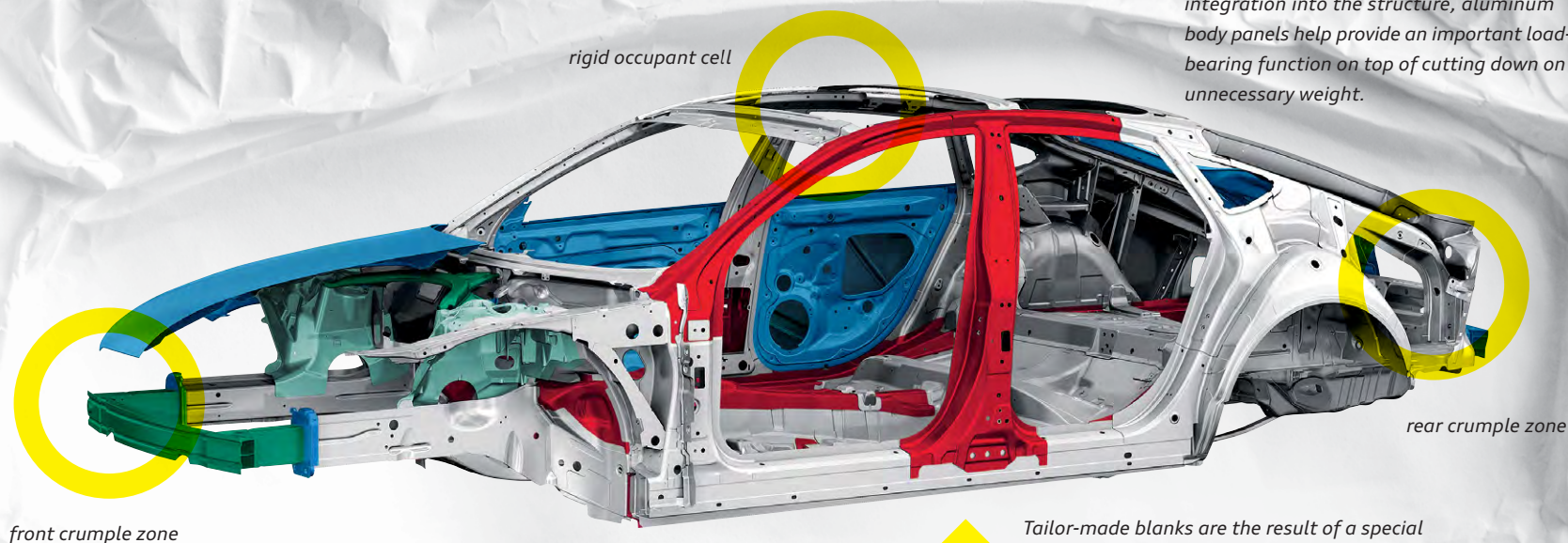

rigid occupant cell

Due to their strength and the nature of their integration into the structure, aluminum body panels help provide an important load-bearing function on top of cutting down on unnecessary weight.

front crumple zone

rear crumple zone



Tailor-made blanks are the result of a special manufacturing process that can help strengthen the upper zone of the B-pillars, while the lower zone is designed to help mitigate the impact in the event of a side collision.

- sheet aluminum
- cast aluminum
- extruded aluminum
- hot-formed steel
- cold-formed steel



It turns out, science fiction has nothing on reality.

Remember what we used to think was going to happen in the future? Flying cars, moving sidewalks and folding suitcases? While flying cars may never happen, science fiction still seems quaint compared to what reality offers. At Audi, our engineers and technicians are putting innovations in vehicles right now that would have seemed unimaginable 25 years ago. From the evolution of LED lighting technology and the introduction of dynamic steering in some models to the sheer processing power of our vehicles that allows for the seemingly infinite capabilities of Audi connect® and our MMI® with Google Voice™ integration,¹ we aren't in the business of imagining what the future will bring. We're committed to bringing it.

¹ Always pay careful attention to the road, and do not drive while distracted. The features and technologies discussed above are optional, may require an additional subscription with separate terms and conditions, and should be used only when it is safe and appropriate. The Wi-Fi® hotspot feature is intended for passenger use only.

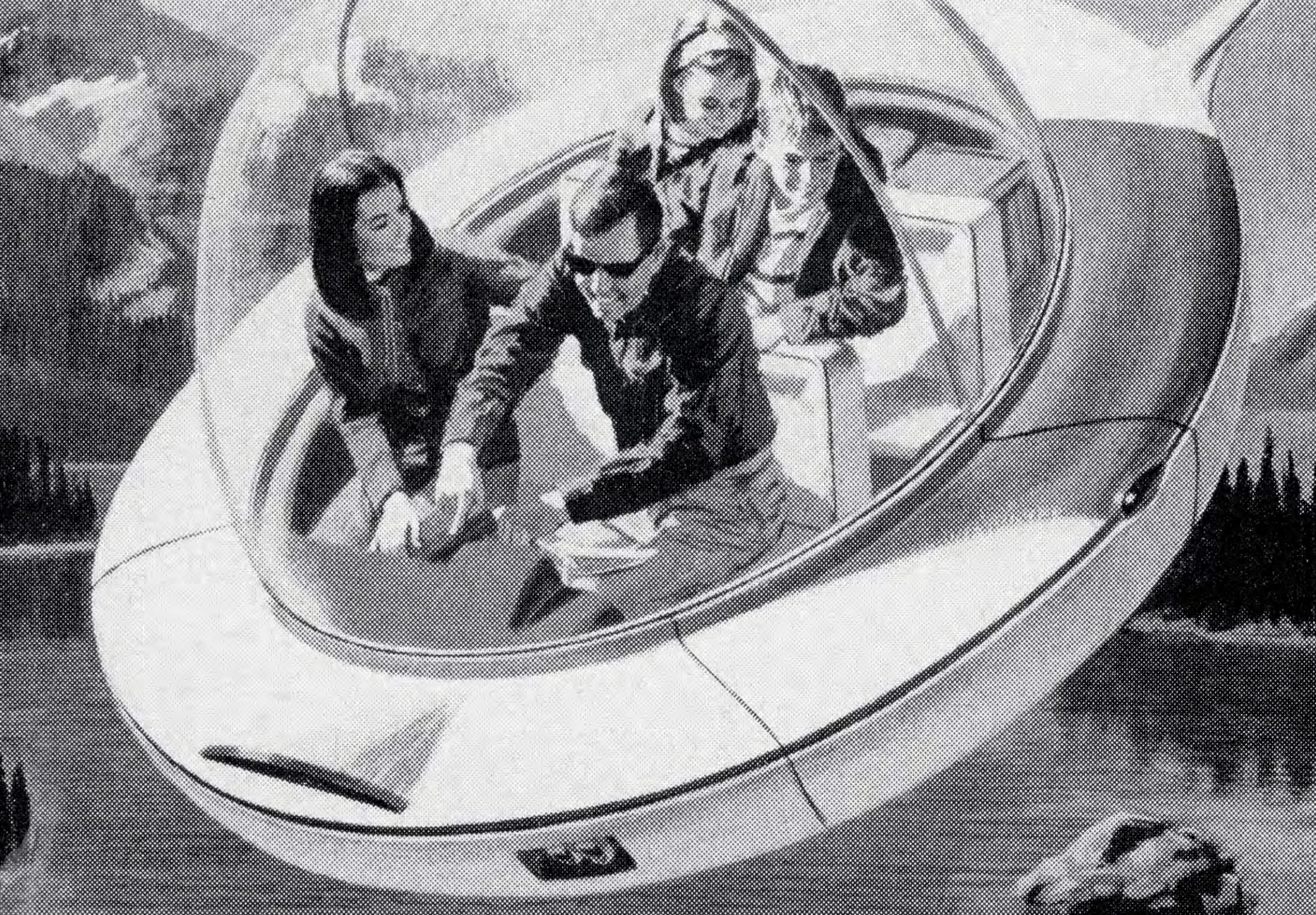

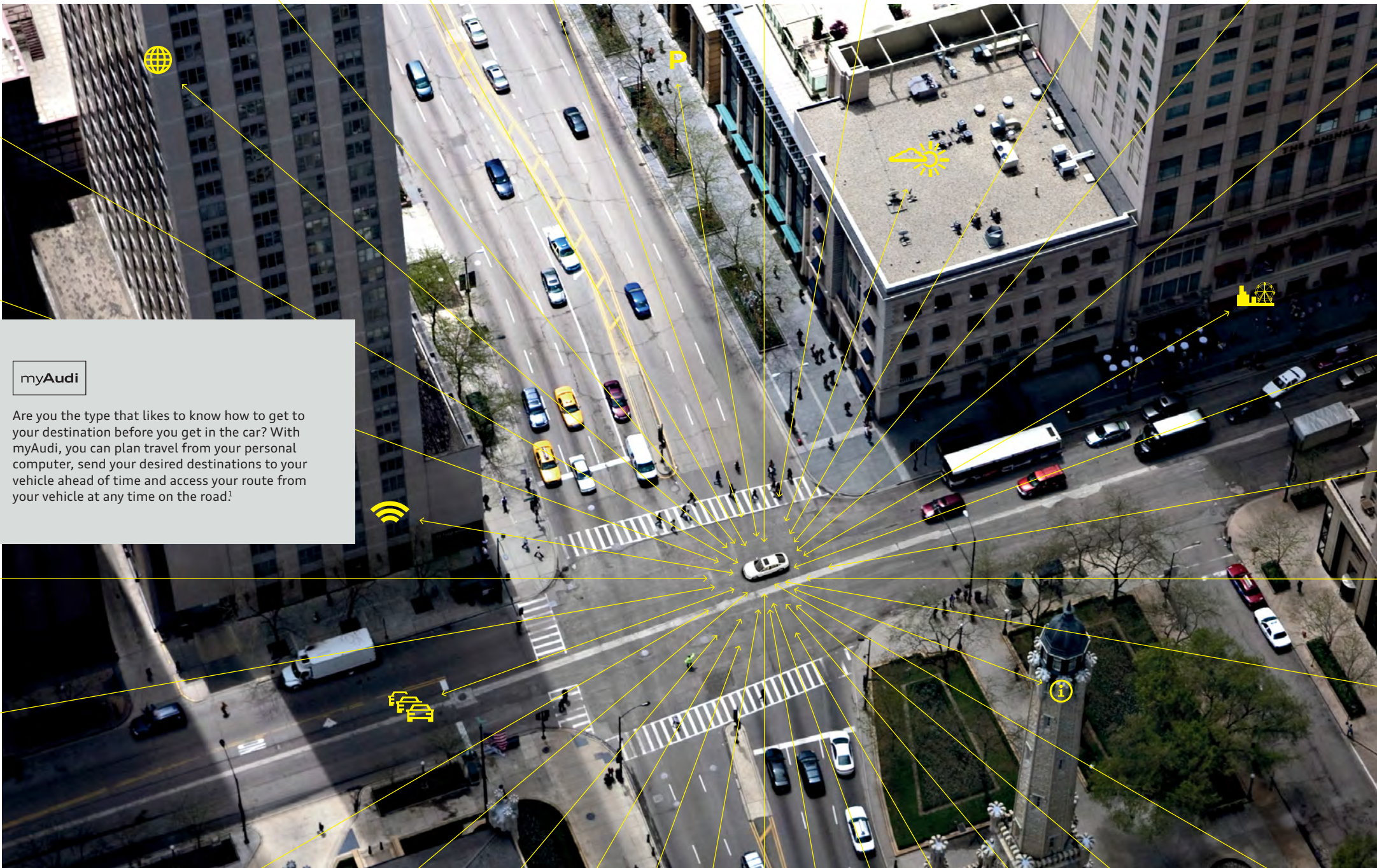

myAudi

Are you the type that likes to know how to get to your destination before you get in the car? With myAudi, you can plan travel from your personal computer, send your desired destinations to your vehicle ahead of time and access your route from your vehicle at any time on the road!

1. Always pay careful attention to the road, and do not drive while distracted. The features and technologies discussed above are optional, may require an additional subscription with separate terms and conditions, and should be used only when it is safe and appropriate. The Wi-Fi® hotspot feature is intended for passenger use only. 2. INRIX XD® Traffic is available on all Model Year 16+ A6, A7, TT and Q7 vehicles and is included with an Audi connect® subscription. Other models (allroad, A3, A4, A5, A8, Q3 and Q5) include SiriusXM® Traffic for four years with the purchase of the vehicle. 3. MMI® navigation plus depends on signals from the worldwide Global Positioning Satellite network. The vehicle's electrical system and existing wireless and satellite technologies must be available and operating properly for the system to function. The system is designed to provide you with suggested routes in locating addresses, destinations and other points of interest. Changes in street names, construction zones, traffic flow, points of interest and other road system changes are beyond the control of Audi of America, Inc. Complete detailed mapping of lanes, roads, streets, toll roads, highways, etc., is not possible, therefore you may encounter discrepancies between the mapping and your actual location. Please rely on your individual judgment in determining whether or not to follow a suggested MMI® navigation plus route. Mapping updates are available at no charge for the first five map updates and are subsequently available on a subscription basis. 4. Parking feature is not available everywhere and requires participation by parking provider.

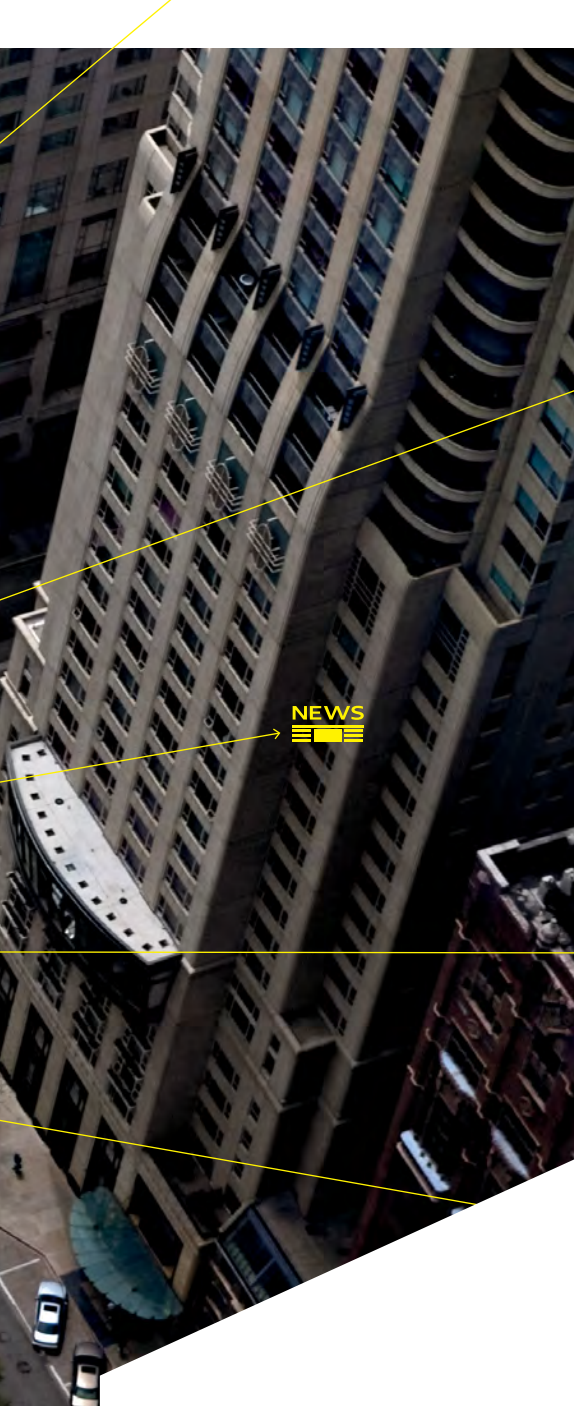

Your central command for the information age.

Sure, the handheld power of smartphones is impressive, but then, they don't handle like your Audi. Luckily, with Audi connect® you can get nearly all of the functionality of your phone, with the means to get you where you want to go.¹ Need to find a new, highly acclaimed restaurant? Pull over, and with the help of Google Voice Search™, Audi connect allows you to quickly search Google™ by simple voice commands. Looking for something to do in a new city? Get information about current events and directions to their locations. With a crisp display, a lightning-quick 4G LTE connection and easy access to steering wheel toggle controls, you have a smartcar, which can do even more than the computer in your pocket.

→ MOBILITY



With INRIX XD® Traffic, get fast and accurate traffic information (included in your active Audi connect subscription) overlaid onto 3D satellite imagery to help visualize a true aerial view of your city and highway route, and let the MMI® navigation plus system reconfigure your route to help avoid traffic.^{1,2,3}



With Google Earth™ integration, you'll enjoy 3D satellite imagery, including Google Street View™, displayed right on the MMI display¹



With Google Street View™, your Audi can show you a driver's-eye view of your destination right before you arrive so it's easy to recognize.¹



Keeping your navigation map up to date is easier than ever with the online map updates feature.¹



Search for parking in your area of interest, check space availability and set your selection as a destination to help navigate directly to the garage entrance.^{1,4}

→ TECHNOLOGY

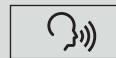

It's simple. Tell your Audi what you are in the mood for, then let the cloud-processing power of Google™ speech recognition interpret your request and bring up a list of destinations in the area of your choice.¹



Staying connected in your Audi has never been easier, with in-vehicle high-speed 4G LTE connectivity. Access is provided for up to eight passenger devices through an onboard wireless hub.¹



The point-of-interest search with voice control means that you can get the most out of every journey.¹



With streaming audio, it's easier than ever to stream music from your phone or digital music player right to the vehicle's audio system.¹



With access to Facebook® and Twitter® you'll always know what's going on with your friends, family and the world.¹

→ INFORMATION



Get information about current events, exciting locations and places of interest at your travel destination, current location or other chosen location instantly.¹



Stay on top of the news by having headlines and stories delivered right to your MMI display.¹



With current local weather conditions and forecasts for your destination, you'll always be prepared for your trip.¹



Discover travel information for local landmarks in your area of interest, set them as your destinations and let your vehicle lead the way as you explore the world around you.¹



With up-to-the-minute flight information available on your MMI screen, you'll know if your flight is on time.¹

Redefining the all-access pass.

Going backstage just got a lot more immersive, and intuitive. The intelligent MMI® system offers a wealth of easily accessible information with a unique twist, or, technically, a touch. Considered a revolution in intelligent simplicity, MMI touch with handwriting recognition is a technology that helps give you the ability to give commands and retrieve media with just a few simple strokes on the pad. You'll quickly have access to information such as music files, contact information and destinations. The possibilities are even bigger when you input to Audi connect®, an innovative infotainment system infused with the power of Google™ technology.¹ With this kind of access, you could say there is no greater stage.

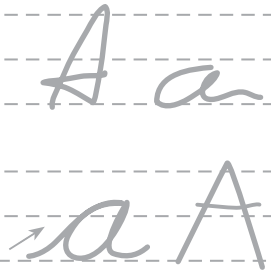

MMI touch

Developed by the Audi Human Machine Interface (HMI) team, MMI touch illustrates why making something simple to use can be so complex. The HMI team designed a system so advanced, it can read almost anyone's handwriting — even if you choose to write with your non-dominant hand.

Audi media

The media function opens up a world of options with the MMI navigation plus, allowing you to control the Audi music interface through two USB ports, Secure Digital (SD) card slots, hard disk drive (HDD) audio jukebox or DVD, and BLUETOOTH® streaming audio from a compatible device.²

SiriusXM® Satellite Radio

Go ahead. Crisscross the country. We assure you, you'll never run out of entertainment options, with over 150 channels of music, talk, sports and news.²

MMI navigation plus

Count on the advanced navigation system to help home in on your destination with stunning precision while putting a little more Earth™ depth in your journey with help from Google Earth™.²

BLUETOOTH® wireless technology

Unlock your compatible mobile phone's potential through the MMI system. Simply pair them up and start enjoying near complete control at the touch of a button.²

Quad-core processing power

Designed to elevate your automotive experience, the NVIDIA® quad-core Tegra® 3 processor powers the MMI system for lightning-fast response and seamless functionality.

¹ Always pay careful attention to the road, and do not drive while distracted. The features and technologies discussed above are optional, may require an additional subscription with separate terms and conditions, and should be used only when it is safe and appropriate. The Wi-Fi® hotspot feature is intended for passenger use only. ² See pages 44–47 for important information regarding Audi connect®, MMI® navigation plus, required compatible device and required SiriusXM® subscriptions.



STOP

G

⏮

⏭

NAV

TEL

MENU

BACK ↶

CAR

RADIO

MEDIA

Orchestrate a more thrilling drive.

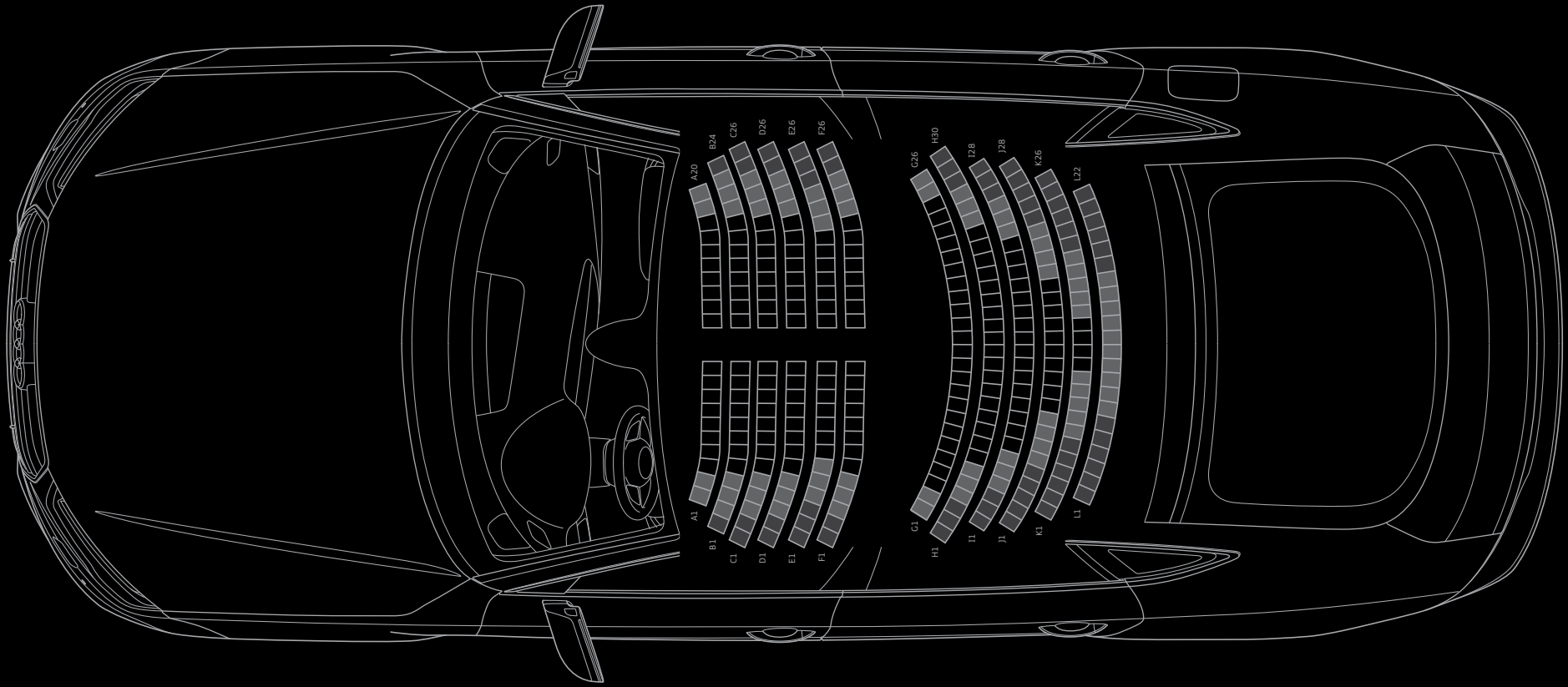

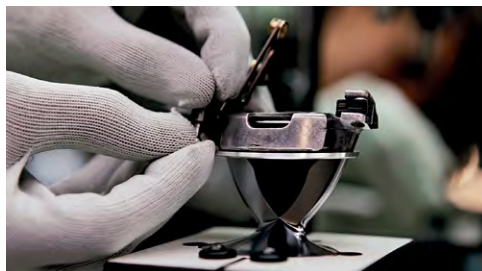

*Over 400 hours of sound tuning
Tested 54,000 times
at speeds up to 155 mph*

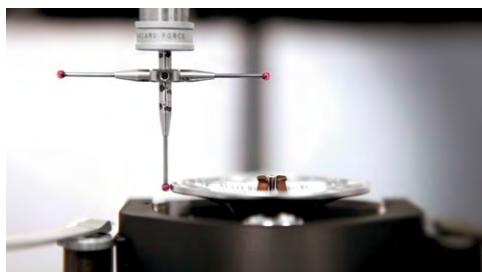
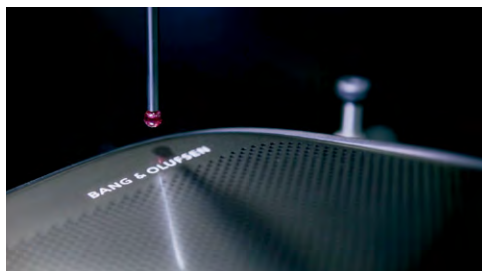
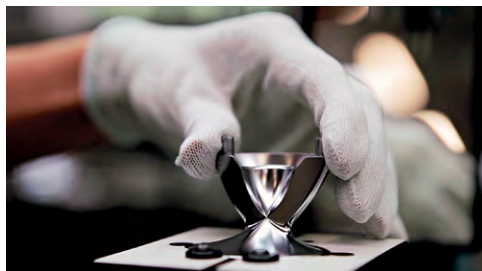

When we set out to compose the most advanced sound system we've ever assembled, we didn't want you to just *hear* every note. We wanted you to *experience* them. From perfectly sculpted high notes to a crystal clear mid-range to deep-diving lows, the available Bang & Olufsen® Advanced Sound System delivers a stunning recreation of sound that you can feel as much as hear. Innovative sound engineering can also be found in the available BOSE® Surround Sound System, which effortlessly brings a performance to life. So whether you're in the mood to be soothed, engaged or inspired, you can expect an immersive experience that can only be matched by the exhilaration of driving your Audi.

Bang & Olufsen® Advanced Sound System

The passion of Bang & Olufsen® matches well with Audi. Just consider the remarkable available Bang & Olufsen® Advanced Sound System. A synthesis of design and performance, it has become the symbol of acoustic perfection. Bang & Olufsen® engineers help to craft meticulously rendered sound through 15 speakers (including two innovative retractable aluminum acoustic lenses) and an impressive 1,300 watts through the sealed speaker cabinets and BeoCore amplifiers.

BOSE® Surround Sound System

Hitting the right note on every drive, the available BOSE® Surround Sound System turns your Audi into a 14-speaker powerhouse with the help of innovative sound engineering and optimized speaker placement. Add to that AudioPilot® noise compensation, which helps maintain a consistent volume under varying speeds and road conditions, and you get an acoustic listening environment that rivals any live performance.



2016 Audi S7 shown in Moonlight Blue metallic with available equipment.

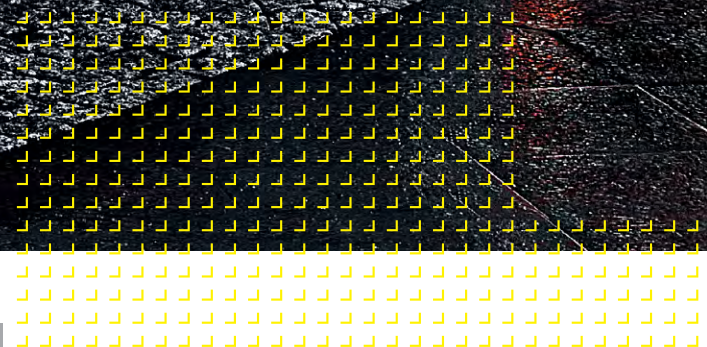



The boldly sophisticated Audi S7 commands attention in any environment. A testament to its inspiring design.

A7

3.0T and TDI® Premium Plus



A7 Premium Plus Featured highlights

Infotainment/Technology

- > MMI® navigation plus with voice control system and MMI® touch with handwriting-recognition technology¹
- > Audi connect® with six-month trial subscription²
- > 7" color driver information system
- > MMI® radio plus with ten speakers and single CD player with MP3 playback capability
- > HD Radio™ Technology
- > SiriusXM® Satellite Radio with 90-day trial subscription³
- > INRIX XD® Traffic⁴
- > SD card slot with 32GB operating capacity (dual slots)
- > Audi music interface (two USB ports)
- > BLUETOOTH® streaming audio for compatible devices
- > BLUETOOTH® wireless technology preparation for compatible mobile phones
- > Garage door opener (HomeLink®)
- > Audi advanced key—keyless start, stop and entry⁵
- > Audi side assist with Audi pre sense® rear⁶
- > Audi drive select
- > Parking system plus with rear view camera (front and rear sensors)

Exterior

- > 19" 5-spoke-V design with all-season tires
- > Full LED headlights
- > LED taillights and rear fog lights
- > Power-adjustable, power-folding, auto-dimming, heated exterior side mirrors with memory
- > Heated windshield washer nozzles
- > Power tailgate with hands-free release
- > Adaptive rear spoiler
- > Integrated twin-trapezoidal exhaust outlets

Interior/Seating

- > Four-zone automatic climate control
- > Three-spoke multifunction steering wheel with shift paddles
- > Power tilt and telescopic adjustable steering column
- > Fine Grain Ash Natural Brown Wood decorative inlays
- > Leather seating surfaces
- > Heated eight-way power front seats and four-way power lumbar adjustment and memory for driver
- > Split folding 60/40 rear seatbacks with pass-through
- > Sunroof

Safety

- > Driver and front passenger dual-stage airbags, front thorax side airbags, knee airbags, and Sideguard® head curtain airbags⁷
- > Front passenger occupant detection-for airbags⁷
- > Lower Anchors and Tethers for Children (LATCH) in rear seats
- > Electronic Stability Control (ESC) with secondary collision brake assist and traction control (ASR)
- > Anti-lock Brake System (ABS) with Electronic Brake-pressure Distribution (EBD) and brake assist
- > Tire-pressure monitoring system
- > Electromechanical parking brake

A7 Premium Plus Stand-alone options

- > 20" 5-spoke-W design wheels (Silver/Black finish)
- > 20" 265/35 summer performance tires⁸
- > Rear-passenger thorax side airbags⁷
- > Dark Brown Walnut Wood decorative inlays
- > Layered Walnut Wood decorative inlays
- > BOSE® Surround Sound System with 14 speakers, AudioPilot® noise-compensation and 630 watts

A7 Premium Plus Available Packages

20" Wheel package

- > 20" 5-spoke-W design wheels (Gray/Polished finish)
- > 265/35 all-season tires⁸

Cold Weather package

- > Heated steering wheel
- > Heated rear seats

S line® Sport package

- > S line® exterior appearance
- > Sport suspension calibration
- > Audi Sport® 19" 7-twin-spoke design wheels (Galvano Silver finish)
- > 255/40 all-season tires⁸
- > Aluminum door sill inlays (with S line® badging)

Driver Assistance package

- > Audi adaptive cruise control with stop & go
- > Audi active lane assist⁶
- > Audi pre sense® plus⁶
- > Corner view camera system
- > High-beam assistant

Black Optic package

- > Audi Sport® 5-twin-spoke design wheels (Titanium-matte finish) or optional 20" 5-spoke-W design wheels (Silver/Black finish)
- > 265/35 all-season tires⁸
- > Gloss Black Singleframe® grille
- > Gloss Black trim around exterior windows

¹ MMI® navigation plus depends on signals from the worldwide Global Positioning Satellite network. The vehicle's electrical system and existing wireless and satellite technologies must be available and operating properly for the system to function. The system is designed to provide you with suggested routes in locating addresses, destinations and other points of interest. Changes in street names, construction zones, traffic flow, points of interest and other road system changes are beyond the control of Audi of America, Inc. Complete detailed mapping of lanes, roads, streets, toll roads, highways, etc., is not possible, therefore you may encounter discrepancies between the mapping and your actual location. Please rely on your individual judgment in determining whether or not to follow a suggested MMI® navigation plus route. Mapping updates are available at no charge for the first five map updates and are subsequently available on a subscription basis. ² Always pay careful attention to the road, and do not drive while distracted. The features and technologies discussed above are optional, may require an additional subscription with separate terms and conditions, and should be

A7

3.0T and TDI® Prestige



A7 Prestige Featured highlights



In addition to or replaces highlighted features of A7 Premium Plus

Infotainment/Technology

- > BOSE® Surround Sound System with 14 speakers, AudioPilot® noise-compensation and 630 watts
- > Head-up display with navigation information

Interior

- > Ambient LED interior lighting
- > Ventilated twelve-way power front seats, including four-way power lumbar adjustment

A7 Prestige Stand-alone options

- > 20" 5-spoke-W design wheels (Silver/Black finish)
- > 20" 265/35 summer performance tires⁸
- > Rear-passenger thorax side airbags⁷
- > Power soft-closing doors
- > Dark Brown Walnut Wood decorative inlays
- > Layered Walnut Wood decorative inlays
- > Bang & Olufsen® Advanced Sound System with 15 speakers and 1,300 watts
- > Night vision assistant with pedestrian and large animal detection

A7 Prestige Available packages

20" Wheel package

- > 20" 5-spoke-W design wheels (Gray/Polished finish)
- > 265/35 all-season tires⁸

Cold Weather package

- > Heated steering wheel
- > Heated rear seats

S line® Sport package

- > S line® exterior appearance
- > Sport suspension calibration
- > Audi Sport® 19" 7-twin-spoke design wheels (Galvano Silver finish)
- > 255/40 all-season tires⁸
- > Aluminum door sill inlays (with S line® badging)

Driver Assistance package

- > Audi adaptive cruise control with stop & go
- > Audi active lane assist⁶
- > Audi pre sense® plus⁶
- > Corner view camera system
- > High-beam assistant

Black Optic package

- > Audi Sport® 5-twin-spoke design wheels (Titanium-matte finish) or optional 20" 5-spoke-W design wheels (Silver/Black finish)
- > 265/35 all-season tires⁸
- > Gloss Black Singleframe® grille
- > Gloss Black trim around exterior windows

Individual Contour Seating package

- > Heated and ventilated 18-way power individual contour comfort front seats, including four-way power lumbar adjustment and massage function
- > Valcona leather seats
- > Front passenger seat memory

Cedar Brown Audi design selection

- > Cedar Brown Valcona leather seats
- > Heated and ventilated 18-way power individual contour comfort front seats, including four-way power lumbar adjustment and massage function
- > Layered Aluminum/Walnut Wood decorative inlays
- > Interior leather package (including leather-wrapped door armrests, steering wheel airbag cap, and lower center console)

used only when it is safe and appropriate. The Wi-Fi® hotspot feature is intended for passenger use only. ³ SiriusXM Satellite Radio and SiriusXM Traffic subscriptions are sold separately or as a package after trial period and are continuous until you call SiriusXM to cancel. See Customer Agreement for complete terms and more information at www.siriusxm.com. SiriusXM Traffic service available in select markets. SiriusXM U.S. Satellite Service available only to those in the 48 contiguous U.S.A., D.C. and Puerto Rico (with coverage limitations). ⁴ INRIX XD® Traffic is available on all Model Year 16+ A6, A7, TT and Q7 vehicles and is included with an Audi connect® subscription. Other models (allroad, A3, A4, A5, A8, Q3 and Q5) include SiriusXM® Traffic for four years with the purchase of the vehicle. ⁵ Some Audi models are equipped with a keyless ignition feature. The details as to how the system works can vary, and Audi owners should consult their owner's literature or an authorized Audi dealer if they have further questions about the operation of this feature. Please note that Audi warns against leaving the vehicle unattended with the engine running, particularly in enclosed spaces. ⁶ The features discussed are not substitutes for attentive driving. Always check surrounding traffic, and use turn signals. Please see your owner's manual for further details and important limitations. ⁷ Airbags are supplemental restraints only and will not deploy in all crash circumstances. Always use safety belts and refer to your owner's manual for the proper use of the restraint systems when transporting children. ⁸ High-performance tires are designed for better performance and handling in warm climates. When driving in cold, snowy or icy weather, you should equip your vehicle with four all-season or winter tires, which offer better traction under those conditions. We suggest you use the Audi-recommended winter or all-season tires specified for your Audi. High-performance tires also have a lower aspect ratio that aids performance and handling. Driving over rough or damaged road surfaces, as well as debris, curbs and other obstacles, can cause serious damage to wheels, tires, vehicle body and suspension parts. Be careful to avoid road hazards and reduce your speed, especially if your vehicle is equipped with low-profile tires. Please also remember when making your selection that, while these tires deliver responsive handling, they may ride less comfortably and make more noise than others. Finally, these tires may wear more quickly than other choices. It is important that the inflation pressure is regularly checked and maintained at recommended levels.

S7



S7 Featured highlights



In addition to or replaces highlighted features of A7 Prestige

Engineering/Performance

- > 4.0-liter TFSI® turbocharged V8
- > 450 hp/406 lb-ft torque
- > cylinder on demand™ engine efficiency technology¹
- > Acceleration (0–60 mph) in 4.5 seconds
- > Top track speed of 155 mph²

Transmission/Suspension/Chassis

- > Seven-speed S tronic® dual-clutch transmission
- > Audi adaptive air suspension (with S model-specific tuning)
- > 15.7" ventilated front disc/14.0" ventilated rear disc brakes (with S7 badging)

Exterior

- > Platinum Gray Singleframe® grille
- > S model-specific front/rear fasciae and side sills
- > Aluminum-optic front/rear twin blades
- > Aluminum-optic exterior side mirror housings
- > S model quad exhaust outlets

Interior/Seating

- > Three-spoke multifunction flat-bottom sport steering wheel with shift paddles (with S7 badging)
- > Fine Grain Ash Natural Brown Wood decorative inlays
- > Aluminum door sill inlays (with S7 badging)
- > Valcona leather seats with contrast diamond-stitching (with S7 model designation)
- > Twelve-way power front sport-contoured seats, including four-way power lumbar adjustment
- > Leather-wrapped door armrests
- > Four-seat configuration

S7 Stand-alone options

- > 20" 5-parallel-spoke star S design wheels with 265/35 summer performance tires³
- > Rear-passenger thorax side airbags⁴
- > Power soft-closing doors
- > Carbon Atlas decorative inlays
- > Layered Aluminum/Black Wood decorative inlays
- > Black Alcantara® headliner
- > Bang & Olufsen® Advanced Sound System with 15 speakers and 1,300 watts
- > Night vision assistant with pedestrian and large animal detection

S7 Available packages

Cold Weather package

- > Heated steering wheel (deletes flat-bottom steering wheel)
- > Heated rear seats

S7 Sport package

- > quattro® sport differential
- > Dynamic steering
- > Sport exhaust system with Black outlets

Black Optic or 21" Black Optic package

- > Audi Sport® 20" 5-twin-spoke design (Titanium-matte finish) or optional Audi Sport® 21" 5-arm-rotor design wheels (Titanium-matte finish)
- > 20" 265/35 or optional 21" 275/30 summer performance tires³
- > Gloss Black Singleframe® grille
- > Gloss Black trim around exterior windows
- > Body-colored exterior side mirror housings

Driver Assistance package

- > Audi adaptive cruise control with stop & go
- > Audi active lane assist⁵
- > Audi pre sense plus⁵
- > Corner view camera system
- > High-beam assistant

Individual Contour Seating package

- > Heated and ventilated 18-way power individual contour comfort front seats, including four-way power lumbar adjustment and massage function
- > Valcona leather seats (without contrast diamond stitching)
- > Front passenger seat memory

Arras Red Audi design selection

- > Arras Red Valcona leather seats with contrast diamond stitching
- > Carbon Twill, Red decorative inlays
- > Granite Gray contrast stitching
- > Black cloth headliner

¹ EPA estimates. Your mileage will vary and depends on several factors, including your driving habits and vehicle condition. See www.fueleconomy.gov for details. ² Top track speed is electronically limited in the U.S. Always obey all speed and traffic laws. ³ High-performance tires are designed for better performance and handling in warm climates. When driving in cold, snowy or icy weather, you should equip your vehicle with four all-season or winter tires, which offer better traction under those conditions. We suggest you use the Audi-recommended winter or all-season tires specified for your Audi. High-performance tires also have a lower aspect ratio that aids performance and handling. Driving over rough or damaged road surfaces, as well as debris, curbs and other obstacles, can cause serious damage to wheels, tires, vehicle body and suspension parts. Be careful to avoid road hazards and reduce your speed, especially if your vehicle is equipped with low-profile tires. Please also remember when making your selection that, while these tires deliver responsive handling, they may ride less comfortably and make more noise than others. Finally, these tires may wear more quickly than other choices. It is important that the inflation pressure is regularly checked and maintained at recommended levels. ⁴ Airbags are supplemental restraints only and will not deploy in all crash circumstances. Always use safety belts and refer to your owner's manual for the proper use of the restraint systems when transporting children. ⁵ The features discussed are not substitutes for attentive driving. Always check surrounding traffic, and use turn signals. Please see your owner's manual for further details and important limitations. ⁶ 2016 EPA estimates not available at time of publication. See www.fueleconomy.gov for updated information. Your mileage will vary and depends on several factors, including your driving habits and vehicle condition. ⁷ Carbon Optic packages with Mythos Black metallic or Panther Black crystal have body-colored exterior side mirror housings.



RS 7 Featured highlights



In addition to or replaces highlighted features of A7 Prestige

Engineering/Performance

- > 4.0-liter TFSI® turbocharged V8
- > 560 hp/516 lb-ft torque
- > cylinder on demand™ engine efficiency technology⁶
- > Acceleration (0–60 mph) in 3.7 seconds
- > Top track speed of 174 mph²

Suspension/Chassis

- > quattro® sport differential
- > Audi adaptive air suspension (with RS model-specific tuning)
- > 15.4 ventilated wave-design front disc/14.0 ventilated wave-design rear disc brakes
- > Dynamic steering

Exterior

- > RS exclusive Singleframe® grille with honeycomb mesh inserts
- > RS model unique front/rear fasciae and side sills
- > Matte aluminum exterior side mirror housings
- > Matte aluminum trim around exterior windows
- > RS model oval exhaust outlets

Interior/Seating

- > Three-spoke multifunction flat-bottom sport steering wheel with shift paddles (with RS 7 badging)
- > RS-design Carbon Fiber decorative inlays
- > Aluminum door sill inlays (with RS 7 badging)
- > Valcona leather seats with contrast honeycomb-stitching (with RS model designation)
- > Twelve-way power front sport-contoured seats, including four-way power lumbar adjustment
- > Leather-wrapped door armrests
- > Four-seat configuration

RS 7 Stand-alone options

- > Audi Sport® 21" 5-spoke-blade design wheels with 275/30 summer performance tires³
- > Audi Sport® 21" 5-spoke-blade design (Titanium-matte finish) with 275/30 summer performance tires³
- > Audi Sport® 21" 5-spoke-blade design (Black finish) with 275/30 summer performance tires³
- > Rear-passenger thorax side airbags⁴
- > Body-colored exterior side mirror housings
- > Power soft-closing doors
- > Sport exhaust system with Black outlets
- > Black Alcantara® headliner
- > Layered Aluminum/Black Wood decorative inlays
- > Aluminum Race decorative inlays
- > Bang & Olufsen® Advanced Sound System with 15 speakers and 1,300 watts
- > Night vision assistant with pedestrian and large animal detection

RS 7 Available packages

Cold Weather package

- > Heated steering wheel (deletes flat-bottom steering wheel)
- > Heated rear seats

Driver Assistance package

- > Audi adaptive cruise control with stop & go
- > Audi active lane assist⁵
- > Audi pre sense® plus⁵
- > Corner view camera system
- > High-beam assistant

Individual Contour Seating package

- > Heated and ventilated 18-way power individual contour comfort front seats, including four-way power lumbar adjustment and massage function
- > Valcona leather seats (without contrast honeycomb stitching)
- > Front passenger seat memory

RS 7 Dynamic package

- > DRC® suspension system (replaces Audi adaptive air suspension)
- > Red brake calipers
- > Sport exhaust system with Black outlets

Matte Aluminum Optic package

- > Matte Aluminum-optic front spoiler, lower air intakes and rear diffuser
- > Available with or without Singleframe® grille “quattro” script

Carbon Optic package

- > Carbon fiber front spoiler and rear diffuser
- > Gloss Black exterior side mirror housings⁷
- > Gloss Black Singleframe® grille
- > Available with or without Singleframe® grille “quattro” script
- > Gloss Black trim around exterior windows

A shade more extraordinary.

Audi exclusive is an exercise in self-expression. It's a commission of your own personal tastes. A premium option for an exceptionally premium vehicle, Audi exclusive gives you the chance to put an unmistakably personal stamp on your vehicle by offering an almost limitless spectrum of Audi exclusive paint colors, special exclusive decorative inlays and exclusive leather options. Choose the shades, materials and even the stitching that moves you the most and make your vehicle as extraordinary as you are.

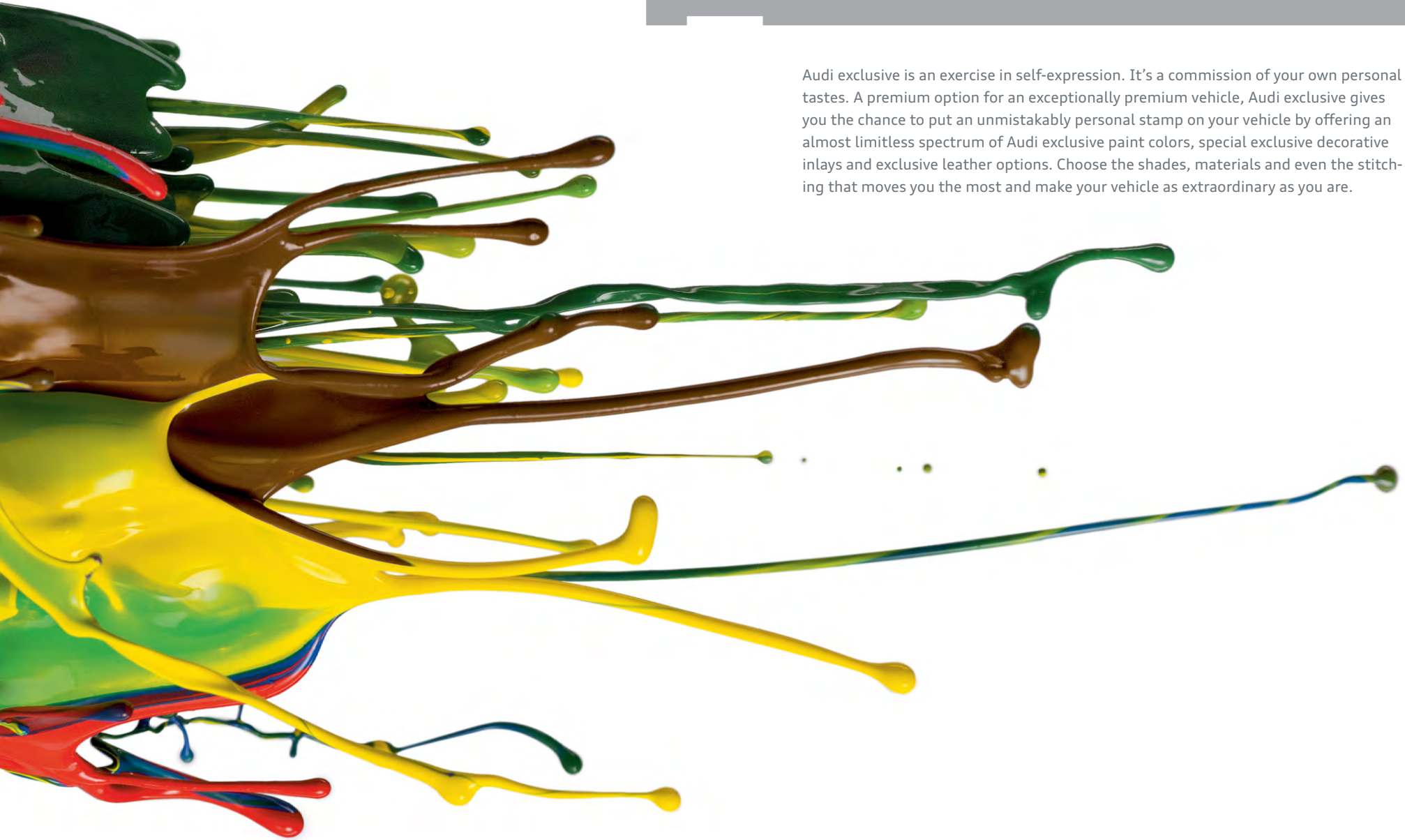



Decorative Inlays

A7

Fine Grain Ash Natural Brown Wood

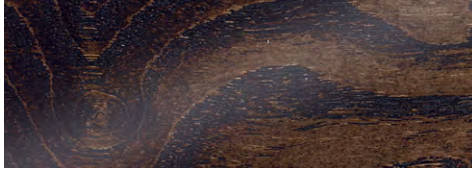

Standard

Dark Brown Walnut Wood



Optional

Layered Walnut Wood



Optional

Layered Aluminum/Walnut Wood



Cedar Brown Audi design selection

S7

Fine Grain Ash Natural Brown Wood

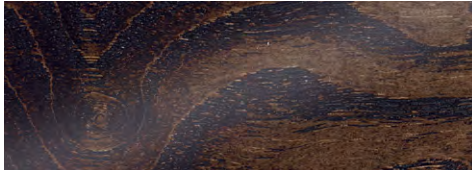

Standard

Carbon Atlas

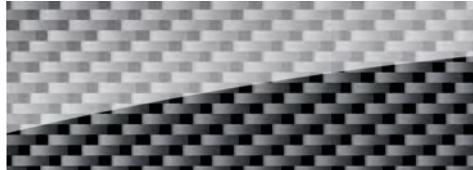

Optional

Layered Aluminum/Black Wood



Optional

Carbon Twill, Red

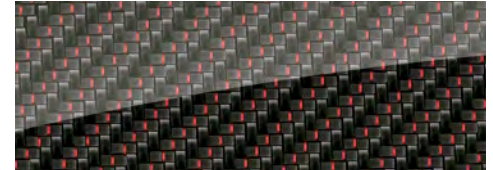

Arras Red Audi design selection

RS 7

RS-design Carbon Fiber

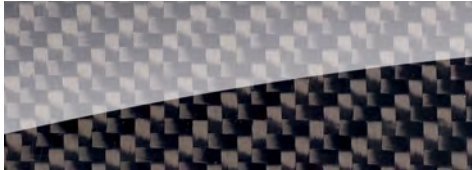

Standard

Layered Aluminum/Black Wood



Optional

Aluminum Race



Optional

Audi exclusive

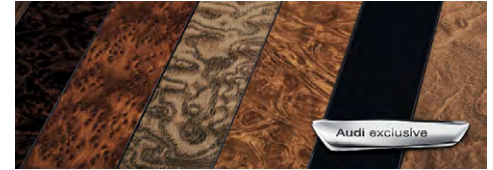

Available on all A7 family of vehicles

A7

19" 5-spoke-V design



Standard

Audi Sport® 19" 7-twin-spoke design
(Galvano Silver finish)

S line® Sport package

20" 5-spoke-W design
(Gray/Polished finish)

20" Wheel package

Audi Sport® 20" 5-twin-spoke design
(Titanium-matte finish)

Black Optic package

20" 5-spoke-W design
(Silver/Black finish)

Optional, Black Optic package

S7

19" 5-parallel-spoke S design



Standard

20" 5-parallel-spoke star S design



Optional

Audi Sport® 20" 5-twin-spoke design
(Titanium-matte finish)

Black Optic package

Audi Sport® 21" 5-arm-rotor design
(Titanium-matte finish)

21" Black Optic package

RS 7

20" 7-twin-spoke design



Standard

Audi Sport® 21" 5-spoke-blade design



Optional

Audi Sport® 21" 5-spoke-blade design
(Titanium-matte finish)

Optional

Audi Sport® 21" 5-spoke-blade design
(Black finish)

Optional

Exterior Colors

Brilliant Black



A7, S7

Ibis White



A7, S7

Nardo Gray

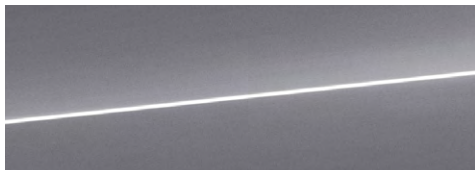

RS 7

Cuvée Silver metallic

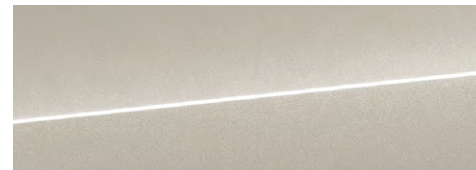

A7

Dakota Gray metallic



A7

Florett Silver metallic

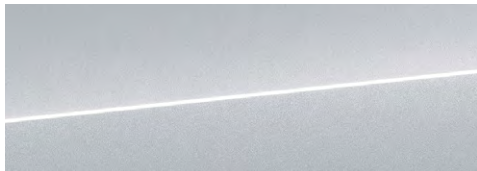

A7, S7, RS 7

Glacier White metallic



A7, S7, RS 7

Havana Black metallic

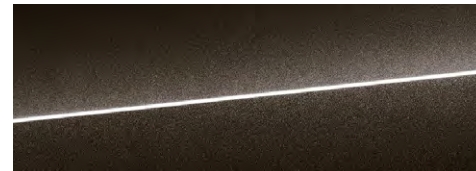

A7, S7

Moonlight Blue metallic

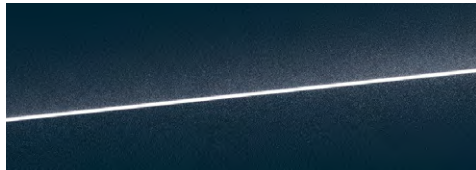

A7, S7

Mythos Black metallic



A7, S7, RS 7

Oolong Gray metallic



A7, S7

Tornado Gray metallic

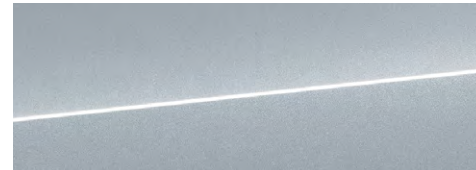

A7, S7

Daytona Gray pearl



S7, RS 7

Misano Red pearl



S7, RS 7

Sepang Blue pearl

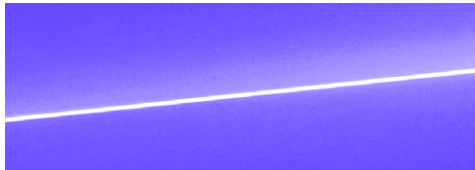

S7, RS 7

Panther Black crystal

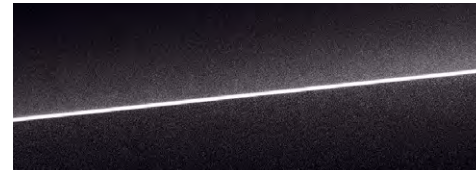

RS 7

Prism Silver crystal



RS 7

Daytona Gray matte



RS 7

Audi exclusive



Available on all A7 family of vehicles

Exterior colors, interior colors and decorative inlay options will vary based on model, trim level and package combination. See your dealer for details.

Interior Colors and Seat Selections

A7

Black leather

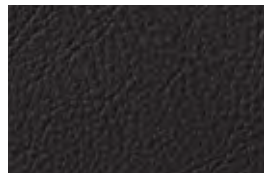

Nougat Brown leather

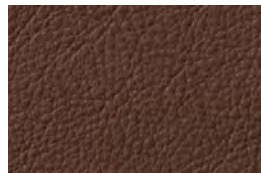

Flint Gray leather

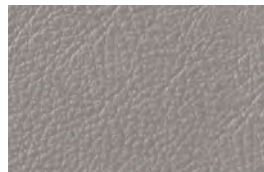

Atlas Beige leather

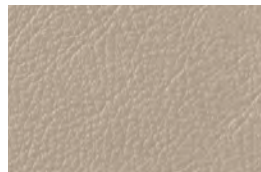

Black Perforated leather



Nougat Brown Perforated leather

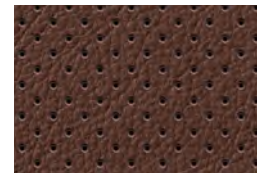

Flint Gray Perforated leather

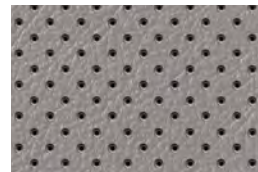

Atlas Beige Perforated leather



S7

S7 Sport Seat



Black Valcona leather with Silver contrast diamond stitching



Lunar Silver Valcona leather with Graphite Gray contrast diamond stitching

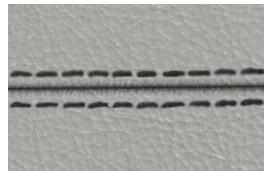

Arras Red Valcona leather with Granite Gray contrast diamond stitching

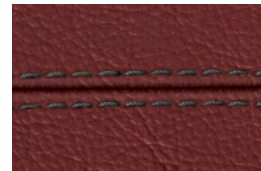

Arras Red Audi design selection

RS 7

RS 7 Sport Seat



Black Valcona leather with Rock Gray contrast honeycomb stitching

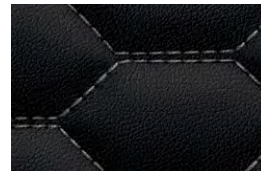

Lunar Silver Valcona leather with Rock Gray contrast honeycomb stitching

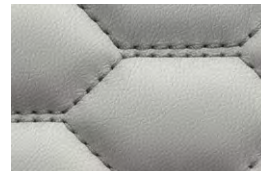

A7 S7 RS 7

Individual Contour Seat



Black Perforated Valcona leather



A7, S7, RS 7

Nougat Perforated Valcona leather



A7

Flint Gray Perforated Valcona leather

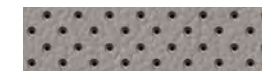

A7, S7

Atlas Beige Perforated Valcona leather

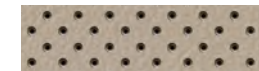

A7

Cedar Brown Perforated Valcona leather



A7 Cedar Brown Audi design selection

Technical Specifications

Engineering | Performance

	A7 3.0T	A7 TDI®	S7	RS 7
Engine type	Six-cylinder	Six-cylinder	Eight-cylinder	Eight-cylinder
Engine block/Cylinder head	Aluminum-alloy	Cast-iron/Aluminum-alloy	Aluminum-alloy	Aluminum-alloy
Displacement (cc)/Bore and stroke (mm)	2,995/84.5 x 89.0	2,967/ 83.0 x 91.4	3,993/84.5 x 89.0	3,993/84.5 x 89.0
Horsepower (@ rpm)	333 @ 5,300	240 @ 3,500	450 @ 5,800–6,400	560 @ 5,700–6,600
Torque (lb-ft @ rpm)	325 @ 2,900	428 @ 1,750	406 @ 1,400–5,700	516 @ 1,750–5,500
Compression ratio	10.3:1	16.8:1	10.1:1	10.1:1
Valvetrain	24-valve DOHC with variable valve timing	24-valve DOHC	32-valve DOHC with variable valve timing	32-valve DOHC with variable valve timing
Induction/Fuel injection	Supercharged/TFSI®	Turbocharged/TDI®	Turbocharged/TFSI®	Turbocharged/TFSI®
cylinder on demand™ engine efficiency technology ^{1,2}	—	—	■	■
Start-stop efficiency system ¹	■	■	■	—
Acceleration (0–60 mph)	5.2 seconds	5.6 seconds	4.5 seconds	3.7 seconds
Top track speed ³	130 mph	130 mph	155 mph	174 mph

Transmission | Drivetrain

Eight-speed Tiptronic® automatic transmission with quattro® all-wheel drive	■	■	—	■
Seven-speed S tronic® dual-clutch transmission with quattro® all-wheel drive	—	—	■	—
Sport differential	—	—	Available	■

Body | Suspension | Chassis

ultra® lightweight technology—aluminum exterior body panels and a steel chassis	■	■	■	■
Five-link front suspension	■	■	■	■
Trapezoidal-link rear suspension	■	■	■	■
Audi adaptive air suspension (with S or RS model-specific tuning)	—	—	■	■
DRC® sport suspension system (replaces Audi adaptive air suspension)	—	—	—	Available
Sport suspension calibration	Available	Available	■	■
Ventilated front disc/Ventilated rear disc brakes (in)	14.0/13.0	13.6/13.0	15.7/14.0	—
Ventilated wave-design front disc/Ventilated wave-design rear disc brakes (in)	—	—	—	15.4/14.0
Electromechanical power steering system	■	■	■	■
Dynamic steering	—	—	Available	■
Steering ratio	15.9:1	15.9:1	15.9:1	13.0:1
Turning diameter, curb-to-curb (ft)	39.0	39.0	39.0	39.0

Exterior measurements	A7 3.0T	A7 TDI®	S7	RS 7
Wheelbase (in)	114.7	114.7	114.7	114.8
Length (in)	195.6	195.6	195.6	197.3
Height (in)	55.9	55.9	55.9	55.8
Overall width with mirrors (in)	84.2	84.2	84.2	84.2
Track front/rear (in)	64.7/64.4	64.7/64.4	64.7/64.4	64.3/64.0
Curb weight (lb)	4,288	4,354	4,564	4,475
Drag coefficient (Cw)	.28	.29	.30	.30

Interior measurements	A7 3.0T	A7 TDI®	S7	RS 7
Head room with sunshade (in, front/rear)	36.9/36.6	36.9/36.6	36.9/36.6	36.9/36.6
Leg room (in, front/rear)	41.3/37.0	41.3/37.0	41.3/37.0	41.3/37.0
Shoulder room (in, front/rear)	57.2/55.9	57.2/55.9	57.2/55.9	57.2/55.9
Cargo volume (cu ft, rear seatbacks up)	24.5	24.5	24.5	24.5
Seating capacity	5	5	4	4

EPA mileage estimates Capacities Emissions	A7 3.0T	A7 TDI®	S7	RS 7
Tiptronic® automatic transmission (city/highway/combined)	20/30/24 ¹	25/38/30 ¹	—	NA ²
S tronic® dual-clutch transmission (city/highway/combined)	—	—	17/27/21 ¹	—
Engine oil (qt)	7.2	7.2	8.8	8.8
AdBlue® (gal)	—	5.0	—	—
Fuel (gal)	19.8	19.2	19.8	19.8
Required fuel	Premium	Ultra-low-sulfur diesel	Premium	Premium
Emissions rating	ULEV II	ULEV II	ULEV II	ULEV II

¹ EPA estimates. Your mileage will vary and depends on several factors, including your driving habits and vehicle condition. See www.fueleconomy.gov for details. ² EPA estimates not available at time of printing. See www.fueleconomy.gov for updated information. Your mileage will vary and depends on several factors, including your driving habits and vehicle condition. ³ Top track speed is electronically limited in the U.S. Always obey all speed and traffic laws.

Great lines make the performance more memorable.

With the available S line® Sport package, we give Audi Sport® style to an already stunning Audi vehicle. So with Audi A7 models, you can get the more aggressive lines — and double takes — that come with Audi Sport design. More striking lines define the exterior, while a lowered stance, provided by the sport suspension calibration, and Galvano Silver-finished 19" Audi Sport 7-twin-spoke design wheels add to its visual appeal. The S line is a premium collection of design cues and features that make the overall performance of your vehicle that much more memorable.



2016 Audi A7 3.0T Prestige shown in Glacier White metallic with S line® Sport package and available equipment.

There's always another story.

Our story doesn't end with this brochure. In fact, we have many more stories to tell at Audi library. Simply download Audi library from the Apple® App StoreSM or Google PlayTM store, and you can read everything, from other model and accessory brochures to special-edition pieces to the award-winning *Audi Magazine*. Dive into a massive trove of Audi specs, interactive content, videos, stories and technologies, just by downloading them on your tablet!

To download the Audi library app to your device, just follow these steps:

- > Go to the Apple® App StoreSM or Google PlayTM store
- > Search for "Audi library"
- > Download the app to your device¹

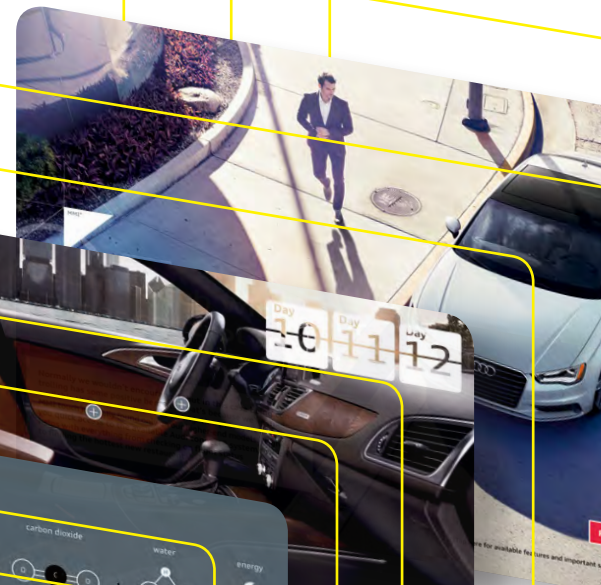
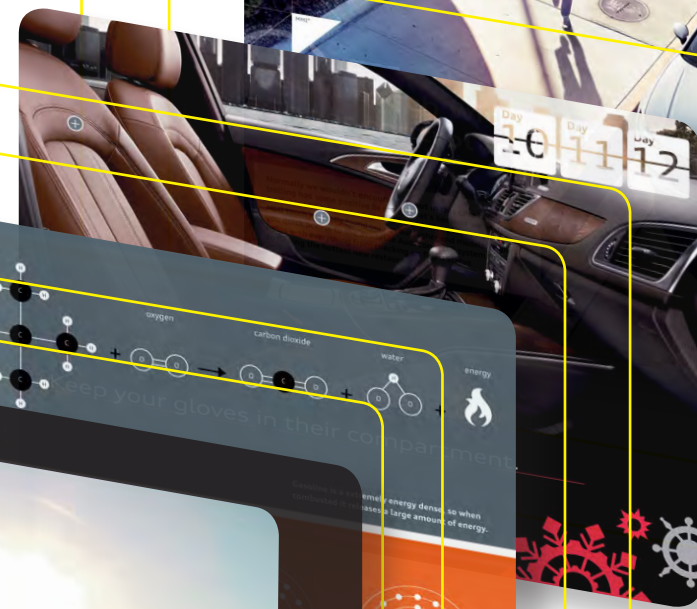

¹ Standard text and data usage rates apply. Always pay careful attention to the road, and do not drive while distracted.

Audi Genuine Accessories

Add distinction, versatility and the ultimate in self-expression with Audi Genuine Accessories. Whether you load the cargo carrier with climbing gear or add a set of stylish new wheels, we offer accessories to help enhance every facet of your lifestyle. When purchased from an authorized dealer, all pieces are backed by your vehicle's 4-year/50,000-mile limited warranty, or for 12 months/12,000 miles from the accessory purchase date, whichever is greater.¹ If you're looking to personalize or help protect the vehicle you love, we have a solution designed by Audi that works for you.

Audi Genuine Sport and Design Accessories

For a bolder appearance or a finishing touch, we have a solution that helps make every mile more enjoyable—and more yours.

- > Stylish wheel designs
- > License plate frames

Audi Genuine Electronics Accessories

Our audio options help enhance your listening pleasure, while other accessory options help promote convenience.

- > iPhone® adapter cable
- > Emergency tool

Audi TravelSpace Transport Accessories

Wherever you go, help make sure everything fits with a variety of intelligent and innovative solutions.

- > Base carrier bars
- > Bike and ski racks
- > Rooftop cargo carriers
- > In-vehicle cargo bags

Audi Guard Comfort and Protection Accessories

Help protect what you love. Use Audi Guard Comfort and Protection Accessories to help keep your Audi looking like new—inside and out.

- > Floor mats
- > Splash guards
- > Cargo mats



Visit parts.audiusa.com to view the full line of Audi Genuine Accessories.

¹ Audi Genuine Accessories purchased from an authorized Audi dealer are covered for the greater of: (1) the accessory limited warranty period (12 months or 12,000 miles, whichever occurs first) from the time of purchase; or (2) the remainder of the New Vehicle Limited Warranty period (48 months or 50,000 miles, whichever occurs first). See your authorized Audi dealer for details. ² All roof-rack system attachments require the base carrier bars. All attachments sold separately. Recreational equipment, sporting equipment and luggage not included. ³ Actual product may vary slightly from image shown. ⁴ Even with appropriate tires, you must always drive in a manner appropriate for the weather, visibility and road conditions, and you must maintain more distance from other vehicles since braking distances will be longer on ice- and snow-covered roads.

01 Aluminum bike rack

This locking holder fits 20- to 80-mm bike frames with both wheels on the bike and helps keep your bike upright as you secure it in place.²

02 Ski and snowboard racks

These racks help transport your equipment to the slopes easily and securely. The standard attachment (shown) holds two sets of skis or two snowboards. A deluxe attachment is also available.

03 All-weather car cover

Help protect your A7 from the elements with a lightweight, easy-to-use Stormshield® cover. Includes a storage bag.³

04 A7/S7 19" 5-V-spoke winter wheel and tire package

Adding style and performance, winter wheel and tire packages feature winter tires specifically engineered to help improve traction and handling in snow, ice—and even on dry roads—in temperatures below 45°F.⁴ See your authorized Audi dealer for details.

05 A7 20" 5-arm parabolic wheel and tire package

Add an impressive finishing touch with this eye-catching design. This package features Anthracite wheels with machine-polished spokes fitted with Audi Original Tires.

06 S7 premium textile floor mats

These skid-resistant, precision-fit mats are made of long-life fabric to help protect your vehicle's interior from the elements. Mats are black with silver piping and feature the S7 logo. They are available in a set of four.

07 All-weather floor mats

Deep-ribbed, channeled design helps protect your vehicle's floor from water, mud, sand and snow. Black mats are available in sets of two for front or rear. Front mats feature the A7 logo.

08 Load-protection film

This custom-fit transparent film helps protect the rear bumper from scratches while loading and unloading. The red outline depicts the coverage area.

09 All-weather cargo mat

Custom fit for your A7, the raised outside edge of the cargo mat helps contain spills and protects cargo-area carpeting from stains. The textured material helps control load shifting.



01



02



03



04



05



06



07

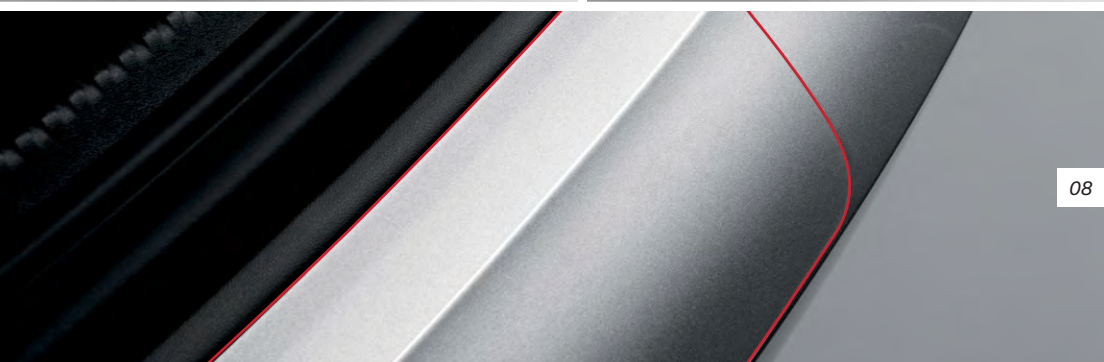

08



09



A7
S7
RS 7
> 2016

Audi of America
Audiusa.com
Facebook.com/Audi

© 2015
Audi of America, Inc.
Printed in the U.S.A.
AoA1616827

>
>

Note: A word about this brochure. Audi of America, Inc., believes the specifications in this brochure to be correct at the time of printing. However, specifications, standard equipment, options, fabrics, and colors are subject to change without notice. Some equipment may be unavailable when your vehicle is built. Please ask your dealer for advice concerning current availability of standard and optional equipment, and your dealer will verify that your vehicle will include the equipment you ordered. Vehicles in this brochure are shown with optional equipment. See your dealer for complete details on the Audi New Vehicle Limited Warranty, twelve-year limited warranty against corrosion perforation, and Audi 24/7 Roadside Assistance. (Roadside assistance coverage provided by Road America in the U.S. Certain conditions apply; see your dealer for details.) Tires supplied by various manufacturers. "Audi," all model names, "Audi connect," "Audi pre sense," "Audi Sport," "cylinder on demand," "DRC," "FSI," "MMI," "quattro," "Sideguard," "Singleframe" and the Singleframe grille design, "S line," "S tronic," "TFSI," "Truth in Engineering," "ultra," and the four rings logo are trademarks or registered trademarks of AUDI AG. "AdBlue" is a registered trademark of the Verband der Automobilindustrie. "Alcantara" is a registered trademark of Alcantara S.p.A. "Apple" is a registered trademark of Apple Inc. "App Store" is a service mark of Apple Inc. "Bang & Olufsen" is a registered trademark of Bang & Olufsen. The BLUETOOTH word mark and logos are owned by the Bluetooth SIG, Inc., and any use of such marks by AUDI AG is under license. "BOSE" and "AudioPilot" are registered trademarks of the BOSE Corporation. "Facebook" is a registered trademark of Facebook, Inc. "Google," "Google Earth," "Google Play," "Google Voice" and "Google Voice Search" are trademarks of Google Inc. "HD Radio" and the HD Radio logo are proprietary trademarks of iBiquity Digital Corporation. "Homelink" is a registered trademark of Johnson Controls Technology Company. "INRIX" is a registered trademark of INRIX, Inc. "NVIDIA" and "Tegra" are registered trademarks of NVIDIA Corporation. "SiriusXM" and all related marks and logos are trademarks of Sirius XM Radio Inc. and its subsidiaries. "Stormshield" is a registered trademark of Guilford Mills, Inc. "TDI" is a registered trademark of Volkswagen AG. "Tiptronic" is a registered trademark of Dr. Ing h.c. F. Porsche AG. "Twitter" is a registered trademark of Twitter, Inc. "Wi-Fi" is a registered trademark of the Wi-Fi Alliance. All other trademarks are the property of their respective owners. Some European models shown.