



FOUR X THE ATTITUDE.

If you're looking to generate some serious attention, the BMW X4's aggressive looks and coupe-like profile will give onlookers something to talk about. Matched only by its luxurious interior, the X4's muscular lines look even better when you hear its TwinPower Turbo engine roar.

BMW X4

EXTERIOR COLORS

UPHOLSTERY

INTERIOR TRIMS

WHEELS / TIRES

PACKAGES

TECHNICAL DATA



BREATHING ROOM.

Functionality is a hallmark of the BMW X4. It has a cargo compartment that can be expanded from 17.7 cubic feet to a maximum of 49.4 cubic feet. The Storage Package with luggage nets and lashing rails keeps your belongings secure and neat.



THE POWER OF SOUND.

The Harman Kardon® Surround Sound System utilizes X4-specific equalizing and a powerful 600 watt amplifier to pump out sound from 16 cabin speakers.

BMW X4 EXTERIOR COLORS

NON-METALLIC

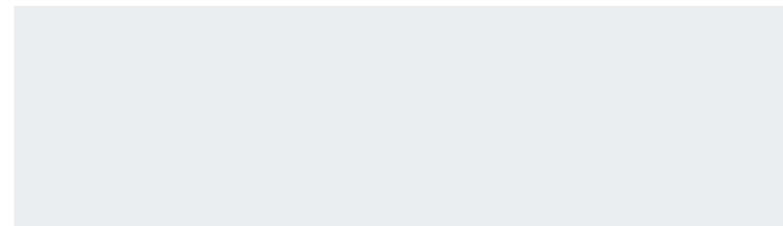

300 Alpine White (Non-metallic)

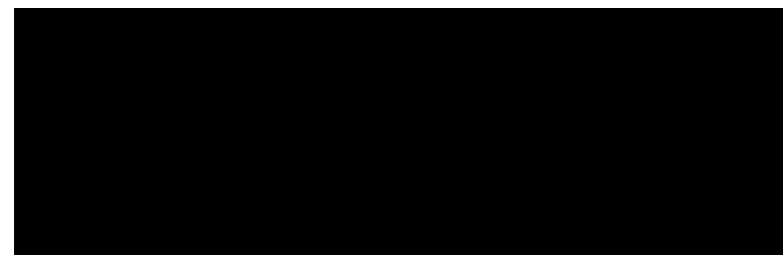

668 Jet Black (Non-metallic)

METALLIC

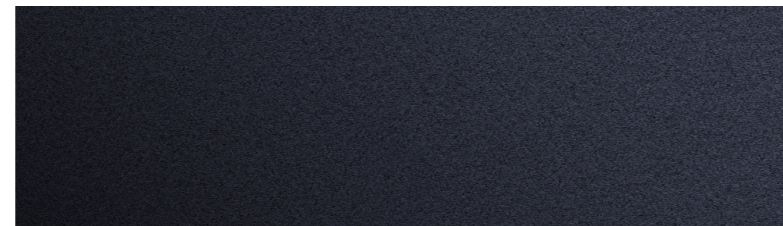

416 Carbon Black Metallic

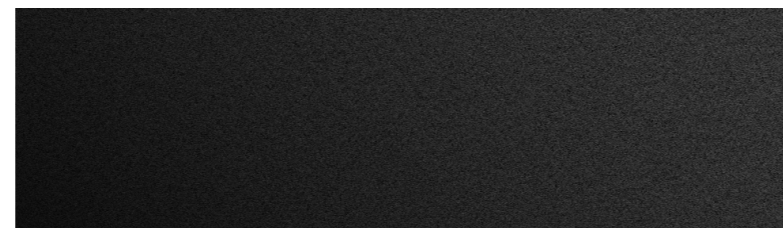

475 Black Sapphire Metallic

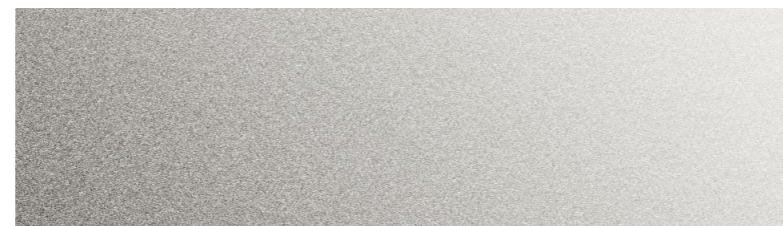

A14 Mineral Silver Metallic

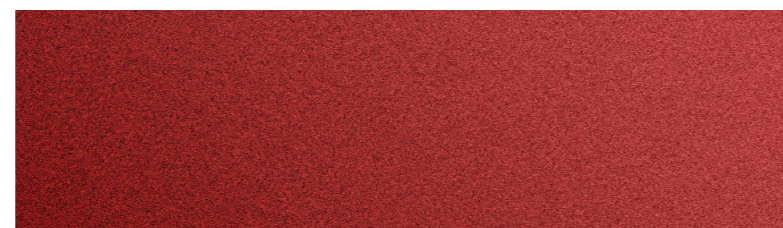

A75 Melbourne Red Metallic



A76 Deep Sea Blue Metallic

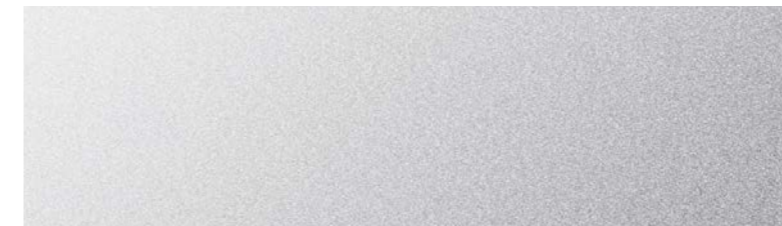

A83 Glacier Silver Metallic



A90 Dark Graphite Metallic

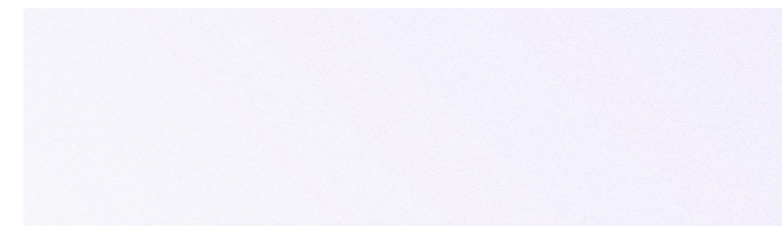

A96 Mineral White Metallic

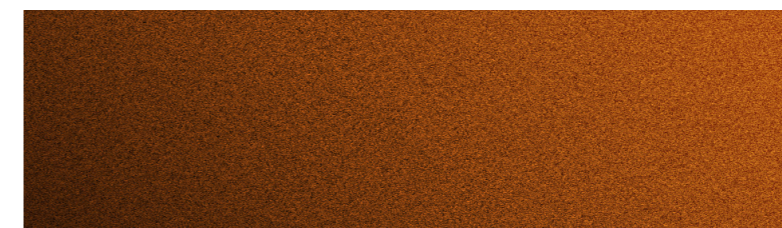

C29 Chestnut Bronze Metallic

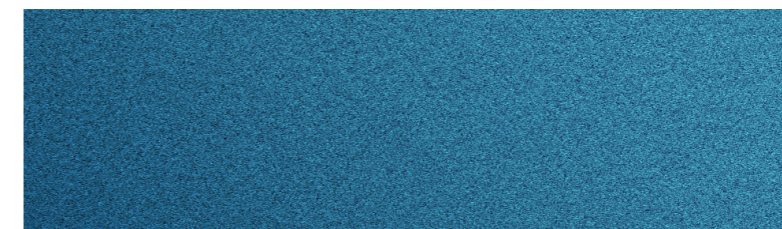

C16 Long Beach Blue Metallic

BMW X4 UPHOLSTERY

SENSATEC



KCBI Beige / Black SensaTec

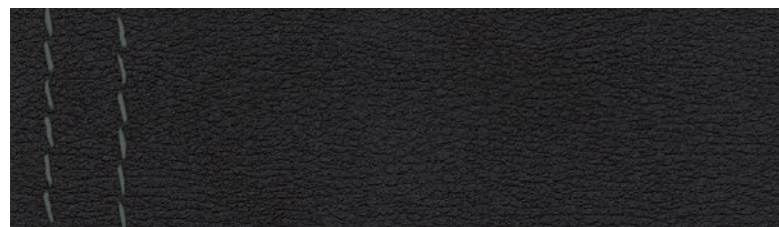

KCSW Black SensaTec

NEVADA LEATHER

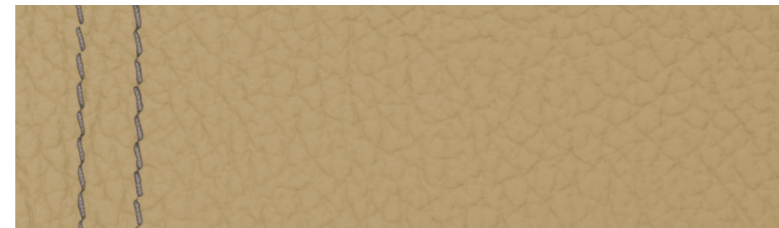

LUBI Sand Beige / Black Nevada Leather

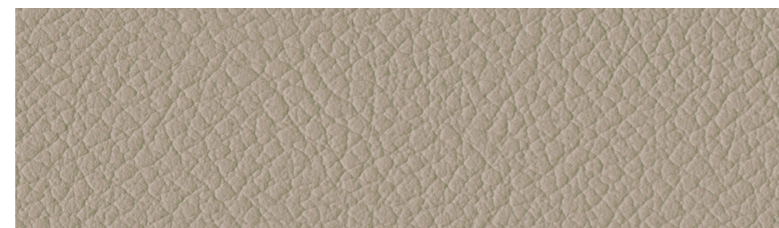

LUCX Oyster Nevada Leather

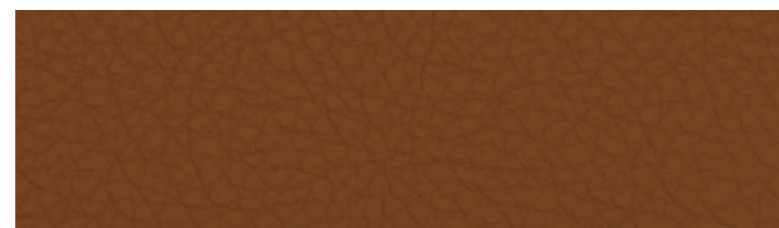

LUD3 Saddle Brown Nevada Leather

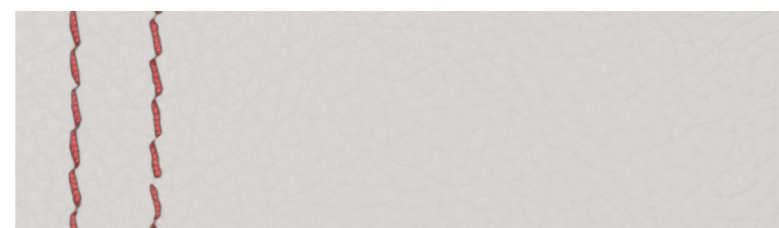

LUNE Ivory White Nevada Leather / exclusive Red contrast stitching

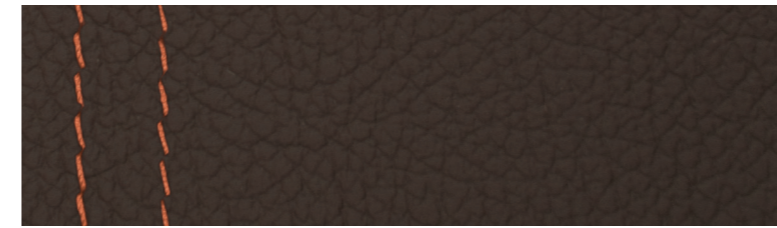

LUNF Mocha Nevada Leather / exclusive Orange contrast stitching

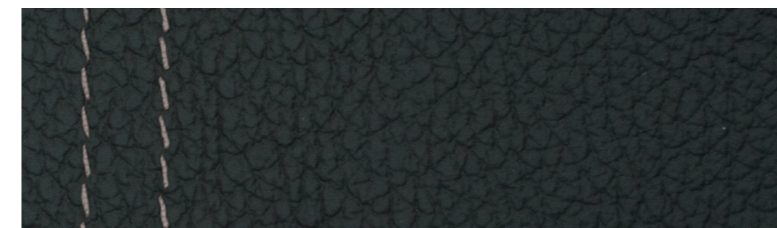

LUSQ Black Nevada Leather / exclusive Gray contrast stitching

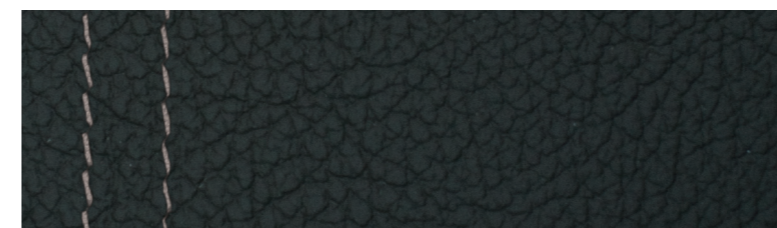

LUSW Black Nevada Leather / exclusive Gray contrast stitching

Leather: Leather on all seating surfaces; other components may be Leather or SensaTec.

BMW X4 INTERIOR TRIMS



4AD Brushed Aluminum trim



4FV High-gloss Finesline Light Wood trim /
Chrome highlight

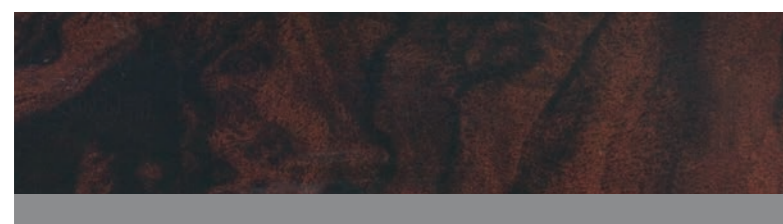

4FW Burl Walnut Wood trim /
Pearl Gloss Chrome highlight

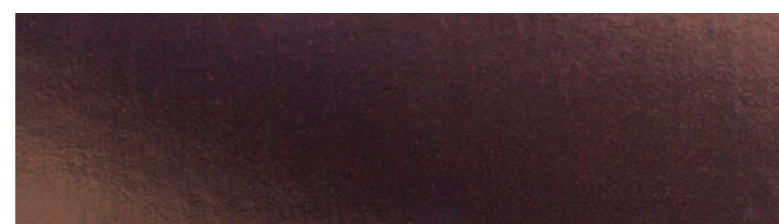

4L3 High-gloss Dark Copper trim

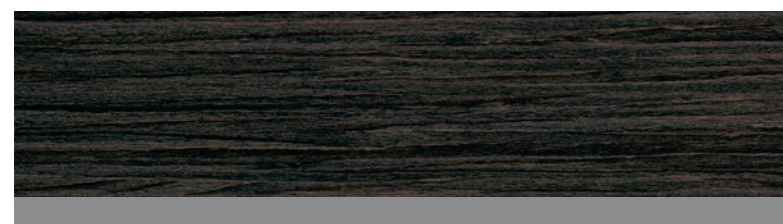

4FU Finesline Anthracite Wood trim /
Pearl Gloss Chrome highlight

BMW X4 WHEELS / TIRES



Double Spoke light alloy wheels (Style 680M)
20 x 8.5 front, 20 x 10.0 rear and; 245/40 front and 275/35 rear non run-flat Michelin® Pilot Super Sport tires^{2,3}



Star Spoke light alloy wheels (Style 606)
19 x 8.5 front and rear; and 245/45 front and rear run-flat all-season tires^{2,3}



Y Spoke light alloy wheels (Style 608)
19 x 8.5 front and rear; and 245/45 front and rear run-flat all-season tires^{2,3}



Double Spoke light alloy wheels (Style 605)
18 x 8.0 front and rear; and 245/50 front and rear run-flat all-season tires^{2,3}



Double Spoke light alloy wheels (Style 622M)
19 x 8.5 front, 19 x 9.5 rear; and 245/45 front, 275/40 rear run-flat¹ performance tires^{2,3}
19 x 8.5; and 245/45 run-flat¹ all-season tires²



Double Spoke High-Gloss light alloy wheels (Style 310M)
20 x 8.5 front, 20 x 10.0 rear and; 245/40 front and 275/35 rear run-flat performance tires^{2,3}

¹ Run-flat tires do not come equipped with a spare wheel and tire.

² Driving over rough or damaged road surfaces, as well as debris, curbs and other obstacles, can cause serious damage to wheels, tires and suspension parts. This is more likely to occur with low-profile tires, which provide less cushioning between the wheel and the road. Be careful to avoid road hazards and reduce your speed, especially if your vehicle is equipped with low-profile tires.

³ Performance tires include Mobility Kit; not recommended for driving in ice and snow conditions.

BMW X4 PACKAGES

DRIVER ASSISTANCE PLUS

Active Blind Spot Detection
Active Driving Assistant¹
ACC with Stop & Go^{1,2} + Active Driving Assistant¹
(optional)
Surround View
Speed Limit Info

PREMIUM PACKAGE

Comfort Access keyless entry
Lumbar support
SiriusXM[®] Satellite Radio with 1-year subscription
Nevada Leather Upholstery

DRIVER ASSISTANCE PACKAGE

Rear-view Camera
Park Distance Control

TECHNOLOGY PACKAGE

BMW Navigation system
Head-up Display
BMW Online and BMW Apps
Advanced Real-Time Traffic Information
BMW Remote Services
Instrument cluster with extended contents

LIGHTING PACKAGE

Adaptive Full LED Lights
Automatic high beams

COLD WEATHER PACKAGE

Heated steering wheel
Heated front seats
Heated rear seats
Retractable headlight washers

¹ Active Driving Assistant is not a substitute for the driver's own responsibility in maintaining safe control of the vehicle.

² After evaluating the road, traffic and visibility conditions, the driver must decide whether and how Active Cruise Control is to be used.

Not all features are available on all models. Get the latest information on standard and optional features, packages and technical specifications. Visit bmwusa.com and select the BMW model of your choice.

BMW X4 TECHNICAL DATA

	X4 xDrive28i	X4 M40i
ENGINE	2.0-liter TwinPower Turbo inline 4-cylinder	3.0-liter M Performance TwinPower Turbo inline 6-cylinder
OUTPUT @ RPM	240 hp @ 5000-6500 / 260 lb-ft @ 1450-4800	355 hp @ 5800-6000 / 343 lb-ft @ 1350-5250
0-60 MPH (sec) ¹	6.0	4.7
CITY / HIGHWAY / COMBINED MPG	20/27/23	19/26/21

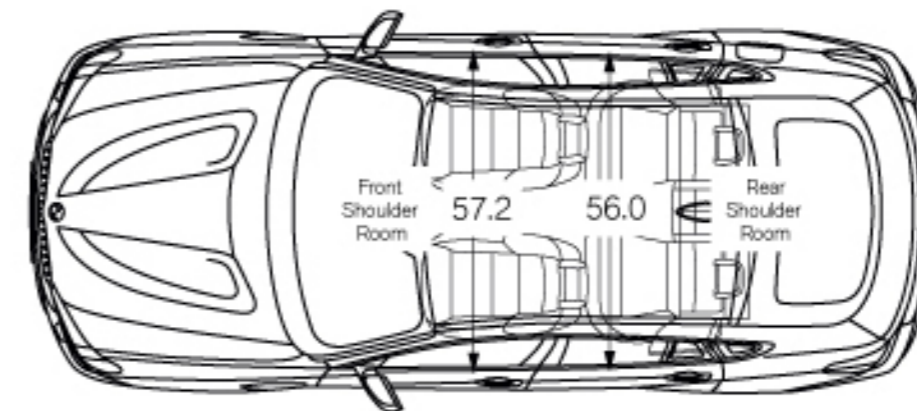
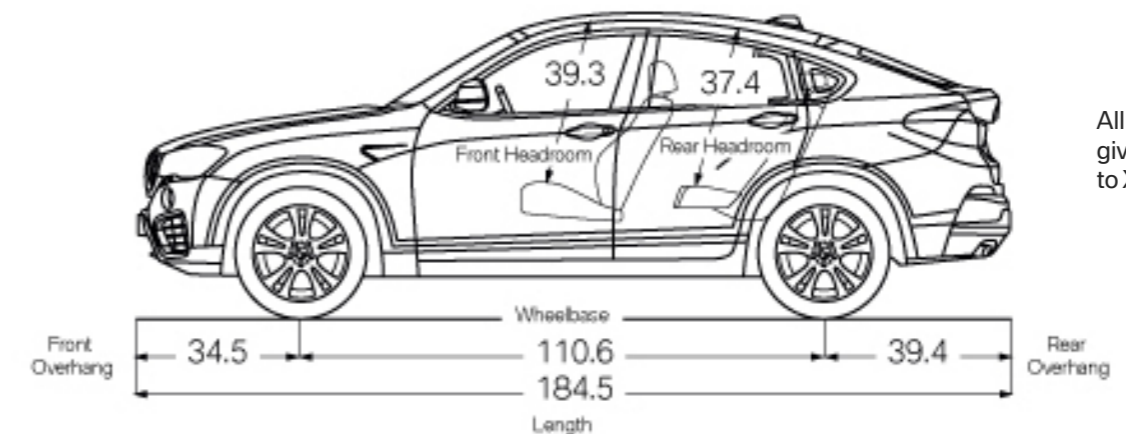
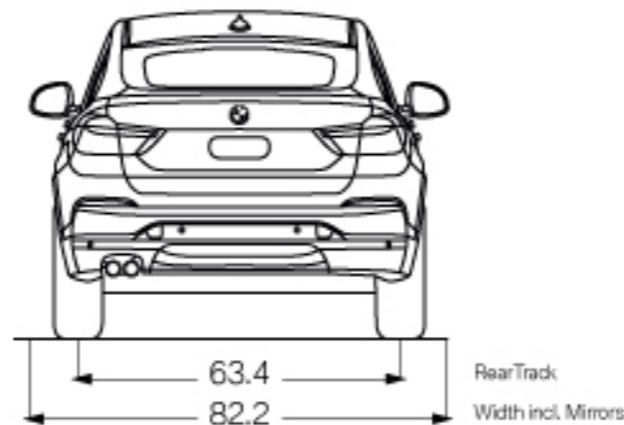
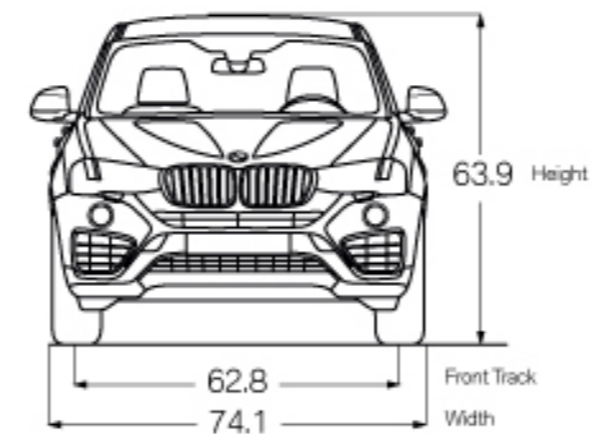

All dimensions in technical drawings are given in inches. Dimensions shown apply to X4 xDrive28i.

Figures subject to change. Not all packages available in all models. Please visit your BMW Retailer or bmwusa.com for the most up-to-date information.

¹BMW AG preliminary test results. Actual acceleration results may vary, depending on specification of vehicle; road and environmental conditions; testing procedures and driving style. These results should be used for comparison only and verification should not be attempted on public roads. BMW urges you to obey all posted speed laws and always wear safety belts.

Not all features are available on all models. Get the latest information on standard and optional features, packages and technical specifications. Visit bmwusa.com and select the BMW model of your choice.

THREE'S A CHARM.

Versatility, performance and style. The BMW X3 delivers all you'd want in a Sports Activity Vehicle with the driving dynamics you've come to expect from BMW. Striking the perfect equilibrium of agility, utility and power, the X3 is part workhorse, part thoroughbred and all BMW.



BMW X3

EXTERIOR COLORS

UPHOLSTERY

INTERIOR TRIMS

WHEELS / TIRES

PACKAGES

TECHNICAL DATA



LAP OF LUXURY.

Let the X3 take you home in style and comfort. Eight-way power adjustable front sport seats with manual thigh bolsters and power lumbar support ensures you'll find that just right driving position, no matter how long the trip.



CABIN WITH A SKY VIEW.

The Panoramic Moonroof is an additional BMW luxury available with the Premium Package. It highlights the roomy interior of the X3 and gives an unparalleled view of clear blue skies and star-filled nights.

BMW X3 EXTERIOR COLORS

NON-METALLIC

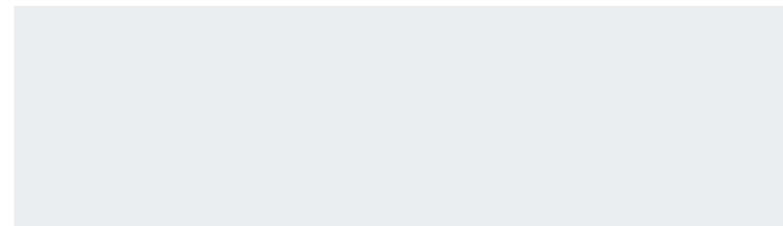

300 Alpine White (Non-metallic)

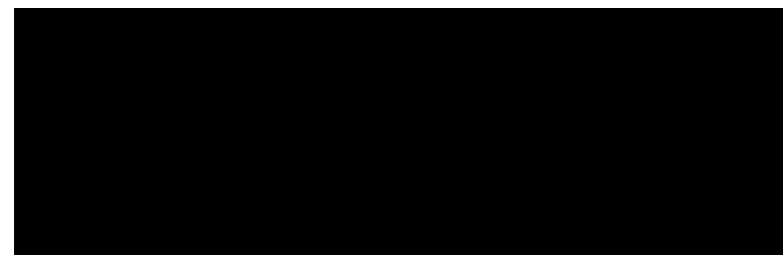

668 Jet Black (Non-metallic)

METALLIC

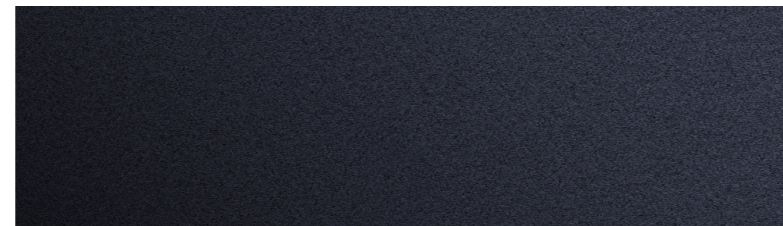

416 Carbon Black Metallic

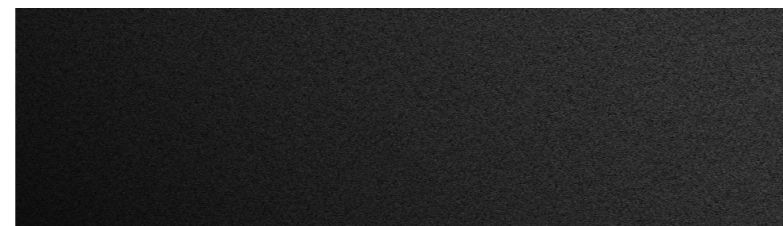

475 Black Sapphire Metallic

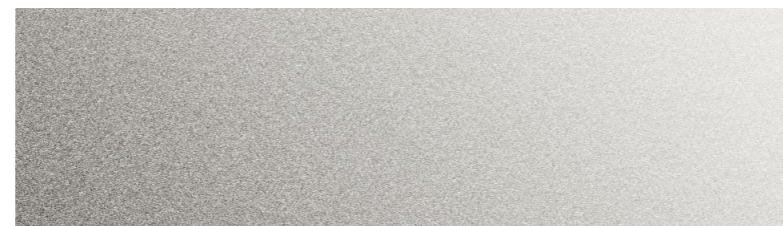

A14 Mineral Silver Metallic



A52 Space Gray Metallic



A75 Melbourne Red Metallic



A76 Deep Sea Blue Metallic



A83 Glacier Silver Metallic

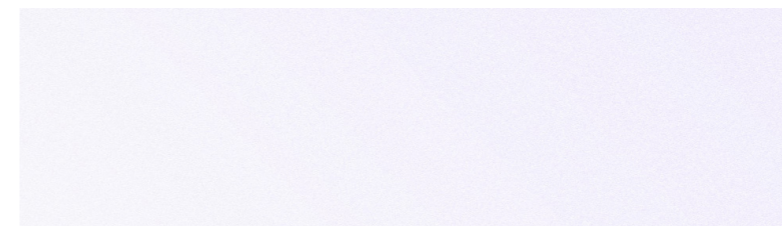

A96 Mineral White Metallic

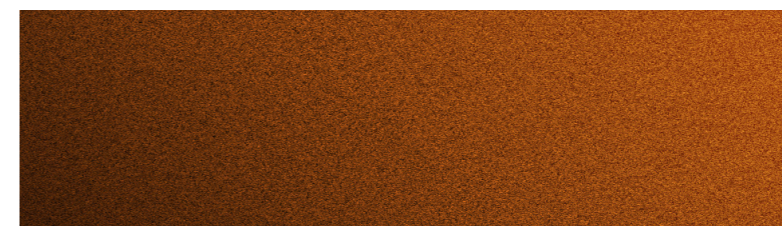

C29 Chestnut Bronze Metallic

BMW X3 UPHOLSTERY

SENSATEC



KCBI Beige / Black SensaTec



KCSW Black SensaTec

NEVADA LEATHER

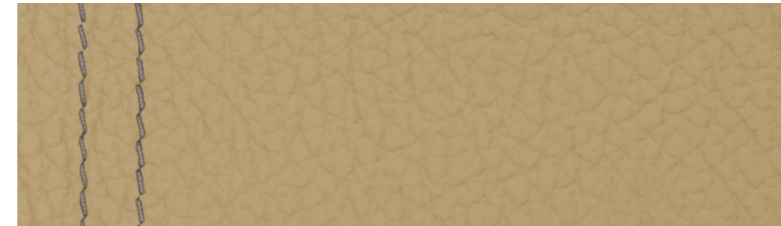

LUBI Sand Beige / Black Nevada Leather



LUCX Oyster Nevada Leather

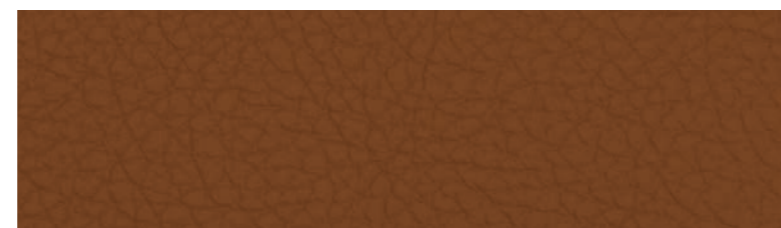

LUD3 Saddle Brown Nevada Leather

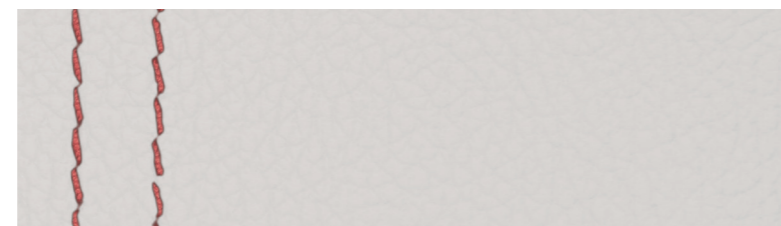

LUNE Ivory White Nevada Leather / Exclusive Orange Contrast Stitching

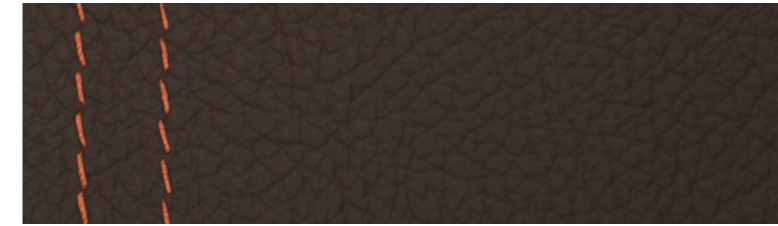

LUNF Mocha Nevada Leather / Exclusive Orange Contrast Stitching

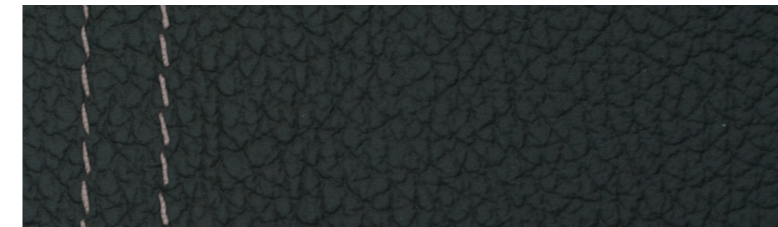

LUSQ Black Nevada Leather / Exclusive Gray Contrast Stitching

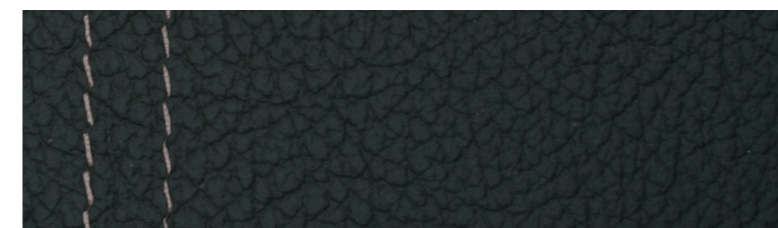

LUSW Black Nevada Leather / Exclusive Gray Contrast Stitching

Leather: Leather on all seating surfaces; other components may be Leather or SensaTec.

BMW X3 INTERIOR TRIMS

INTERIOR TRIMS



4AD Brushed Aluminum trim



4FV Fineline Light High Gloss Wood trim /
Chrome highlight

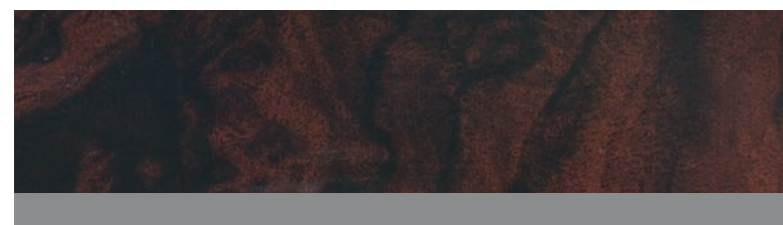

4FW Burl Walnut Wood trim /
Pearl Gloss Chrome highlight

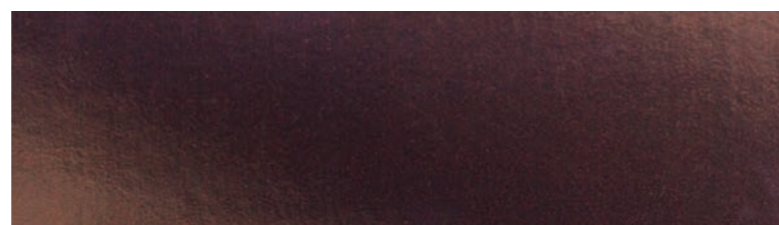

4L3 Dark Copper High Gloss trim

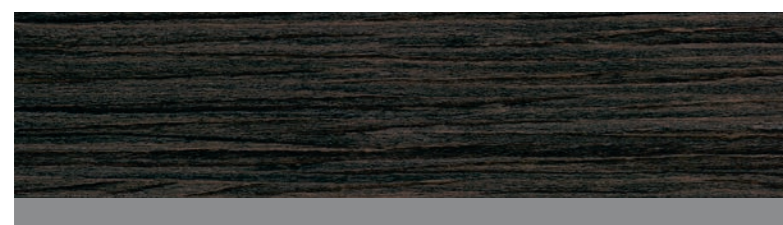

4FU Fineline Anthracite Wood trim /
Pearl Gloss Chrome highlight

BMW X3 WHEELS / TIRES



Star Spoke light alloy wheels (Style 606)
19 x 8.5 front and rear; and 245/45 front and rear run-flat all-season tires^{2,3}



Y Spoke light alloy wheels (Style 608)
19 x 8.5 front and rear; and 245/45 front and rear run-flat all-season tires^{2,3}



V Spoke light alloy wheels (Style 307)
18 x 8.0 front and rear; and 245/50 front and rear run-flat all-season tires^{2,3}



Double Spoke light alloy wheels (Style 605)
18 x 8.0 front and rear; and 245/50 front and rear run-flat all-season tires^{2,3}



Double Spoke light alloy wheels (Style 622M)
19 x 8.5 front, 19 x 9.5 rear; and 245/45 front, 275/40 rear run-flat¹ performance tires^{2,3}

19 x 8.5; and 245/45 run-flat¹ all-season tires²



Double Spoke High-Gloss light alloy wheels (Style 310M)
20 x 8.5 front, 20 x 10.0 rear and; 245/40 front and 275/35 rear run-flat performance tires^{2,3}

¹ Run-flat tires do not come equipped with a spare wheel and tire.

² Driving over rough or damaged road surfaces, as well as debris, curbs and other obstacles, can cause serious damage to wheels, tires and suspension parts. This is more likely to occur with low-profile tires, which provide less cushioning between the wheel and the road. Be careful to avoid road hazards and reduce your speed, especially if your vehicle is equipped with low-profile tires.

³ Performance tires include Mobility Kit; not recommended for driving in ice and snow conditions.

BMW X3 PACKAGES

DRIVER ASSISTANCE PLUS

Active Blind Spot Detection
Active Driving Assistant¹
ACC with Stop & Go^{1,2} + Active Driving Assistant¹
(optional)
Surround View
Speed Limit Info

PREMIUM PACKAGE

Comfort Access keyless entry
Lumbar support
Panoramic moonroof
SiriusXM[®] Satellite Radio with 1-year subscription
Nevada Leather Upholstery

DRIVER ASSISTANCE PACKAGE

Rear view camera
Park Distance Control

TECHNOLOGY PACKAGE

BMW Navigation system
Head-up Display
BMW Online and BMW Apps
Advanced Real-Time Traffic Information
BMW Remote Services
Instrument cluster with extended contents

COLD WEATHER PACKAGE

Heated Steering Wheel
Heated front seats
Heated rear seats
Retractable headlight washers

DYNAMIC HANDLING PACKAGE

Dynamic Damper Control
Performance Control
Variable sport steering

LIGHTING PACKAGE

Xenon headlights
Adaptive LED Lights
Automatic high beams
Adaptive light control

¹ Active Driving Assistant is not a substitute for the driver's own responsibility in maintaining safe control of the vehicle.

² After evaluating the road, traffic and visibility conditions, the driver must decide whether and how Active Cruise Control is to be used.

Not all features are available on all models. Get the latest information on standard and optional features, packages and technical specifications. Visit bmwusa.com and select the BMW model of your choice.

BMW X3 TECHNICAL DATA

	X3 sDrive28i	X3 xDrive28i	X3 xDrive35i	X3 xDrive28d
ENGINE	2.0-liter TwinPower Turbo inline 4-cylinder 240 hp @ 5000-6500 / 260 @ 1450-4800		3.0-liter TwinPower Turbo inline 6-cylinder 300 hp @ 5800 / 300 @ 1300-5000	2.0-liter TwinPower Turbo Diesel inline 4-cylinder 180 @ 4000 / 280 @ 1750-2750
OUTPUT @ RPM				
0-60 MPH (sec) ¹	6.2		5.3	7.8
CITY / HIGHWAY / COMBINED MPG	21/28/24		19/26/21	TBD

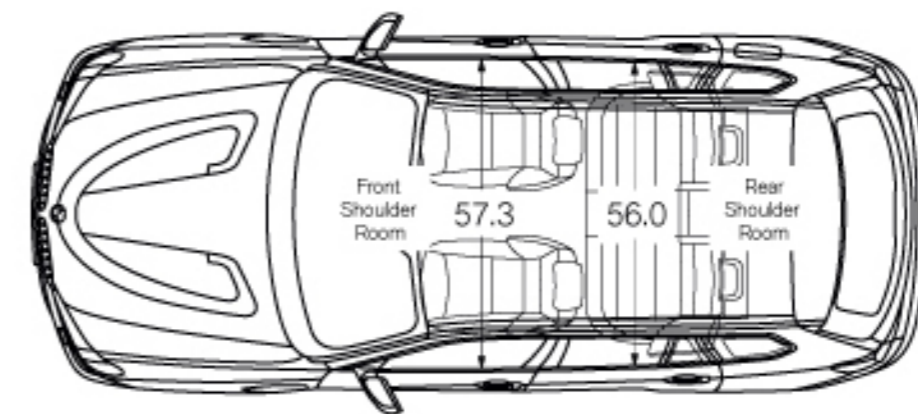
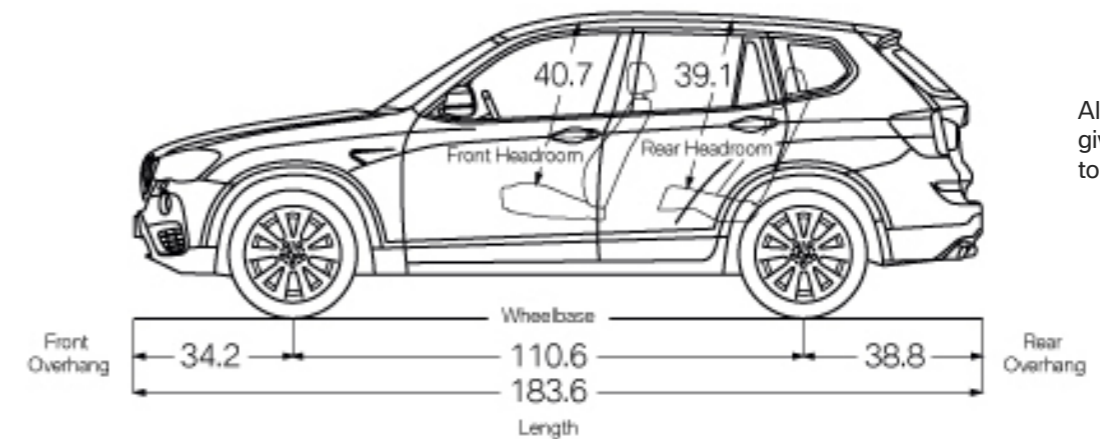
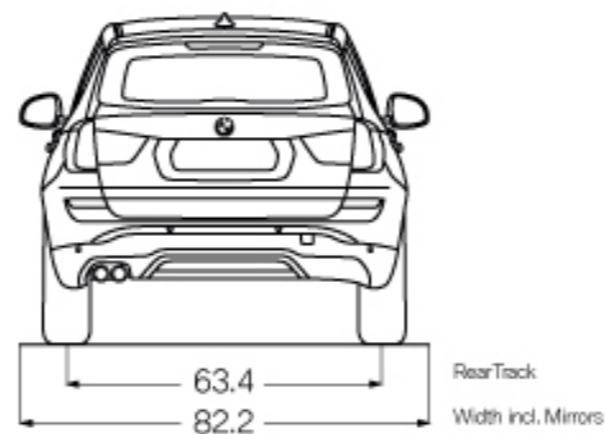
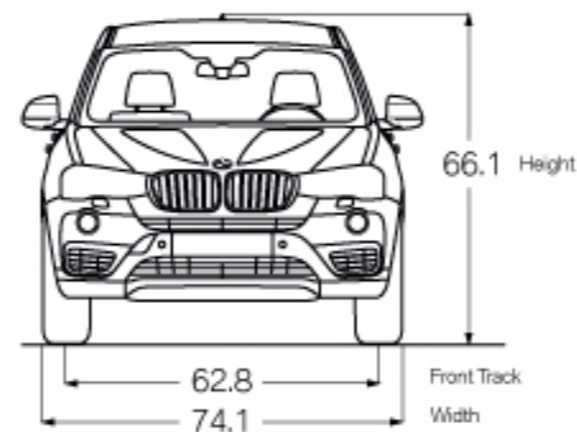

All dimensions in technical drawings are given in inches. Dimensions shown apply to X3 xDrive28i.

Figures subject to change. Not all packages available in all models. Please visit your BMW Retailer or bmwusa.com for the most up-to-date information.

¹BMW AG preliminary test results. Actual acceleration results may vary, depending on specification of vehicle; road and environmental conditions; testing procedures and driving style. These results should be used for comparison only and verification should not be attempted on public roads. BMW urges you to obey all posted speed laws and always wear safety belts.

Not all features are available on all models. Get the latest information on standard and optional features, packages and technical specifications. Visit bmwusa.com and select the BMW model of your choice.