

# Studebaker

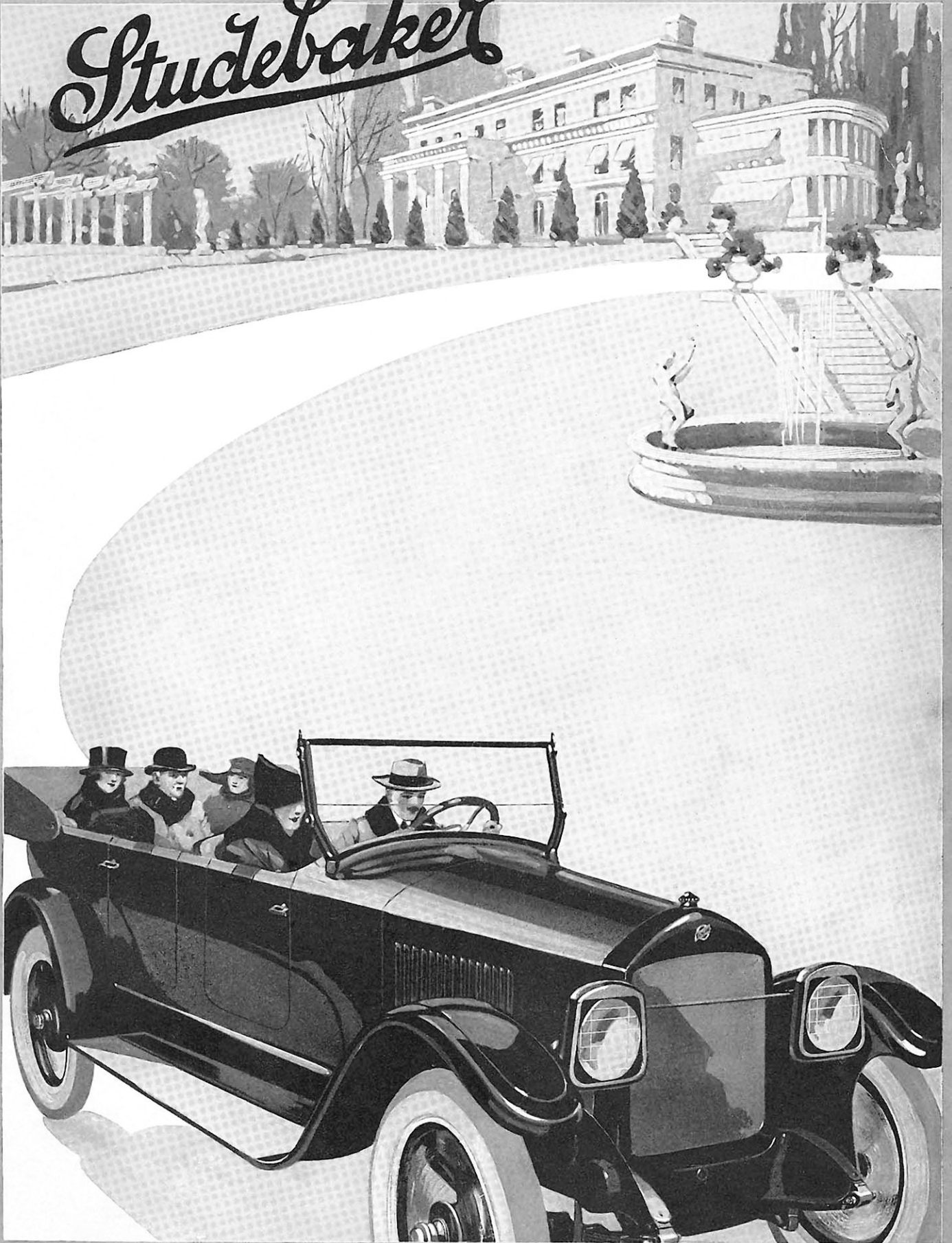

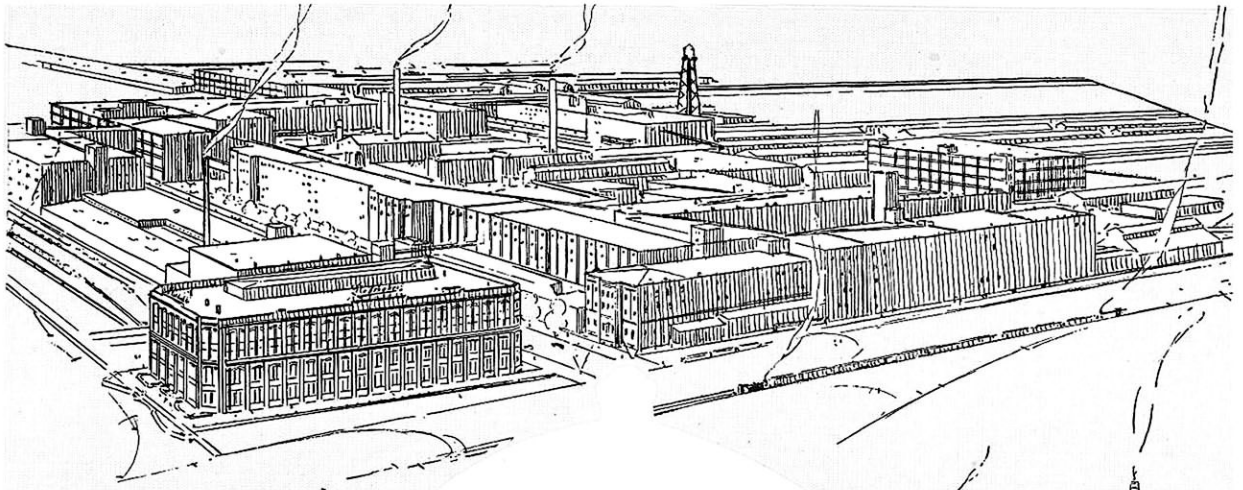

### ANNOUNCEMENT

The new Studebaker cars in three models embody our long experience together with the latest and greatest achievements of some of the ablest and most experienced engineers and production experts in the automobile industry. These cars are new throughout, with improved motors, intermediate transmission, new axles, bodies, tops, windshields, radiators, hoods, fenders, etc. They are beautiful in design, thoroughly modern and mechanically right.

Before finally approving these cars for production, experimental models of each car were driven thousands of miles under the severest conditions, through the mountains and country roads of the United States and Canada. And finally, to make assurance doubly sure they were driven for days and weeks over the Chicago Speedway. Never were we better satisfied with the performance of any cars in power, speed, endurance and riding comfort. These cars are the masterpieces of the Studebaker organization.

THE STUDEBAKER CORPORATION  
of AMERICA

Jan. 3, 1918

*W. L. Duesenberg*  
President

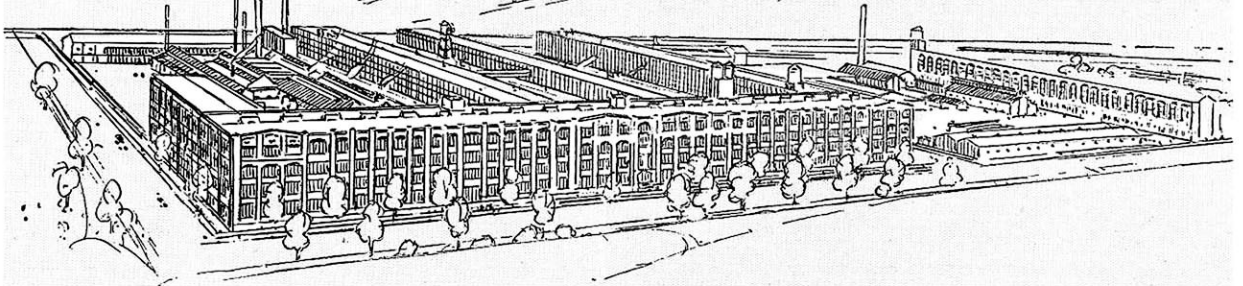
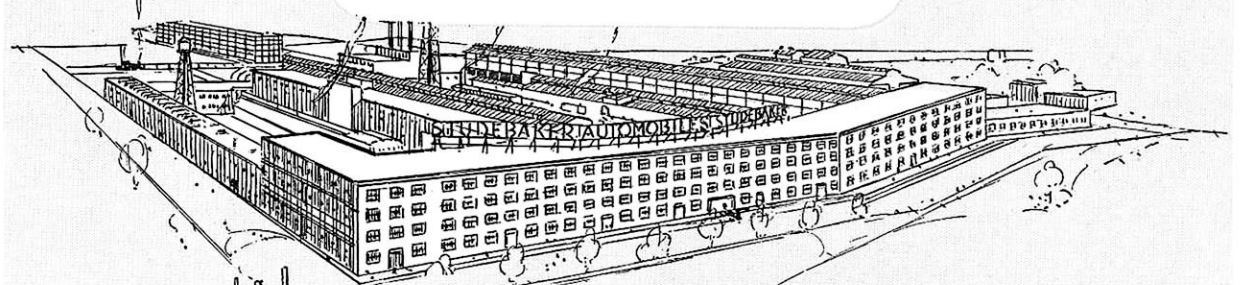
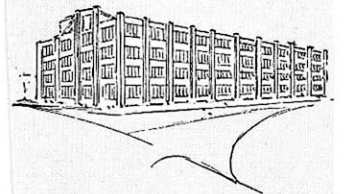
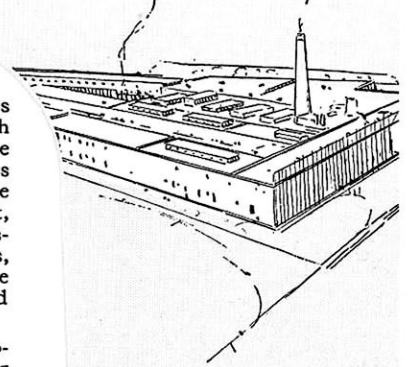
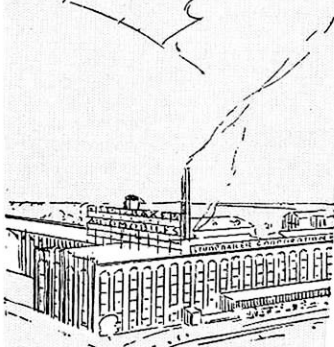
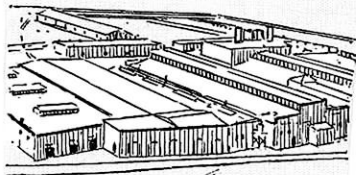

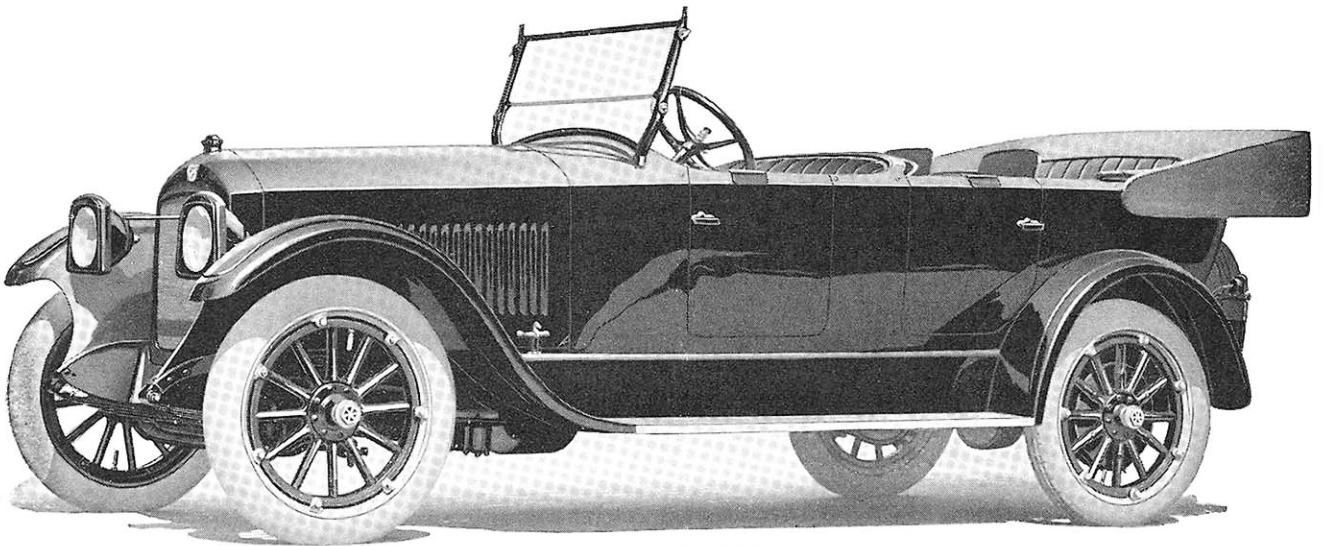

### THE BIG SIX

*This view shows the unusually distinctive beauty of this model — modish in the extreme. It sets a distinctively new style in beautiful body design.*

## *The Three New Studebaker Cars*

**I**N conception and appearance the New Series 19 Studebaker Cars express beauty, grace and refinement of design.

Every detailed unit of their construction reflects the painstaking skill of experts whose experience is available only to great organizations. It was determined, long ago, to summarize in this New Series the very best that men knew. And so one mechanical detail after another was weighed and considered; tested and accepted or rejected upon a purely quality basis. For the cost-element had no part in the design. The price was never even figured until after the preliminary models had been completed, tested, accepted.

That is why, entirely apart from the beautiful lines which compel the attention of anyone who appreciates grace and harmony, these cars are so far out of the ordinary. That is why we can take you hand-in-hand, so to speak, and show you every detail of construction, slighting nothing, proud in the confidence that the more of a mechanical expert you are, the more you will appreciate what you see. That is why these cars are exactly what you would yourself choose in detail and assembly, were you an

expert engineer and building the finest modern motor car from a standpoint of ripe experience.

And back of the engineering masterpieces which these new cars unquestionably are—guaranteeing their work and integrity to you—is the Studebaker organization. This—one of the world's greatest automobile producers, with a fifteen million dollar plant covering 168 acres, complete not only to the last modern device, but with chemical and mechanical laboratories where every piece and part is scientifically tested, and where quality is always first—this is the factory behind your car.

The New Series consists of three models, similar in general design, each of ideal size for its purpose—a 5-Passenger **LIGHT FOUR**; a 5-Passenger **LIGHT SIX** and a 7-Passenger **BIG SIX**.

The simplified, clean-cut chassis; the well-braced frame that directly supports the body sills at all points—clearly show the strength, solidity and simplicity of the whole chassis assembly—and this applies to the chassis of each model with equal force.

The full Hotchkiss drive, with extra-long semi-elliptic springs accurately

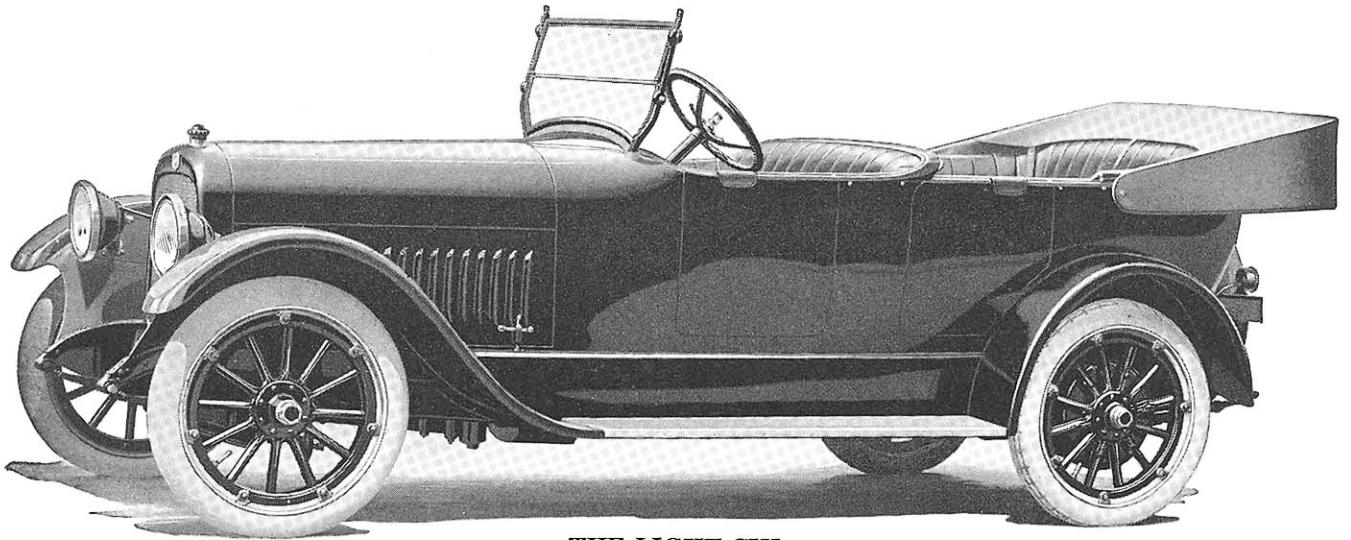

**THE LIGHT SIX**

*The lightness and speed of this car are indicated in the long, low lines. Note the blending of curves, the distinctively modeled front seat and the plain harmonious crown fenders. Conservative elegance, quality and good taste are the characteristics of this model.*

The five-passenger LIGHT SIX design and construction is similar to the BIG SIX, but the motor is a little smaller; the whole car is lighter. Its exterior appearance suggests the car it is; a beautifully-designed, light-weight car; a car with agility, speed, quick pickup, ideal power; a car that any member of the family can drive all day long without fatigue. The comfortable position of the seats; the deep, soft cushions; the ample leg-room; the simple noiseless gearshift; the great leverage developed by a touch of the brake and clutch-pedals; the certainty of the starting mechanism; the responsive flexibility of the motor and the remarkable ease with which the car steers and stays in the road—all these appeal instantly to the lover of a fine motor car—you will find them all in the Studebaker LIGHT SIX. The riding qualities of this model are very fine. It will travel 55 to 60 miles an hour, mile after mile, without uncomfortable vibration or apparent effort.

bushed and mounted to prevent rattling; the double flexible coupling; the spiral-bevel gears; and the carefully worked-out balance, produce smooth, easy riding qualities that you find usually only in much heavier and more expensive cars.

The “hot-spot” manifold, scientifically shaped, with its uniform distribution of gases; the increased valve-lift; the moderate car-weight; and the perfected, balanced motor, greatly reducing vibration,—all result in greater power and remarkable fuel-economy, even with poor grades of fuel.

The intermediate transmission; the location of the exhaust line and of the battery; the easily-removable push-rods; and the easy brake, valve, and fan adjustments are some of the details which mean accessibility and convenience to the owner-driver.

The improved steering design; the greater leverage on pedals; the responsiveness and flexibility of the motor; the

*Roominess, comfort, convenience—far more than you find in the front compartment of the average five-passenger car.*

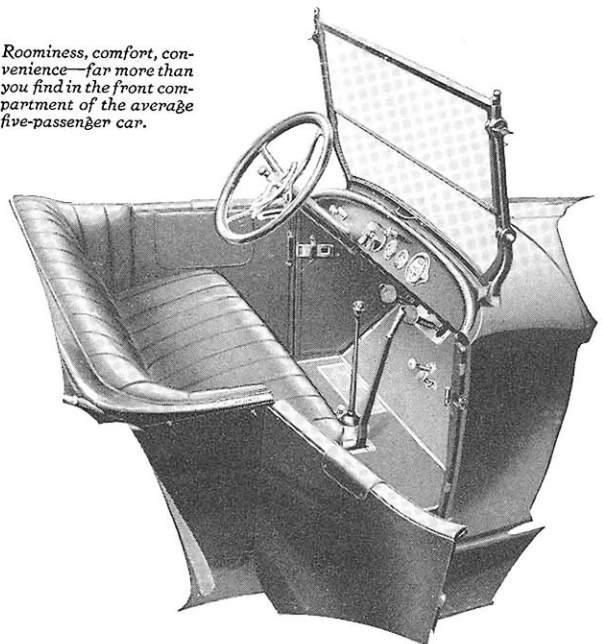

improved brakes; and the perfection of simple, quiet gear-shifting mean a new ease in driving.

The improved semi-floating rear axle, now standard on the best cars; the short, staunch propeller shaft, ending in Spicer joints; the new tubular radiator; and the new motor suspension are among the desirable modern features.

The duplex oiling system; the big factors of safety; the unlimited use of forgings and steel stampings; the high grade workmanship; the employment of chrome-nickel and vanadium steels; and the use of Timken bearings throughout, tell their own story of quality.

In these three chasses is a comprehensive summary of all that is new and best in motor car design.

We have, first, a carefully-developed chassis of remarkable strength, simplicity and of moderate weight—neither too light nor too heavy. We have a motor of ample power and great flexibility; a motor which utilizes every particle of fuel, operates satisfactorily on poor grades

of fuel, and delivers its power, without waste, to the rear wheels.

Then, we have an accessible motor. Every part has been so placed as to be easily reached for inspection or adjustment. We have a motor that is perfectly lubricated with clean, cool oil, through a duplex system that is entirely automatic and positive at all times. We have a motor which because of its rigidity, long crank shaft bearings, remarkable running balance, and complete utilization of fuel, delivers a marvelous smoothness of power at any speed.

From the motor to the rear wheels the transmission of power is flexible and not disturbed by rough and uneven roads. The impulses of the motor are utilized in a smooth flow of energy.

The application of power is made with minimum friction. Timken roller bearings are used in the chassis throughout.

The flexible disc coupling between the flywheel and transmission absorbs motor-

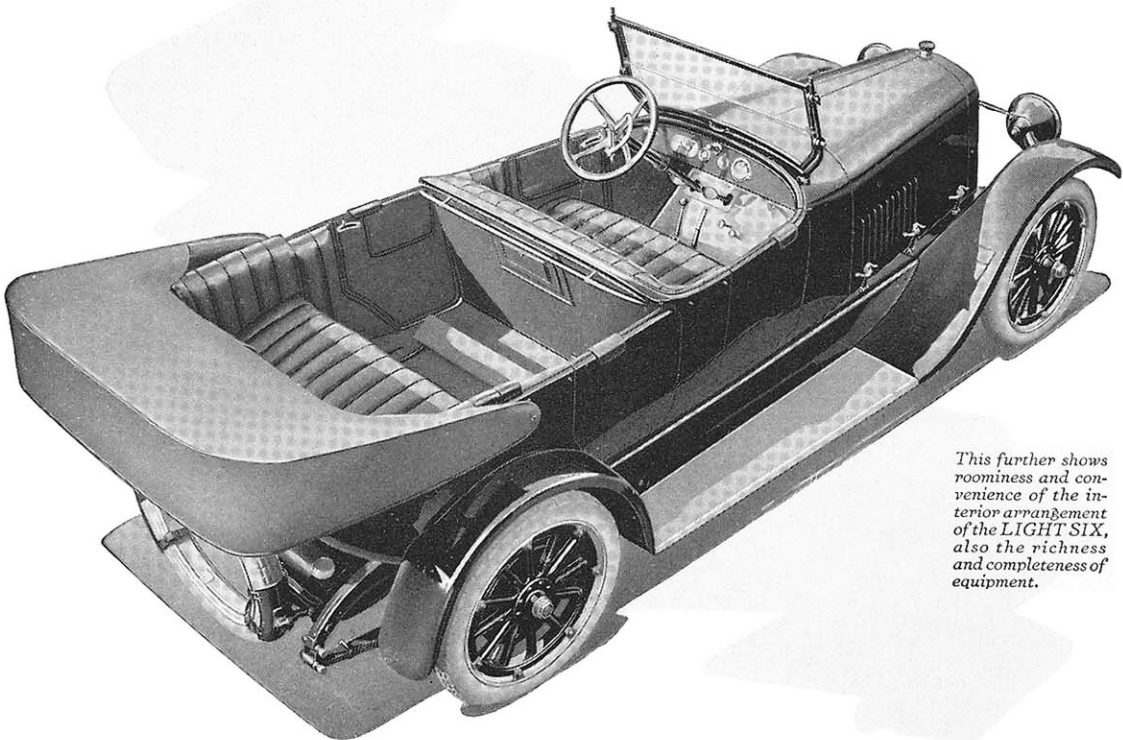

*This further shows roominess and convenience of the interior arrangement of the LIGHT SIX, also the richness and completeness of equipment.*

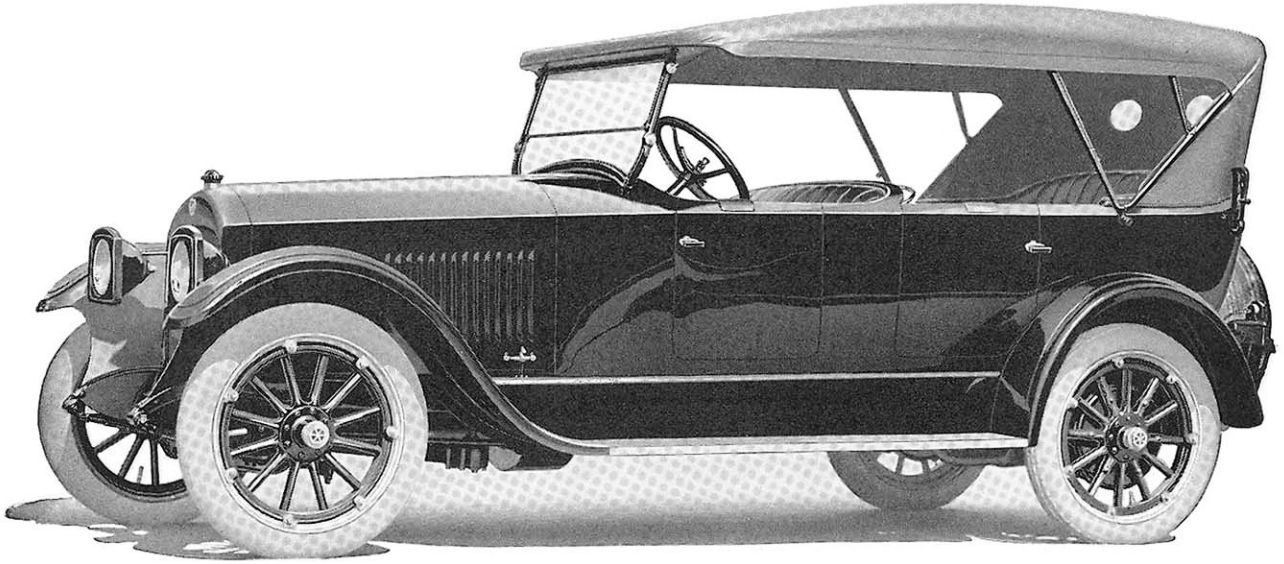

**THE BIG SIX—TOP UP**

*This view of the BIG SIX shows the blending harmony of the top, wind shield and body of this beautiful car.*

Here, in the new BIG SIX, is offered the finest seven-passenger car Studebaker has ever built. It is in every respect a quality car, intended as such, and for comparison only with the very best. The appointments of this car are of the best throughout. The long wheel base allows ample room for seven people. The lines are clean, simple, massive. The beautiful bevel-edge body is very smart. The whole impression of this beautiful car gives unmistakably an idea of the strength that has been put into it, and the well-nigh unlimited power it is ready to put forth at command. The extra-long rear springs, the absence of unsprung weight, the use of the Hotchkiss drive, and the way in which the power-application has been smoothed out, all contribute to give wonderful ease of travel. The splendid six-cylinder motor provides a source of power which levels grades without effort, at either low or high speeds. There is a delightful harmony in the evenness of its silent, steady pull; and, when the throttle is opened, the impression is that of great resources of speed and power.

shocks and prevents loss of power, reduces wear and better insures silent smooth transmission of power.

Back of the transmission are two of the well known Spicer joints, the best application of the universal joint principle, connecting the transmission with the rear axle through a staunch propeller-shaft.

By use of an improved Hotchkiss drive—"driving through the springs"—the car rides and drives far easier, and the wear on all parts is reduced and the power delivered with a high degree of smooth flexibility.

The placing of the transmission at an intermediate point in the chassis gives many advantages over the location in unit either with the rear axle or the motor.

By separating it from the motor, we eliminate the heavy unit housing of motor and transmission; we provide per-

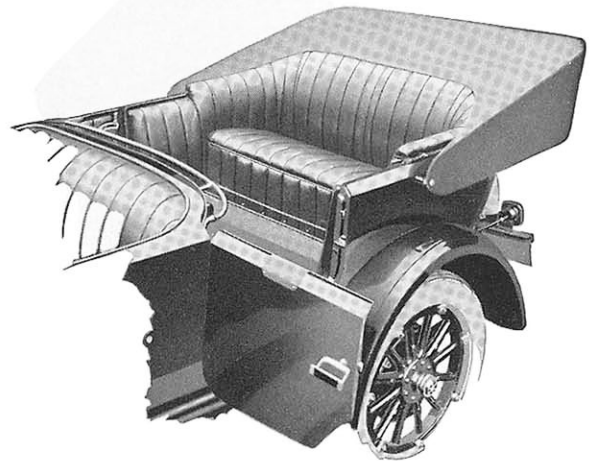

*This view suggests the beautiful French plaited upholstery used in Studebaker cars. It also shows the beveled edge at the top of the body; the jet black, silver white trimmed door handles.*

## THE NEW STUDEBAKER CARS • SERIES NINETEEN

fect accessibility to the clutch; we give much better balance by taking extra weight from the forward part of the car, and we provide a very much more flexible drive between the motor and the rear axle. Regardless of the roughness of roads, there is always a flexible alignment between the motor, transmission and rear axle; and this, from the standpoint of reduced wear and friction is in itself a sufficient reason why many of the highest priced cars use separate transmission units connected with the motor by flexible couplings.

Studebaker has developed a thoroughly new rear axle for its 19 Series cars and this has been done in collaboration with some of the most expert axle engineers.

The new Studebaker rear axle is of the improved semi-floating type which is now being used in some of the latest and best automobile and truck designs.

In this design powerful live axle-shafts of chrome-vanadium steel carry the load

on Timkin bearings; the rear-axle housing is practically immune to breakage, deflection or distortion; and the whole construction is strong, simple and trouble-proof. It is the most serviceable and satisfactory type that possibly could be developed for the owner-driver.

Oil-cups, because of their far more positive and convenient qualities, have replaced grease-cups practically throughout the entire car. Where these cups are necessarily in places hard to reach we have provided packed oil-pockets which will continue to distribute lubrication for long periods. A Studebaker improvement in design has made it impossible for the rear wheels, motor, or

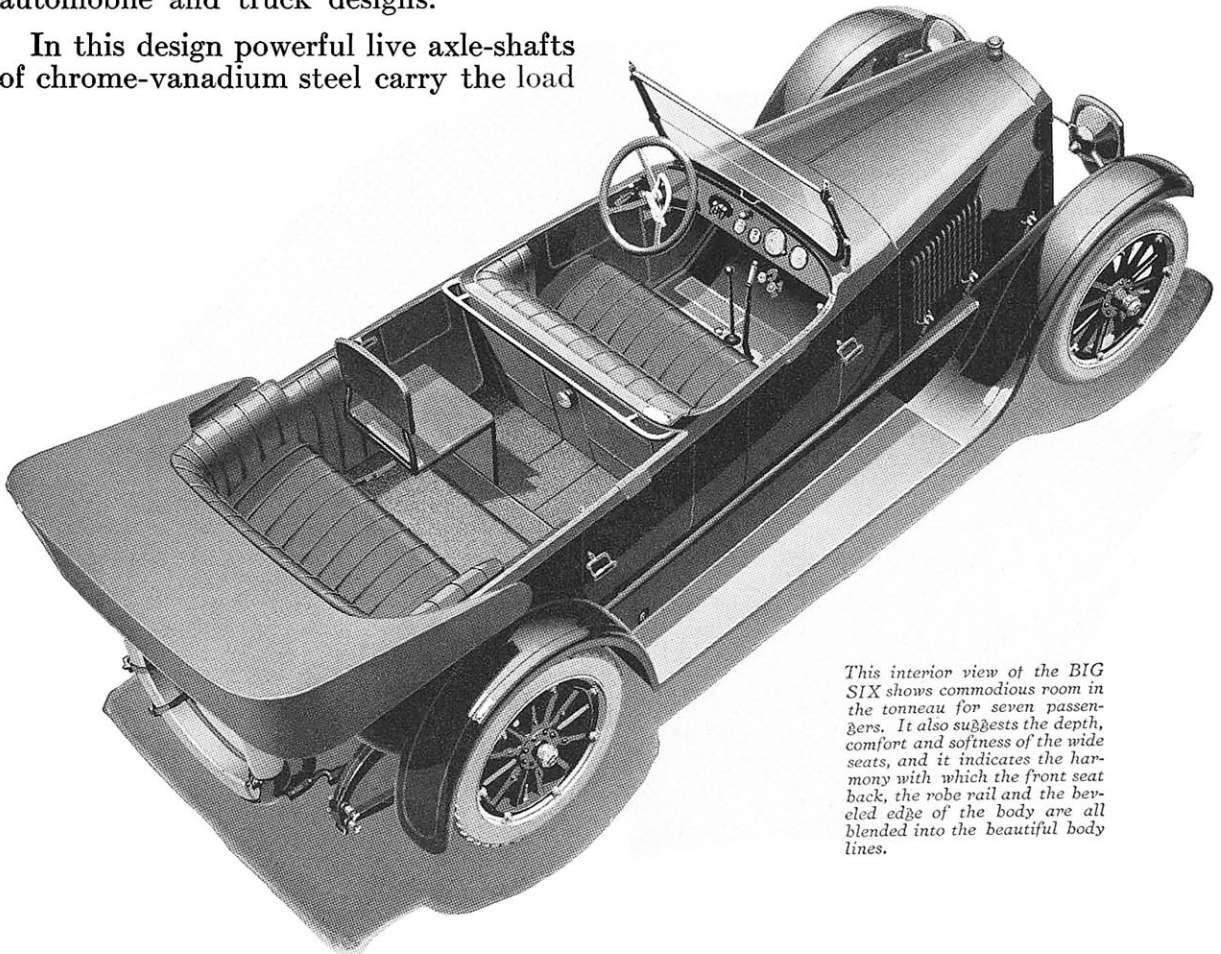

*This interior view of the BIG SIX shows commodious room in the tonneau for seven passengers. It also suggests the depth, comfort and softness of the wide seats, and it indicates the harmony with which the front seat back, the robe rail and the beveled edge of the body are all blended into the beautiful body lines.*

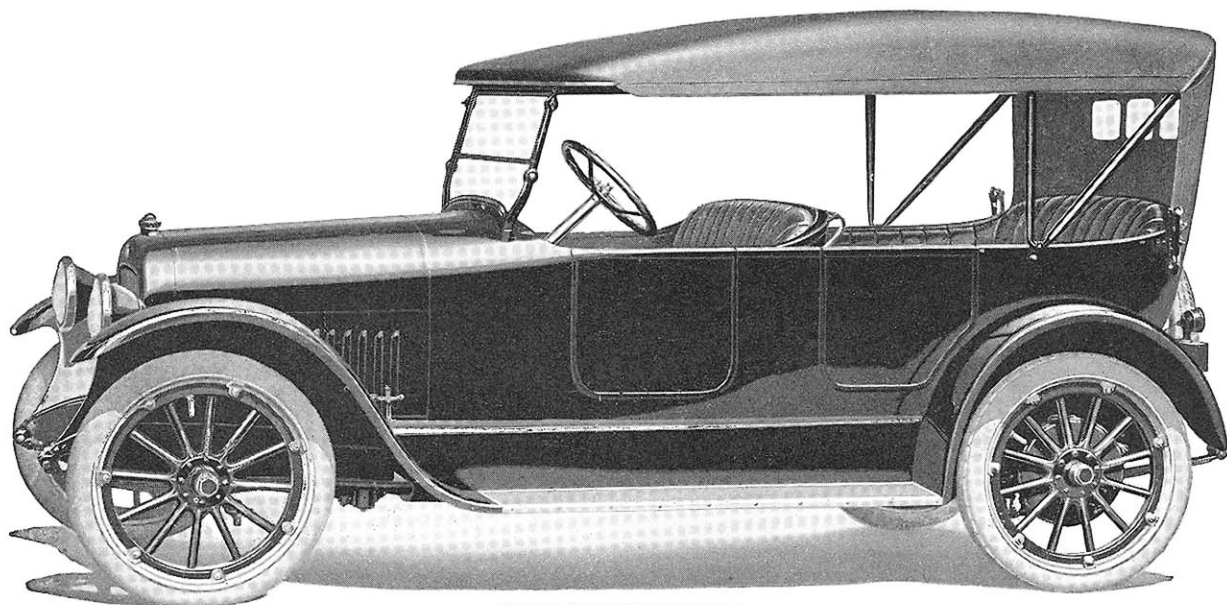

**THE LIGHT FOUR**

*This view of the LIGHT FOUR shows that the same distinctive and beautifully harmonious body lines of the more expensive models have been retained in the smaller and lighter FOUR. Neither the appearance nor the quality of this car have been sacrificed. In appearance and fact it stands in a class by itself.*

In this new five-passenger LIGHT FOUR, Studebaker offers a car which has been designed to fill a demand for a light-weight, economical, high-quality car which can be bought at a reasonable price, which is large and roomy enough to give comfort and convenience to five passengers, which is thoroughly high-grade in finish, equipment and appearance, and adequately beautiful in lines to satisfy even the very discriminating buyer. Therefore, the problem before the engineers in planning this car was to plan as good a four-cylinder car as expert skill, wide experience, and great engineering and factory resources would permit. Reasonable price also had to be taken into consideration, but this was made secondary to the quality and appearance of the car. The new Studebaker LIGHT FOUR is the result. It has been tested out in the experimental rooms, and 40,000 miles on the roads through the mountains of the United States and Canada, and finally on the Chicago Speedway. Tests have been made in comparison with the best known four-cylinder cars on the market. The results of every test have proved the power, speed, endurance and general mechanical excellence of this car.

transmission to leak and throw oil — a feature which every experienced motorist will gratefully appreciate.

The brakes are extra powerful; they take hold gradually but firmly. The brake bands maintain their true arc

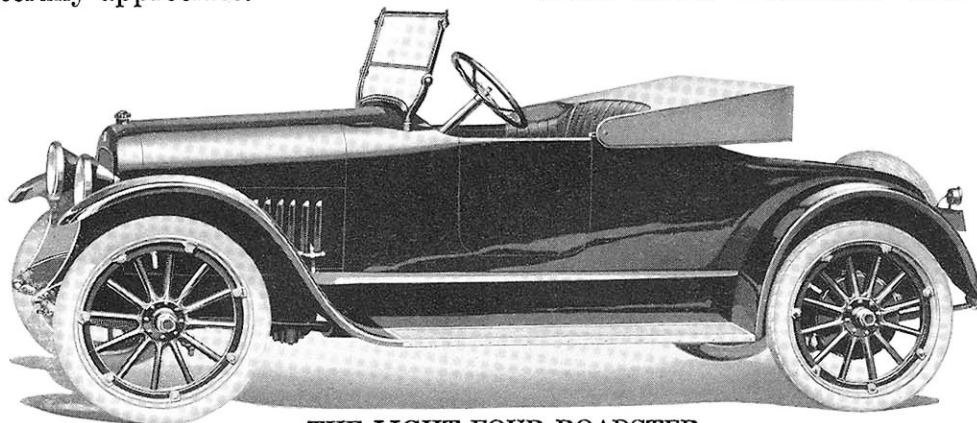

**THE LIGHT FOUR ROADSTER**

*Beautiful and distinctive lines have been retained in the roadster models. Quality and beautiful appearance are obtainable in this car at a remarkably low price.*



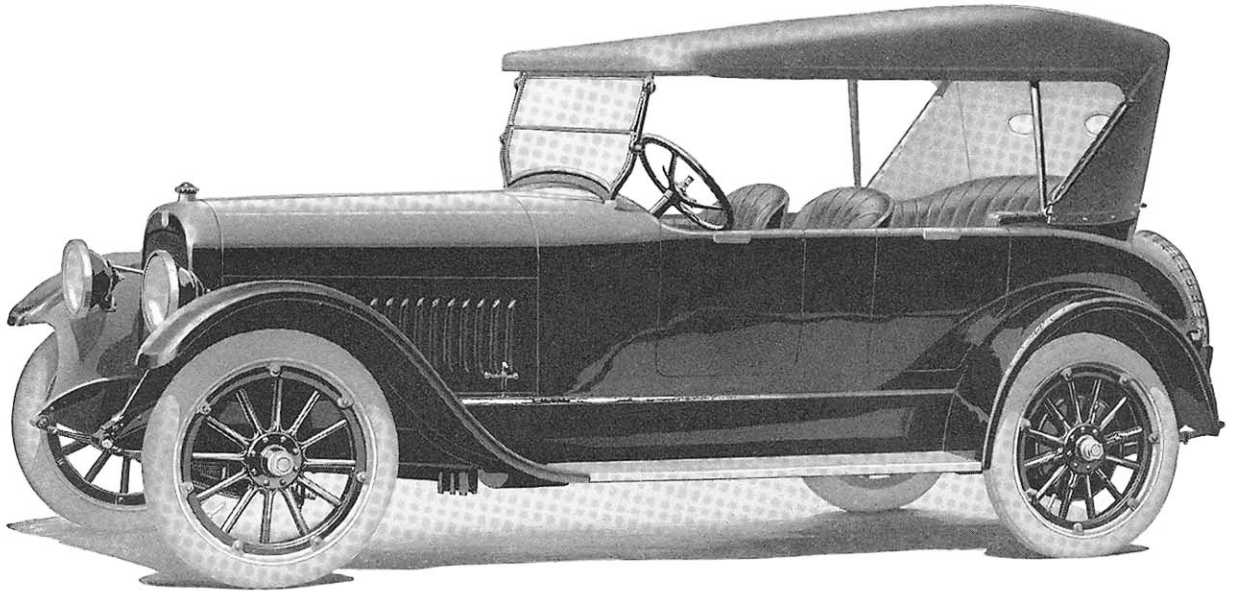

**THE LIGHT SIX FOUR-PASSENGER CLUB ROADSTER**

*Note that this four-passenger Roadster has doors opening both to the front seats and to the rear seats—a decided advantage. This car is more than a beautiful roadster—it is a light, cozy convenient four-passenger touring car, stylish and appealing in the extreme.*

permanently and can neither rattle nor bind. All spring-eyes are accurately bushed and pinned, and where the forward end of the rear spring is fastened rigidly to the frame, the spring bracket is broached to fit the spring to one one-thousandth of an inch.

The owner's convenience is provided for at every point. The fan-belt ad-

justment, for instance, is quick and positive, involving only the turning of a single screw. The battery is instantly accessible by raising the floor-boards. The conduits and cable ends are provided with universal terminals, fitting any battery. These, and a score of other little details which make for an owner's satisfaction, have received the most painstaking care.

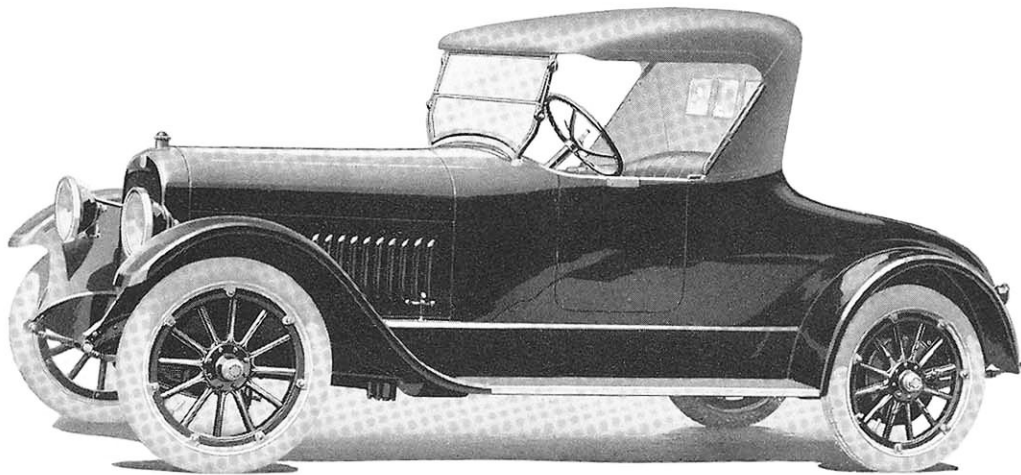

**THE LIGHT SIX ROADSTER**

*This car offers everything that can be desired in a roadster: power—speed—style—beauty. The seats of both the LIGHT SIX and LIGHT FOUR roadsters are unusually wide and will accommodate three passengers if need be.*

## Mechanical Description in Detail

**MOTORS** are L-head, with cylinders cast en-bloc. The cylinder head on the **BIG SIX** is demountable; on the **LIGHT SIX** and **LIGHT FOUR** cast integral. Crank-shafts are four-bearing on the two **SIXES**, and three-bearing on the **LIGHT FOUR**, of oversize high-grade forging steel doubly heat-treated and ground as are the cam shafts on all models. The valve push-rods are mushroom type, located on the left side, and entirely enclosed. Valve lifts have been increased from  $\frac{1}{4}$  inch to  $\frac{5}{16}$  inch. Push-rods and guides are easily removable as a unit. All moving motor parts are scientifically balanced to reduce vibration to a minimum.

**LUBRICATION** is by splash and positive distributing system. There is no waste of oil, as it is pumped through a perfect screening system—easily removable for cleaning—and stored in the reservoir formed by the lower half of the crank-case. Since there is no dust pan below this, the supply of oil is kept at a cool, effective temperature, and delivered, cool and clean, to the bearings. Oil-cups have almost entirely replaced grease-cups throughout the car, with packed grease-cups in inaccessible places.

**CARBURETION**—The Schebler carburetor is used on the **LIGHT FOUR**, the Ball & Ball carburetor on the **LIGHT SIX** and **BIG SIX** models. The

“hot-spot” intake manifold gives highest vaporization of fuel and the scientific shape of the manifold, a correct mechanical distribution of gases, resulting in greater engine-power and increased fuel-economy.

**COOLING** is by centrifugal force pump circulating system with new tubular radiator and large four-blade fan. The fan-belt is provided with new type of instant and positive adjustment. All passages within the motor are of ample size to give perfect results in all climates and under all conditions of service. The radiator is of specially strong construction and protected from road-shocks by spring fastenings.

**ELECTRICAL SYSTEM**—Ignition is by generator and storage battery, with 6-volt, 100-ampere hour Willard battery and Remy coil and distributor. The latter is provided with a waterproof cap. Improved shape of cam in distributor gives a hotter spark and more perfect ignition. Starting and lighting is by the two-unit Studebaker-Wagner system. The whole wiring assembly is carried on the chassis and may be removed as a unit. All wires lead to an accessible junction block terminal at the right side of motor. Head-lights are provided with two degrees of dimming. Studebaker improved types of deflecting and dif-fusing lenses are furnished on the head-lights.

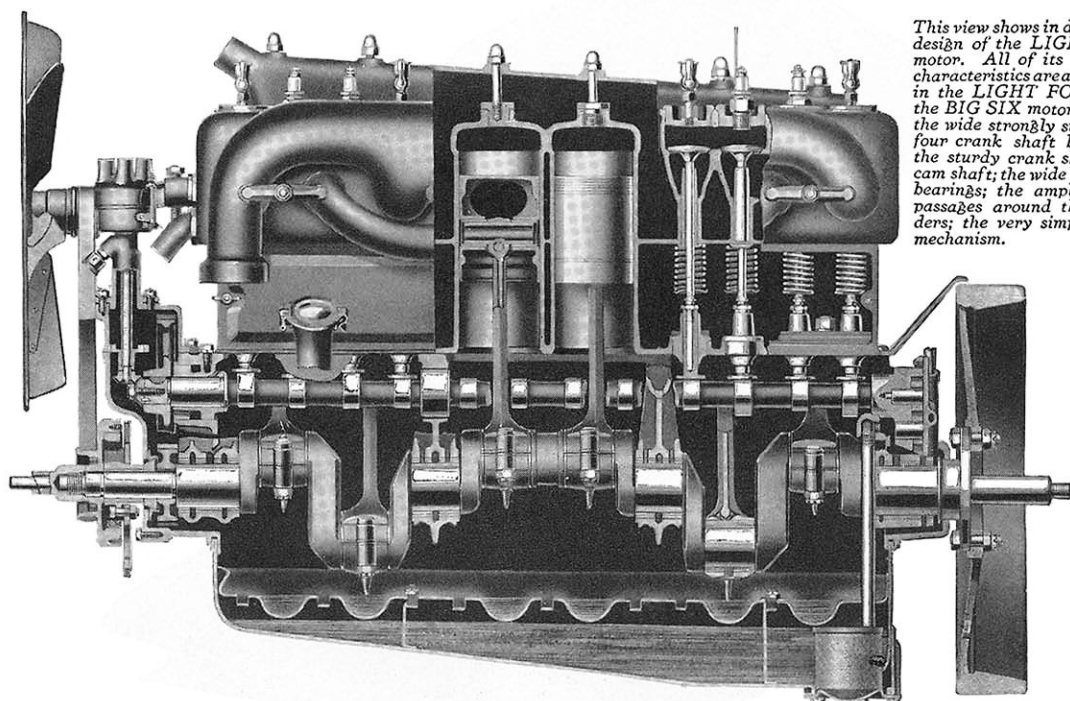

*This view shows in detail the design of the LIGHT SIX motor. All of its essential characteristics are also found in the LIGHT FOUR and the BIG SIX motors. Note the wide strongly supported four crank shaft bearings; the sturdy crank shaft and cam shaft; the wide wrist pin bearings; the ample water passages around the cylinders; the very simple valve mechanism.*

THE NEW STUDEBAKER CARS ▾ SERIES NINETEEN

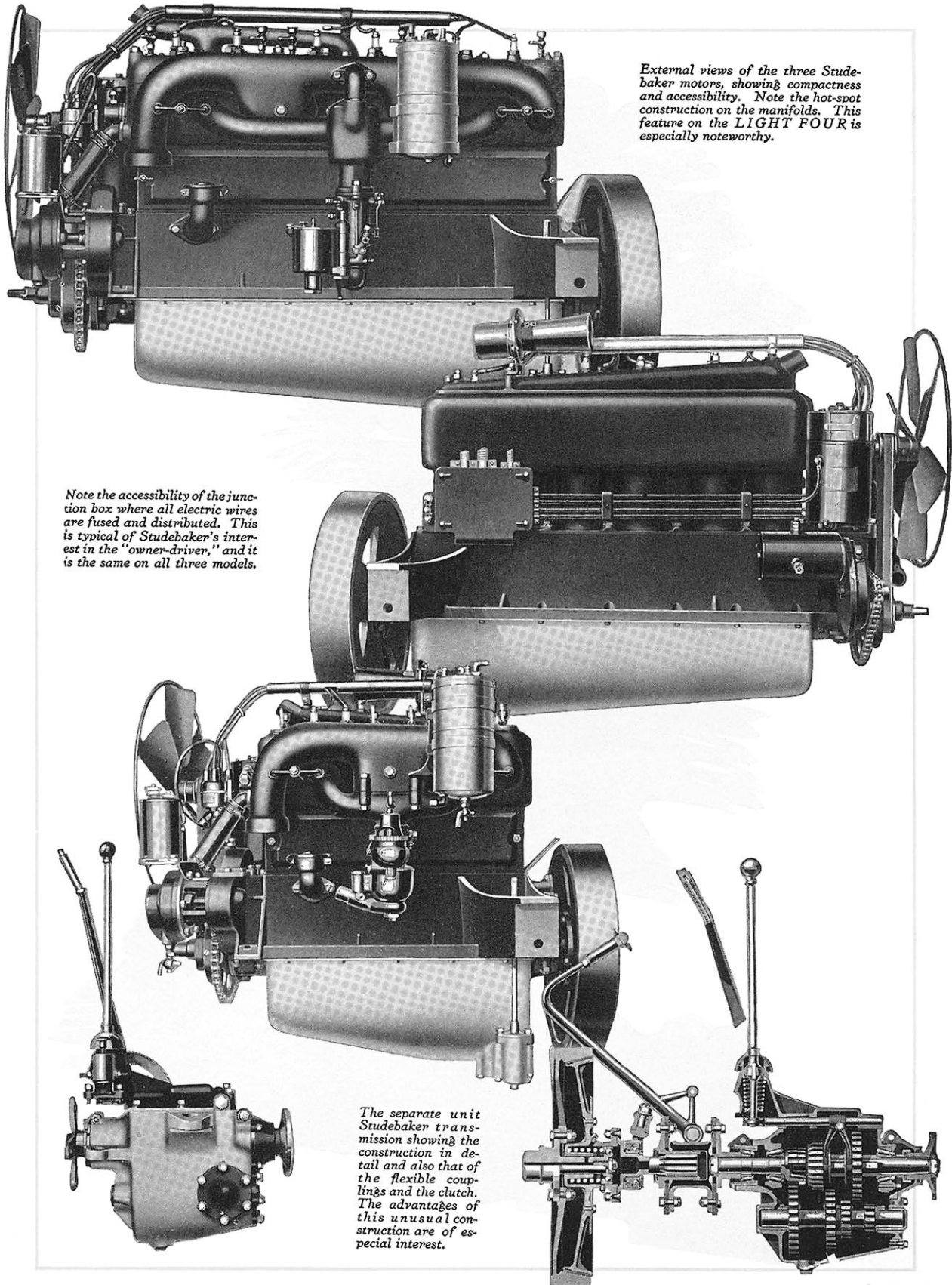

*External views of the three Studebaker motors, showing compactness and accessibility. Note the hot-spot construction on the manifolds. This feature on the LIGHT FOUR is especially noteworthy.*

*Note the accessibility of the junction box where all electric wires are fused and distributed. This is typical of Studebaker's interest in the "owner-driver," and it is the same on all three models.*

*The separate unit Studebaker transmission showing the construction in detail and also that of the flexible couplings and the clutch. The advantages of this unusual construction are of especial interest.*

Cable terminals are of universal type, fitting all batteries. All controls lead to the instrument board, and the ignition control is Yale-locked.

**TRANSMISSION** is three-speed sliding gear, and reverse, located at an intermediate point in the chassis, and supported by an extension of the sub-frame mounting which carries the rear of the motor. There are four adjustable Timken bearings in the transmission. The usual three-jawed clutch is replaced by the cutting of the second speed gear with internal teeth, which engage with the main drive pinion when in high gear, resulting in easy, quiet gear-shifting. All transmission gears are chrome-nickel steel, carbonized, hardened and ground, and have short, stub-teeth. Special felt packing glands prevent oil-leakage from the transmission case.

**CONTROL** is by universal-action ball-and-socket cane lever, centrally located and directly over the transmission. The gas and spark-levers are located on the steering wheel, and accelerator in the toe-board. Adjustable clutch and brake-levers of unusually easy action are conveniently placed. The emergency brake lever is also easily accessible at the driver's right hand. The electric horn button is at the top of the steering column. Special attention is directed to the ease with which these new cars can be handled by women drivers, this particularly so because of the ease with which gears can be shifted, the accessibility of all control devices, and the way in which the car stays in the road without effort.

**CLUTCH**—The clutch cone on the new cars is aluminum, leather-faced. A device has been

provided which automatically prevents the clutch from spinning, when released, thus facilitating easy gear-changing. A new clutch-equalizer prevents the clutch from binding when the pedal is depressed.

**REAR AXLE** is an improved semi-floating type. This consists of a very strong housing, practically immune to breakage, and two large-diameter chrome-vanadium steel live shafts running on Timken bearings, designed with a high factor of safety over all bending stresses to which it can normally be subjected. The housing is made in halves, welded together with inner tube reinforcement. The whole construction is practically trouble-proof. Ring-gear and driving-pinion are cut with spiral bevel teeth, and the differential side-pinions and gears have been doubled in strength by using stub teeth of coarser pitch. The axle on the **LIGHT FOUR** is proportionately smaller and lighter than that used on the two **SIXES** but is of similar design. Complete Timken bearing equipment is used throughout.

**BRAKES** are external contracting and internal expanding for service and emergency, respectively. The brake drums on the **SIXES** are  $14\frac{15}{16}$  by 2 inches; on the **LIGHT FOUR**  $14\frac{1}{16}$  by 2 inches. The service brake is carefully equalized. Brake-linings are of multibestos. Particular attention has been given to make the brake adjustment very simple, accessible and permanent.

**FRONT AXLE**—The front axle is unit forged from high grade forging-steel and specially heat-treated. The steering knuckles are designed scientifically correct to assure very easy steering

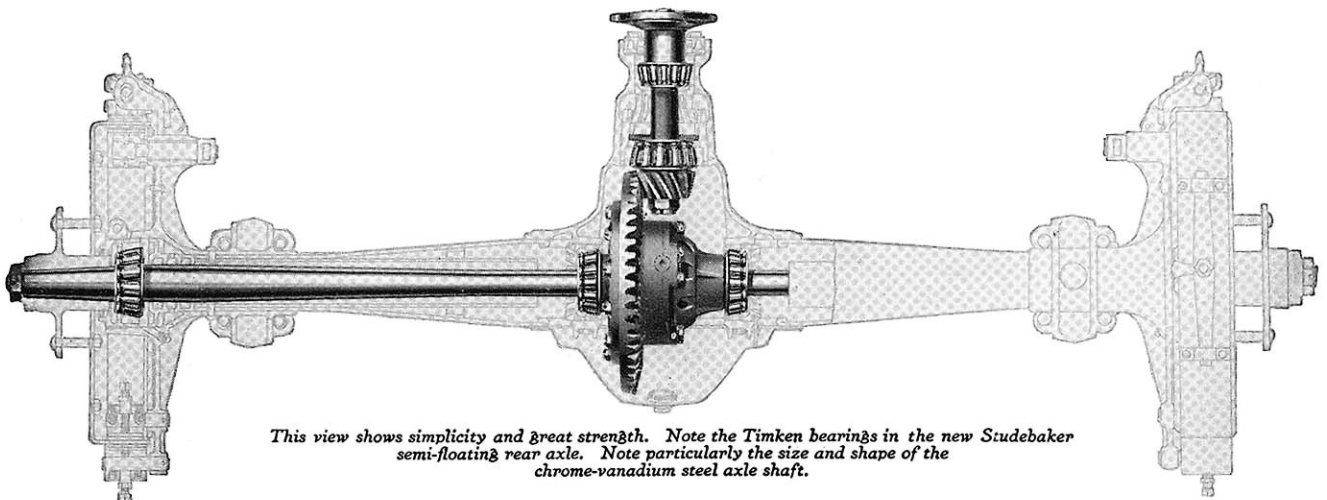

*This view shows simplicity and great strength. Note the Timken bearings in the new Studebaker semi-floating rear axle. Note particularly the size and shape of the chrome-vanadium steel axle shaft.*

THE NEW STUDEBAKER CARS ▾ SERIES NINETEEN

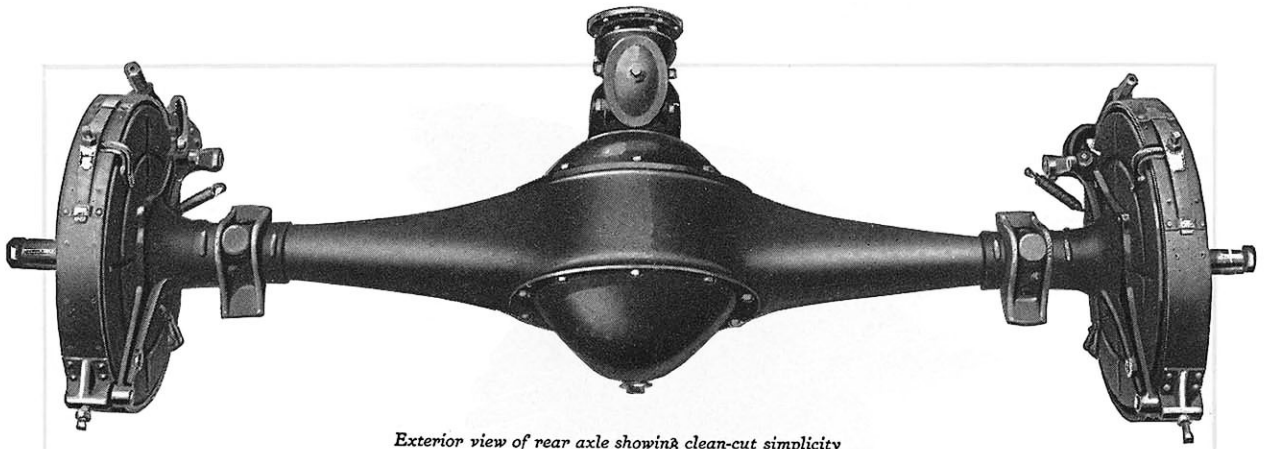

*Exterior view of rear axle showing clean-cut simplicity*

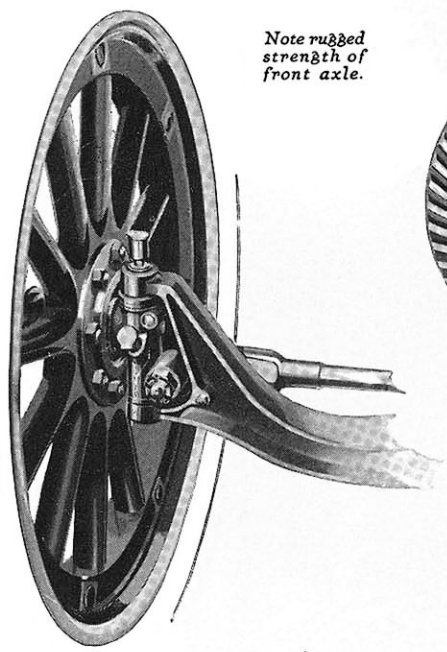

*Note rugged strength of front axle.*

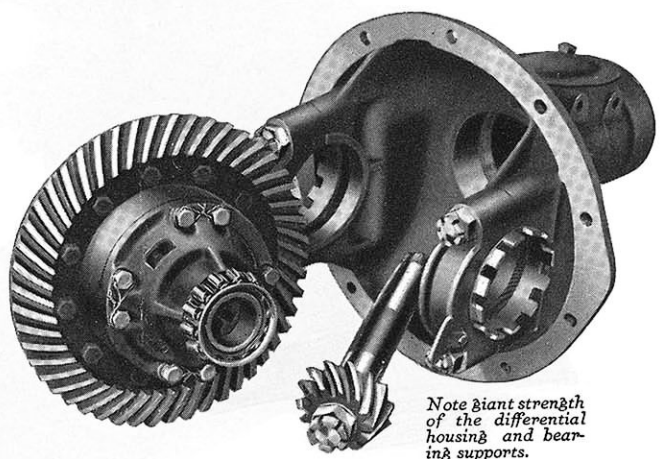

*Note giant strength of the differential housing and bearing supports.*

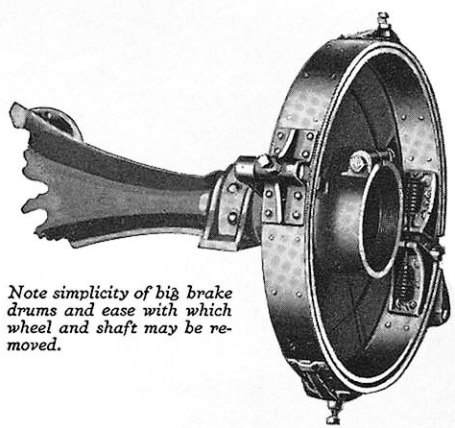

*Note simplicity of big brake drums and ease with which wheel and shaft may be removed.*

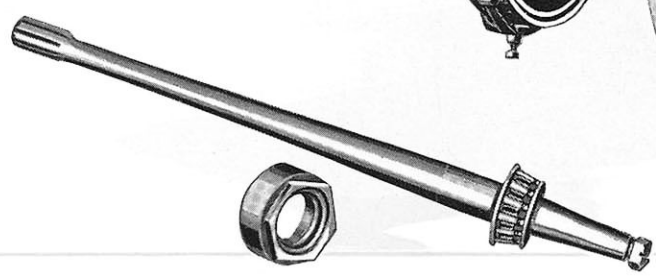

## THE NEW STUDEBAKER CARS ▾ SERIES NINETEEN

and to make the car hang to the road at all speeds; the steering gear is "irreversible" which means that road shocks cannot be transmitted to the steering wheel. Each front wheel revolves on two Timken bearings.

**SPRINGS** on all models are semi-elliptic, underslung in the rear, and of best quality vanadium steel, unusually long. All spring-eyes are bronze-bushed to prevent wear and noise. The forward ends of the rear springs, which are fastened rigidly to the frame, have flanged bushings to give greater bearing surface to prevent wear and insure better and more permanent fit. These bushings are fitted to one one-thousandth of an inch. All springs are directly under the frame. Springs on the **LIGHT FOUR** are 50¼ by 2 inches in rear with 7 leaves, and 34½ by 1¾ inches in front with 7 leaves. On the **LIGHT SIX** 56 by 2 inches in rear with 8 leaves, and 38 by 2 inches in front with 7 leaves. On the **BIG SIX** 56 by 2 inches in rear with 9 leaves, and 38 by 2 inches in front with 8 leaves.

**CHASSIS** as a whole has unusual strength, simplicity, and accessibility. Extra deep channel section side and cross members make it very resistant not only to vertical road shocks but also to severe horizontal stresses. These chassis have strength enough beyond their "safety factor" provision to support any style of closed body without reinforcement. Bodies rest directly on the frame from end to end, and the narrowed front of the chassis gives a firmer motor support and a shorter turning radius.

### MOTOR AND TRANSMISSION MOUNTING

The rear of the motor is mounted on a sub-frame which also carries the transmission, thus giving all the advantage of the unit power plant but with a better distribution of weight, flexibility and greater accessibility to the clutch. This method of still preserving unity between the motor and transmission and at the same time assuring flexibility and smoother application of power with better distribution of weight, has been used in the past almost exclusively by high priced cars.

## The Studebaker Corporation of America

South Bend, Indiana      Detroit, Michigan  
Walkerville, Ontario

*Address all communications to South Bend, Indiana*

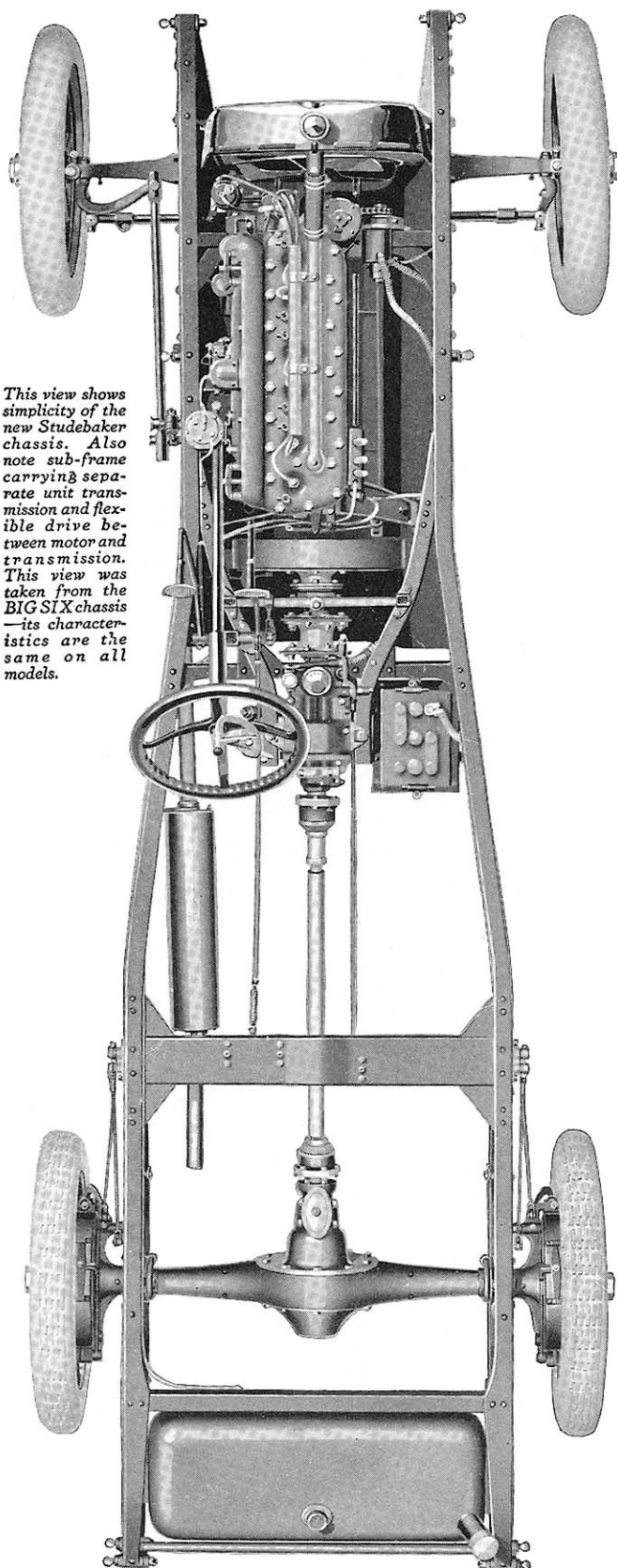

*This view shows simplicity of the new Studebaker chassis. Also note sub-frame carrying separate unit transmission and flexible drive between motor and transmission. This view was taken from the BIG SIX chassis—its characteristics are the same on all models.*

# Specifications

## BIG SIX

**SEATING CAPACITY**—Seven passengers.  
**WHEELBASE**—126 inches.  
**MOTOR**—Six cylinders, cast en-bloc, L-head, demountable, 3 $\frac{3}{8}$ " x 5"; 60-65 H. P., at 2,000 R. P. M.  
**LUBRICATION**—Splash and positive distribution.  
**COOLING SYSTEM**—Centrifugal force pump circulating system; tubular radiator, 18-inch, four-blade fan.  
**GASOLINE SYSTEM**—17-gallon tank in rear. Vacuum feed.  
**CARBURETION**—Carburetor, with new hot-spot intake manifold.  
**ELECTRIC SYSTEM**—Two-unit Studebaker-Wagner.  
**IGNITION**—Generator-storage battery ignition, with Remy coil and distributor.  
**ELECTRIC LIGHTS**—Large headlights with improved deflecting and diffusing lenses, two degrees of dimming, speedometer light, tonneau light with convenient extension; tail light.  
**CLUTCH**—Aluminum leather-faced cone, with anti-spin brake.  
**TRANSMISSION**—Separate unit—three speeds forward, and reverse.  
**GEAR RATIO**—3.71 to 1.  
**REAR AXLE**—Studebaker improved semi-floating, spiral bevel gear drive, full Timken bearing equipment.  
**DRIVE**—Hotchkiss.  
**SPRINGS**—Front and rear semi-elliptic. Front, 38 x 2 inches, 8 leaves; rear, 56 x 2 inches, 9 leaves, underslung.  
**TIRES**—33 x 4 $\frac{1}{2}$  inches; safety tread on rear.  
**BRAKES**—Foot brake, external contracting, 14 $\frac{1}{8}$ " x 2"; emergency brake, internal expanding, 14 $\frac{1}{8}$ " x 1 $\frac{3}{4}$ ".  
**FENDERS**—Heavy pressed steel, double crown design.  
**UPHOLSTERY**—Genuine hand-buffed leather, French plaited.  
**TOP**—One-man Gypsy type, bevel French plate glass windows in rear, curtains open with the doors.  
**EQUIPMENT**—Rain vision slanting windshield; 3 $\frac{1}{2}$ -inch carpet-covered foot rest in tonneau; electric horn; electrically lighted mahogany instrument board, on which are mounted Warner speedometer—driven from propeller shaft—oil indicator, Yale-locked ignition and lighting switch; carburetor control; ammeter; clock; combination robe and hand rail extending full width of front seat; mahogany glove box, with lock, in back of front seat; gasoline gauge on tank in rear; complete set of tools; double tire carrier at the rear, with extra rim.  
**COLORS**—Choice of two colors—dark green and maroon.  
**MODEL**—Touring car,

## LIGHT SIX

**SEATING CAPACITY**—Five passengers.  
**WHEELBASE**—119 inches.  
**MOTOR**—Six cylinders, cast en-bloc, L-head; 3 $\frac{1}{2}$ " x 5"; 45-50 H. P., at 2,000 R. P. M.  
**LUBRICATION**—Splash and positive distribution.  
**COOLING SYSTEM**—Centrifugal force pump circulating system; tubular radiator, 18-inch, four-blade fan.  
**GASOLINE SYSTEM**—17-gallon tank in rear. Vacuum feed.  
**CARBURETION**—Carburetor, with new hot-spot intake manifold.  
**ELECTRIC SYSTEM**—Two-unit Studebaker-Wagner.  
**IGNITION**—Generator-storage battery ignition, with Remy coil and distributor.  
**ELECTRIC LIGHTS**—Large headlights with improved deflecting and diffusing lenses, two degrees of dimming, speedometer light, tail light.  
**CLUTCH**—Aluminum leather-faced cone clutch, with anti-spin brake.  
**TRANSMISSION**—Separate unit—three speeds forward, and reverse.  
**GEAR RATIO**—4 to 1.  
**REAR AXLE**—Studebaker improved semi-floating, spiral bevel gear drive, full Timken bearing equipment.  
**DRIVE**—Hotchkiss.  
**SPRINGS**—Front and rear semi-elliptic. Front, 38 x 2 inches, 7 leaves; rear, 56 x 2 inches, 8 leaves, underslung.  
**TIRES**—32 x 4 inches; safety tread on rear.  
**BRAKES**—Foot brake, external contracting, 14 $\frac{1}{8}$ " x 2"; emergency brake, internal expanding, 14 $\frac{1}{8}$ " x 1 $\frac{3}{4}$ ".  
**FENDERS**—Heavy pressed steel, oval crown design.  
**UPHOLSTERY**—Genuine French plaited leather.  
**TOP**—One-man Gypsy type, bevel French plate glass windows in rear; curtains open with the doors.  
**EQUIPMENT**—Rain vision slanting windshield; 3 $\frac{1}{2}$ -inch carpet-covered foot rest in tonneau; electric horn; electrically lighted mahogany instrument board, on which are mounted Stewart-Warner speedometer—driven from propeller shaft—oil indicator, Yale-locked ignition and lighting switch; carburetor control; battery indicator; combination robe and hand rail extending full width of front seat; mahogany glove box, with lock, in back of front seat; gasoline gauge on tank in rear; complete set of tools; tire carrier at rear, with extra rim.  
**COLORS**—Choice of two colors—blue and maroon.  
**MODELS**—Touring car, four-passenger roadster, three-passenger roadster, and Sedan.

## LIGHT FOUR

**SEATING CAPACITY**—Five passengers.  
**WHEELBASE**—112 inches.  
**MOTOR**—Four cylinders, cast en-bloc, L-head, 3 $\frac{1}{2}$ " x 5"; 35-40 H. P., at 2,000 R. P. M.  
**LUBRICATION**—Splash and positive distribution.  
**COOLING SYSTEM**—Centrifugal force pump circulating system; tubular radiator, 17-inch, four-blade fan.  
**GASOLINE SYSTEM**—14-gallon tank in rear. Vacuum feed.  
**CARBURETION**—Carburetor, with new hot-spot intake manifold.  
**ELECTRIC SYSTEM**—Two-unit Studebaker-Wagner.  
**IGNITION**—Generator-storage battery ignition, with Remy coil and distributor.  
**ELECTRIC LIGHTS**—Large headlights with improved deflecting and diffusing lenses, two degrees of dimming, speedometer light, tail light.  
**CLUTCH**—Aluminum leather-faced cone clutch, with anti-spin brake.  
**TRANSMISSION**—Separate unit—three speeds forward, and reverse.  
**GEAR RATIO**—4.36 to 1.  
**REAR AXLE**—Studebaker improved semi-floating, spiral bevel gear drive, full Timken bearing equipment.  
**DRIVE**—Hotchkiss.  
**SPRINGS**—Front and rear semi-elliptic. Front, 34 $\frac{1}{2}$  x 1 $\frac{3}{4}$  inches, 7 leaves; rear, 50 $\frac{1}{4}$  x 2 inches, 7 leaves, underslung.  
**TIRES**—32 x 3 $\frac{1}{2}$  inches; safety tread on rear.  
**BRAKES**—Foot brake, external contracting, 14 $\frac{1}{8}$ " x 2"; emergency brake, internal expanding, 13 $\frac{3}{4}$ " x 1 $\frac{3}{4}$ ".  
**FENDERS**—Pressed steel, crown design.  
**UPHOLSTERY**—French plaited upholstery.  
**TOP**—One-man; curtains open with the doors.  
**EQUIPMENT**—Rain vision slanting windshield; 3 $\frac{1}{2}$ -inch carpet-covered foot rest in tonneau; electric horn; electrically lighted instrument board on which are mounted Stewart-Warner speedometer—driven from propeller shaft—oil indicator; Yale-locked ignition and lighting switch; carburetor control; battery indicator; combination robe and hand rail extending full width of front seat; gasoline gauge on tank in rear; complete set of tools; tire carrier at rear, with extra rim.  
**COLOR**—Dark blue.  
**MODELS**—Touring, three-passenger roadster, and Sedan.  
 (The Specifications, as shown on this page, subject to change.)

Side view of LIGHT SIX chassis showing strength, compactness, accessibility.

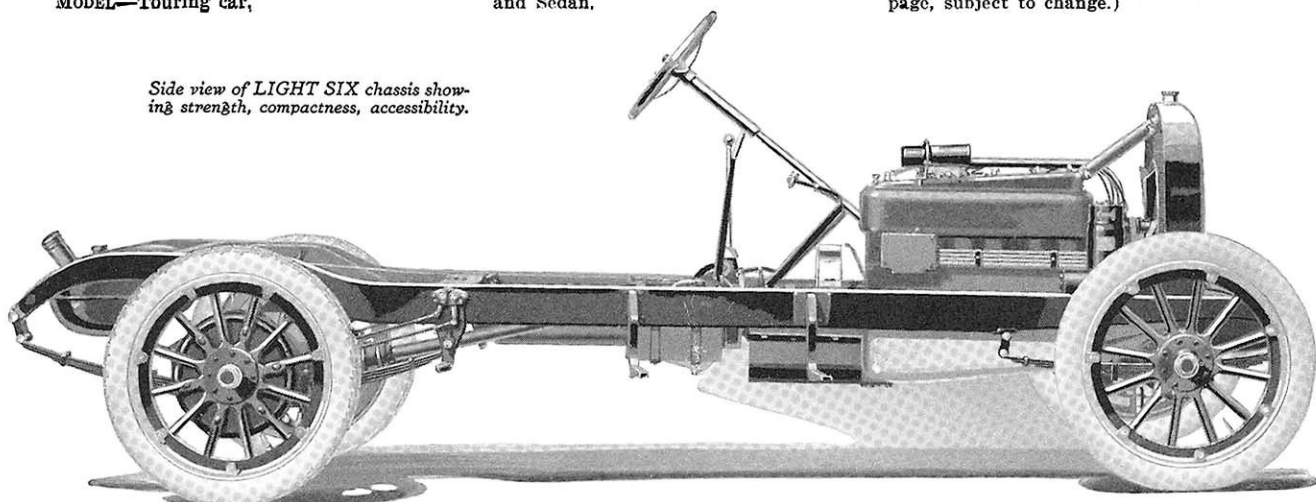

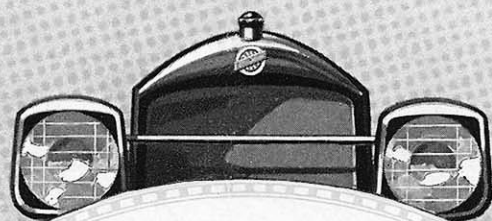

Beautiful in Design  
Thoroughly Modern  
Mechanically Right

Series 19

*The Studebaker Corporation  
of America*

