

# TRUCK SALES INFORMATION

---

*Packard*

MOTOR TRUCKS



Illustrations of the  
E Packard Truck

---

*Number 4 Issued Dec., 1919*

Property of  
Packard Motor Car Company  
Detroit, Michigan

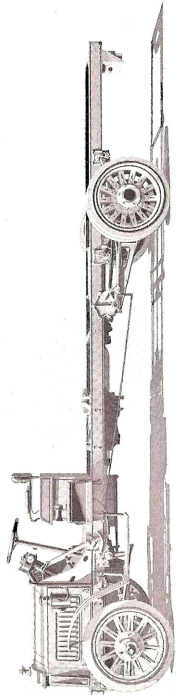

Side Elevation Standard 3-E Chassis

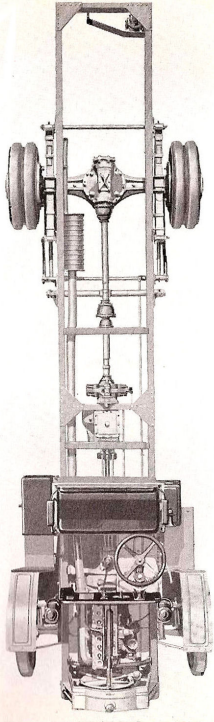

Plan View Standard 5-E Chassis

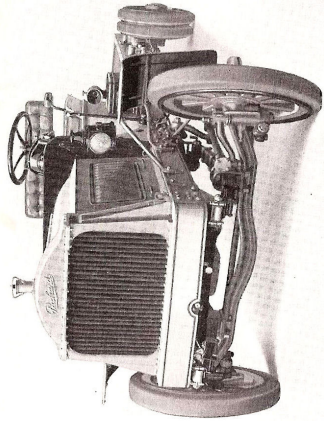

Chassis—Front End  
Note Radiator Suspension and Rigid Fender Mounting

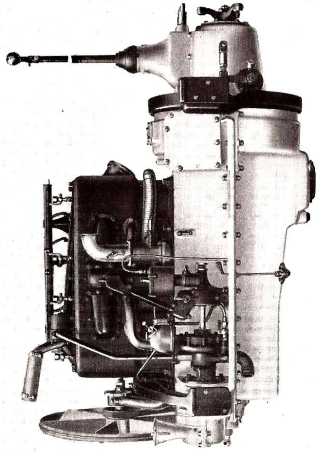

Motor—Left Side  
Unit Power Plant Contains Motor Clutch and Transmission

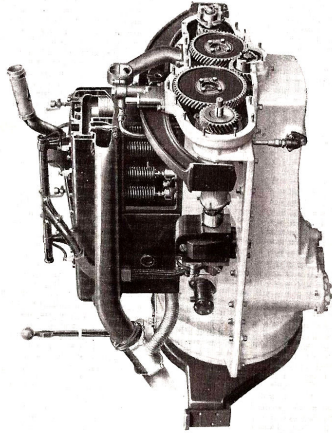

Motor—Right Side  
Showing Section through Cylinder with Gear Case and Valve Cover Removed

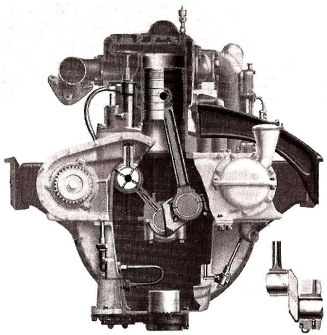

Motor—Cross Section  
Showing Lubrication System

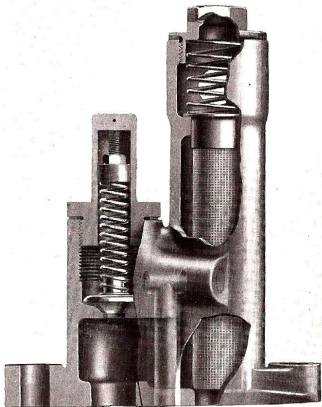

Oil Pressure and Relief Valve

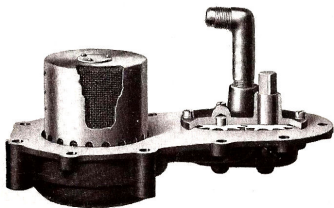

The Gear Oil Pump

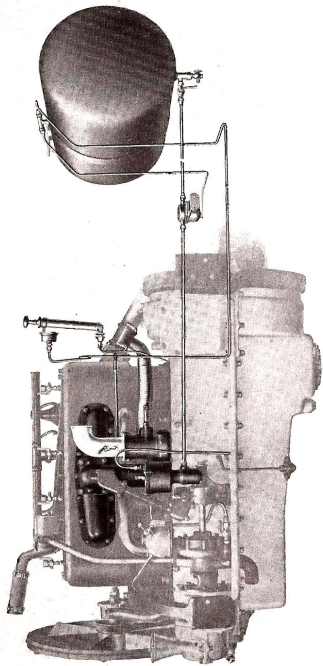

Pressure Feed Gasoline System

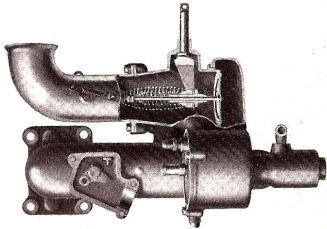

Section Through Air Valve

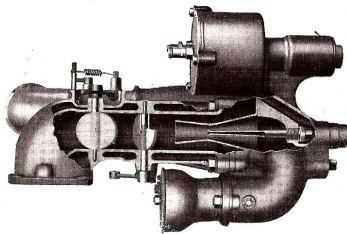

Carburetor  
Section Through Mixing Chamber

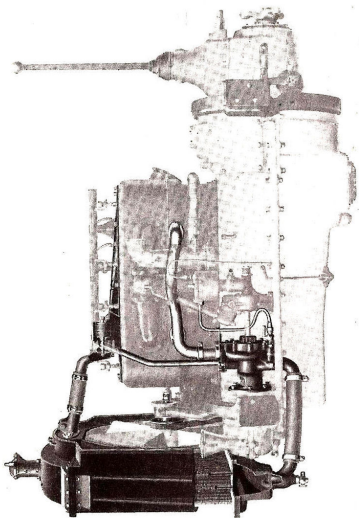

Cooling System  
Showing Section Through Radiator and Thermostat

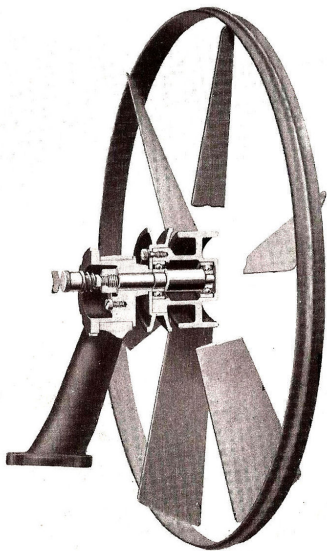

Radiator Fan

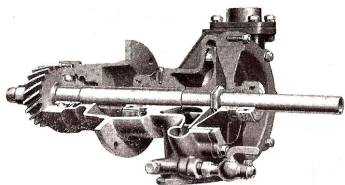

Motor Water Pump

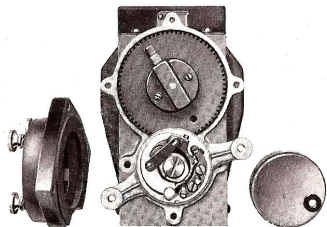

Magneto

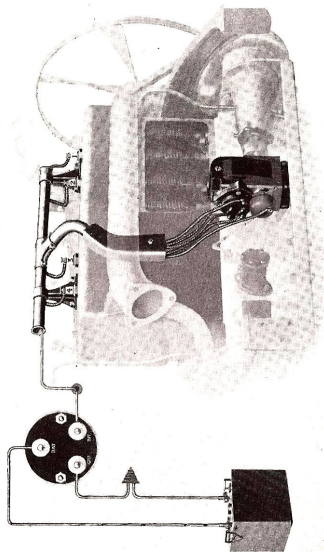

Ignition System



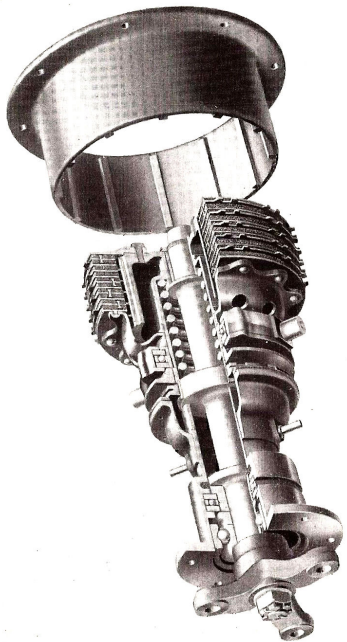

Clutch  
Multiple Disc Dry Plate Type

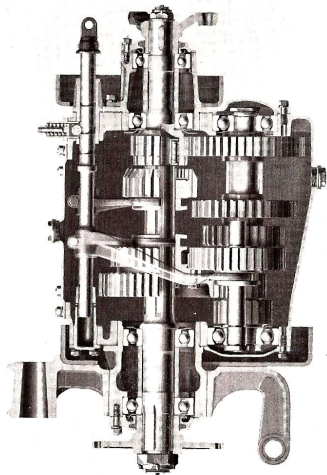

Transmission  
Four-Speed Selective Sliding Type

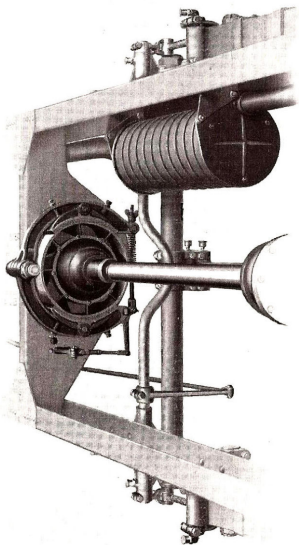

Service Brake and Brake Connections

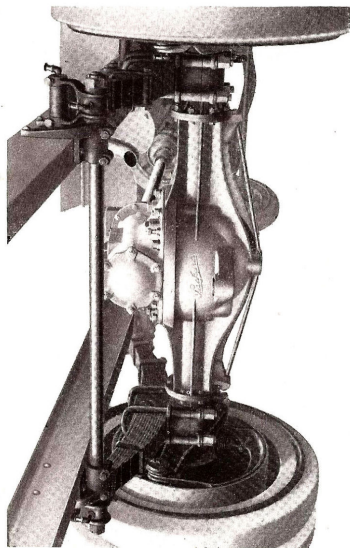

Rear Axle  
Showing Oil Filler, Rear Spring Trunnions and Mounting of Differential Carrier

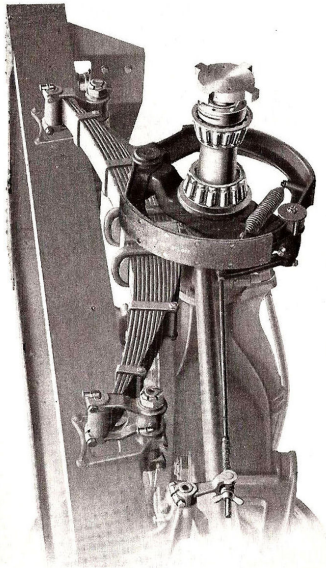

Rear Axle with Wheel Removed  
Showing Radius Rods, Emergency Brake, Hub End of Axle Shaft and Rear Spring Suspension

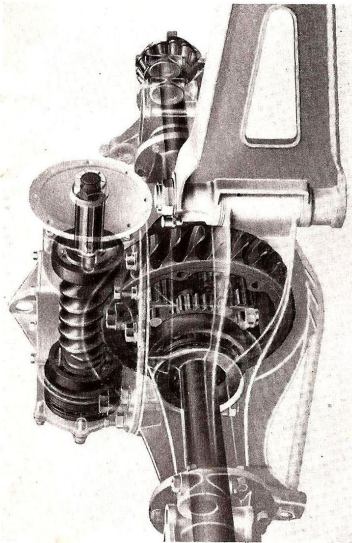

Rear Axle  
Showing Mounting of Worm and Wheel, Differential Gear and Driving Shafts

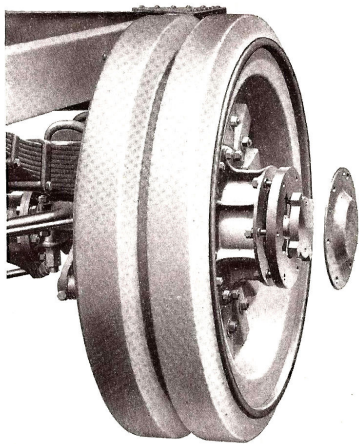

Rear Wheel Drive  
Universal Joint Action Eliminates Bending Stresses

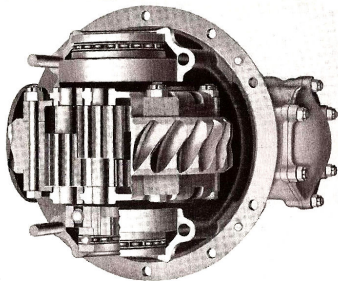

Differential and Carrier

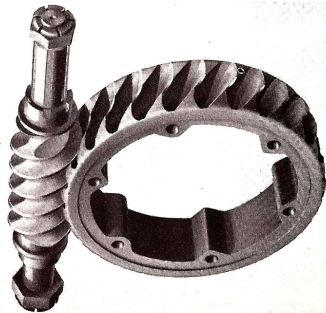

Driving Worm and Wheel

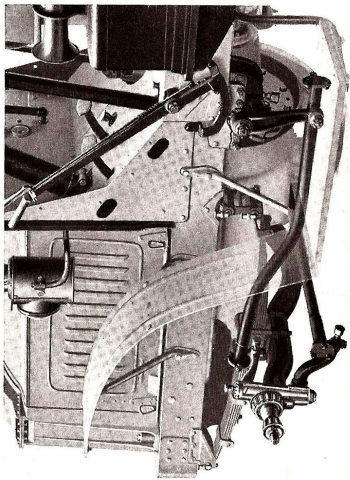

Front Axle and Chassis Parts

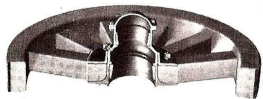
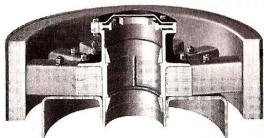

Front and Rear Wheels

Packard Motor Car Company

Detroit, Michigan

Detroit Detroit Detroit