

FORD

**O·H·V
V8**

**TRIPLE
ECONOMY**

TRUCKS

F500

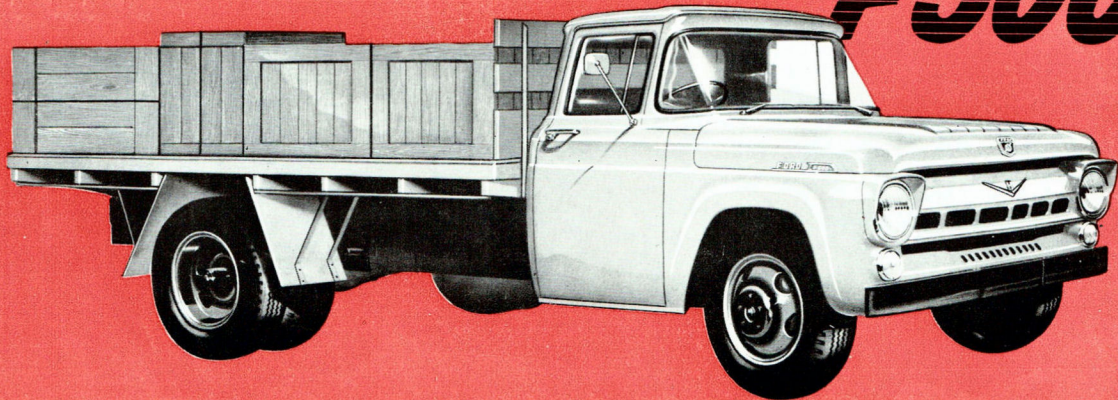

GROSS VEHICLE WEIGHT : 14,500 lbs. WHEELBASES : 130 ins., 154 ins.

Go-ahead power with Ford's short stroke OHV V8 engine!

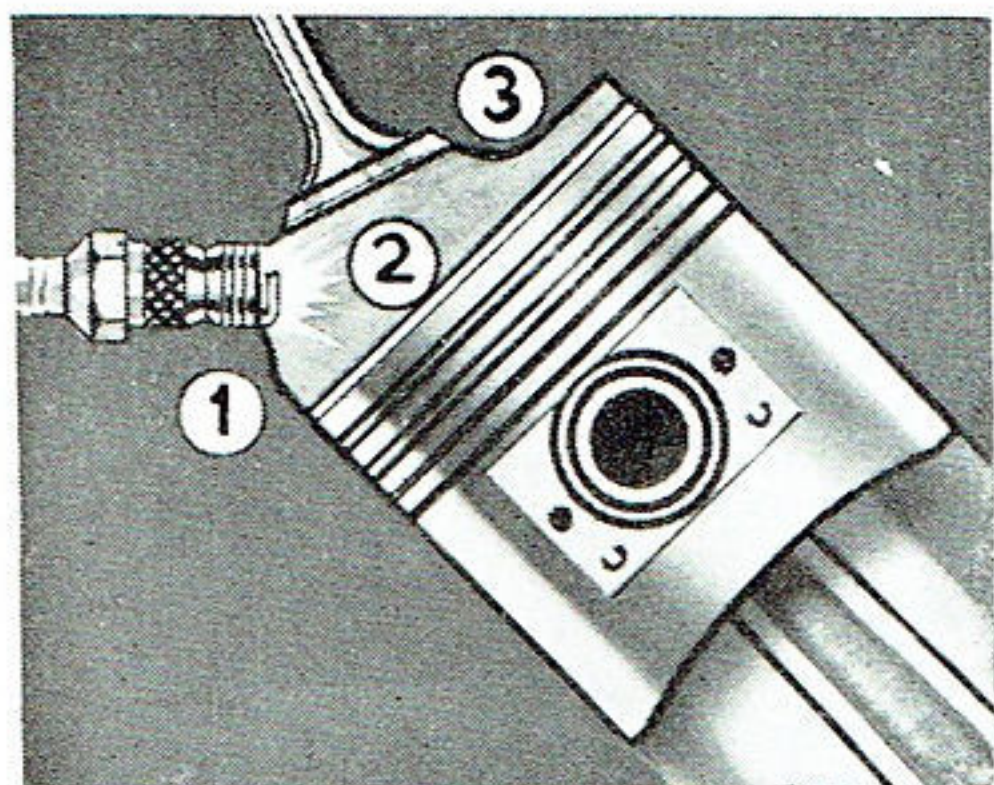

1. 12-VOLT IGNITION system gives more positive and quicker cold weather starts, greater reserve capacity to handle lights and heavier electrical loads now in today's trucks.

2. 7.1:1 COMPRESSION RATIO for extra power from fuel puts more miles in every gallon of petrol.

3. EASY BREATHING with larger intake passage and new, improved high-turbulence combustion chambers provide full power at high speeds, added pep and performance through the full range of speeds.

More Torque — more instantly useable power at all operating speeds.

This is the most powerful and efficient V8 truck engine Ford has ever built. And Ford has built more V8 engines than all other makers combined. It develops more horsepower per cubic inch displacement, far higher, more sustained torque for tough work, long hauls, and easier cruising under all bad load conditions, and big power reserves to handle pay loads more easily and economically.

Other reasons why Ford's O.H.V. V8 engine gives you more power per pound are . . . 7.1:1 compression ratio suitable for both high and low octane fuels . . . 12-volt electrical system . . . short stroke piston design, iron-alloy camshaft . . . exceptionally rigid crankshaft . . . and many other advancements.

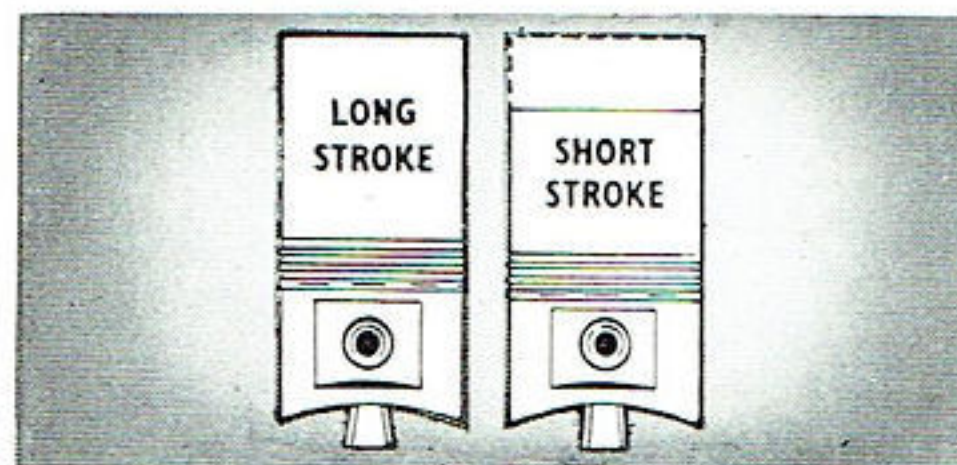
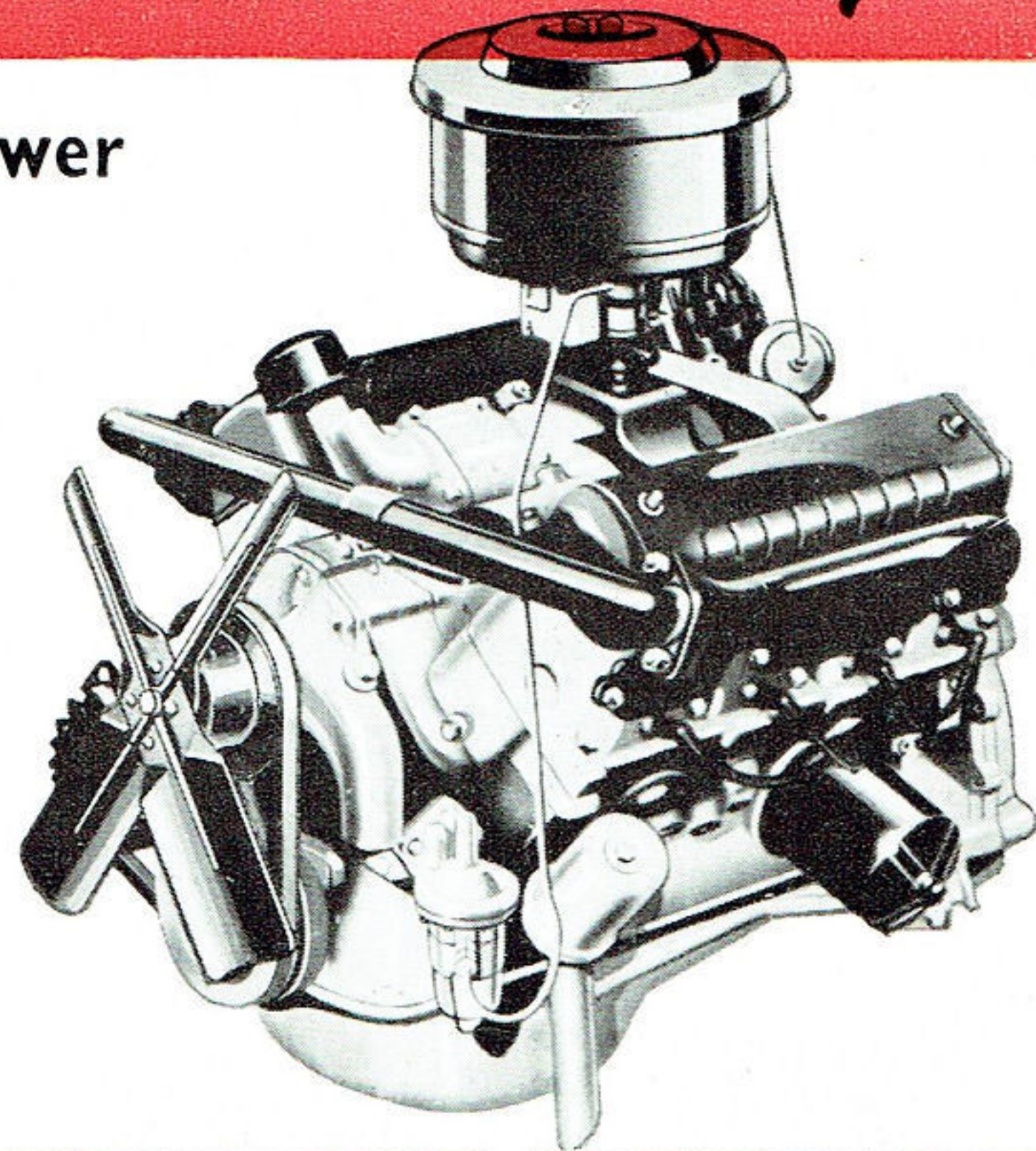

Short - stroke Low Friction Design Piston travel is less than bore diameter, this results in shorter piston travel with less friction, less wear on moving parts, longer engine life.

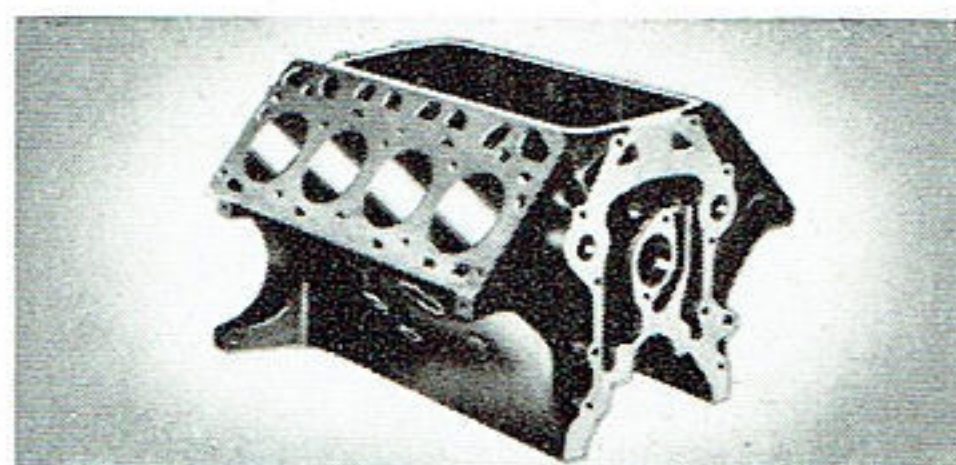

Deep Y-Block with its great rigidity means longer life, and smoother operation. The Block structure widens out at rear for very rigid connection of the block and flywheel housing.

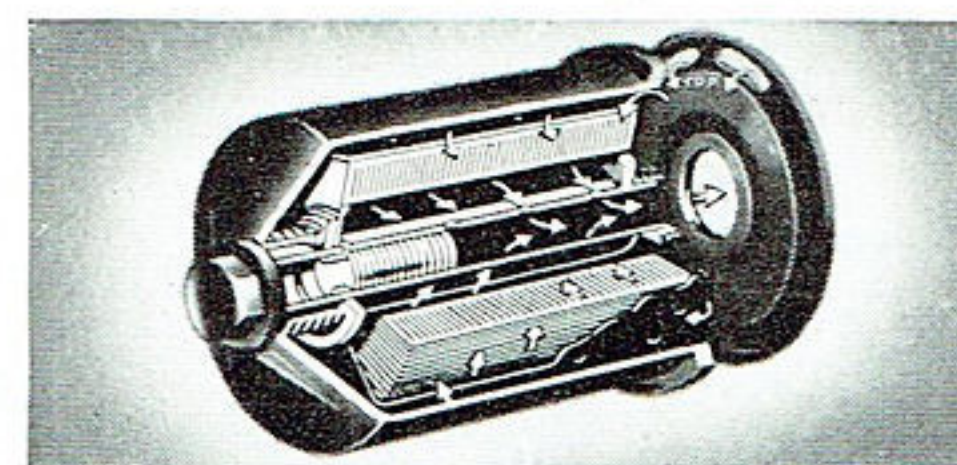

Full Flow Oil Filter cleans ALL the engine oil before it reaches bearing surfaces, reducing cylinder wall and piston ring wear and thereby contributing to longer bearing life.

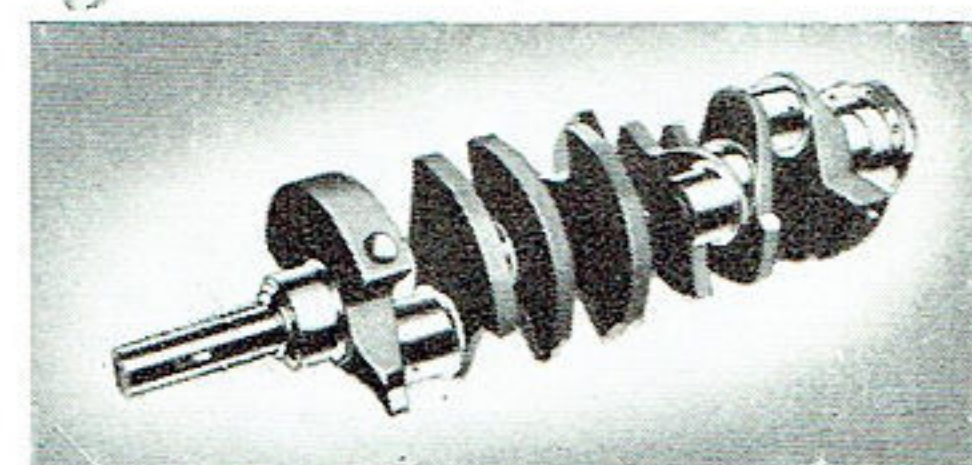

Exceptionally Rigid Crankshaft cast by an exclusive Ford method from a special iron-alloy, has 5 main bearings and eight integral counterweights for smoother operation and longer engine life.

Go-ahead styling and comfort

New, boldly modern design with greater driver ease and comfort

Ford's new driverized cabs represent one of the most sweeping changes in cab design in trucking history. In every feature, from the sleek, lower, wider silhouette to the massive, over-1000 sq. inch windscreen, it provides the ultimate in comfort for 3 big men. New, suspended pedals are easier to operate, provide extra foot room, and eliminate floor holes through which dust and fumes enter. All controls are more conveniently placed. The seat is wider, deeply sprung and adjustable. Even positioning of driver and passengers further away from the stiffer load-carrying rear suspension means more comfort, less driver-fatigue. Yes, even more than before, Ford's cab is **the** cab for truck comfort and practical design.

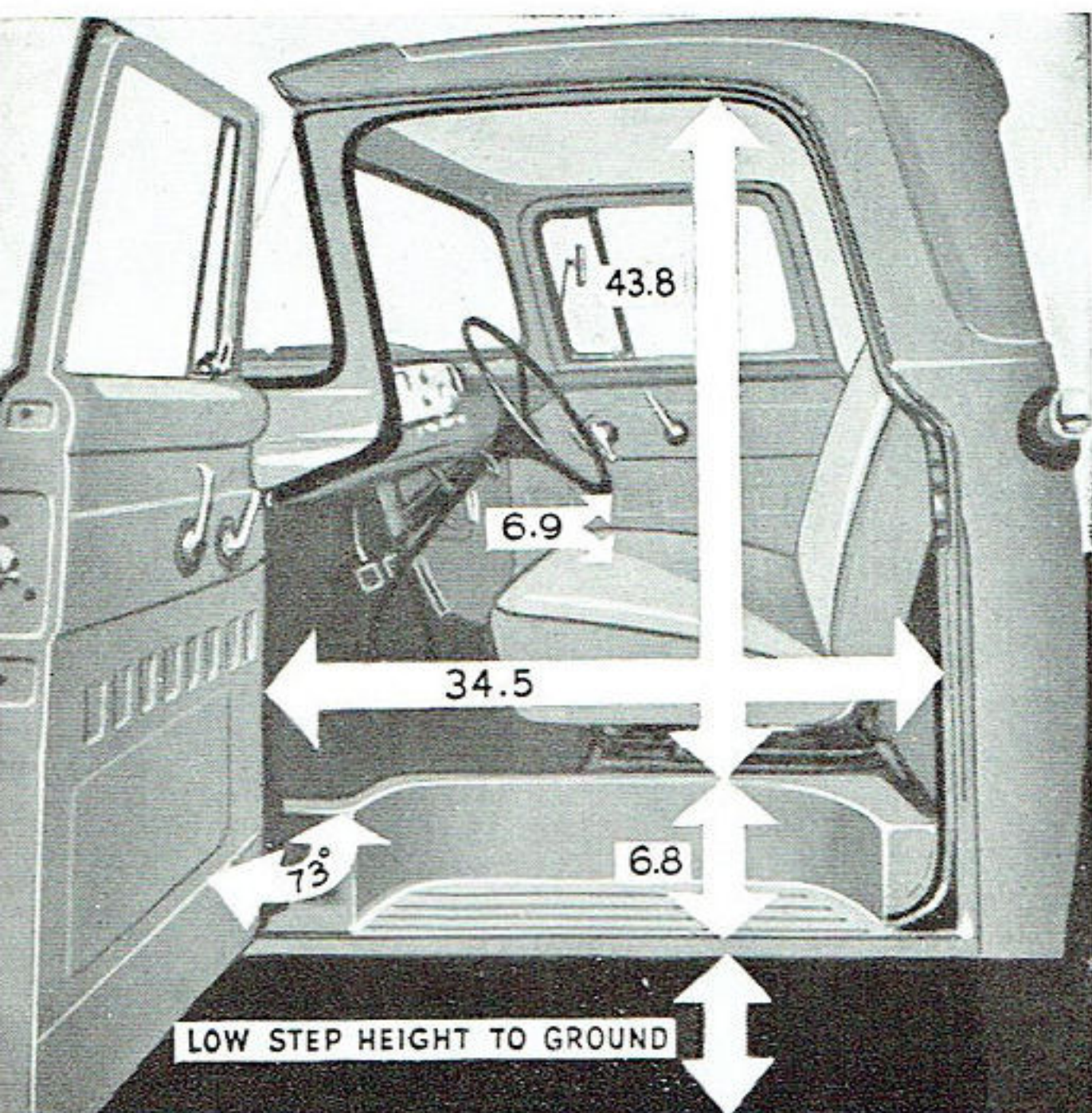

Look at the dimensions . . .

there's no squeeze in Ford's new cab—every feature is designed for roominess, comfort and for conserving the driver's energy. The doors open almost a full yard wide, the windscreen is over 1000 sq. ins. big, the new inboard step makes it easier to climb in and out of the cab and increases all-over cab strength.

Suspended pedals . . .

new, "natural position" suspended clutch, brake and accelerator pedals eliminate holes in floor for a tighter sealed cab . . . the clutch is hydraulically assisted for easier operation . . . and full clearance is maintained between pedals and steering column.



New inboard cab step

is just a short, low step from ground to cab, makes it easier to climb aboard. It provides, too, greater protection against water and slush entering the cab in inclement weather than the outboard steps. And there's ample clearance between the seat and door post to swing your feet through.

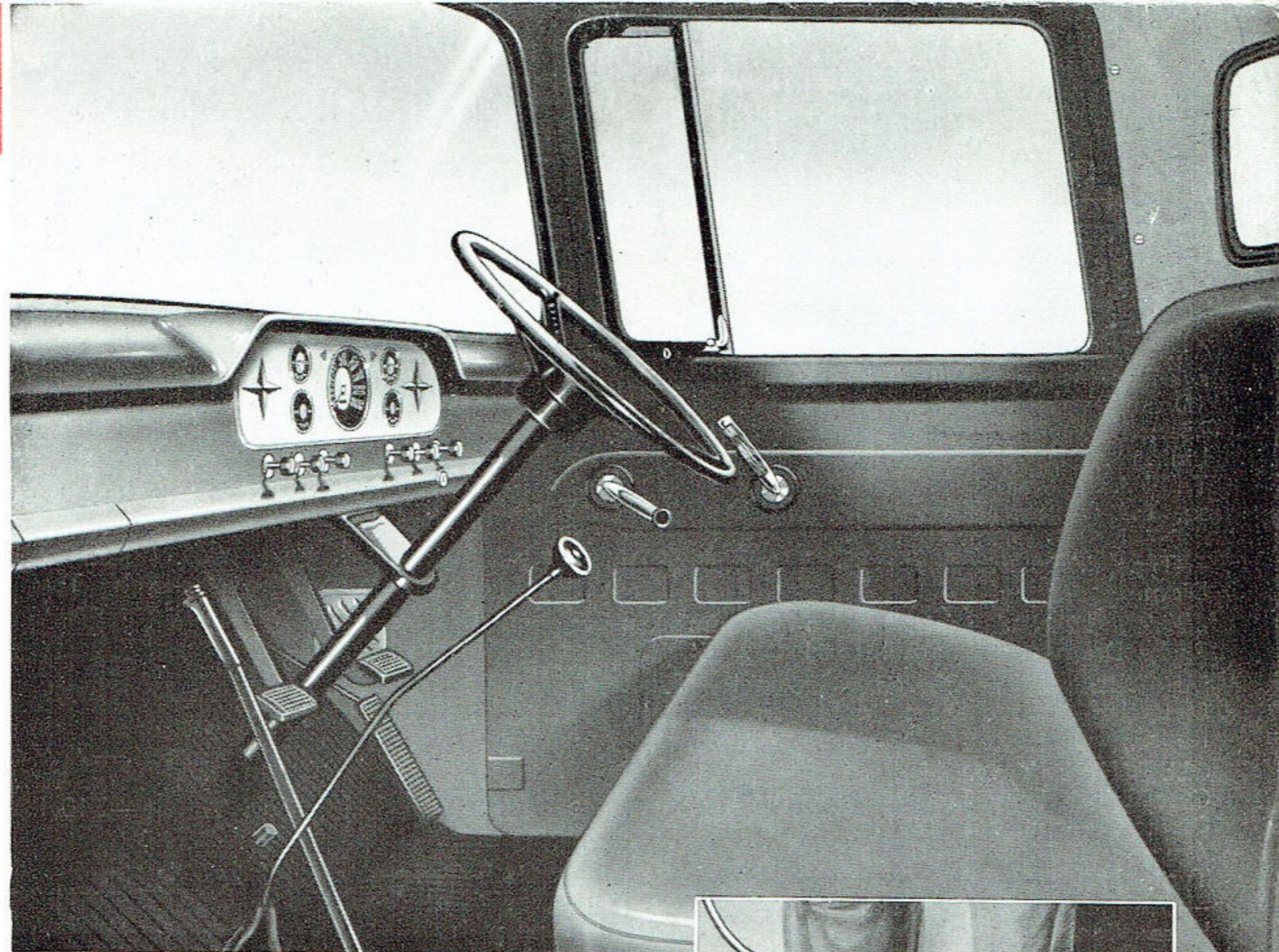
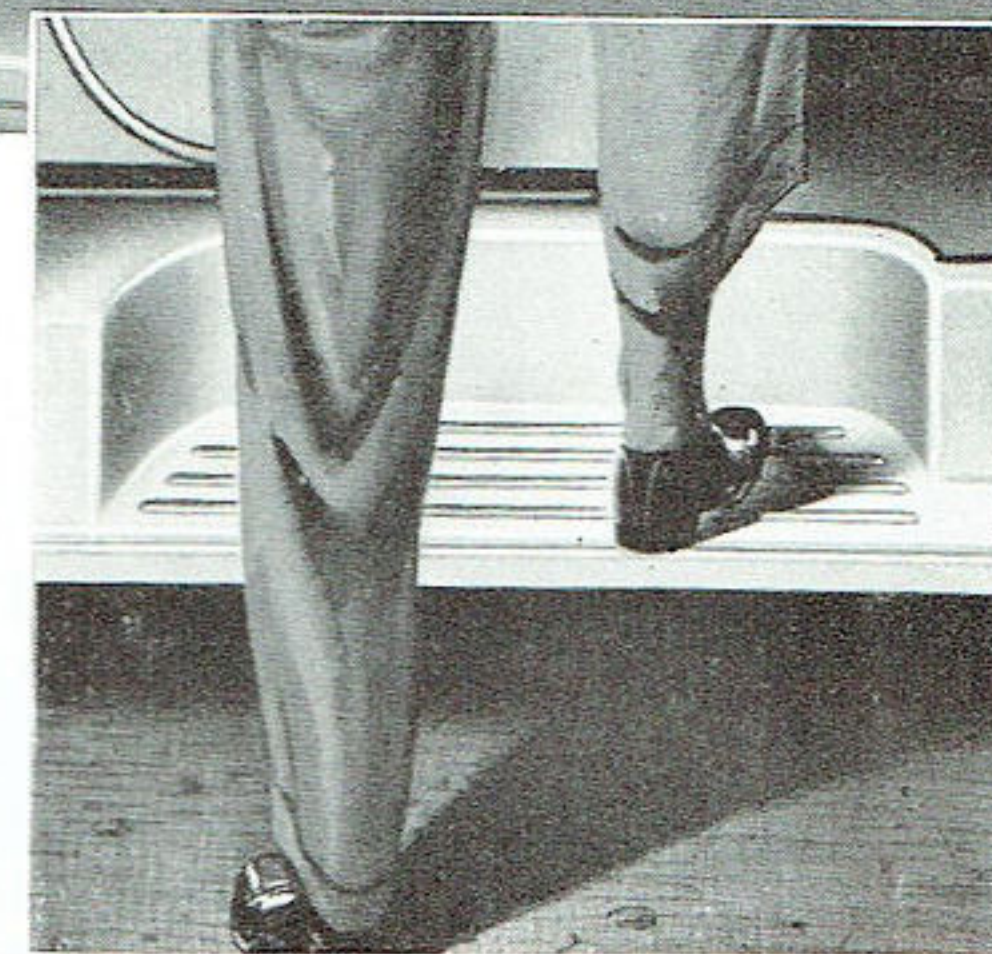

Go-ahead strength with Ford's husky chassis!

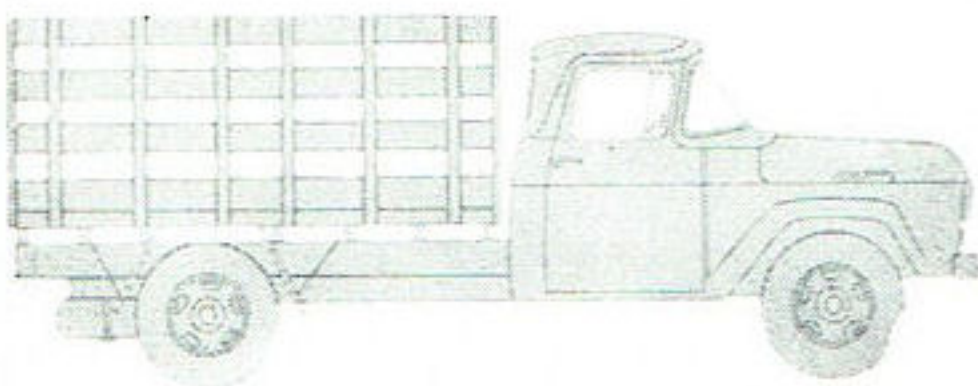

WIDE-TRACK, SET-BACK FRONT-AXLES

Front axle position allows shorter wheelbase, greater manoeuvrability. Load centre further forward and longer capacity front axle, mean better weight distribution.

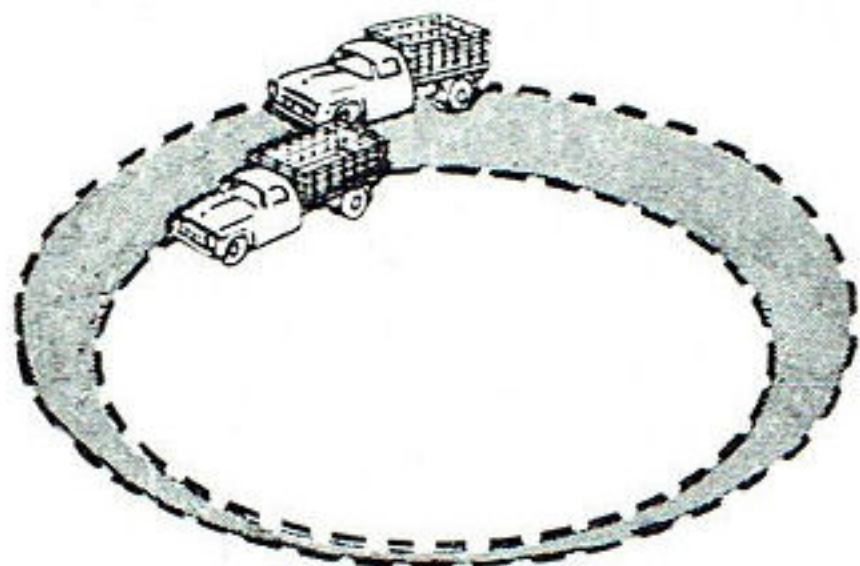

SHORTER TURNING

Wider track and shorter wheelbase design reduces turning circle diameters up to 6 ft.



CUSHIONED RIDE CONTROL

Softer ride for driver and load. With shorter wheelbase driver is closer to smooth-riding front springs and further from load-carrying stiffer rear springs.

Every feature means more work at less cost!

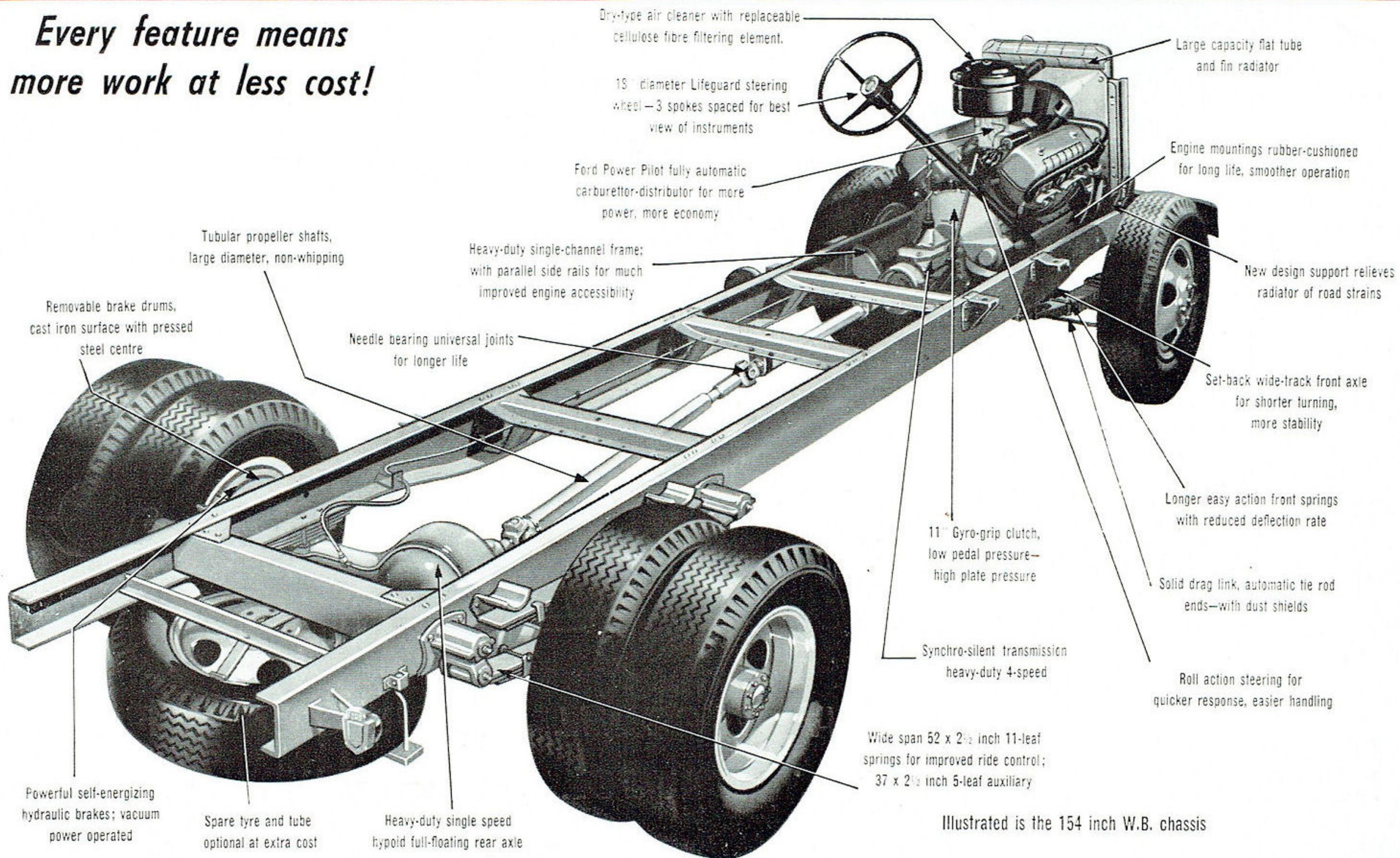

Dry-type air cleaner with replaceable cellulose fibre filtering element.

19" diameter Lifeguard steering wheel—3 spokes spaced for best view of instruments

Ford Power Pilot fully automatic carburettor-distributor for more power, more economy

Large capacity flat tube and fin radiator

Engine mountings rubber-cushioned for long life, smoother operation

New design support relieves radiator of road strains

Set-back wide-track front axle for shorter turning, more stability

Longer easy action front springs with reduced deflection rate

Solid drag link, automatic tie rod ends—with dust shields

Roll action steering for quicker response, easier handling

11" Gyro-grip clutch, low pedal pressure—high plate pressure

Synchro-silent transmission heavy-duty 4-speed

Wide span 52 x 2½ inch 11-leaf springs for improved ride control; 37 x 2½ inch 5-leaf auxiliary

Illustrated is the 154 inch W.B. chassis

Tubular propeller shafts, large diameter, non-whipping

Heavy-duty single-channel frame; with parallel side rails for much improved engine accessibility

Needle bearing universal joints for longer life

Removable brake drums, cast iron surface with pressed steel centre

Powerful self-energizing hydraulic brakes; vacuum power operated

Spare tyre and tube optional at extra cost

Heavy-duty single speed hypoid full-floating rear axle

FORD $\frac{\text{O.H.V.}}{\text{V8}}$ TRUCK DESIGN IS RIGHT FOR TODAY . . . AND FOR YEARS AHEAD !
FORD'S DESIGN IS MODERN . . . THROUGH AND THROUGH !

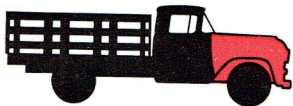

Go-ahead POWER

Always out front for power, Ford again gives you **more usable** and **cost saving** overhead valve V8 power . . . the most efficient and hardest working power in trucking today. And, with high torque development for more "thrust" at the wheels, and deep Y-block low friction design, you get longer engine life and lower maintenance costs. Ford's O.H.V. V8 truck engine is your Big Economy Item No. 1!

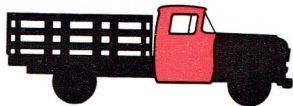

Go-ahead CAB DESIGN

Ford's big 3-man cab is the newest and most comfortable ever! And its overall appearance puts it way out in front as a prestige builder for your business. Every feature has been scientifically tested to make driving operation the easiest and simplest in trucking. Its new design lessens driver fatigue, saves him time, and increases working capacity. And that's Big Economy Item No. 2.

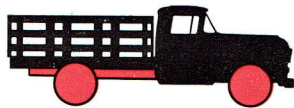

Go-ahead CHASSIS strength

Ford's ability to haul big pay loads comes from Ford's new, more rugged chassis design. Ton-mile hauling costs are cut to a minimum! You'll find the right load-carrying capacity in the Ford range to suit **exactly** your needs. And chassis design provides too for practical, low-cost installation of any standard or specialised body-type you may require. Profitable pay load capacity is Big Economy Item No. 3!

**AND YOUR PROFITS KEEP GOING AHEAD . . . FOR FORD TRUCKS COST LESS
. . . LESS TO OWN . . . LESS TO RUN . . . AND LAST LONGER TOO !**

ABRIDGED SPECIFICATIONS FORD F 500 (G.V.W. 14,500 lbs.) TRUCK

AXLE, FRONT: Type—Modified I-beam. Material—Heat-treated Alloy Steel Forging.

AXLE, REAR: Type—Single speed Full Floating. Axle Shaft Diameter as Spline—1.75 ins. Axle Ratio—5.83 to 1.

BRAKES, SERVICE: Type—Front, Single Anchor, Self-engaging; Rear, Hydraulic Two-cylinder Independently Anchored. **Front Brake** (Drum Diameter x Lining Width-Thickness)—13 x 2½-¾ ins. **Rear Brake** (Drum Diameter x Lining Width-Thickness)—15 x 4-¾ ins. **Total Area**—Drum, 560.78 sq. in. Lining, 366 sq. ins. **Drums**—Type—Demountable. **Material**—Cast Iron Fused to Steel Back. **Booster**—Type, Vacuum-assisted 8.12 in. effective Diam.

BRAKE, HAND: Operating on Transmission Brake Drum and External Band.

BUMPER: Type—Curved Channel Type. **Mounting**—Bolted Direct to Front Frame Side Rails.

CLUTCH: Type—Hydraulically operated Gyro-Grip, Semi-Centrifugal Single Plate. **Diameter**—Outside, 11 in. **Total Frictional Area**—123.7 sq. in. **Cover Plate**—Ventilated Type. **Pressure Plate**—Cast Iron. **Clutch Disc**—Cushioned Hub with Vibration Damper. **Release Bearing**—Sealed Ball, Pre-lubricated.

Pilot Bearing—Oil-impregnated Bronze. **Attachment**—Levers to Pressure Plate, Needle Roller Bearings.

COOLING SYSTEM: Capacity—21.6 qts. **Radiator**—Flat Tube and Fin—Pressure Cap. **Thermostats**—In Engine Water Outlet. **Fan**—Diameter, 18 in. Blades, 4.

DRIVE LINE: Type—Hotchkiss, Straight-line Drive. **Universal Joints**—Number Three Type. Needle Roller Bearing.

ELECTRICAL SYSTEM: **Battery**—Heavy Duty, 12-volt. **Generator**—30 Amp. **Ignition**—Full Vacuum Controlled System; Fully Automatic Distributor; Metal-Clad Coil; Open Wiring in Rubber Grommets. **Headlights**—Sealed Beam, Foot-switch control. **Starter**—High Torque, Automatic Engagement, Solenoid Switch, Ignition Switch Control. **Parking Lights**—Combination Stop and Tail Lights; Instrument Lights; Ignition Switch with Key Lock.

ENGINE: No. Cylinders—Bore and Stroke—8—3.62 x 3.30 ins. **Displacement**—272 cu. in. **Compression Ratio**—7.1 : 1. **Max. B.H.P.** 166 at 4,400 r.p.m. **Max. Torque**—240 lbs./ft. at 2,200-2,600 r.p.m.

FRAME: Type—Heavy Duty Sidarail—Parallel Channel Section. **Crossmembers**—Flanged "U" Type with Alligator Jaw and Channel Section.

FUEL SYSTEM: **Carburettor**—Dual Down-draught. **Air Cleaner**—Dry Type, Cellulose Fibre Element. **Fuel Pump and Filter**—Diaphragm Type, Driven from Camshaft. **Fuel Tank**—Chassis with Cab, 14.5 gal. inside Cab. **Fuel Filler**—Tube Extension to outside Cab.

LUBRICATION: **Engine**—Full Pressure Feed to all Main Crankpin and Camshaft Bearings. **Crankcase Capacity**—8pts., plus 1 pt. for dry filter. **Chassis**—Fittings for Pressure Lubrication.

SPRINGS: Semi-elliptic, Alloy Steel Front and Rear. **Length and Width**—Front, 45 x 2 in. Rear, 52 x 2½ in. Main Auxiliary, 37 x 2½ in.

STEERING: Type—Worm and Single Row, Needle Bearing Roller. **Ratio**—20.4 to 1. **Wheel**—18 in. Diam., 3-spoke. **Turning Radius**—154 in. W.B., R.H. 27.25 ft. L.H. 27.8 ft. 172 in. W.B., R.H. 29.75 ft. L.H. 30.35 ft. **Tie Rod**—Ball Stud and Socket, Spring loaded for Automatic Take-up of Wear, equipped with Rubber Dust Shields.

TRANSMISSION: Type—4-Speed Synchro-Silent; Floor Change. **Gear Positions**—Ratio (to 1), First 6.40; Second 3.09; Third 1.69; High 1.00, Reverse 7.82. **Lubricant Capacity**—6.6 Pints.

WHEELS AND TYRES: **Wheels**—7—6.0 x 20 Steel Disc with 8 inch Diameter Bolt Circle. **Tyres**—6—7.50 x 20, 8-ply (10-ply opt. at extra cost).

CHASSIS EQUIPMENT included as standard, in addition to items specified above: Hood, Cowl and Dash Assembly; Front Fenders; Fully Controlled Ventilation System; Steel Toeboards; Instrument Panel; Speedometer; Water Temperature Gauge; Oil Pressure Warning Light; Fuel Gauge; Charge Indicator Warning Light; Ash Receptacle; Glove Box; Choke Button; Light Switch; Hand Throttle; Windshield Wipers; Electric Horn; Spare Tyre Carrier; Air Wing Ventilating Windows in Doors; Mirror, Rear View—outside on Cab.

Ford Motor Company of Australia Pty. Ltd. whose policy is one of continuous improvement, reserves the right, subject to such regulations as may from time to time apply, to change specifications and prices at any time without notice or incurring liability to purchasers.

FORD MOTOR COMPANY OF AUSTRALIA PTY. LTD.

(Incorporated in Victoria) Registered Office: Geelong, Victoria

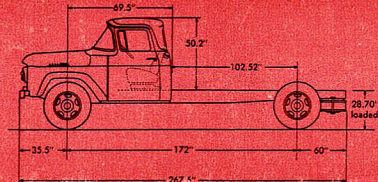
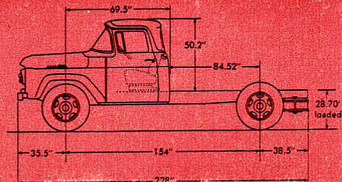

Go-ahead power with Ford's short stroke OHV V8 engine!

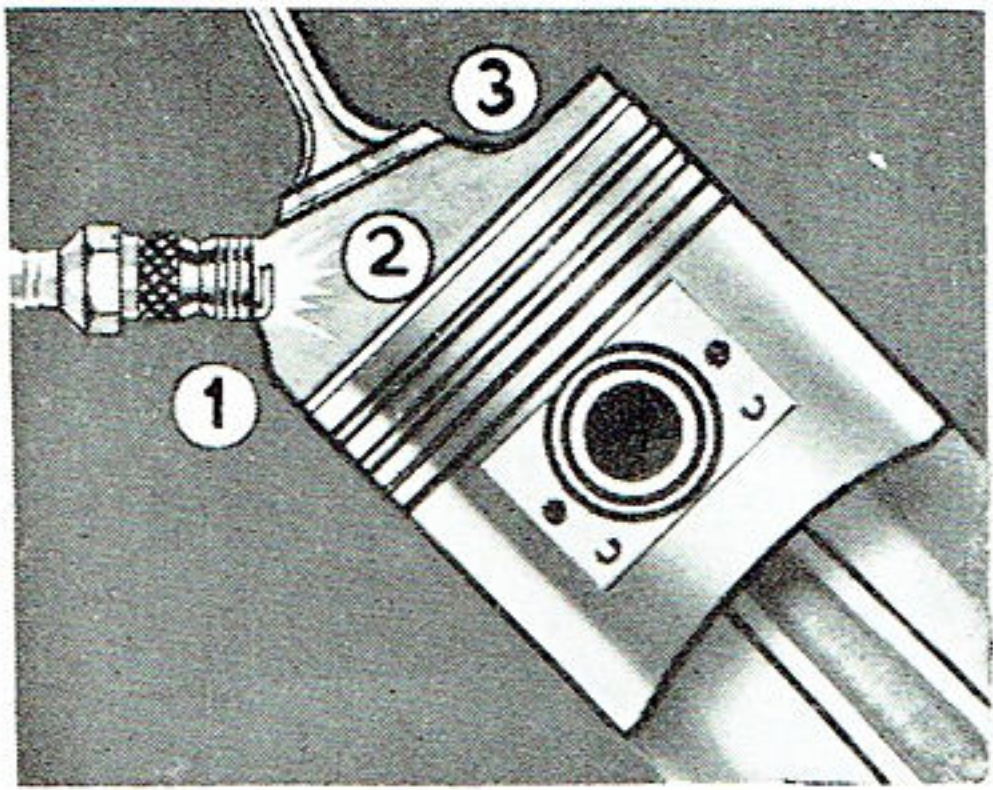

1. 12-VOLT IGNITION system gives more positive and quicker cold weather starts, greater reserve capacity to handle lights and heavier electrical loads now in today's trucks.

2. 7.1:1 COMPRESSION RATIO for extra power from fuel puts more miles in every gallon of petrol.

3. EASY BREATHING with larger intake passage and new, improved high-turbulence combustion chambers provide full power at high speeds, added pep and performance through the full range of speeds.

More Torque — more instantly useable power at all operating speeds.

This is the most powerful and efficient V8 truck engine Ford has ever built. And Ford has built more V8 engines than all other makers combined. It develops more horsepower per cubic inch displacement, far higher, more sustained torque for tough work, long hauls, and easier cruising under all bad load conditions, and big power reserves to handle pay loads more easily and economically.

Other reasons why Ford's O.H.V. V8 engine gives you more power per pound are . . . 7.1:1 compression ratio suitable for both high and low octane fuels . . . 12-volt electrical system . . . short stroke piston design, iron-alloy camshaft . . . exceptionally rigid crankshaft . . . and many other advancements.

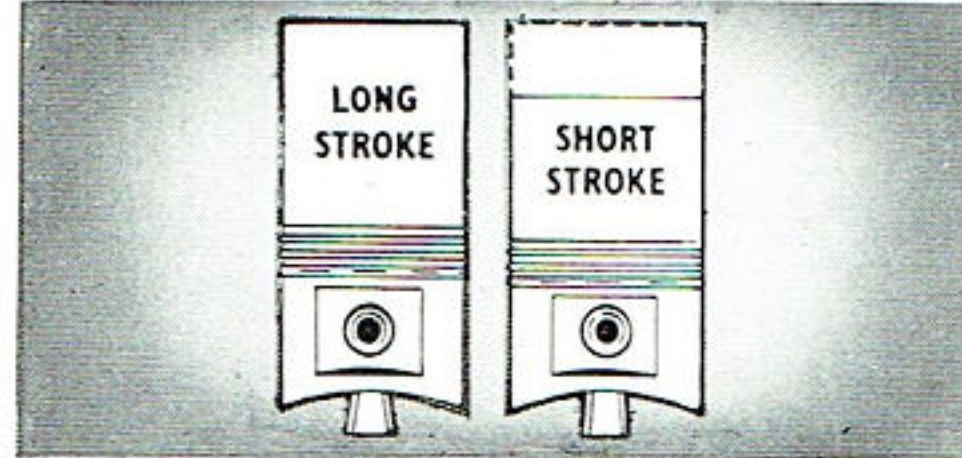
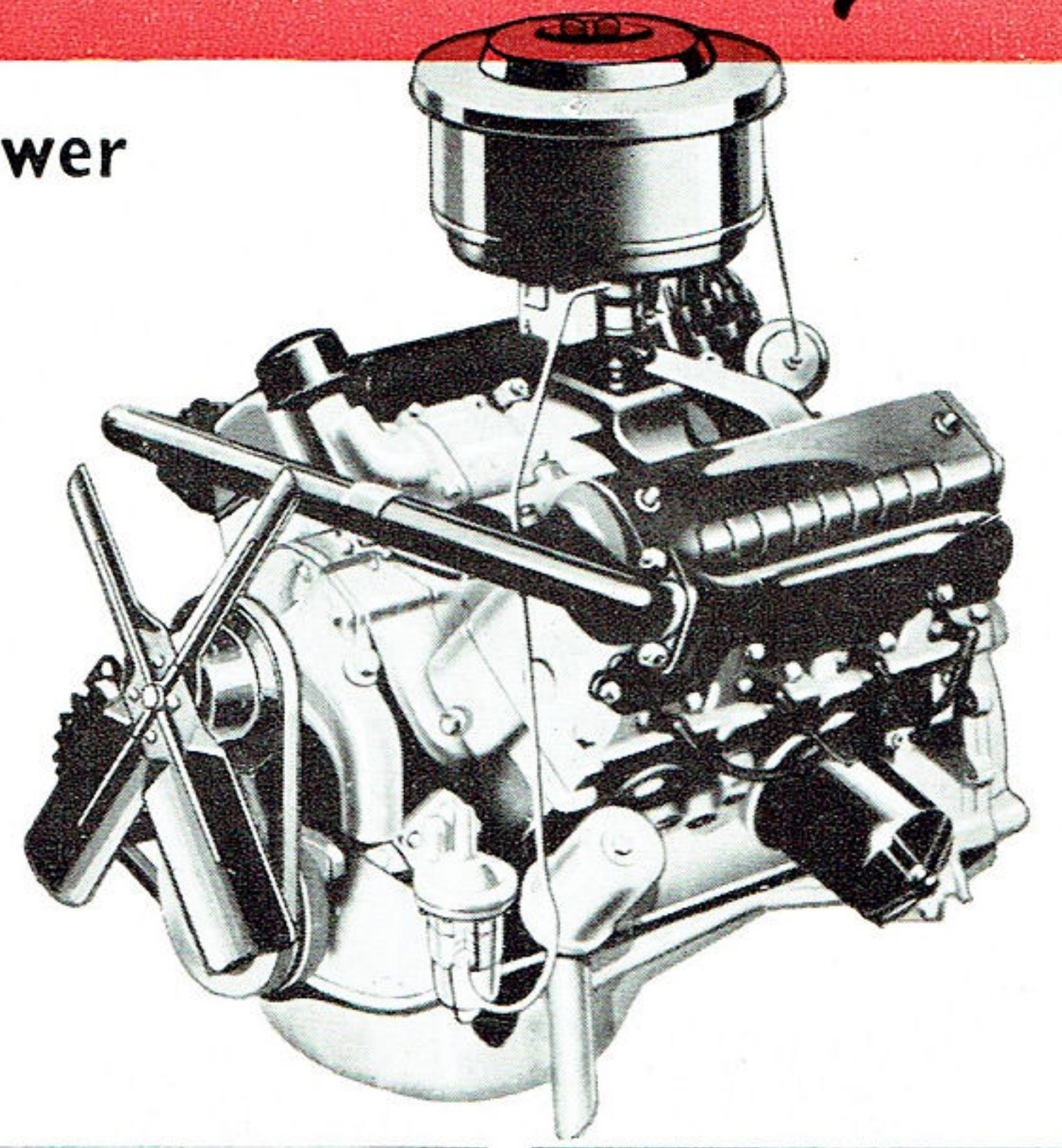

Short - stroke Low Friction Design Piston travel is less than bore diameter, this results in shorter piston travel with less friction, less wear on moving parts, longer engine life.

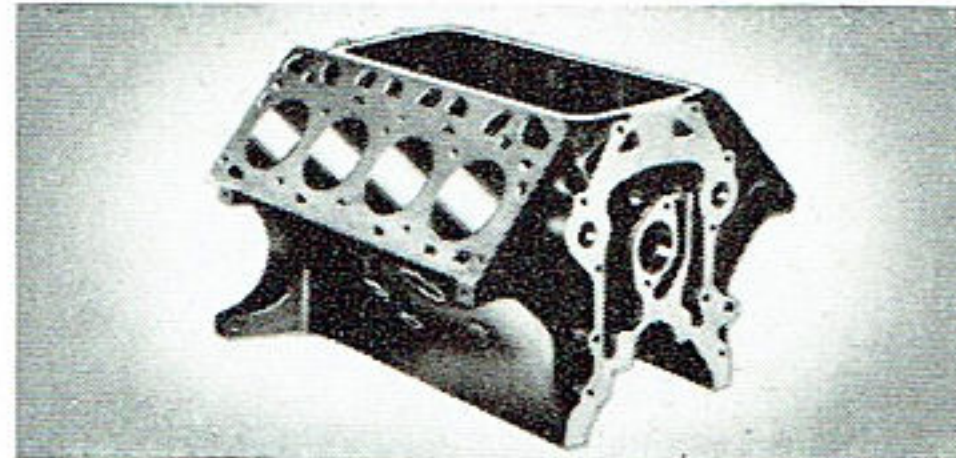

Deep Y-Block with its great rigidity means longer life, and smoother operation. The Block structure widens out at rear for very rigid connection of the block and flywheel housing.

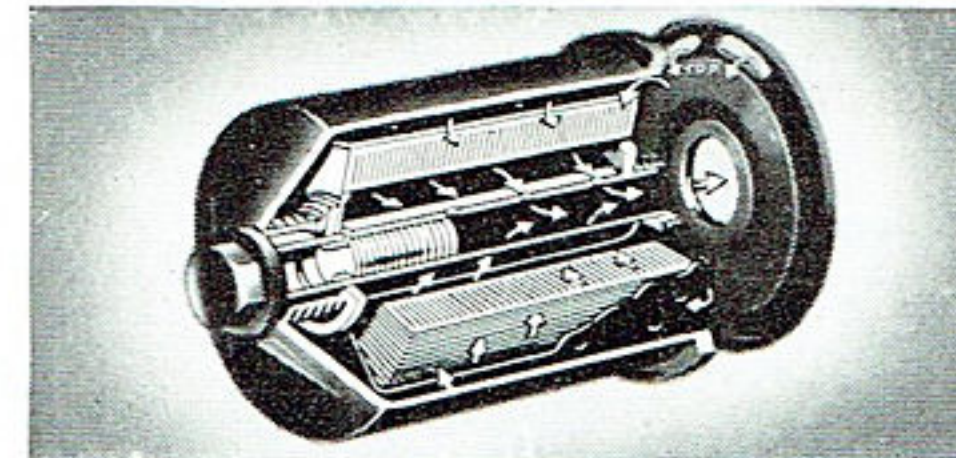

Full Flow Oil Filter cleans ALL the engine oil before it reaches bearing surfaces, reducing cylinder wall and piston ring wear and thereby contributing to longer bearing life.

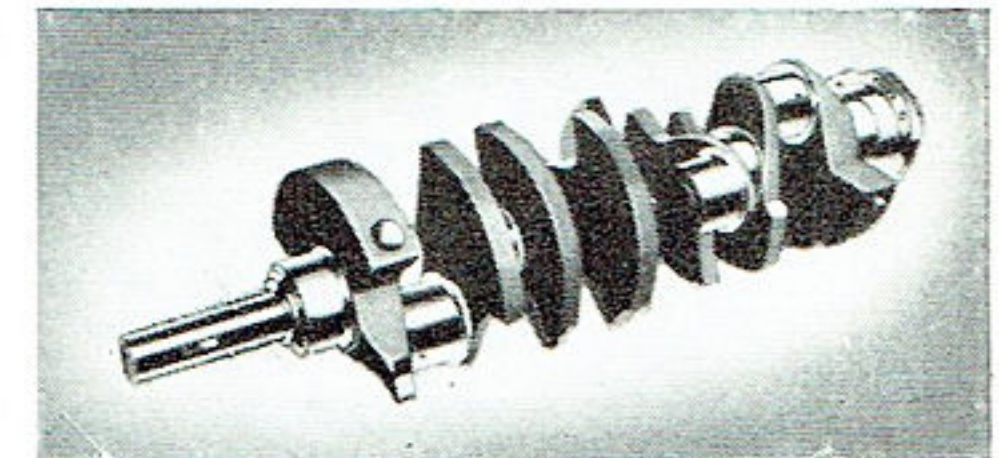

Exceptionally Rigid Crankshaft cast by an exclusive Ford method from a special iron-alloy, has 5 main bearings and eight integral counterweights for smoother operation and longer engine life.

Go-ahead styling and comfort

New, boldly modern design with greater driver ease and comfort

Ford's new driverized cabs represent one of the most sweeping changes in cab design in trucking history. In every feature, from the sleek, lower, wider silhouette to the massive, over-1000 sq. inch windscreen, it provides the ultimate in comfort for 3 big men. New, suspended pedals are easier to operate, provide extra foot room, and eliminate floor holes through which dust and fumes enter. All controls are more conveniently placed. The seat is wider, deeply sprung and adjustable. Even positioning of driver and passengers further away from the stiffer load-carrying rear suspension means more comfort, less driver-fatigue. Yes, even more than before, Ford's cab is **the** cab for truck comfort and practical design.

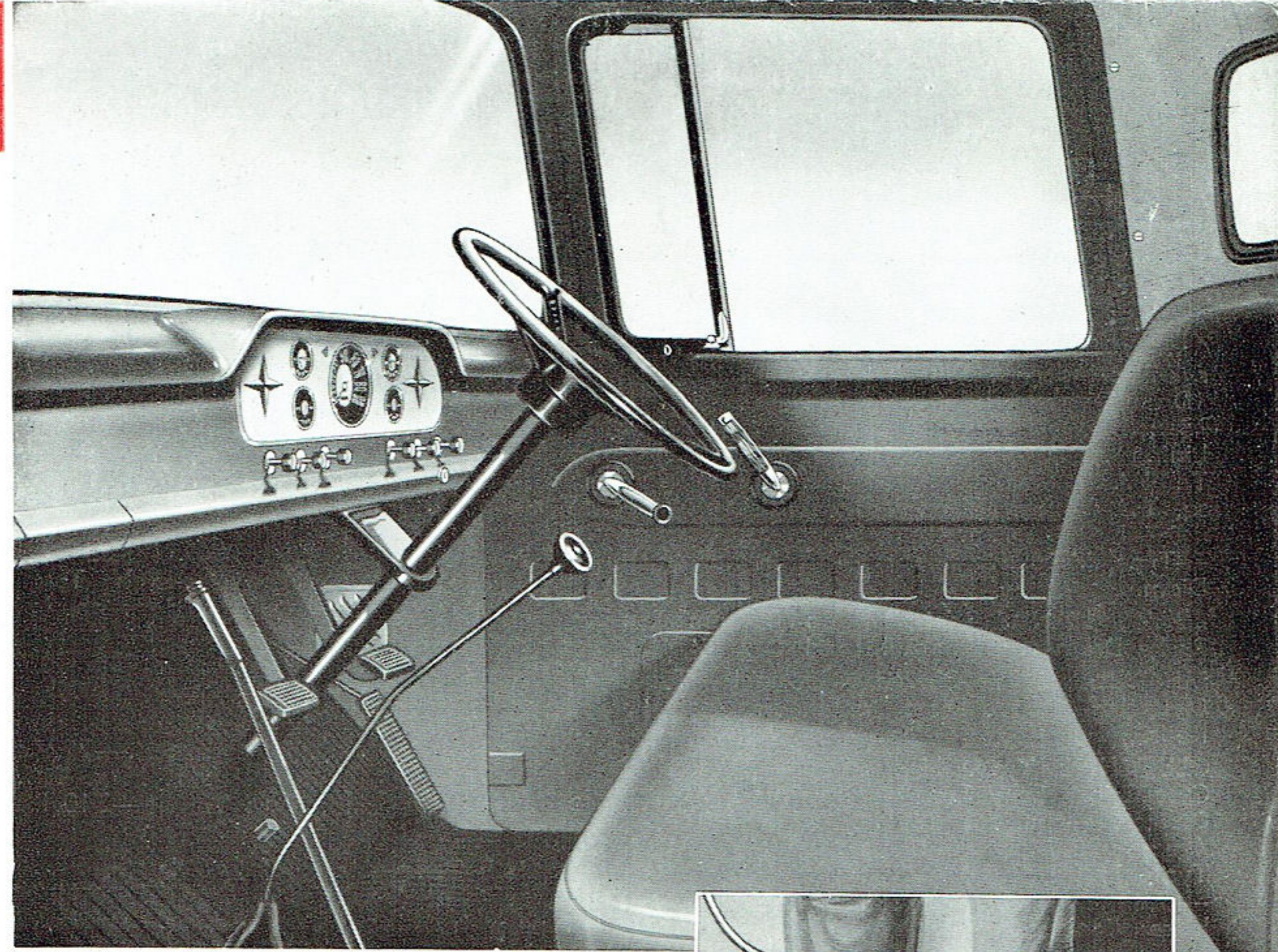

Look at the dimensions . . .

there's no squeeze in Ford's new cab—every feature is designed for roominess, comfort and for conserving the driver's energy. The doors open almost a full yard wide, the windscreen is over 1000 sq. ins. big, the new inboard step makes it easier to climb in and out of the cab and increases all-over cab strength.

Suspended pedals . . .

new, "natural position" suspended clutch, brake and accelerator pedals eliminate holes in floor for a tighter sealed cab . . . the clutch is hydraulically assisted for easier operation . . . and full clearance is maintained between pedals and steering column.



New inboard cab step

is just a short, low step from ground to cab, makes it easier to climb aboard. It provides, too, greater protection against water and slush entering the cab in inclement weather than the outboard steps. And there's ample clearance between the seat and door post to swing your feet through.

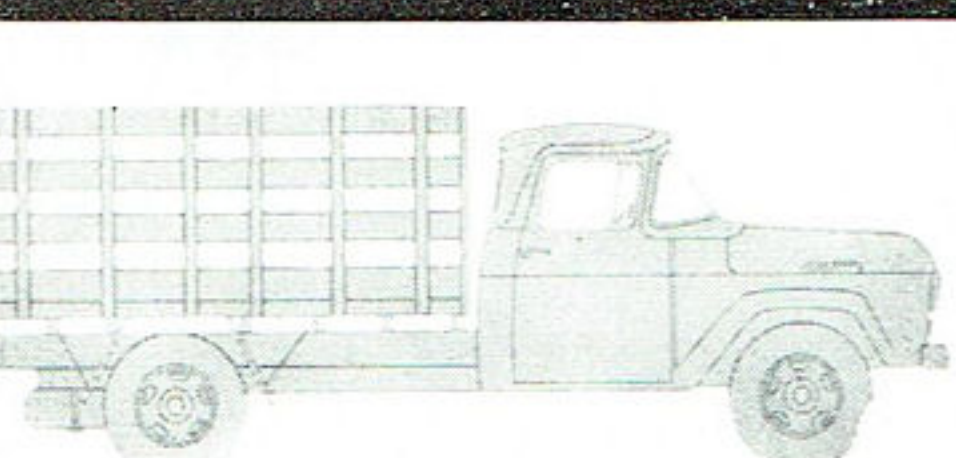
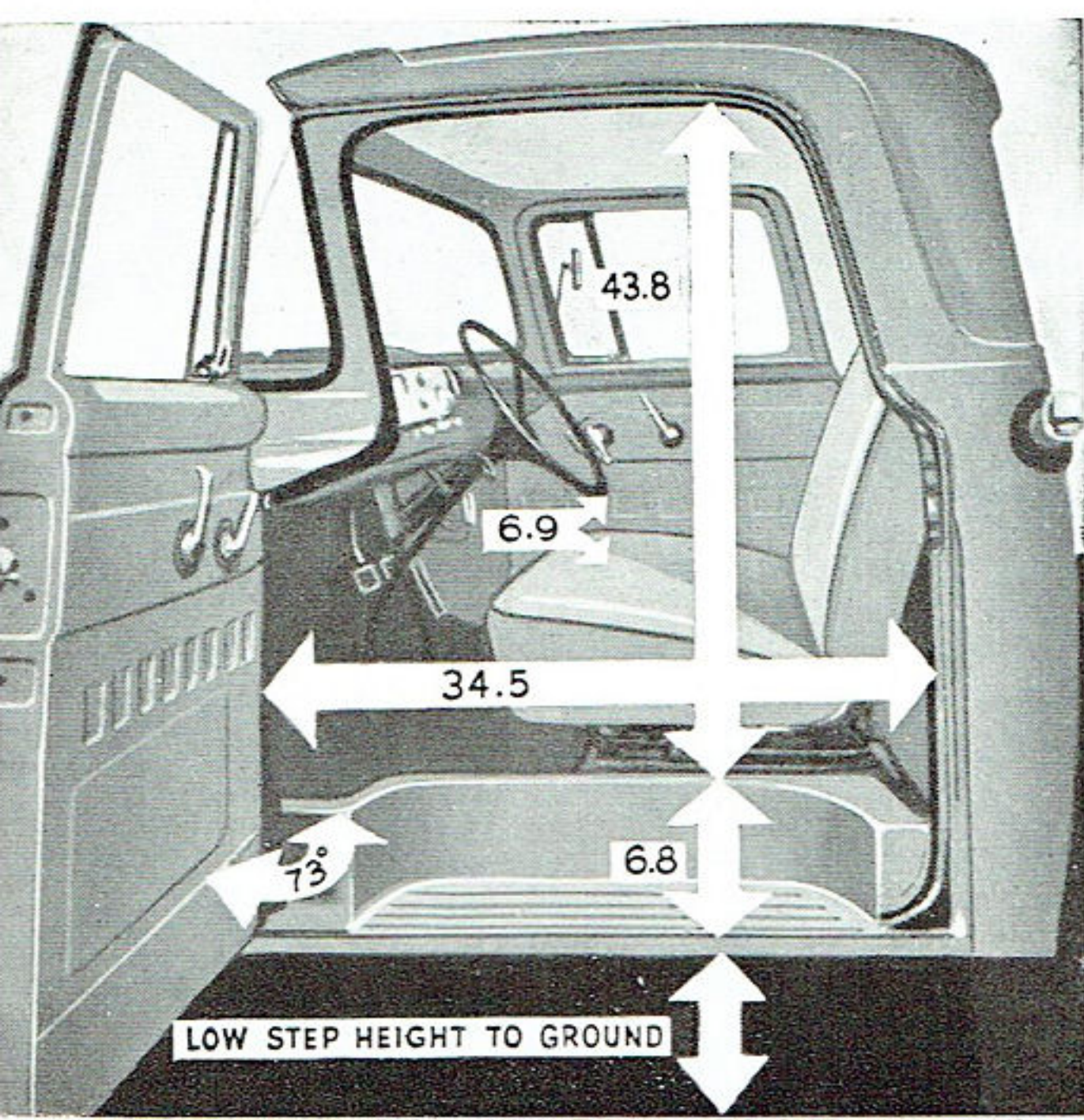
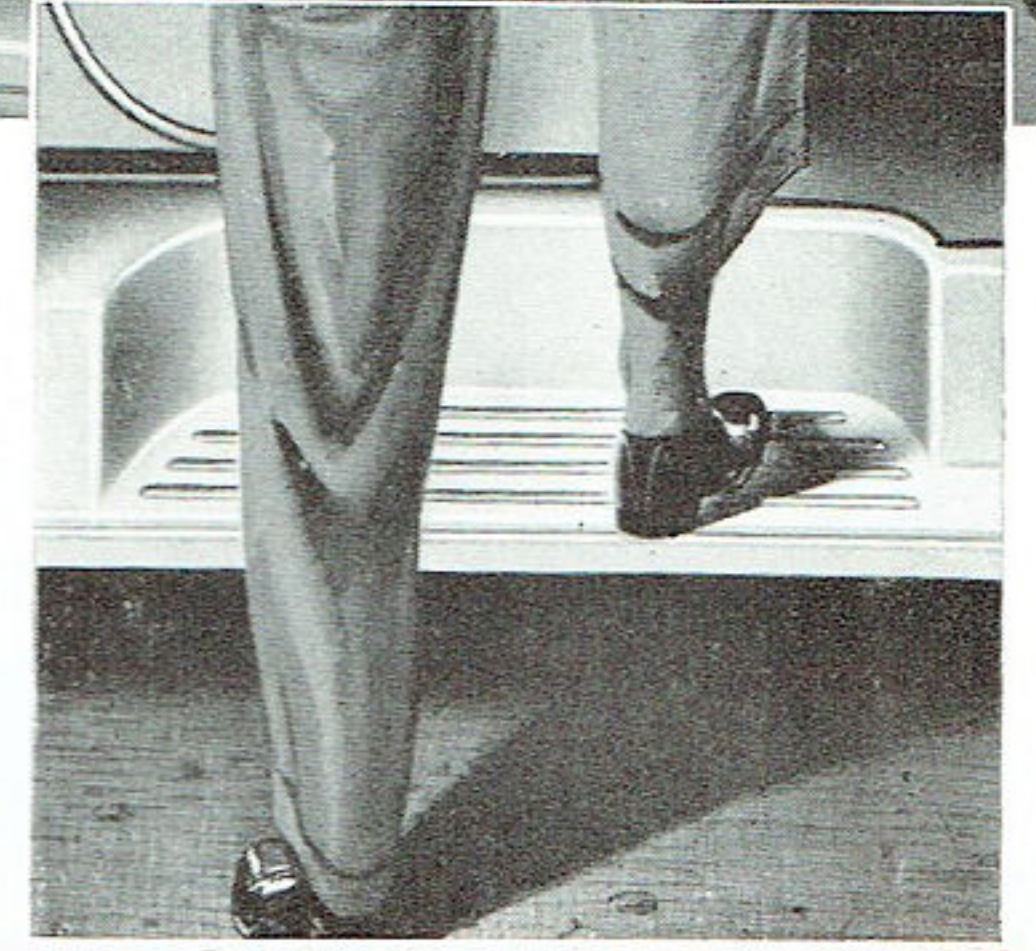

WIDE-TRACK, SET-BACK FRONT-AXLES

Front axle position allows shorter wheelbase, greater manoeuvrability. Load centre further forward and longer capacity front axle, mean better weight distribution.

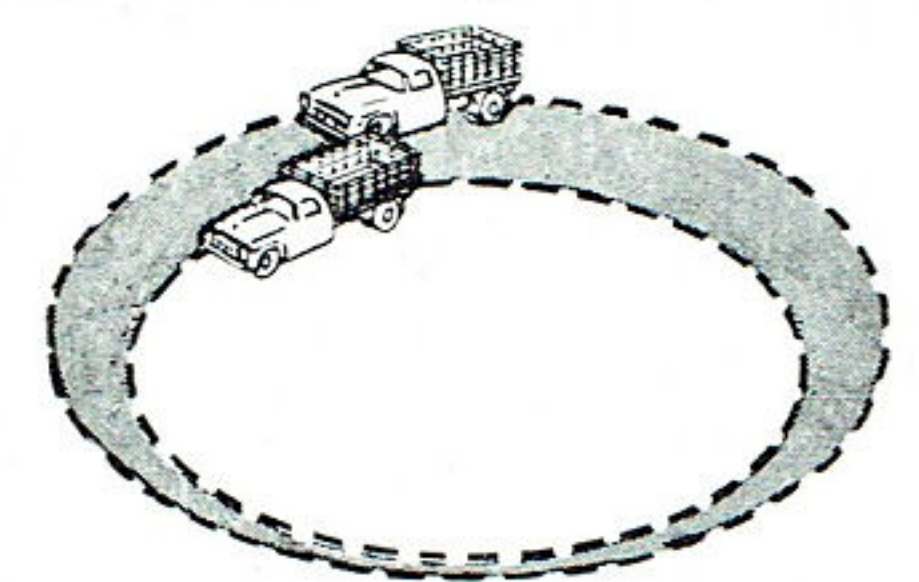

SHORTER TURNING

Wider track and shorter wheelbase design reduces turning circle diameters up to 6 ft.



CUSHIONED RIDE CONTROL

Softer ride for driver and load. With shorter wheelbase driver is closer to smooth-riding front springs and further from load-carrying stiffer rear springs.

Go-ahead strength with Ford's husky chassis!

Every feature means more work at less cost!

