

NEW FORD

MONEY-MAKERS

F 600

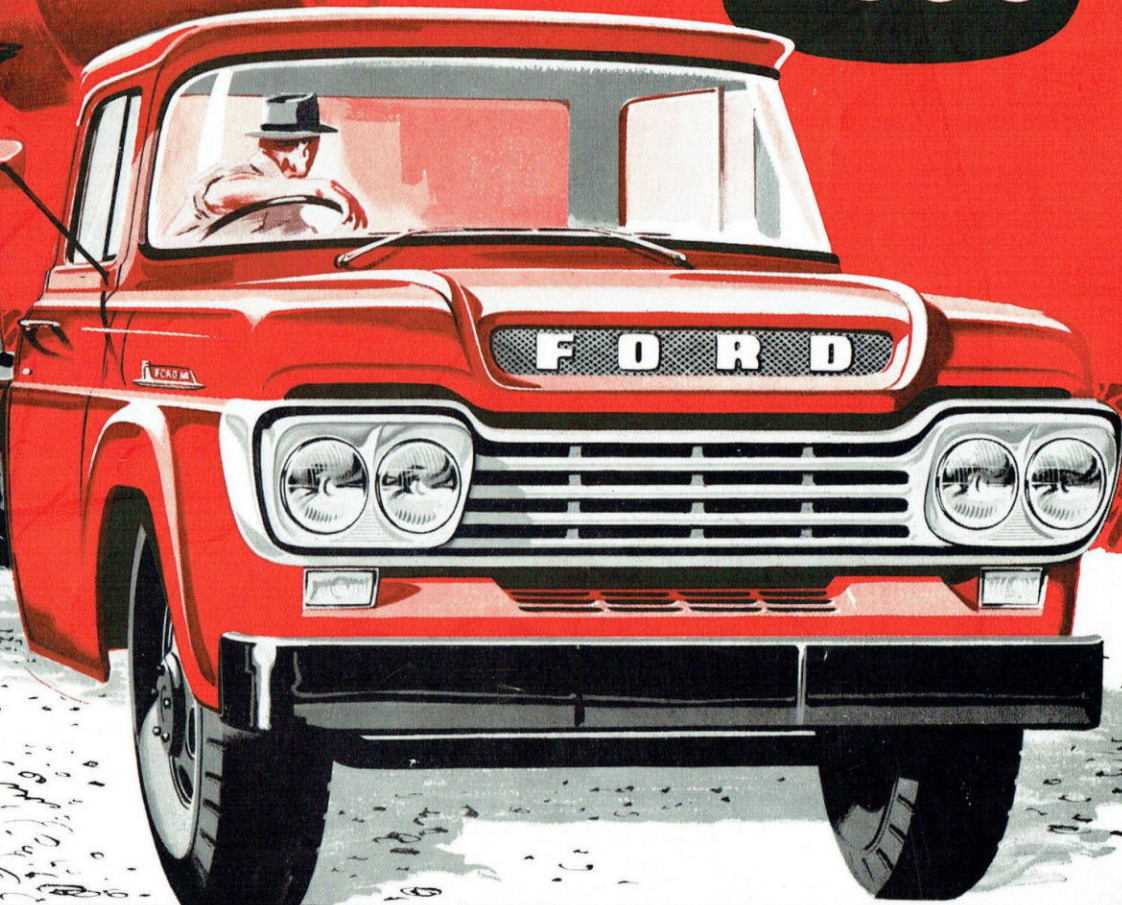

FORD O.H.V. V8 TRUCKS

Money-saving O.H.V. V8 power

Ford's O.H.V. V8 engine gives you the fullest benefit of modern Short Stroke design. Thanks to Ford's Short Stroke design, pistons travel shorter distances, at slower speeds — resulting in less wear, less power-wasting friction, and more usable power is delivered to the wheels to do your

job. In addition, moving parts last longer to keep operating costs lower! And Deep-Block construction gives greater rigidity for long life and dependable performance. This is the most efficient V8 truck engine Ford has ever built, and Ford has built more V8 engines than any other manufacturer.

Precision-moulded rocker arms for greatest durability.

Free-turn valves (both intake and exhaust) for self-cleaning, better seating, longer life.

High-turbulence combustion chambers with higher compression for greater power output.

Full-floating piston pins for longer life.

Aluminium alloy autothermic pistons with steel struts for best performance.

Full-length water jackets reduce wear. Higher capacity water pump increases cooling at low speeds.

Long-lived, copper-lead main and connecting rod bearings.

Deep engine block for greater structural rigidity, smoother engine performance.

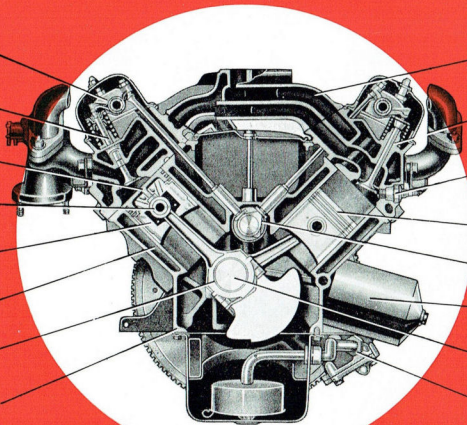

Larger short-reach intake manifold for quick, uniform fuel charge, easy starting.

Integral valve guides enable valves to run cooler, last 50% longer.

18-mm. "Turbo-Action" spark plugs — A Ford First, resist fouling with light loads, prolong peak power at full load.

Chrome-plated top ring prevents scuffing during break-in.

High-lift camshaft for wide valve opening.

Full-flow filter cleans all the oil, lengthens engine life.

Full-pressure lubrication of all crankshaft and connecting rod bearings for longer life.

High-capacity oil pump for positive lubrication, long life.

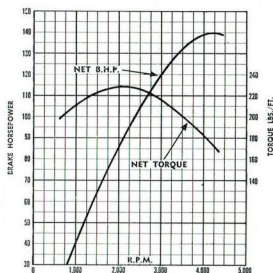

...plus the highest torque and b.h.p. in the 5-ton field!

Here is far more horsepower per cubic inch displacement, and higher, more sustained torque for tough work, long hauls, and easier cruising speeds under heavy load conditions. Net maximum b.h.p. is 139 @ 4,200 r.p.m., and the high net torque of 227 ft. lbs. is attained at the low revolutionary rate of 2,200 r.p.m. Other reasons why Ford gives you more horsepower per pound are . . . 7:1:1 compression ratio . . . 12-volt electrical system . . . iron-alloy camshaft . . . exceptionally rigid crankshaft . . . and many other engineering advances.

Greatest cab value ever — with the most in comfort, safety, and convenience

Ford Driverized Cabs are big, comfortable, and extra strong. Features are engineered in to reduce fatigue, lessen tension, and provide the nearest ride yet to sedan-like comfort.

- 1 Full wrap-around windscreen.** Now there's 1,020 square inches in Ford's wider, full wrap-around windscreen. Vision is unobstructed forward, down and to the sides.
- 2 Look at the dimensions.** There's no squeeze in this cab . . . there's more shoulder room, leg room and added head room to make driving-comfort and passenger comfort more relaxing, less fatiguing.
- 3 Inboard step.** Ford has moved the cab step up inside the door making it easier to climb aboard. It provides extra protection against water and slush—increases all-over cab strength.
- 4 Doors open wide.** Doors open almost a full yard wide—are held open by door checks. It's the easiest cab to get into and out of on the road.
- 5 Complete weather sealing.** Doors and wing vents are completely encircled by tight fitting rubber seals . . . keeping out dust, fumes, moisture and draughts.

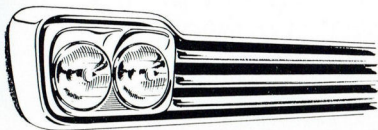
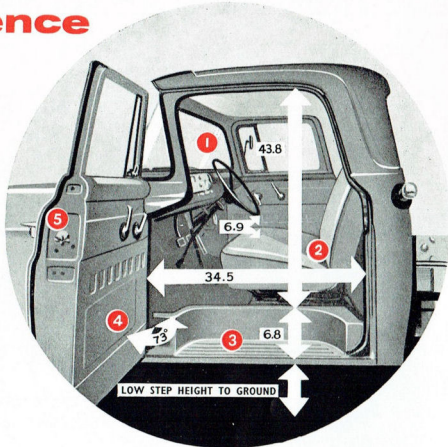

Dual headlights for safety and smartness

The dual headlight system on all Ford V8 trucks present a major improvement in lighting efficiency together with positive lighting control for added safety. Long range driving lights utilize four fixed filaments — one in each headlamp lens. The dipped beam has fixed focus spread pattern control in the outboard lights only, giving improved low-beam visibility.

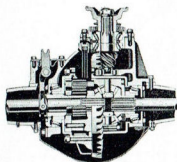

2-speed rear axle

The Eaton full floating 2-speed rear axle is a spiral bevel ring gear and pinion set providing high gear strength with quietness of operation. The pinion is straddle mounted to provide accurate alignment under high torque load.

The two-speed axles which are electrically controlled, provide, in combination with a four speed gear box 8 forward and 2 reverse drive ranges or 10 forward and 2 reverse ranges in conjunction with a five speed gear box. The 6.33:1 ratio in high is ideal for high speeds and light loads, while the 8.81:1 reduction is for maximum pull for heavy load work.

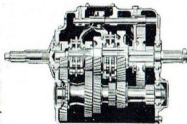

New 5-speed synchro-silent box, optional equipment

Fitting this optional synchro-silent box increases the F600's operating ease. It's 5 speeds provide a gear ratio range that means extra flexibility in heavy going.

4-speed heavy duty synchro-silent transmission

standard on the F600, provides more "pulling" ability plus more flexible and economical operation. One-piece clutch and fly wheel housing provides smoother, more reliable power plan and more strength for longer life.

Ford's rugged chassis design cuts ton mile costs!

Parallel ladder-type frame construction features heavy gauge channel side members and flanged "U" type cross members. Frames are of SAE standard 34" width to facilitate mounting of standard or custom-built bodies. Deep, wide-flanged side members extend beyond the front cross member to permit direct attachment of the front bumper which also serves as a cross member. And all cross members are strategically placed in frames to resist torsional stress.

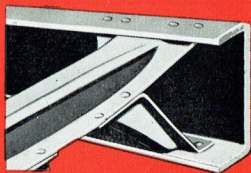

| Wheelbases | Max. Side Rail Section | Section Modulus | Number of Cross Members |
|------------|------------------------|-----------------|-------------------------|
| 154", 172" | 9.25" x 2.94" x 0.25" | 9.25" | 6 |
| 192" | 9 x 31 x 2.94" x 0.28" | 10.56" | 7 |

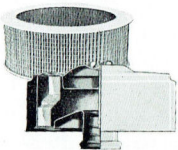

New Super Air Cleaner

Ford's new dry element Air Cleaner is pleated in accordion-fashion and is up to 90% more efficient than the oil-bath type cleaner. The filter is re-usable too, cleaning being easily accomplished by removing the element from housing and tapping firmly on a flat surface.

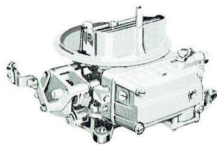

New Carburettor

The new dual-venturi carburettor is of low silhouette type—unique for its compactness and convenient unit construction. It provides a more efficient mixing of air and petrol, and its position, at the front of the engine clear of the exhaust manifold, minimises the possibility of vapour-locking.

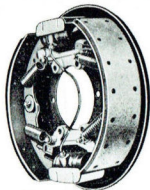

Power Brakes —STANDARD EQUIPMENT

Standard equipment, power brakes use engine vacuum to multiply braking power for stopping heavy loads. New, greater area, long wearing, replaceable brake linings of asbestos provide more resistance to heat, long life, durability and smoother brake action.

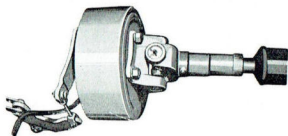

New, internal shoe parking brake

There are 3 big advantages with Ford's new transmission mounted internal expanding shoe type parking brake: 1. It provides positive holding on grades under all load conditions; 2. It's design means greater heat dissipation and more positive action for emergency stops; 3. Internal design prevents entry of dirt and dust for trouble-free operation.

FORD O.H.V. V8 TRUCKS

More usable power
More chassis strength
Lasts longer, too!

Abridged Specifications

FORD O.H.V. V8 TRUCKS

ENGINE: V.8 for high operating efficiency with push rod operated overhead valves operating in special alloy iron detachable cylinder heads. Short stroke engine design. Bore 3.62. Stroke 3.30. Capacity 272 cubic inches. Compression ratio 7.1:1. R.A.C. and S.A.E. rating 42.05 H.P. Maximum B.H.P. Gross 166 @ 4400 r.p.m. Nett 139 @ 4200 r.p.m. Maximum torque: Gross 240 lbs. per ft. @ 2200-2600 r.p.m. Nett 227 lbs. per ft. @ 1800-2400 r.p.m. Engine mounted at 4 points with rubber insulated bearers.

Cylinder block and crankcase cast in one piece, of high grade chrome-nickel alloy iron. Crankcase extends 2½" below centre of crankshaft for exceptional rigidity and better oil pan and crankcase sealing. 5 main bearing precision moulded alloy iron crankshaft. Each crankshaft is dynamically balanced to provide smooth engine performance and long engine life. Replaceable steel backed copper lead main and big end bearings.

PISTONS: Tin-plated skirt aluminium alloy pistons of the autothermic design. Chrome plated top piston ring, phosphite coated lower compression ring and three piece oil control ring consisting of a serrated spring between two chrome plated rails that exert "triple pressure" for excellent oil control.

CYLINDER HEAD: Special alloy iron cylinder heads have unusually uniform distribution of metal and water passages with improved circulation for efficient cooling and maximum stability. Made of the same high grade material as the cylinder block, they have the same rate of expansion and contraction with temperature variations, thus providing freedom from distortion and leakage.

ENGINE LUBRICATION: High pressure from high capacity rota type pump with pressure feed to all main and camshaft bearings via drilled passages in engine block and to all connecting rod bearings through drilled leads in crankshaft.

OIL FILTRATION: Full flow oil filtration through a replaceable cartridge type filter element. Filter assembly base mounted integral with cylinder block on lower left-hand side of engine completely eliminating external oil lines.

CRANKCASE VENTILATION: Direct flow crankcase ventilation removes corrosive vapours by continuous circulation of clean air through the engine. Due to the location of the outlet, the system effects a self-induced flow of air so that ventilation does not depend wholly upon blast from fan and is perfected to the extent that the air flow is divided, firstly to the upper part of the engine around the rocker mechanism, then down to the crankcase, secondly around the timing chain and then to the crankcase.

OIL CAPACITY: 8 pints plus 1 pint for filter absorption.

FUEL: Holley dual downdraught low silhouette carburettor with externally adjusted fuel level setting. Acceleration pump, diaphragm operated and power valve vacuum operated for maximum power with fuel economy performance. Manually controlled choke with stroke and throttle controls interconnected.

FUEL SUPPLY: By mechanical pump, driven from engine camshaft. Special filter element fitted

in glass bowl protects fuel supply to engine and is readily removable for periodic service or maintenance.

FUEL TANK CAPACITY: 14.5 Imperial gallons.

COOLING SYSTEM: High capacity series flow cooling system resulting in direct water flow at high velocity from the front to rear of block on each bank then through connecting passages in the cylinder heads over each combustion chamber and back to the outlet at the front for closer temperature control and eliminating hot spots, with the consequent reduction of tendency for engine to detonate. Four-bladed fan, diameter 18 ins., with pressed steel cowling.

COOLING SYSTEM CAPACITY: 17.5 Imperial quarts.

ELECTRICAL: Coil and distributor with combined centrifugal and vacuum control for automatic advance and retard. Conical tapered seat 18 mm. spark plugs. The conical tapered plug seat eliminates the need for gaskets and once the plug is properly tightened, no torque loss is encountered providing positive seating under high combustion pressures. 12-volt electrical system with four headlight system.

BATTERY: 12 volt 55 amp. per hr capacity at 20 hr rate. Negative terminal grounded.

CLUTCH: Single dry disc type. Diameter 11 ins. Spring loaded centre for smooth drive Frictional area 123.7 sq. ins.

GEARBOX: Cast iron casing. Four forward one reverse speed standard equipment. Five forward speed, one reverse speed—optional at extra cost. Synchronesh on top, third and second on 4-speed transmission and synchronisers on top, fourth, third and second on five-speed transmission. Constant mesh helical gears in top, three, speeds on four speed box and on top four speeds on five speed box.

GEAR-BOX RATIOS: Four-speed—First 6.40:1. Second 3.09:1. Third 1.69:1. Fourth 1:1. Reverse 7.82:1. Five-speed—First 7.58:1. Second 4.38:1. Third 2.40:1. Fourth 1.48:1. Fifth 1:1. Reverse 7.51:1.

POWER TAKE-OFF: Six bolt S.A.E. Power take-off on right-hand side of four-speed transmission and 6 bolt standard S.A.E. Power take-off both sides of five speed.

GEARBOX CAPACITY: Two open propeller shafts provide smooth flow of power from the transmission to the rear axle. All units of the drive line are carefully designed and installed in the chassis with the proper inclination to produce straight line drive with minimum angularity between light and loaded positions. Sliding coupling and front-end of rear shaft.

REAR AXLE: Full floating axle shafts forged integral with outer flanges. Axle shafts are chrome molybdenum steel forgings, heat-treated for toughness and high torsional strength. The planetary two-speed rear axle utilizes a spiral bevel type drive gear and pinion, the pinion being straddle mounted. Axle ratios: High 6.33:1, Low 8.81:1.

FRONT AXLE: Front axles feature high-strength, heat-treated, forged alloy steel; axle centres of rigid I-Beam type construction. Sections are increased at all high stress points. Reverse Elliot steering knuckles feature bolted-on stronger steering arms as well as stronger spindles.

FRAME: Deep channel section side-members parallel ladder-type frame construction. Cross members flanged "U" type with Alligator Jaw and Channel Sections. The parallel type frame allows installation of both engine and steering gear mechanism within the side rails.

SPRINGS: Semi-elliptic springs front and rear. Front springs are wide span with low deflection rate for desirable riding qualities and stability. The rear springs are long and wide for proper resilience and to carry the recommended load capacity under the most severe conditions. Dimensions—Main 52" x 2.50". Auxiliary 37" x 2.50".

STEERING BOX: Worm and roller-type steering gear design provides quick response to wheel, steady handling ease and rugged construction. Both Worm and sector shaft are adjustable to provide long dependable service. The sector shaft in steering mechanism has a long bearing surface and bronze bushings. Steering gear ratio: 20.4:1.

STEERING WHEEL: Steel core with hard moulded rubber cover and grip. 18 in. diameter, centre horn button.

STEERING BALL SOCKETS: Tie-rod ends are spring loaded, ball socket type for automatic take-up of normal ball-socket wear.

STEERING BOX CAPACITY: 0.625 imperial pints.

TURNING CIRCLE DIAMETERS: 130° W/B 45' (right) 47' (left). 154° W/B 52' (right), 54' (left). 172° W/B 57' (right), 59' (left). 192° W/B 63' (right), 65' (left). All measurements approximate—taken to centre line of outer wheel.

BRAKES: Full hydraulic system, vacuum boosted, operated by pedal acting on front and rear wheels. Total area drum lining front and rear combined 388.4 sq. ins.

VACUUM POWER UNIT: Provides accurately controlled braking power with normal pedal application for smooth, positive stopping. The diaphragm-type unit is connected hydraulically into the truck's braking system between the master cylinder and the brake wheel cylinders.

HANDBRAKES: Internal shoe parking brake. Parking brake drum is mounted on the rear of the drive line at the rear of transmission. The brake drum is bolted to the flange of the front universal joint and the internal expanding shoe is self energising.

FRONT BRAKES: Single anchor self energising uni-servo type. Dimensions: (Drum diameter and lining width—thickness) 14" x 2½" x 1".

REAR BRAKES: Two cylinder self energising action for either forward or reverse stopping. Dimensions: (Drum diameter x lining width thickness) 15" x 4" x 1".

Abridged Specifications

FORD O.H.V. V8 TRUCKS

WHEELS AND TYRES: Wheels are of the 3 piece pressed steel disc type with split-spring steel locking rings. Rim sizes 6.5 x 20 — 7 wheels. Standard tyre equipment—front, dual rear. Spare tyre optional. Tyre sizes: 8.25 x 20 x 10-ply. Optional tyre sizes available at extra cost.

CAB: All steel welded structure of 3 man design. Boxed section construction in windshield header and filler posts for maximum safety and durability.

CAB MOUNTING: Rubber pads and rubber insulated bolts at each front corner and level-action links in torsion-type rubber bushings at rear corners, provide 4-point stability, insulating cab from vibration, noise and frame weave.

INSTRUMENT PANEL: Curved panel with easy-to-read full vision instrument cluster, containing fuel gauge, oil pressure and charge indicator lights, speedometer and temperature gauge.

DOORS: All steel construction mounted on concealed goose-necked hinges. Door checks built into hinges hold doors in open position. Push button handles with rugged rota-type safety latches. Continuous weather stripping around doors with weather sealed Air Wing Vents.

WINDOWS: Wrap-around windshield, full width rear window over 4 ft. wide, large door windows giving total glass area of 2100 sq. ins. for all-round visibility.

SEATING: Full width seat with non-sag coil springs. Improved basic construction gives added support for back and knees. 4-inch finger tip seat adjustment. Cushion and back rest covered in durable Vinyl.

VENTILATION: Hi-Dri cowl type ventilation. Air flow through cowl side panel vents fully controlled by controls on instrument panel.

CHASSIS EQUIPMENT: Included as standard in addition to items mentioned above: Hood, cowl and dash assembly; front fenders; Hi-dri cowl ventilator; steel toe board; Instrument panel; speedometer; water temperature gauge; oil pressure

warning light; fuel gauge; ash receptacle; glove box; hand throttle; Horn; Electric windshield wipers; treadle-type accelerator pedal; long arm outside rear view mirror on chassis/cab; internal sun visor; standard tools in bag, hydraulic jack.

Ford Motor Company of Australia Pty. Ltd., whose policy is one of continuous improvement, reserves the right, subject to such regulations as may from time to time apply, to change specifications and prices at any time without notice or incurring liability to purchasers.

GENERAL DIMENSIONS: F 600

| | | | |
|---|--------|--------|--------|
| Wheelbase | 154" | 172" | 192" |
| Track, Front | 62.75 | 62.75 | 62.75 |
| Track, Rear | 67.10 | 67.10 | 67.10 |
| Max. Overall Length (to end of frame) | 228 | 267.5 | 287.15 |
| Max. Height (to top of Cab—Loaded) | 81.80 | 81.80 | 81.80 |
| Max. Width of Vehicle (Bumpers) | 77.6 | 77.6 | 77.6 |
| Max. Length along Loading Floor | | | |
| Max. Width across Wheel Floor | | | |
| Max. Width above Wheel Arches | | | |
| Max. Width inside Wheel Arches | | | |
| Across Loading Floor Max. Height of Sides from Loading Floor to Tonneau Cover | | | |
| Width of Tailgate Opening | | | |
| Width across Front Seat | 56.70 | 56.70 | 56.70 |
| Back of Cab to End of Frame | 123.02 | 162.52 | 180 |

OWING TO THE VARIANCE OF BODY TYPES SPECIFICATIONS SUPPLIED ON REQUEST

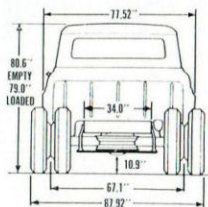

CHASSIS DIMENSIONS

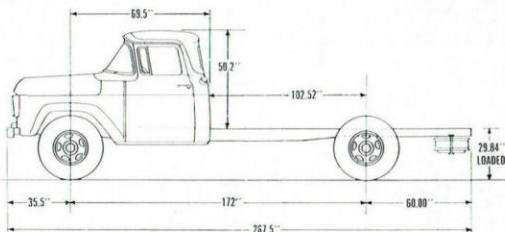
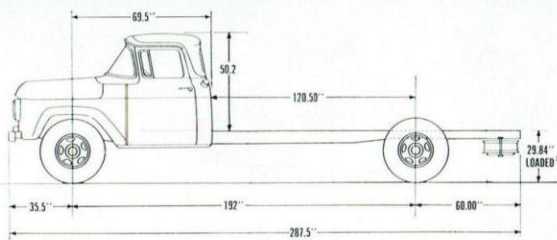
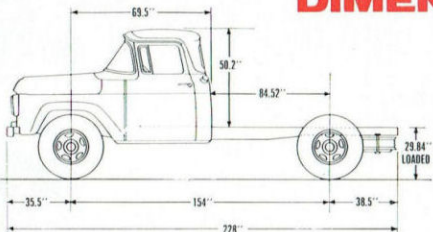

FORD MOTOR COMPANY OF AUSTRALIA PTY. LTD.

(Incorporated in Victoria) Reg. Office: Geelong, Victoria

Abridged Specifications

FORD O.H.V. V8 TRUCKS

ENGINE: V.8 for high operating efficiency with push rod operated overhead valves operating in special alloy iron detachable cylinder heads. Short stroke engine design. Bore 3.62. Stroke 3.30. Capacity 272 cubic inches. Compression ratio 7.1:1. R.A.C. and S.A.E. rating 42.05 H.P. Maximum B.H.P. Gross 166 @ 4400 r.p.m. Nett 139 @ 4200 r.p.m. Maximum torque: Gross 240 lbs. per ft. @ 2200-2600 r.p.m. Nett 227 lbs. per ft. @ 1800-2400 r.p.m. Engine mounted at 4 points with rubber insulated bearers.

Cylinder block and crankcase cast in one piece, of high grade chrome-nickel alloy iron. Crankcase extends 2 1/2" below centre of crankshaft for exceptional rigidity and better oil pan and crankcase sealing. 5 main bearing precision moulded alloy iron crankshaft. Each crankshaft is dynamically balanced to provide smooth engine performance and long engine life. Replaceable steel backed copper lead main and big end bearings.

PISTONS: Tin-plated skirt aluminium alloy pistons of the autothermic design. Chrome plated top piston ring, phosphate coated lower compression ring and three piece oil control ring consisting of a serrated spring between two chrome plated rails that exert "triple pressure" for excellent oil control.

CYLINDER HEAD: Special alloy iron cylinder heads have unusually uniform distribution of metal and water passages with improved circulation for efficient cooling and maximum stability. Made of the same high grade material as the cylinder block, they have the same rate of expansion and contraction with temperature variations, thus providing freedom from distortion and leakage.

ENGINE LUBRICATION: High pressure from high capacity rota type pump with pressure feed to all main and camshaft bearings via drilled passages in engine block and to all connecting rod bearings through drilled leads in crankshaft.

OIL FILTRATION: Full flow oil filtration through a replaceable cartridge type filter element. Filter assembly base mounted integral with cylinder block on lower left-hand side of engine completely eliminating external oil lines.

CRANKCASE VENTILATION: Direct flow crankcase ventilation removes corrosive vapours by continuous circulation of clean air through the engine. Due to the location of the outlet, the system effects a self-induced flow of air so that ventilation does not depend wholly upon blast from fan and is perfected to the extent that the air flow is divided, firstly to the upper part of the engine around the rocker mechanism, then down to the crankcase, secondly around the timing chain and then to the crankcase.

OIL CAPACITY: 8 pints plus 1 pint for filter absorption.

FUEL: Holley dual downdraught low silhouette carburettor with externally adjusted fuel level setting. Acceleration pump, diaphragm operated and power valve vacuum operated for maximum power with fuel economy performance. Manually controlled choke with stroke and throttle controls interconnected.

FUEL SUPPLY: By mechanical pump, driven from engine camshaft. Special filter element fitted

in glass bowl protects fuel supply to engine and is readily removable for periodic service or maintenance.

FUEL TANK CAPACITY: 14.5 Imperial gallons.

COOLING SYSTEM: High capacity series flow cooling system resulting in direct water flow at high velocity from the front to rear of block on each bank then through connecting passages in the cylinder heads over each combustion chamber and back to the outlet at the front for closer temperature control and eliminating hot spots, with the consequent reduction of tendency for engine to detonate. Four-bladed fan, diameter 18 ins., with pressed steel cowling.

COOLING SYSTEM CAPACITY: 17.5 Imperial quarts.

ELECTRICAL: Coil and distributor with combined centrifugal and vacuum control for automatic advance and retard. Conical tapered seat 18 mm. spark plugs. The conical tapered plug seat eliminates the need for gaskets and once the plug is properly tightened, no torque loss is encountered providing positive seating under high combustion pressures. 12-volt electrical system with four headlight system.

BATTERY: 12 volt 55 amp. per hr capacity at 20 hr rate. Negative terminal grounded.

CLUTCH: Single dry disc type. Diameter 11 ins. Spring loaded centre for smooth drive Frictional area 123.7 sq. ins.

GEARBOX: Cast iron casing. Four forward one reverse speed standard equipment. Five forward speed, one reverse speed—optional at extra cost. Synchromesh on top, third and second on 4-speed transmission and synchronisers on top, fourth, third and second on five-speed transmission. Constant mesh helical gears in top, three, speeds on four speed box and on top four speeds on five speed box.

GEAR-BOX RATIOS: Four-speed—First 6.40:1. Second 3.09:1. Third 1.69:1. Fourth 1:1. Reverse 7.82:1. Five-speed—First 7.58:1. Second 4.38:1. Third 2.40:1. Fourth 1.48:1. Fifth 1:1. Reverse 7.51:1.

POWER TAKE-OFF: Six bolt S.A.E. Power take-off on right-hand side of four-speed transmission and 6 bolt standard S.A.E. Power take-off both sides of five speed.

GEARBOX CAPACITY: Two open propeller shafts provide smooth flow of power from the transmission to the rear axle. All units of the drive line are carefully designed and installed in the chassis with the proper inclination to produce straight line drive with minimum angularity between light and loaded positions. Sliding coupling and front-end of rear shaft.

REAR AXLE: Full floating axle shafts forged integral with outer flanges. Axle shafts are chrome molybdenum steel forgings, heat-treated for toughness and high torsional strength. The planetary two-speed rear axle utilizes a spiral bevel type drive gear and pinion, the pinion being straddle mounted. Axle ratios: High 6.33:1, Low 8.81:1.

FRONT AXLE: Front axles feature high-strength, heat-treated, forged alloy steel; axle centres of rigid I-Beam type construction. Sections are increased at all high stress points. Reverse Elliot steering knuckles feature bolted-on stronger steering arms as well as stronger spindles.

FRAME: Deep channel section side-members parallel ladder-type frame construction. Cross members flanged "U" type with Alligator Jaw and Channel Sections. The parallel type frame allows installation of both engine and steering gear mechanism within the side rails.

SPRINGS: Semi-elliptic springs front and rear. Front springs are wide span with low deflection rate for desirable riding qualities and stability. The rear springs are long and wide for proper resilience and to carry the recommended load capacity under the most severe conditions. Dimensions—Main 52" x 2.50". Auxiliary 37" x 2.50".

STEERING BOX: Worm and roller-type steering gear design provides quick response to wheel, steady handling ease and rugged construction. Both Worm and sector shaft are adjustable to provide long dependable service. The sector shaft in steering mechanism has a long bearing surface and bronze bushings. Steering gear ratio: 20:4:1.

STEERING WHEEL: Steel core with hard moulded rubber cover and grip. 18 in. diameter, centre horn button.

STEERING BALL SOCKETS: Tie-rod ends are spring loaded, ball socket type for automatic take-up of normal ball-socket wear.

STEERING BOX CAPACITY: 0.625 imperial pints.

TURNING CIRCLE DIAMETERS: 130" W/B 45" (right) 47" (left), 154" W/B 52" (right), 54" (left), 172" W/B 57" (right), 59" (left), 192" W/B 63" (right), 65" (left). All measurements approximate—taken to centre line of outer wheel.

BRAKES: Full hydraulic system, vacuum boosted, operated by pedal acting on front and rear wheels. Total area drum lining front and rear combined 388.4 sq. ins.

VACUUM POWER UNIT: Provides accurately controlled braking power with normal pedal application for smooth, positive stopping. The diaphragm-type unit is connected hydraulically into the truck's braking system between the master cylinder and the brake wheel cylinders.

HANDBRAKES: Internal shoe parking brake. Parking brake drum is mounted on the rear of the drive line at the rear of transmission. The brake drum is bolted to the flange of the front universal joint and the internal expanding shoe is self energising.

FRONT BRAKES: Single anchor self energising uni-servo type. Dimensions: (Drum diameter and lining width—thickness) 14" x 2 1/2" x 1".

REAR BRAKES: Two cylinder self energising action for either forward or reverse stopping. Dimensions: (Drum diameter x lining width thickness) 15" x 4" x 1".

Abridged Specifications

FORD O.H.V. V8 TRUCKS

WHEELS AND TYRES: Wheels are of the 3 piece pressed steel disc type with split-spring steel locking rings. Rim sizes 6.5 x 20—7 wheels. Standard tyre equipment—front, dual rear. Spare tyre optional. Tyre sizes: 8.25 x 20 x 10-ply. Optional tyre sizes available at extra cost.

CAB: All steel welded structure of 3 man design. Boxed section construction in windshield header and filler posts for maximum safety and durability.

CAB MOUNTING: Rubber pads and rubber insulated bolts at each front corner and level-action links in torsion-type rubber bushings at rear corners, provide 4-point stability, insulating cab from vibration, noise and frame weave.

INSTRUMENT PANEL: Curved panel with easy-to-read full vision instrument cluster, containing fuel gauge, oil pressure and charge indicator lights, speedometer and temperature gauge.

DOORS: All steel construction mounted on concealed goose-necked hinges. Door checks built into hinges hold doors in open position. Push button handles with rugged rota-type safety latches. Continuous weather stripping around doors with weather sealed Air Wing Vents.

WINDOWS: Wrap-around windshield, full width rear window over 4 ft. wide, large door windows giving total glass area of 2100 sq. ins. for all-round visibility.

SEATING: Full width seat with non-sag coil springs. Improved basic construction gives added support for back and knees. 4-inch finger tip seat adjustment. Cushion and back rest covered in durable Vinyl.

VENTILATION: Hi-Dri cowl type ventilation. Air flow through cowl side panel vents fully controlled by controls on instrument panel.

CHASSIS EQUIPMENT: Included as standard in addition to items mentioned above: Hood, cowl and dash assembly; front fenders; Hi-dri cowl ventilator; steel toe board; Instrument panel; speedometer; water temperature gauge; oil pressure

warning lights; fuel gauge; ash receptacle; glove box; hand throttle; Horn; Electric windshield wipers; treadle-type accelerator pedal; long arm outside rear view mirror on chassis/cab; internal sun visor; standard tools in bag, hydraulic jack.

Ford Motor Company of Australia Pty. Ltd., whose policy is one of continuous improvement, reserves the right, subject to such regulations as may from time to time apply, to change specifications and prices at any time without notice or incurring liability to purchasers.

| GENERAL DIMENSIONS: F 600 | | | |
|---|--------|--------|--------|
| Wheelbase | 154" | 172" | 192" |
| Track, Front | 62.75 | 62.75 | 62.75 |
| Track, Rear | 67.10 | 67.10 | 67.10 |
| Max. Overall Length (to end of frame) | 228 | 267.5 | 287.15 |
| Max. Height (to top of Cab—Loaded) | 81.80 | 81.80 | 81.80 |
| Max. Width of Vehicle (Bumpers) | 77.6 | 77.6 | 77.6 |
| Max. Length along Loading Floor | | | |
| Max. Width across Loading Floor | | | |
| Max. Width above Wheel Arches | | | |
| Max. Width inside Wheel Arches | | | |
| Across Loading Floor Max. Height of Sides from Loading Floor to Tonneau Cover | | | |
| Width of Tailgate Opening | | | |
| Width across Front Seat | 56.70 | 56.70 | 56.70 |
| Back of Cab to End of Frame | 123.02 | 162.52 | 180 |

OWING TO THE VARIANCE OF BODY TYPES SPECIFICATIONS SUPPLIED ON REQUEST

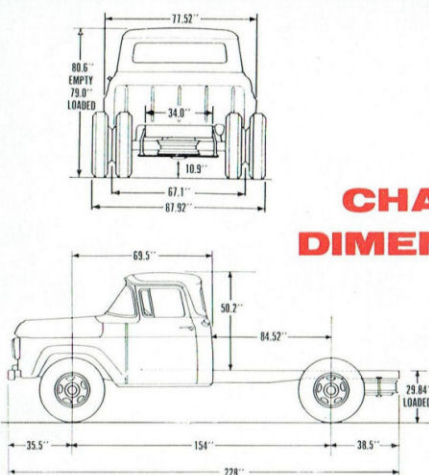

CHASSIS DIMENSIONS

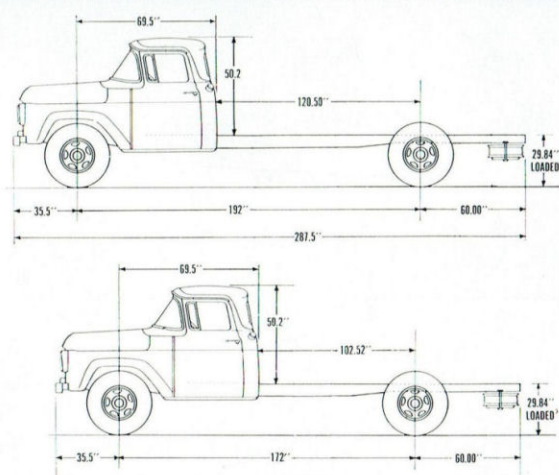

FORD MOTOR COMPANY OF AUSTRALIA PTY. LTD.

(Incorporated in Victoria) Reg. Office: Geelong, Victoria

DM33/59

NEW FORD MONEY-MAKERS

F 600



FORD O.H.V. V8 TRUCKS

Money-saving O.H.V. V8 power

Ford's O.H.V. V8 engine gives you the fullest benefit of modern Short Stroke design. Thanks to Ford's Short Stroke design, pistons travel shorter distances, at slower speeds — resulting in less wear, less power-wasting friction, and more usable power is delivered to the wheels to do your

job. In addition, moving parts last longer to keep operating costs lower! And Deep-Block construction gives greater rigidity for long life and dependable performance. This is the most efficient V8 truck engine Ford has ever built, and Ford has built more V8 engines than any other manufacturer.

Precision-moulded rocker arms for greatest durability.

Free-turn valves (both intake and exhaust) for self-cleaning, better seating, longer life.

High-turbulence combustion chambers with higher compression for greater power output.

Full-floating piston pins for longer life.

Aluminium alloy autothermic pistons with steel struts for best performance.

Full-length water jackets reduce wear. Higher capacity water pump increases cooling at low speeds.

Long-lived, copper-lead main and connecting rod bearings.

Deep engine block for greater structural rigidity, smoother engine performance.

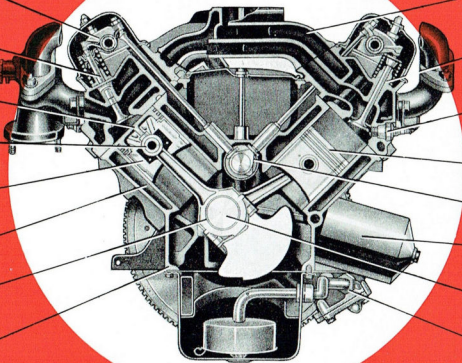

Larger short-reach intake manifold for quick, uniform fuel charge, easy starting.

Integral valve guides enable valves to run cooler, last 50% longer.

18-mm. "Turbo-Action" spark plugs — 4 Ford First, resist fouling with light loads, prolong peak power at full load.

Chrome-plated top ring prevents scuffing during break-in.

High-lift camshaft for wide valve opening.

Full-flow filter cleans all the oil, lengthens engine life.

Full-pressure lubrication of all crankshaft and connecting rod bearings for longer life.

High-capacity oil pump for positive lubrication, long life.

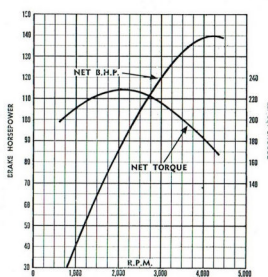

...plus the highest torque and b.h.p. in the 5-ton field!

Here is far more horsepower per cubic inch displacement, and higher, more sustained torque for tough work, long hauls, and easier cruising speeds under heavy load conditions. Net maximum b.h.p. is 139 @ 2,200 r.p.m., and the high net torque of 227 ft. lbs. is attained at the low revolutionary rate of 2,200 r.p.m. Other reasons why Ford gives you more horsepower per pound are . . . 7:1:1 compression ratio . . . 12-volt electrical system . . . iron-alloy camshaft . . . exceptionally rigid crankshaft . . . and many other engineering advances.

Greatest cab value ever — with the most in comfort, safety, and convenience

Ford Driverized Cabs are big, comfortable, and extra strong. Features are engineered in to reduce fatigue, lessen tension, and provide the nearest ride yet to sedan-like comfort.

- 1 Full wrap-around windscreen.** Now there's 1,020 square inches in Ford's wider, full wrap-around windscreen. Vision is unobstructed forward, down and to the sides.
- 2 Look at the dimensions.** There's no squeeze in this cab . . . there's more shoulder room, leg room and added head room to make driving-comfort and passenger comfort more relaxing, less fatiguing.
- 3 Inboard step.** Ford has moved the cab step up inside the door making it easier to climb aboard. It provides extra protection against water and slush—increases all-over cab strength.
- 4 Doors open wide.** Doors open almost a full yard wide—are held open by door checks. It's the easiest cab to get into and out of on the road.
- 5 Complete weather sealing.** Doors and wing vents are completely encircled by tight fitting rubber seals . . . keeping out dust, fumes, moisture and draughts.

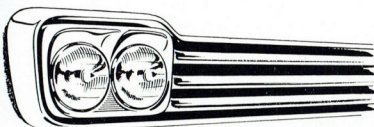
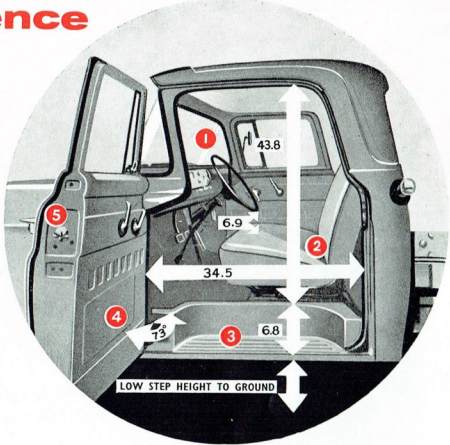

Dual headlights for safety and smartness

The dual headlight system on all Ford V8 trucks present a major improvement in lighting efficiency together with positive lighting control for added safety. Long range driving lights utilize four fixed filaments — one in each headlamp lens. The dipped beam has fixed focus spread pattern control in the outboard lights only, giving improved low-beam visibility.

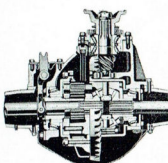

2-speed rear axle

The two-speed axles which are electrically controlled, provide, in combination with a four speed gear box 8 forward and 2 reverse drive ranges or 10 forward and 2 reverse ranges in conjunction with a five speed gear box. The 6.33:1 ratio in high is ideal for high speeds and light loads, while the 8.81:1 reduction is for maximum pull for heavy load work.

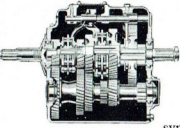

New 5-speed synchro-silent box, optional equipment

Fitting this optional synchro-silent box increases the F600's operating ease. It's 5 speeds provide a gear ratio range that means extra flexibility in heavy going.

4-speed heavy duty synchro-silent transmission standard on the F600, provides more "pulling" ability plus more flexible and economical operation. One-piece clutch and fly wheel housing provides smoother, more reliable power plan and more strength for longer life.

Ford's rugged chassis design cuts ton mile costs!

Parallel ladder-type frame construction features heavy gauge channel side members and flanged "U" type cross members. Frames are of SAE standard 34" width to facilitate mounting of standard or custom-built bodies. Deep, wide-flanged side members extend beyond the front cross member to permit direct attachment of the front bumper which also serves as a cross member. And all cross members are strategically placed in frames to resist torsional stress.

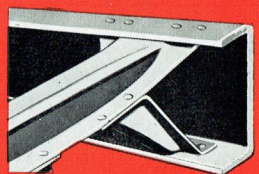

| Wheelbases | Max. Side Rail Section | Section Modulus | Number of Cross Members |
|------------|------------------------|-----------------|-------------------------|
| 154", 172" | 9.25" x 2.94" x 0.25" | 9.25" | 6 |
| 192" | 9 x 31 x 2.94" x 0.28" | 10.56" | 7 |

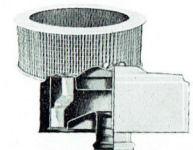

New Super Air Cleaner

Ford's new dry element Air Cleaner is pleated in accordion-fashion and is up to 90% more efficient than the oil-bath type cleaner. The filter is re-usable too, cleaning being easily accomplished by removing the element from housing and tapping firmly on a flat surface.

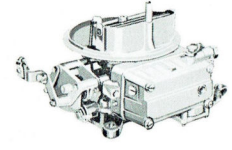

New Carburettor

The new dual-venturi carburettor is of low silhouette type—unique for its compactness and convenient unit construction. It provides a more efficient mixing of air and petrol, and its position, at the front of the engine clear of the exhaust manifold, minimises the possibility of vapour-locking.

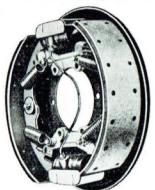

Power Brakes — STANDARD EQUIPMENT

Standard equipment, power brakes use engine vacuum to multiply braking power for stopping heavy loads. New, greater area, long wearing, replaceable brake linings of asbestos provide more resistance to heat, long life, durability and smoother brake action.

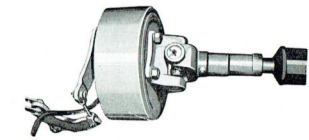

New, internal shoe parking brake

There are 3 big advantages with Ford's new transmission mounted internal expanding shoe type parking brake: 1. It provides positive holding on grades under all load conditions; 2. It's design means greater heat dissipation and more positive action for emergency stops; 3. Internal design prevents entry of dirt and dust for trouble-free operation.

FORD
O.H.V. V8 TRUCKS

More usable power
More chassis strength
Lasts longer, too!