

# NEW **F250** FORD TRUCKS

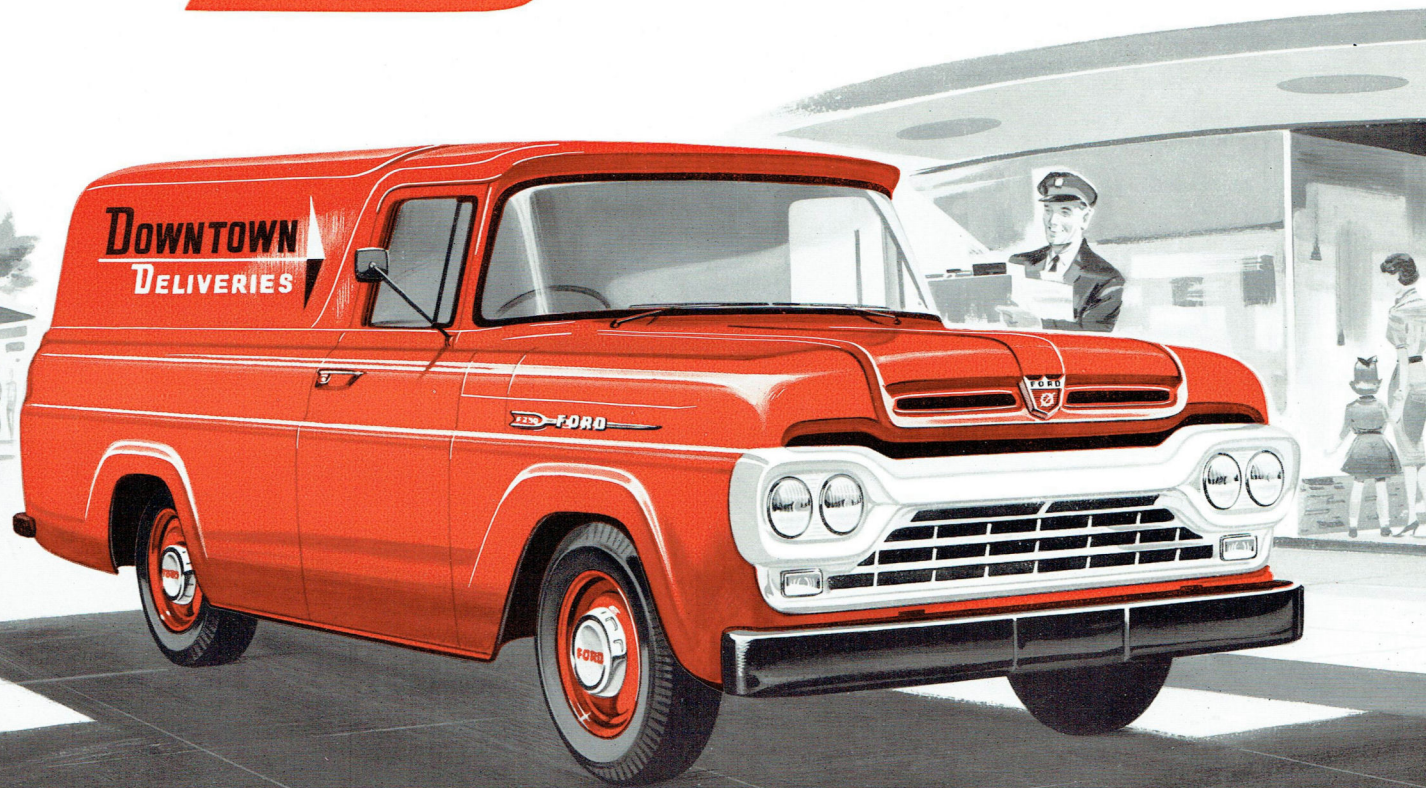

**BEST OF THE NEW — BUILT EVEN STRONGER TO LAST EVEN LONGER**

# New FORD F-250's rugged, more practical and versatile chassis design gives greater earning capacity

You save with longer life and more practical design. The parallel ladder-type frame features heavy-gauge channel side members with flanged "U" type cross members. Frames are of SAE standard 34" width to provide easier mounting for standard or custom built bodies. Side members have a "kick-up" over rear axle for low loading height ideal for medium delivery work. All cross members are strategically placed in frames to give greatest resistance to torsional stress, and the front bumper is attached directly to the side members to serve as an additional cross member.

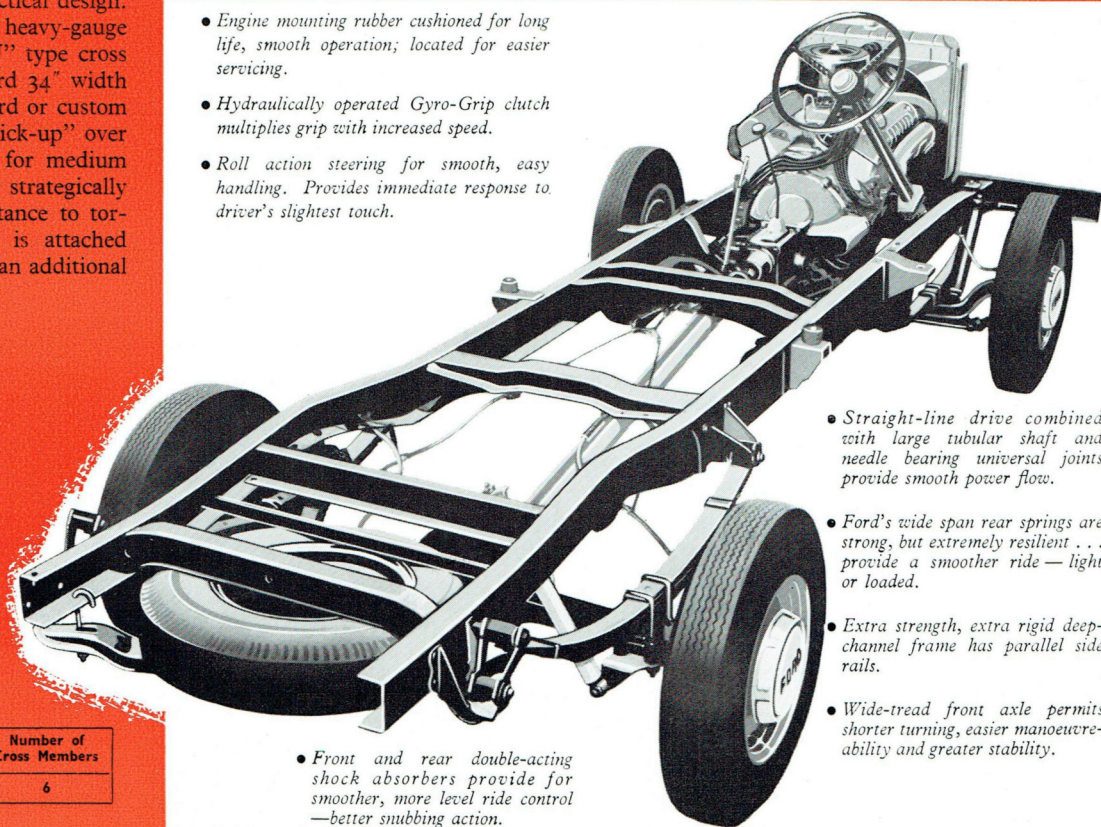
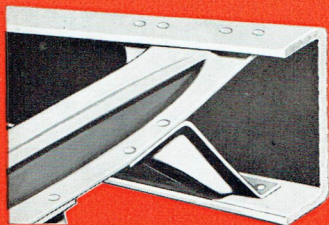

- Engine mounting rubber cushioned for long life, smooth operation; located for easier servicing.
- Hydraulically operated Gyro-Grip clutch multiplies grip with increased speed.
- Roll action steering for smooth, easy handling. Provides immediate response to driver's slightest touch.

- Straight-line drive combined with large tubular shaft and needle bearing universal joints provide smooth power flow.
- Ford's wide span rear springs are strong, but extremely resilient . . . provide a smoother ride — light or loaded.
- Extra strength, extra rigid deep-channel frame has parallel side rails.
- Wide-tread front axle permits shorter turning, easier manoeuvrability and greater stability.

- Front and rear double-acting shock absorbers provide for smoother, more level ride control — better snubbing action.

Wheelbase	Max. Side Rail Section	Section Modulus	Number of Cross Members
118"	6.0" x 2.25" x 0.19"	3.34	6

# Greatest cab value ever — with the most in comfort, safety, and convenience

Ford Driverized Cabs are big, comfortable, and extra strong. Features are engineered in to reduce fatigue, lessen tension, and provide the nearest ride yet to sedan-like comfort.

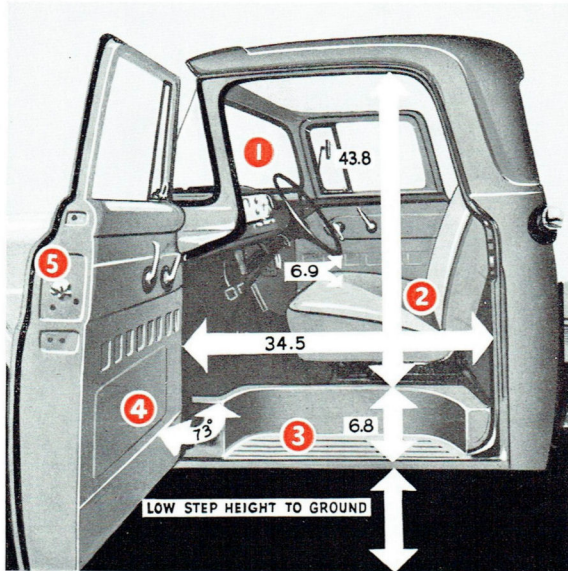
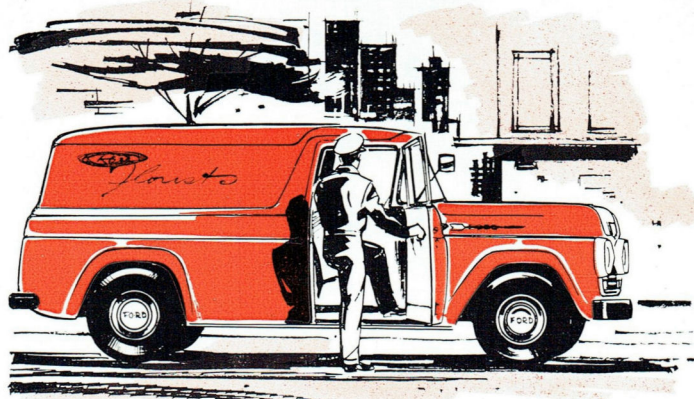

## Dual headlights for safety and efficiency

The dual headlight system on all Ford V8 trucks present a major improvement in lighting efficiency together with positive lighting control for added safety. Long range driving lights utilize four fixed filaments — one in each headlamp lens. The dipped beam has fixed focus spread pattern control in the outboard lights only, giving improved low-beam visibility.

**1. Full wrap-around windscreen.** Vision is unobstructed forward, down and to the sides, as there's 1,020 square inches in Ford's wider, full wrap-around windscreen.

**2. Look at the dimensions.** There's no squeeze in this cab . . . there's more shoulder room, leg room and added head room to make driving-comfort and passenger-comfort more relaxing, less fatiguing.

**3. Inboard step.** Ford has moved the cab step up inside the door making it easier to climb aboard. It provides extra protection against water and slush—increases overall cab strength.

**4. Doors open wide.** Doors open almost a full yard wide—are held open by door checks. It's the easiest cab to get into and out of on the road.

**5. Complete weather sealing.** Doors and wing vents are completely encircled by tight fitting rubber seals . . . keeping out dust, fumes, moisture and draughts.



# DYNAMIC NEW MONEY-SAVING V8 POWER

New F250 Ford V8 trucks 166 brake horsepower engine has the stout-hearted work capacity for medium-duty delivery work. This Ford V8 engine gives you the fullest benefit of modern short stroke design. Shorter piston travel, slower piston speeds and higher compression ratio develop high horsepower and torque with less engine effort and wear. You get more usable power for every gallon of fuel and longer engine life.

Here is more horsepower per cubic inch displacement, and higher more sustained torque for tough work, long hauls, and easier cruising speeds under heavy load conditions. Net maximum b.h.p. is 139 at 4,100 r.p.m., and the high net torque of 227 ft. lbs. is attained at the low revolutionary rate of 1,800-2,400 r.p.m.

Greater operating efficiency is achieved by combining a short-stroke design with large cylinder bores thus reducing internal friction and heat losses and increasing useful power with better economy. Large diameter cylinder bores permit greater diameter valves thereby providing excellent breathing characteristics.

Design of valves and combustion chambers contribute to the efficiency of this fine new V8 by providing fuller use of fuel and less dissipation of heat to the cooling system. Since wasted heat is lost energy this, too, means more energy per pound of fuel is converted into power.

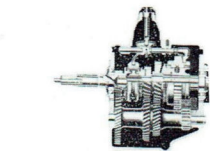
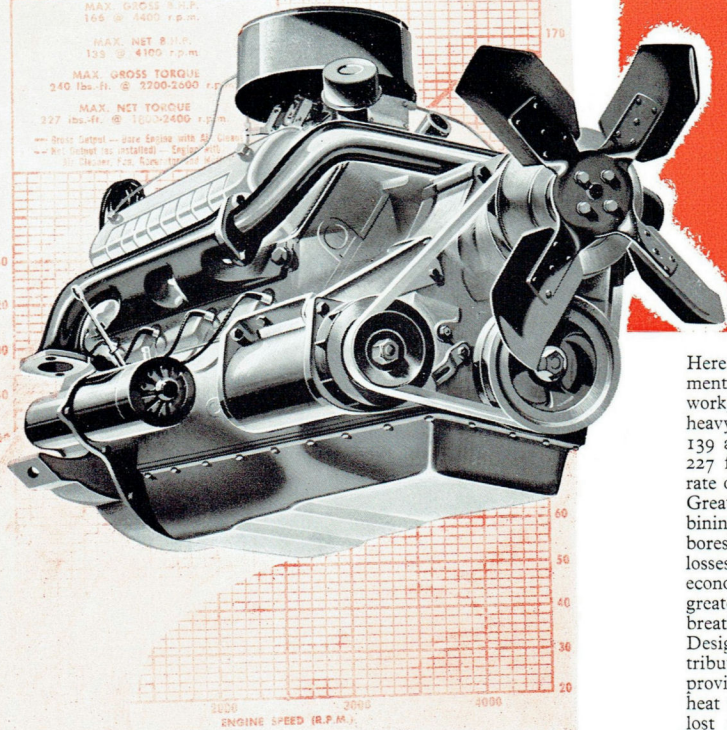
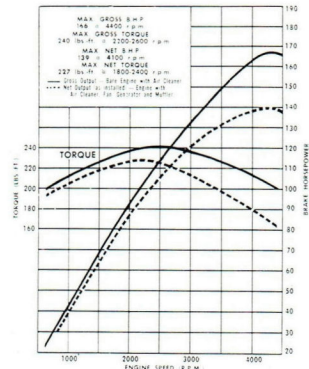

### Heavy-duty 4-speed transmission

The 4-speed synchro-silent transmission provides more "pulling" ability, more flexible and economical operation than 3-speed transmissions.

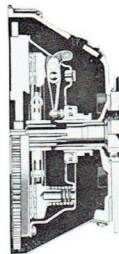

### Heavy-duty 11 inch clutch

Durable heavy-duty 11 in. clutch with 123.7 sq. inch lining area, dissipates heat faster for increased dependability and longer life. It combines with Ford's hydraulic clutch actuation for smooth easy shifting.

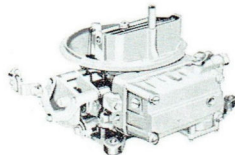

### Low Silhouette Carburettor

The new two-venturi downdraft carburettor is unique for its compactness. It provides more efficient fuel mixing and minimises the possibility of vapour locking.

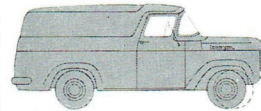

### Set-back front axle and wider track

The front axle is moved back providing a shorter wheelbase with greater manoeuvrability. Wider track provides increased stability and handling ease.

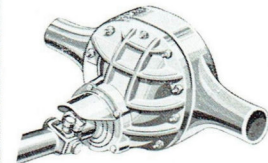

### Deep offset Hypoid Axle

Deep-offset hypoid rear axle utilizes high capacity differential gears and a straddle mounted pinion which maintains more accurate ring gear tooth alignment.

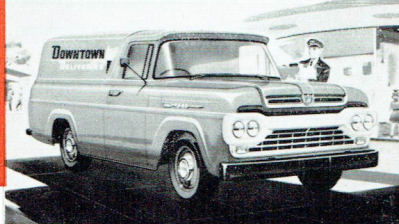

## ABRIDGED SPECIFICATIONS

# FORD F250 TRUCKS

**ENGINE:** V8 for high operating efficiency with push rod operated overhead valves operating in special alloy iron detachable cylinder heads. Short stroke engine design. Bore 3.62 in. Stroke 3.30 in. Capacity 272 cubic ins. Compression ratio 7:1:1 R.A.C. and S.A.E. rating 42.05 H.P. Maximum B.H.P. Gross 166 @ 4400 r.p.m. Net 139 @ 4100 r.p.m. Maximum torque: Gross 240 lbs. per ft. @ 2200-2600 r.p.m. Net 227 lbs. per ft. @ 1800-2400 r.p.m. Engine mounted at 4 points with rubber insulated bearers.

Cylinder block and crankcase cast in one piece, of high grade chrome-nickel alloy iron. Crankcase extends 2 $\frac{1}{2}$ " below centre of crankshaft for exceptional rigidity and better oil pan and crankcase sealing. 5 main bearing precision moulded alloy iron crankshaft. Each crankshaft is dynamically balanced to provide smooth engine performance and long engine life. Replaceable steel backed copper lead main and big end bearings.

**PISTONS:** Tin-plated skirt aluminium alloy pistons of the autothermic design. Chrome plated top piston ring, phosphate coated lower compression ring and three piece oil control ring consisting of a serrated spring between two chrome plated rails that exert "triple pressure" for excellent oil control.

**CYLINDER HEAD:** Special alloy iron cylinder heads have unusually uniform distribution of metal and water passages with improved circulation for efficient cooling and maximum stability. Made of the same high grade material as the cylinder block, they have the same rate of expansion and contraction with temperature variations, thus providing freedom from distortion and leakage.

**ENGINE LUBRICATION:** High pressure from high capacity rota type pump with pressure feed to all main and camshaft bearings via drilled passages in engine block and to all connecting rod bearings through drilled leads in crankshaft.

**OIL FILTRATION:** Full flow oil filtration through a replaceable cartridge type filter element. Filter assembly base mounted integral with cylinder block on lower left-hand side of engine completely eliminating external oil lines.

**CRANKCASE VENTILATION:** Direct flow crankcase ventilation removes corrosive vapours by continuous circulation of clean air through the engine. Due to the location of the outlet, the system effects a self-induced flow of air so that ventilation does not depend wholly upon blast from fan and is perfected to the extent that the air flow is divided, firstly to the upper part of the engine around the rocker mechanism, then down to the crankcase, secondly around the timing chain and then to the crankcase.

**OIL CAPACITY:** 8 pints plus 2 pints for filter absorption.

**FUEL:** Holley dual downdraught low silhouette carburettor with externally adjusted fuel level setting. Acceleration pump,

diaphragm operated and power valve vacuum operated for maximum power with fuel economy performance. Manually controlled choke with stroke and throttle controls inter-connected.

**FUEL SUPPLY:** By mechanical pump, driven from engine camshaft. Special filter element fitted in glass bowl protects fuel supply to engine and is readily removable for periodic service or maintenance.

**FUEL TANK CAPACITY:** 14.5 Imperial gallons.

**COOLING SYSTEM:** High capacity series flow cooling system resulting in direct water flow at high velocity from the front to rear of block on each bank then through connecting passages in the cylinder heads over each combustion chamber and back to the outlet at the front for closer temperature control and eliminating hot spots, with the consequent reduction of tendency for engine to detonate. Four-bladed fan, diameter 18 ins. with pressed steel cooling.

**COOLING SYSTEM CAPACITY:** 17.5 Imperial quarts.

**ELECTRICAL:** 12 volt electrical system. Coil and distributor with combined centrifugal and vacuum control for automatic advance and retard. Conical tapered seat 18 mm. spark plugs. The conical tapered plug seat eliminates the need for gaskets and once the plug is properly tightened, no torque loss is encountered providing positive seating under high combustion pressures. Dual headlight system.

**BATTERY:** 12 volt 55 amp. per hr. capacity at 20 hr. rate. Negative terminal grounded.

**CLUTCH:** Single dry disc type. Diameter 11 ins. Spring loaded centre for smooth drive. Frictional area 123.7 sq. ins.

**GEARBOX:** Cast iron casing. Four forward one reverse speed standard equipment. Synchromesh on top, third and second. Constant mesh helical gears in top three speeds.

**GEAR BOX RATIOS:** Four speed — First 6.40:1. Second 3.09:1. Third 1.69:1. Fourth 1:1. Reverse 7.82:1.

**POWER TAKE OFF:** Six bolt S.A.E. Power take-off on right-hand side of transmission.

**GEARBOX CAPACITY:** 6.7 Imperial Pints.

**DRIVE LINES:** Two open propeller shafts provide smooth flow of power from the transmission to the rear axle. All units of the drive line are carefully designed and installed in the chassis with the proper inclination to produce straight line drive with minimum angularity between light and loaded positions. Sliding coupling at front-end of rear shaft.

**REAR AXLE:** Full floating axle. Shafts forged integral with outer flanges. Axle shafts are chrome molybdenum steel forgings, heat-treated for toughness and high torsional strength. The rear axle utilises a hypoid type drive gear and pinion. Pinion Gear is straddle mounted to ensure accurate alignment under high torque loads. Axle ratio — 4.88:1.

**FRONT AXLE:** Front axles feature high-strength, heat-treated forged alloy steel; axle centres of rigid I-beam type construction. Sections are increased at all high stress points. Reverse Elliot steering knuckles feature bolted-on stronger steering arms as well as stronger spindles.

**FRAME:** Deep channel section side members, parallel ladder-type frame construction. Cross members flanged "U" type with Alligator Jaw and Channel Sections. The parallel type frame allows installation of both engine and steering gear mechanism within the protection of side rails.

**SPRINGS:** Semi-elliptic springs front and rear. Front springs are wide span with low deflection rate for desirable riding qualities and stability. The rear springs are long and wide for proper resilience and to carry the recommended load capacity under the most severe conditions. Dimensions — Front: 45" x 2". Rear: 52" x 2 $\frac{1}{4}$ ".

**STEERING BOX:** Worm and roller-type steering gear design provides quick response to wheel, steady handling ease and rugged construction. Both worm and sector shaft are adjustable to provide long dependable service. The sector shaft in steering mechanism has a long bearing surface and bronze bushings. Steering gear ratio: 18.2:1.

**STEERING WHEEL:** Steel core with hard moulded rubber cover and grip. 18 in. diameter, centre horn button.

**STEERING BALL SOCKETS:** Tie-rod ends are spring loaded, ball socket type for automatic take-up of normal ball-socket wear.

**STEERING BOX CAPACITY:** .625 Imperial Pints.

**TURNING CIRCLE DIAMETERS:** Right to left — 40.0". Left to right — 43.2". All measurements approximate — taken to centre line of outer wheel.

**BRAKES:** Full hydraulic system, operated by pedal acting on front and rear wheels. Total area drum lining front and rear combined, 197.8 sq. ins.

**HAND BRAKES:** Equalised Parking Brake operates the rear wheel brakes mechanically by means of steel cables. An equaliser between the cables applies uniform pressure to each rear brake for straight-line emergency stops.

**FRONT BRAKES:** Single anchor duo-servo self energising type. Dimensions — (Drum diameter and lining width — thickness) 12 $\frac{1}{2}$ " x 2" x  $\frac{1}{4}$ ".

**REAR BRAKES:** Single anchor duo-servo self energising type. Dimensions — (Drum diameter and lining width — thickness) 12 $\frac{1}{2}$ " x 2" x  $\frac{1}{4}$ ".

**WHEELS AND TYRES:** Wheels are of the drop centre type. Rim sizes — 17 x 5.50 — 5 wheels. Standard tyre equipment — front, rear and Spare (All tube and tyre combination). Tyre sizes — 7.50 x 17 — 8 ply.

## ABRIDGED SPECIFICATIONS

# FORD F250 TRUCKS

**CAB:** All steel welded structure of 3 man design. Boxed section construction in wind-shield header and filler posts for maximum safety and durability.

**CAB MOUNTING:** Rubber pads and rubber insulated bolts at each front corner and level-action links in torsion-type rubber bushings at rear corners, provide 4-point stability, insulating cab from vibration, noise and frame weave.

**INSTRUMENT PANEL:** Curved panel with easy-to-read full vision instrument cluster containing fuel gauge, oil pressure and charge indicator lights, speedometer and temperature gauge.

**DOORS:** All steel construction mounted on concealed goose-necked hinges. Door checks built into hinges hold doors in open position. Push button handles with rugged rota-type safety latches. Continuous weather stripping around doors with weather sealed Air Wing Vents.

**WINDOWS:** Wrap-around windshield, full width rear window over 4 ft. wide, large door

windows giving total glass area of 2100 sq. ins. for all-round visibility.

**SEATING:** Full width seat with non-sag coil springs. Improved basic construction gives added support for back and knees. 4-inch finger tip seat adjustment. Cushion and back rest covered in durable Vinyl.

**VENTILATION:** Hi-Dri cowl type ventilation. Air flow through cowl side panel vents fully controlled by controls on instrument panel.

**CHASSIS EQUIPMENT:** Included as standard in addition to items mentioned above: Hood, cowl and dash assembly; front fenders; Hi-dri cowl ventilators; steel toe Board; instrument panel; speedometer; water temperature gauge; oil pressure warning light; fuel gauge; ash receptacle; glove box; horn; electric wind-shield wipers; treadle-type accelerator pedal; long arm outside rear view mirror on chassis cab; internal sun visor; standard tools in bag, hydraulic jack.

*Ford Motor Company of Australia Pty. Ltd. whose policy is one of continuous improvement, reserves the right, subject to such regulations as may from time to time apply, to change specifications and prices at any time without notice or incurring liability to purchasers.*

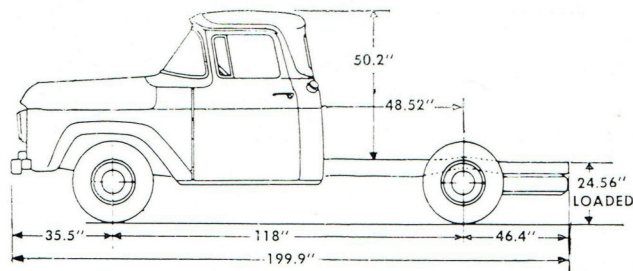
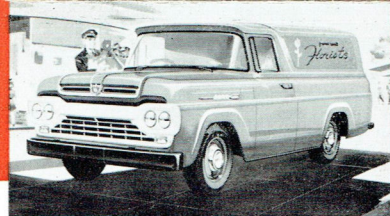

## CHASSIS DIMENSIONS

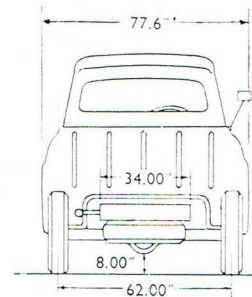

### GENERAL DIMENSIONS: F250

Wheelbase ... ..	118"
Track, Front ... ..	62"
Track, Rear ... ..	62"
Max. Overall Length (to end of frame) ... ..	199.9"
Max. Width of Vehicle (bumpers) ... ..	77.6"
Width across Front seat ... ..	56.7"
Back of Cab to End of Frame ... ..	94.9"

**FORD MOTOR COMPANY OF AUSTRALIA PTY. LTD.**

(Incorporated in Victoria) Reg. Office: Geelong, Victoria

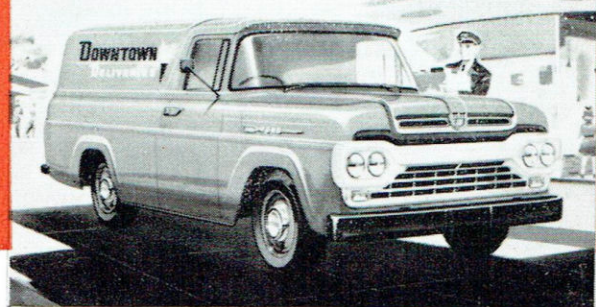

# ABRIDGED SPECIFICATIONS FORD F250 TRUCKS

**ENGINE:** V8 for high operating efficiency with push rod operated overhead valves operating in special alloy iron detachable cylinder heads. Short stroke engine design. Bore 3.62 in. Stroke 3.30 in. Capacity 272 cubic ins. Compression ratio 7.1:1 R.A.C. and S.A.E. rating 42.05 H.P. Maximum B.H.P. Gross 166 @ 4400 r.p.m. Net 139 @ 4100 r.p.m. Maximum torque: Gross 240 lbs. per ft. @ 2200-2600 r.p.m. Net 227 lbs. per ft. @ 1800-2400 r.p.m. Engine mounted at 4 points with rubber insulated bearers. Cylinder block and crankcase cast in one piece, of high grade chrome-nickel alloy iron. Crankcase extends 2½" below centre of crankshaft for exceptional rigidity and better oil pan and crankcase sealing. 5 main bearing precision moulded alloy iron crankshaft. Each crankshaft is dynamically balanced to provide smooth engine performance and long engine life. Replaceable steel backed copper lead main and big end bearings.

**PISTONS:** Tin-plated aluminium alloy pistons of the autothermic design. Chrome plated top piston ring, phosphate coated lower compression ring and three piece oil control ring consisting of a serrated spring between two chrome plated rails that exert "triple pressure" for excellent oil control.

**CYLINDER HEAD:** Special alloy iron cylinder heads have unusually uniform distribution of metal and water passages with improved circulation for efficient cooling and maximum stability. Made of the same high grade material as the cylinder block, they have the same rate of expansion and contraction with temperature variations, thus providing freedom from distortion and leakage.

**ENGINE LUBRICATION:** High pressure from high capacity rota type pump with pressure feed to all main and camshaft bearings via drilled passages in engine block and to all connecting rod bearings through drilled leads in crankshaft.

**OIL FILTRATION:** Full flow oil filtration through a replaceable cartridge type filter element. Filter assembly base mounted integral with cylinder block on lower left-hand side of engine completely eliminating external oil lines.

**CRANKCASE VENTILATION:** Direct flow crankcase ventilation removes corrosive vapours by continuous circulation of clean air through the engine. Due to the location of the outlet, the system effects a self-induced flow of air so that ventilation does not depend wholly upon blast from fan and is perfected to the extent that the air flow is divided, firstly to the upper part of the engine around the rocker mechanism, then down to the crankcase, secondly around the timing chain and then to the crankcase.

**OIL CAPACITY:** 8 pints plus 2 pints for filter absorption.

**FUEL:** Holley dual downdraught low silhouette carburettor with externally adjusted fuel level setting. Acceleration pump,

diaphragm operated and power valve vacuum operated for maximum power with fuel economy performance. Manually controlled choke with stroke and throttle controls interconnected.

**FUEL SUPPLY:** By mechanical pump, driven from engine camshaft. Special filter element fitted in glass bowl protects fuel supply to engine and is readily removable for periodic service or maintenance.

**FUEL TANK CAPACITY:** 14.5 Imperial gallons.

**COOLING SYSTEM:** High capacity series flow cooling system resulting in direct water flow at high velocity from the front to rear of block on each bank then through connecting passages in the cylinder heads over each combustion chamber and back to the outlet at the front for closer temperature control and eliminating hot spots, with the consequent reduction of tendency for engine to detonate. Four-bladed fan, diameter 18 ins. with pressed steel cowling.

**COOLING SYSTEM CAPACITY:** 17.5 Imperial quarts.

**ELECTRICAL:** 12 volt electrical system. Coil and distributor with combined centrifugal and vacuum control for automatic advance and retard. Conical tapered seat 18 mm. spark plugs. The conical tapered plug seat eliminates the need for gaskets and once the plug is properly tightened, no torque loss is encountered providing positive seating under high combustion pressures. Dual headlight system.

**BATTERY:** 12 volt 55 amp. per hr. capacity at 20 hr. rate. Negative terminal grounded.

**CLUTCH:** Single dry disc type. Diameter 11 ins. Spring loaded centre for smooth drive. Frictional area 123.7 sq. ins.

**GEARBOX:** Cast iron casing. Four forward one reverse speed standard equipment. Synchromesh on top, third and second. Constant mesh helical gears in top three speeds.

**GEAR BOX RATIOS:** Four speed — First 6.40:1. Second 3.09:1. Third 1.69:1. Fourth 1:1. Reverse 7.82:1.

**POWER TAKE OFF:** Six bolt S.A.E. Power take-off on right-hand side of transmission.

**GEARBOX CAPACITY:** 6.7 Imperial Pints.

**DRIVE LINES:** Two open propeller shafts provide smooth flow of power from the transmission to the rear axle. All units of the drive line are carefully designed and installed in the chassis with the proper inclination to produce straight line drive with minimum angularity between light and loaded positions. Sliding coupling at front-end of rear shaft.

**REAR AXLE:** Full floating axle. Shafts forged integral with outer flanges. Axle shafts are chrome molybdenum steel forgings, heat-treated for toughness and high torsional strength. The rear axle utilises a hypoid type drive gear and pinion. Pinion Gear is straddle mounted to ensure accurate alignment under high torque loads. Axle ratio — 4.88:1.

**FRONT AXLE:** Front axles feature high-strength, heat-treated forged alloy steel; axle centres of rigid I-beam type construction. Sections are increased at all high stress points. Reverse Elliot steering knuckles feature bolted-on stronger steering arms as well as stronger spindles.

**FRAME:** Deep channel section side members, parallel ladder-type frame construction. Cross members flanged "U" type with Alligator Jaw and Channel Sections. The parallel type frame allows installation of both engine and steering gear mechanism within the protection of side rails.

**SPRINGS:** Semi-elliptic springs front and rear. Front springs are wide span with low deflection rate for desirable riding qualities and stability. The rear springs are long and wide for proper resilience and to carry the recommended load capacity under the most severe conditions. Dimensions — Front: 45" x 2". Rear: 52" x 2½".

**STEERING BOX:** Worm and roller-type steering gear design provides quick response to wheel, steady handling ease and rugged construction. Both worm and sector shaft are adjustable to provide long dependable service. The sector shaft in steering mechanism has a long bearing surface and bronze bushings. Steering gear ratio: 18.2:1.

**STEERING WHEEL:** Steel core with hard moulded rubber cover and grip. 18 in. diameter, centre horn button.

**STEERING BALL SOCKETS:** Tie-rod ends are spring loaded, ball socket type for automatic take-up of normal ball-socket wear.

**STEERING BOX CAPACITY:** .625 Imperial Pints.

**TURNING CIRCLE DIAMETERS:** Right to left — 40.0". Left to right — 43.2". All measurements approximate — taken to centre line of outer wheel.

**BRAKES:** Full hydraulic system, operated by pedal acting on front and rear wheels. Total area drum lining front and rear combined, 197.8 sq. ins.

**HAND BRAKES:** Equalised Parking Brake operates the rear wheel brakes mechanically by means of steel cables. An equaliser between the cables applies uniform pressure to each rear brake for straight-line emergency stops.

**FRONT BRAKES:** Single anchor duo-servo self energising type. Dimensions — (Drum diameter and lining width — thickness) 12½" x 2" x ½".

**REAR BRAKES:** Single anchor duo-servo self energising type. Dimensions — (Drum diameter and lining width — thickness) 12½" x 2" x ½".

**WHEELS AND TYRES:** Wheels are of the drop centre type. Rim sizes — 17 x 5.50 — 5 wheels. Standard tyre equipment — front, rear and Spare (All tube and tyre combination). Tyre sizes — 7.50 x 17 — 8 ply.

## ABRIDGED SPECIFICATIONS FORD F250 TRUCKS

**CAB:** All steel welded structure of 3 man design. Boxed section construction in windshield header and filler posts for maximum safety and durability.

**CAB MOUNTING:** Rubber pads and rubber insulated bolts at each front corner and level-action links in torsion-type rubber bushings at rear corners, provide 4-point stability, insulating cab from vibration, noise and frame weave.

**INSTRUMENT PANEL:** Curved panel with easy-to-read full vision instrument cluster containing fuel gauge, oil pressure and charge indicator lights, speedometer and temperature gauge.

**DOORS:** All steel construction mounted on concealed goose-necked hinges. Door checks built into hinges hold doors in open position. Push button handles with rugged rota-type safety latches. Continuous weather stripping around doors with weather sealed Air Wing Vents.

**WINDOWS:** Wrap-around windshield, full width rear window over 4 ft. wide, large door

windows giving total glass area of 2100 sq. ins. for all-round visibility.

**SEATING:** Full width seat with non-sag coil springs. Improved basic construction gives added support for back and knees. 4-inch finger tip seat adjustment. Cushion and back rest covered in durable Vinyl.

**VENTILATION:** Hi-Dri cowl type ventilation. Air flow through cowl side panel vents fully controlled by controls on instrument panel.

**CHASSIS EQUIPMENT:** Included as standard in addition to items mentioned above: Hood, cowl and dash assembly; front fenders; Hi-dri cowl ventilators; steel toe Board; instrument panel; speedometer; water temperature gauge; oil pressure warning light; fuel gauge; ash receptacle; glove box; horn; electric windshield wipers; treadle-type accelerator pedal; long arm outside rear view mirror on chassis cab; internal sun visor; standard tools in bag, hydraulic jack.

*Ford Motor Company of Australia Pty. Ltd. whose policy is one of continuous improvement, reserves the right, subject to such regulations as may from time to time apply, to change specifications and prices at any time without notice or incurring liability to purchasers.*

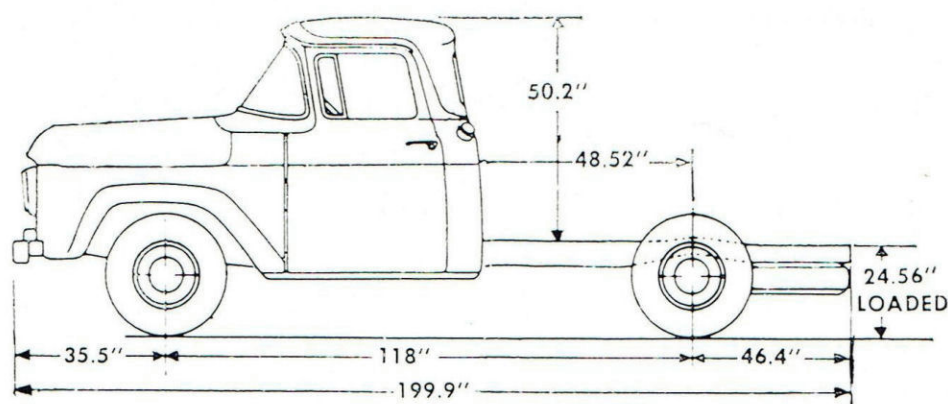

### CHASSIS DIMENSIONS

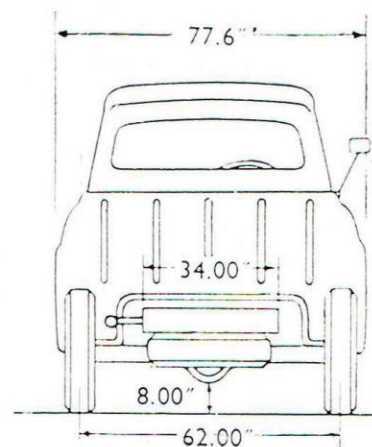

### GENERAL DIMENSIONS: F250

Wheelbase ... ..	118"
Track, Front ... ..	62"
Track, Rear ... ..	62"
Max. Overall Length (to end of frame)... ..	199.9"
Max. Width of Vehicle (bumpers)... ..	77.6"
Width across Front seat ... ..	56.7"
Back of Cab to End of Frame ... ..	94.9"

FORD MOTOR COMPANY OF AUSTRALIA PTY. LTD.  
(Incorporated in Victoria) Reg. Office: Geelong, Victoria

DM22-60

# NEW F250 FORD TRUCKS



BEST OF THE NEW — BUILT EVEN STRONGER TO LAST EVEN LONGER

# New FORD F-250's rugged, more practical and versatile chassis design gives greater earning capacity

You save with longer life and more practical design. The parallel ladder-type frame features heavy-gauge channel side members with flanged "U" type cross members. Frames are of SAE standard 34" width to provide easier mounting for standard or custom built bodies. Side members have a "kick-up" over rear axle for low loading height ideal for medium delivery work. All cross members are strategically placed in frames to give greatest resistance to torsional stress, and the front bumper is attached directly to the side members to serve as an additional cross member.

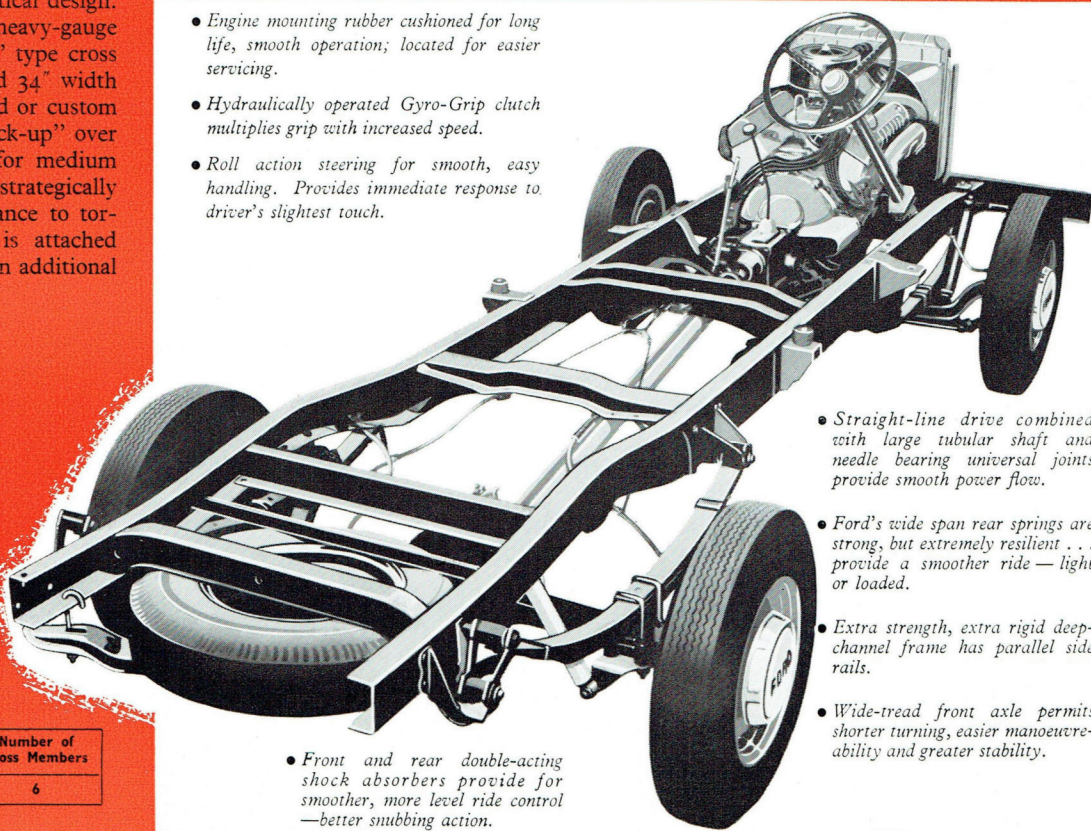
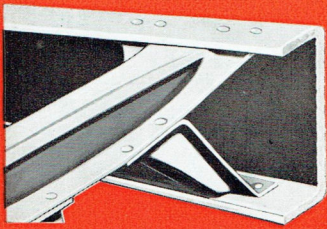

- Engine mounting rubber cushioned for long life, smooth operation; located for easier servicing.
- Hydraulically operated Gyro-Grip clutch multiplies grip with increased speed.
- Roll action steering for smooth, easy handling. Provides immediate response to driver's slightest touch.

- Straight-line drive combined with large tubular shaft and needle bearing universal joints provide smooth power flow.
- Ford's wide span rear springs are strong, but extremely resilient . . . provide a smoother ride — light or loaded.
- Extra strength, extra rigid deep-channel frame has parallel side rails.
- Wide-tread front axle permits shorter turning, easier manoeuvrability and greater stability.

• Front and rear double-acting shock absorbers provide for smoother, more level ride control — better snubbing action.

Wheelbase	Max. Side Rail Section	Section Modulus	Number of Cross Members
118"	6.0" x 2.25" x 0.19"	3.34	6

## Greatest cab value ever — with the most in comfort, safety, and convenience

Ford Driverized Cabs are big, comfortable, and extra strong. Features are engineered in to reduce fatigue, lessen tension, and provide the nearest ride yet to sedan-like comfort.

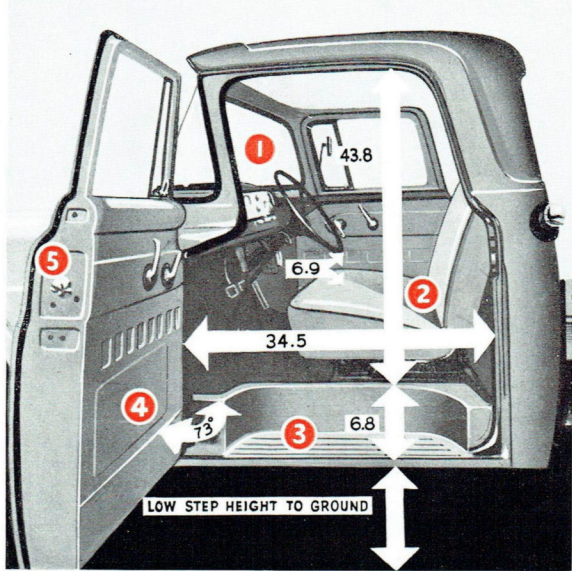
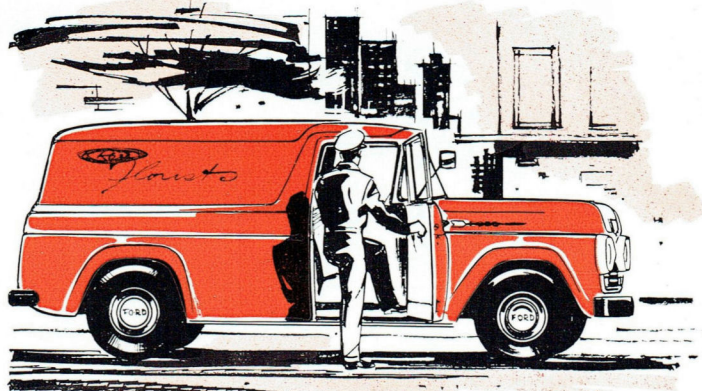

- 1. Full wrap-around windscreen.** Vision is unobstructed forward, down and to the sides, as there's 1,020 square inches in Ford's wider, full wrap-around windscreen.
- 2. Look at the dimensions.** There's no squeeze in this cab . . . there's more shoulder room, leg room and added head room to make driving-comfort and passenger-comfort more relaxing, less fatiguing.
- 3. Inboard step.** Ford has moved the cab step up inside the door making it easier to climb aboard. It provides extra protection against water and slush—increases overall cab strength.
- 4. Doors open wide.** Doors open almost a full yard wide—are held open by door checks. It's the easiest cab to get into and out of on the road.
- 5. Complete weather sealing.** Doors and wing vents are completely encircled by tight fitting rubber seals . . . keeping out dust, fumes, moisture and draughts.

## Dual headlights for safety and efficiency

The dual headlight system on all Ford V8 trucks present a major improvement in lighting efficiency together with positive lighting control for added safety. Long range driving lights utilize four fixed filaments — one in each headlamp lens. The dipped beam has fixed focus spread pattern control in the outboard lights only, giving improved low-beam visibility.



## DYNAMIC NEW MONEY-SAVING V8 POWER

New F250 Ford V8 trucks 166 brake horsepower engine has the stout-hearted work capacity for medium-duty delivery work. This Ford V8 engine gives you the fullest benefit of modern short stroke design. Shorter piston travel, slower piston speeds and higher compression ratio develop high horsepower and torque with less engine effort and wear. You get more usable power for every gallon of fuel and longer engine life.

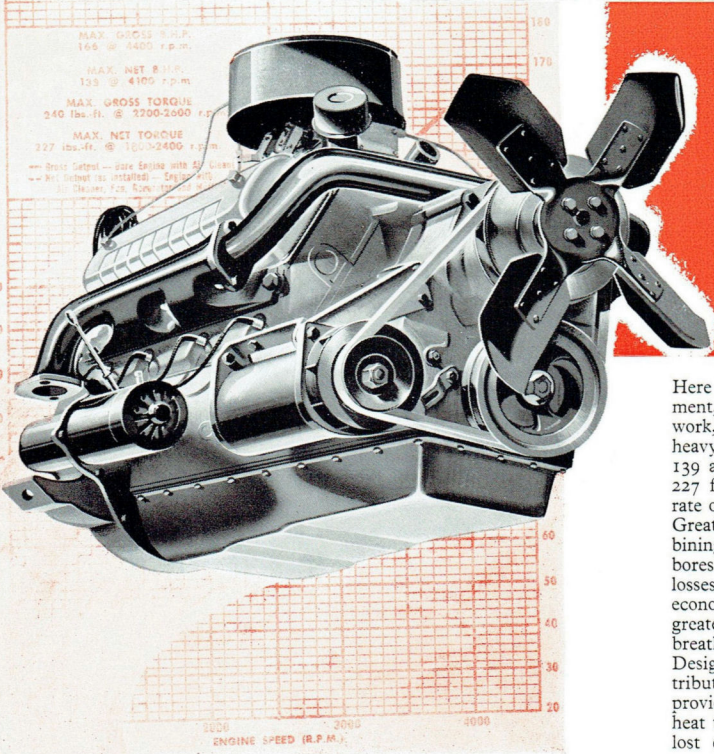

Here is more horsepower per cubic inch displacement, and higher more sustained torque for tough work, long hauls, and easier cruising speeds under heavy load conditions. Net maximum b.h.p. is 139 at 4,100 r.p.m., and the high net torque of 227 ft. lbs. is attained at the low revolutionary rate of 1,800-2,400 r.p.m. Greater operating efficiency is achieved by combining a short-stroke design with large cylinder bores thus reducing internal friction and heat losses and increasing useful power with better economy. Large diameter cylinder bores permit greater diameter valves thereby providing excellent breathing characteristics. Design of valves and combustion chambers contribute to the efficiency of this fine new V8 by providing fuller use of fuel and less dissipation of heat to the cooling system. Since wasted heat is lost energy this, too, means more energy per pound of fuel is converted into power.

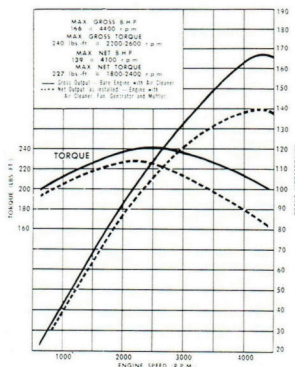

**Heavy-duty 4-speed transmission**  
 The 4-speed synchro-silent transmission provides more "pulling" ability, more flexible and economical operation than 3-speed transmissions.

**Heavy-duty 11 inch clutch**  
 Durable heavy-duty 11 in. clutch with 123.7 sq. inch lining area, dissipates heat faster for increased dependability and longer life. It combines with Ford's hydraulic clutch actuation for smooth easy shifting.

**Low Silhouette Carburettor**  
 The new two-venturi downdraft carburettor is unique for its compactness. It provides more efficient fuel mixing and minimises the possibility of vapour locking.

**Set-back front axle and wider track**  
 The front axle is moved back providing a shorter wheelbase with greater manoeuvrability. Wider track provides increased stability and handling ease.

**Deep offset Hypoid Axle**  
 Deep-offset hypoid rear axle utilizes high capacity differential gears and a straddle mounted pinion which maintains more accurate ring gear tooth alignment.