

# A POWER PRIMER





An Introduction to the Internal Combustion Engine

**AUTOMOBILE**

**AIRCRAFT**

**DIESEL**

•

Public Relations Staff  
**GENERAL MOTORS**  
DETROIT, MICHIGAN

Copyright 1955 General Motors Corporation



## Author's Note

This might be called a "sketch book of engines." Pictures have been substituted for words wherever possible, and the technical language has been held to a minimum. Our primary effort has been to explain technical facts in an interesting and non-technical manner. In doing this, it has been necessary to leave out many qualifying phrases—such as "other things remaining the same"—and to eliminate minor details in some cases in order to stress the major point. We do not believe this has resulted in any inaccuracies, but it may have left some openings for argument.

There are omissions. We are conscious of some ourselves, and no doubt many others will be discovered. All we can say is that this is a primer and internal combustion engines constitute a large subject. Our judgment may be questioned as to what has been put in and what has been left out, but we have tried to include that which would be most practical for the average person.

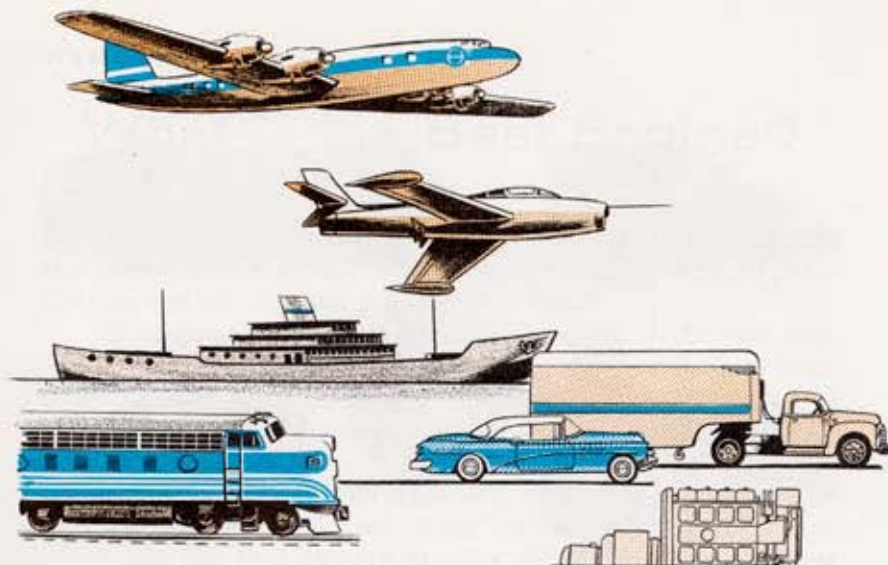

## WHAT is an Engine?

**M**OST people today have at least a nodding acquaintance with the internal combustion engine. To the great majority it is what makes an automobile go. But to others it may be the motive power for a tractor or truck, a cruiser or a tug-boat, a fighter plane or a transport. It may furnish power and light to an isolated farm, to a saw-mill in the woods, or to an entire city. For today the internal combustion engine has invaded all fields, from the bottom of the ocean to the limits of the heavens.

This great variety of names and types of engines can be very confusing—large and small engines, Diesel engines, automobile engines, jet engines, V-type engines, marine engines, radial engines, and so on. What we are trying to do in this booklet is to take away some of the mystery from these engines with different names. We are going to consider them all as internal combustion engines, and show that they are fundamentally the same. We will demonstrate that they all are based on three things—**AIR, FUEL** and **IGNITION**. We need those three things to make any internal combustion engine run. There are certain other features and principles common to every engine. We are going to point out the common features and then the principal differences in the various types of engines most generally used today.

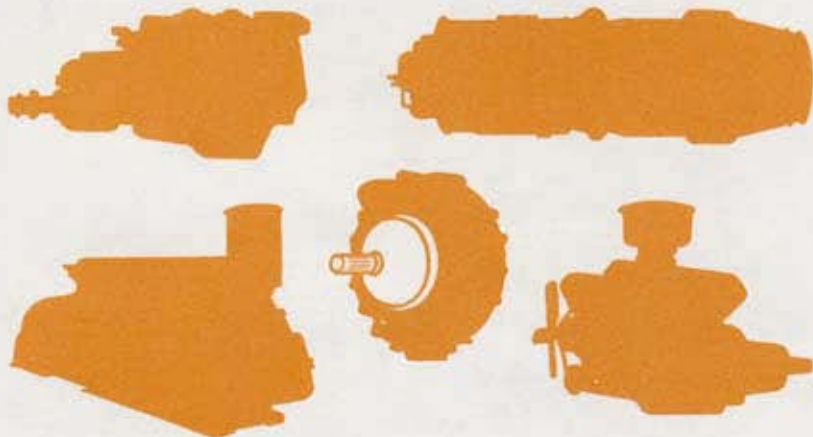

We have rather arbitrarily classified them in three groups—**automobile, aircraft, and Diesel.** We realize there are other important types, such as marine engines, stationary power plants, and so forth. But most of them are either one of the three types mentioned, with slight modifications, or are a combination of features from several classifications. So we feel this will cover the fundamentals of most internal combustion engines now in use even though some may not be mentioned by name.



### What is an INTERNAL COMBUSTION Engine?

What do we mean when we talk about internal combustion engines? "Internal combustion" is a rather cumbersome expression, but one thing can be said for it, it actually means what it says. "Internal" means "inside" or "enclosed." "Combustion" is "act of burning." Thus an internal combustion engine is one in which the fuel *burns inside*, that is, it burns inside the same

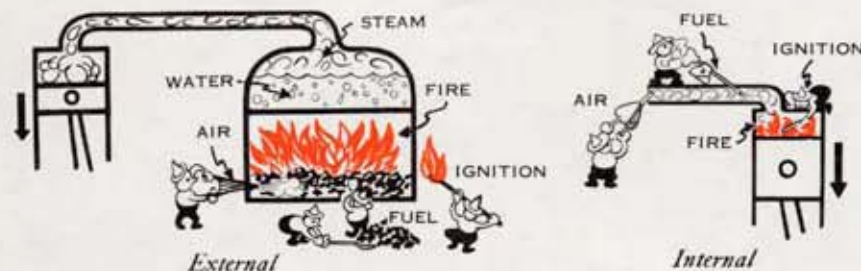

container which produces the power. In a steam engine the fuel can burn almost anywhere as long as it turns water into steam which can be led into the cylinder. That is "external combustion."

So an internal combustion engine is fundamentally a container into which we put air and fuel and start them burning.\*

Let us try a crude but simple experiment to illustrate this. We take an open glass beaker, like a drinking glass, and into it pour a few drops of gasoline—just one or two. Cover the top with a rubber diaphragm—a balloon will do. In the bottom of the beaker is a hole plugged with a cork, and running through the cork is a fuse—an ordinary firecracker fuse. We light the fuse and wait to see what will happen. The instant the fuse burns up into the beaker, the mixture of gasoline and air will be ignited and will burn very rapidly. The heat will make it try to expand, to grow larger and occupy a greater space. This will push against the diaphragm, which will bulge upward above the top of the beaker. As we might say, the balloon will be blown up. The important point is that, due to the combustion, pressure will be exerted against the diaphragm.

**Note:** This should be considered a theoretical experiment. It is not something to be tried in the kitchen. It actually does work as described, but the quantities are rather critical. A few too many drops of gasoline may cause a dangerous explosion under some conditions.



\*Inasmuch as the remainder of this booklet is concerned with only internal combustion engines, we will drop the longer term and use "engines" as meaning "internal combustion engines."



CYLINDER



PISTON



CONNECTING ROD



CRANKSHAFT

Now what do we have to do to make an engine out of this combustion? First, we will turn it upside down for convenience. The beaker is our **cylinder**, which is simply a hollow tube closed at one end. We will replace the diaphragm with a **piston**. This is a cylindrical object which slides in the tube, and as it fits closely against the wall it thus seals the other end of the cylinder.

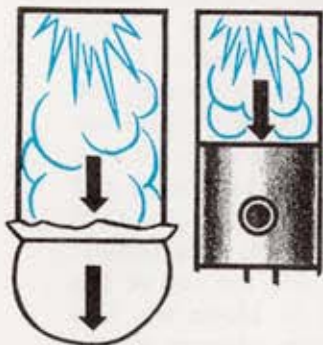

Here we have the same arrangement that we had with the beaker. If combustion takes place in the cylinder, we will have expansion of the air and pressure will be exerted on the top of the piston. This will not bulge like the diaphragm, but will slide. So all we have to do now is connect that sliding piston up in some way to get useful work from it.

For this we need a **connecting rod** and a **crankshaft**. The connecting rod is a

straight rod with one end fastened to a pin or pivot in the piston so the lower end can swing. The crankshaft is a shaft with its ends mounted in oiled bearings so it can revolve, and thus the offset portion in the middle, the **crank**, describes a circle as the shaft turns around. The lower end of the connecting rod is fastened to the crank, so it must follow the same circular path.

We have probably all ridden a bicycle at some time during our lives. The lower part of the leg of a bicycle rider is a connecting rod. The knee moves approximately up and down in a straight line. The foot follows the pedal, and therefore goes around in a circle.

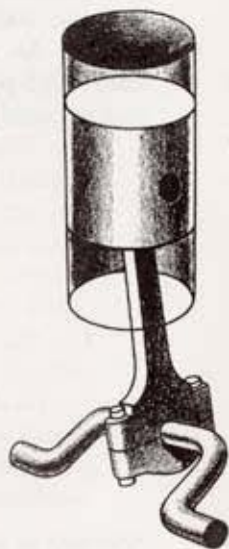

When the piston of our engine slides downward due to the pressure of the expanding gases, the upper end of the connecting rod moves downward with the piston, in a straight line. This is our knee. The lower end of the connecting rod must move down also, and the only path it can move in is the circular one prescribed by the crank. This is our foot. It moves the crank and rotates the shaft, which is what we wish to do. As often defined, the crankshaft and connecting rod combination is a mechanism for the purpose of changing straight-line, back-and-forth motion to circular, or rotary motion.



Here we have the basis for most of the engines in use today—cylinder, piston, connecting rod, and crankshaft. From it we are going to build up the various engines discussed in this booklet. The only exception is the jet engine, which is included in the Aircraft Section. The jet engine has some features different from all the other engines, but when we get into it we will find that it is still an internal combustion engine and follows most of the same principles as the rest of them.

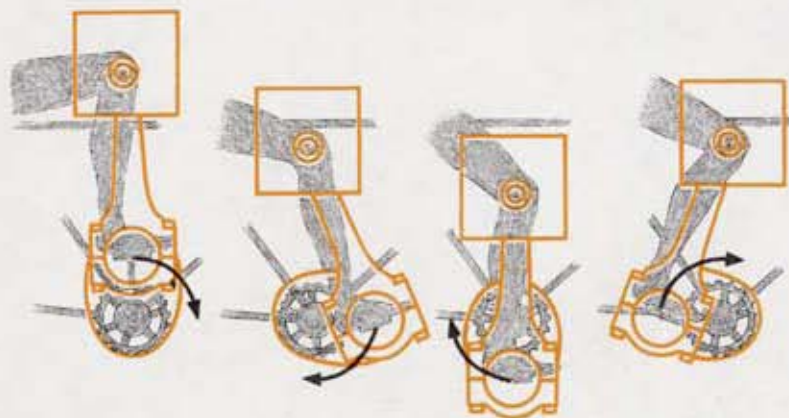

## The FOUR-CYCLE Engine

Before we start adding parts to make up these various engines, let us see what happens to the ones we already have during the actual running of an engine. They obviously must do the same things over and over again, so all we have to do is follow them through one series of events—until they begin to repeat themselves—and we know what they will be doing from then on. This one series of events we call a cycle.

Most engines today are what we call four-cycle engines. (There are important exceptions, but we will leave those until later.) What we really mean is four-stroke cycle, but the American habit of abbreviating has eliminated the middle word, at least in ordinary conversation. It makes more sense when it is included however, as it means that there are four strokes of the piston, two up and two down, to each cycle. Then it starts over again on another cycle of the same four strokes.

We cannot see a piston at work in an engine. It must be surrounded by metal in order to work. But we will take some liberties in this book. We will show "cross sections" and "cut-away sections" of engines and other mechanisms. That simply means that we cut through an engine and take part of it away so we can see what is going on inside. Or we may consider some parts to be made of glass so we can see through them, as in the next series of sketches. But no matter how we do it, we assume that the mechanism keeps on running as usual.

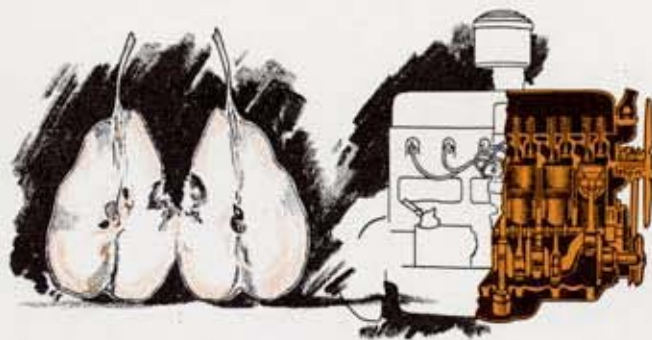
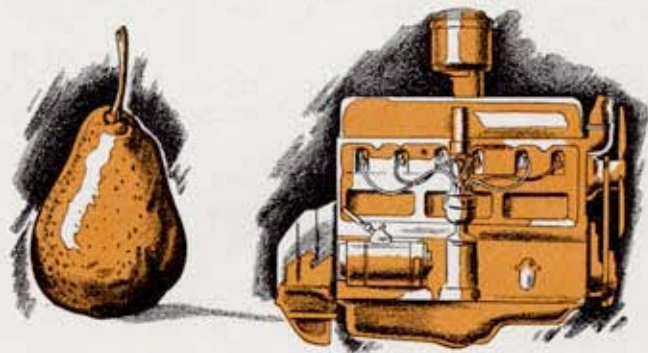

We start with the piston at the top of the cylinder, only a small space being left above it. This is as far as the crank and connecting rod will let it go. On the first stroke the piston moves down, or away from the closed end of the cylinder. This is called the **intake** stroke, because during it, air or a mixture of fuel and air is drawn into the cylinder. There are various ways of getting it in, but for the time being we will just assume that there is some kind of a "door" in the top of the cylinder which can be opened and closed as desired. When the piston is at the bottom of its stroke, that is, as far from the top of the cylinder as it can go, the cylinder is full of air or fuel-air mixture, depending on the type of engine. Note that the crankshaft has gone halfway around.

Then the intake "door" is closed and the piston starts to go up again. This second stroke is the **compression** stroke. It compresses the contents of the cylinder, so that instead of filling the whole cylinder it has all been squeezed up into that small space at the top. The piston is back where it started from, and the crankshaft has gone all the way around once. The ratio of the whole cylinder volume to the volume of that small space is called **compression ratio**. For example, suppose the cylinder held 80 cubic inches when the piston was at the bottom. We could measure this by filling it full of some liquid such as oil and measuring how much oil it took. Then we do the same thing with the piston in its uppermost position. Suppose it then took 10 cubic inches. We would say that the engine had a compression ratio of 8 to 1. That means that when the piston is at the





Compression

top the mixture in the cylinder has been squeezed to one-eighth its former volume.

This is a major difference between what took place in our little experiment with the beaker and what actually takes place in an engine. We simply mixed the fuel with the air in the beaker, covered it up, and started it burning. We found that it expanded. But in an engine that mixture is compressed before we ignite it. Then when it burns it expands a great deal more and a great deal faster, and develops more pressure. This means that we get much more power from it.

This whole matter of compression and compression ratio is an extremely important one, and we will keep running into it as we go along.

About the time the piston reaches the top of its second stroke, we ignite the mixture. It starts burning and expands, just as in the beaker. This pushes the piston down, and this third stroke is called the

**power stroke.** It is what we really have been getting ready for all the time. It is what makes the engine run and gives it power. The pressure forces the piston down to its bottom position again.

The fourth stroke of the piston is called the **exhaust**, or scavenging stroke. Another "door" in the top of the cylinder has been opened, and the hot exhaust gases—the result of burning the air and fuel—start to escape through it. As the piston rises it helps them along, pushes them out the "door." At the end of this stroke the cylinder is practically clear of the burned gases, and the

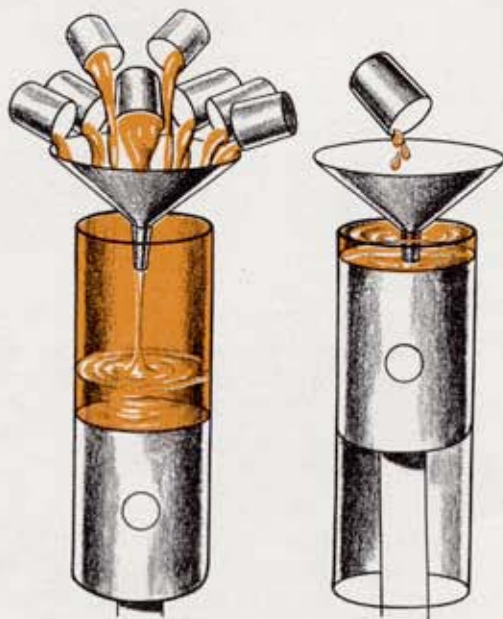

8 with the piston at the bottom.  
1 with piston at the top

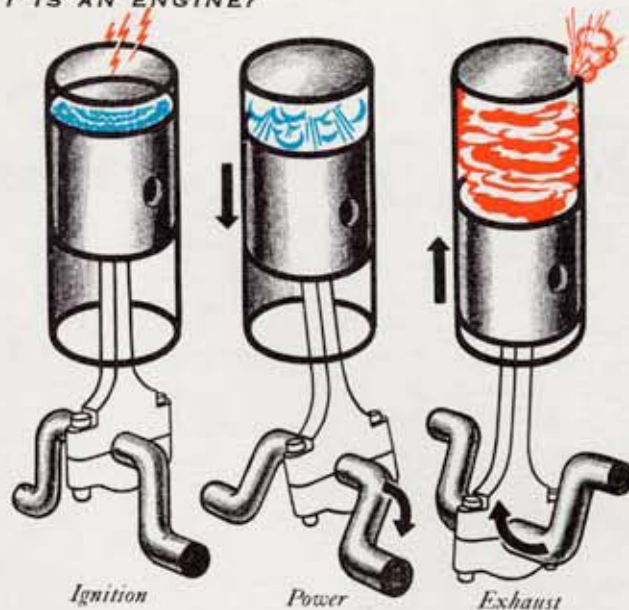

Ignition

Power

Exhaust

piston is in its top position ready to start on the first, or intake, stroke.

The crankshaft has now gone all the way around twice. This should be noted carefully. One of the principal features of the four-cycle engine is that the crankshaft makes two revolutions during every cycle. To put it another way, there is only one power stroke to two revolutions of the engine.

The four-stroke cycle is often called the Otto cycle, from the name of the man who built the first engine of this type over seventy-five years ago. To keep the essentials of this cycle straight in our minds, it is necessary only to remember four words, in their proper order.

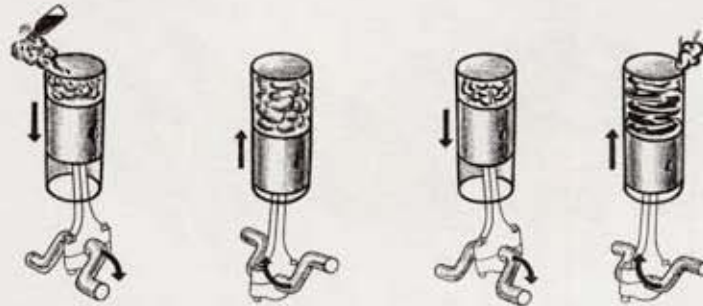

INTAKE

COMPRESSION

POWER

EXHAUST

INTAKE

COMPRESSION

POWER

EXHAUST

INTAKE

COMPRESSION

POWER

EXHAUST

INTAKE COMPRESSION POWER EXHAUST



If we analyze this to see what makes it all happen—perhaps the easiest way is to go back to our simple experiment—we find there are just three things responsible for it. As we go along we will discover that those three things are the basis for all engines, and necessary to the operation of every engine.

They are AIR, FUEL, and IGNITION.

These three must all be present before we can have an internal combustion engine. Not one or two of them, but all three. If any one is lacking, we have a dead pile of metal. When they are all on hand, we have life and power.

Our human bodies have exactly the same requirements. In order to live, we must breathe, we must provide air for our system. We must eat, for the food is our fuel. There must be some means for burning this fuel, that is, for converting the food into energy. If we are deprived of air or food, or our ignition system gets out of adjustment, our body quickly becomes just as inert or useless as an engine which lacks one or more of these necessities.

So let us look at these three fundamentals in more detail.



Everyone who has driven a car realizes that he must provide the engine with gasoline, but he may not have given much consideration to the necessity for air. That is entirely natural, as gasoline costs money, and air is there for the taking.

But in many ways, air is the more important of the two. Some people feel that the easiest way to understand an internal combustion engine is to consider it as an air pump. It is no problem to get enough fuel into an engine; its power usually depends on how much air one can crowd into it.

To the engine designer air presents greater problems than does the fuel, which is largely due to the necessity for handling far greater quantities of it. Theoretically in an automobile engine we should put into the cylinder about 15 parts of air to 1 part of gasoline—by weight. We may vary this somewhat either way, depending on whether we are more interested in power or fuel economy. So for every pound of gasoline we use, we must have 15 pounds of air. But gasoline weighs about 600 times as much as air at sea level—in other words, a pound of air takes up 600 times as much space as a pound of gasoline. So looking at it from the standpoint of volume, we must furnish 600 x 15, or 9000 cubic feet of air for every cubic foot of gasoline. This is enough air to fill an average small house. So it is easy to see that the air is bulky and hard to handle compared to the fuel.

We should mention here that it is not really the

GASOLINE



AIR





A POWER PRIMER

air we are so interested in. It is the oxygen in the air. Air is a mixture of 21 percent oxygen, 78 percent nitrogen, and 1 percent other gases. It is the oxygen which burns with the fuel. The nitrogen goes through the engine and out the exhaust unchanged. But inasmuch as air is the source of supply of the oxygen, and air is what we have to handle in designing or operating an engine, we will ignore the technicalities and continue to speak of air rather than oxygen.

There are various methods of getting this air into the cylinder, which we will show

in more detail later. The most common is through holes or passages at the top of the cylinder which are opened and closed at the proper times by "doors" called **poppet valves**. Another way is through holes or **ports** in the side of the cylinders, these being covered and uncovered automatically by the piston as it moves up and down. There have been numerous other arrangements tried, one of them, the sleeve valve, being still used to some extent. In this, a sleeve, or sometimes two, slides between the piston and the cylinder wall, controlling the flow through ports in the side of the cylinder.

Some engines use a pump, called a **blower**, or **supercharger**,

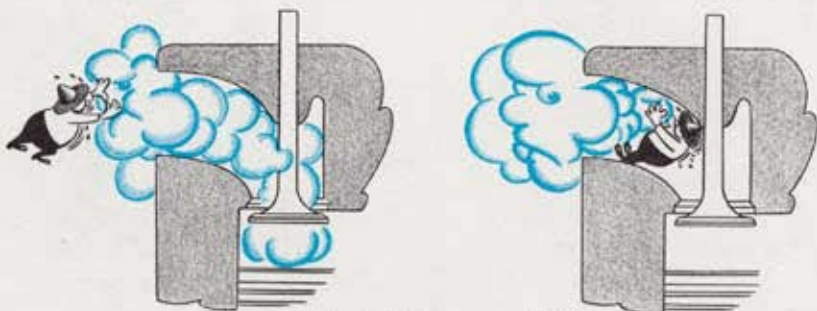
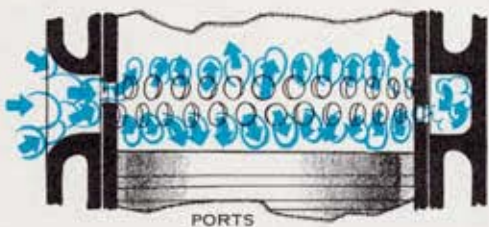
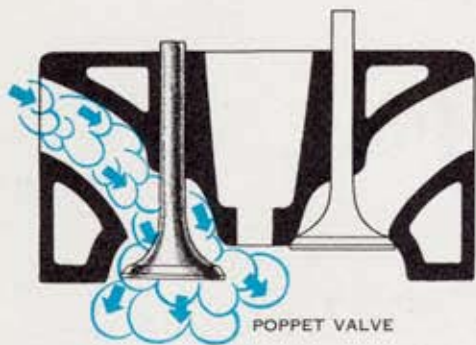

The air can be pushed in.....or pulled in

WHAT IS AN ENGINE?

to force the air into the cylinder. The automobile type engines and most of the smaller airplane engines "suck" the air in. This is not strictly true but it is a simple way to think of it. What really happens is that the piston, moving down, creates a partial vacuum in the cylinder—that is, it lowers the pressure inside—and the atmospheric pressure outside pushes air in to fill it up.

As we know, air weighs something just as every other substance does. Sometimes we think of it as being nothing, mostly because we cannot see it.

But it is real. The great mass of it surrounding the earth is pressing down on it and on us with a certain pressure at all times. It is similar to the terrific pressure on a diver or a submarine in deep water, increasing with each foot of depth. At the bottom of this ocean of air, that is, at sea level, this atmospheric pressure is about 14.7 pounds per square inch, and it is this pressure which forces air into the cylinder when the pressure inside is less than 14.7 pounds per square inch. If we ascend a mountain, or go up in an airplane, this atmospheric pressure decreases rapidly, just as the pressure in the ocean decreases as the diver approaches the surface. This brings many complications into the problem of supplying air to an engine, but we will postpone those until our discussion of aircraft engines later.



Petroleum fuels are marvelous creations of Nature and Man. They are not always appreciated fully.

First, petroleum is the second most plentiful liquid in the



world, which is a lucky thing for the internal combustion engine. Only water exceeds it in quantity. As for quality, it contains more energy—more “power”—than any explosive. We think of dynamite or nitroglycerin as the ultimate in power or explosive force. We may even flatter a powerful engine by exclaiming, “Boy, that’s dynamite!” But the potential energy in a gallon of dynamite would run a modern car less than 3 miles, as contrasted to perhaps 18 miles on a gallon of gasoline.

Gasoline and Diesel fuel are what we call **hydrocarbons**. That is, they consist of hydrogen atoms and carbon atoms joined up together in various combinations. There are hundreds of these combinations, each with its own peculiar characteristics, and our fuel is a mixture of a great many of these. Nature made petroleum that way, and it is only in recent years that Man has begun to learn how to improve on it. Some of the hydrocarbons are good fuels, some are bad. We are just beginning to find out something about what we have to do to change the bad ones over to the good ones. But that involves molecules and chemistry and a lot of long words that we will not bother with here.

There are two principal methods of getting the fuel into the engine. One is to mix it with the air outside the cylinder and push the two in together as one mixture. The other is to inject it, squirt it into the cylinder after the air is already in there. There are some variations on these, such as injecting the fuel into the air intake passage just outside the cylinder, but most of the engines in this country fall definitely into one or the other of

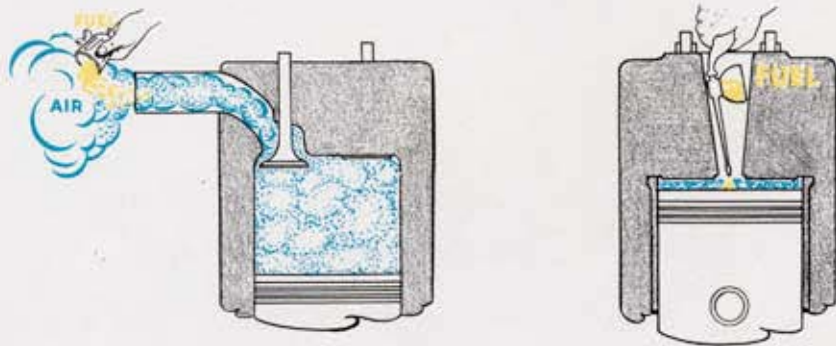

the two main classifications.

Engines using the first system are sometimes called “carburetor engines,” as it is the **carburetor** which sees to it that the proper amount of fuel is mixed with the proper amount of air. After the two have been mixed, they may be forced into the engine in any of the ways

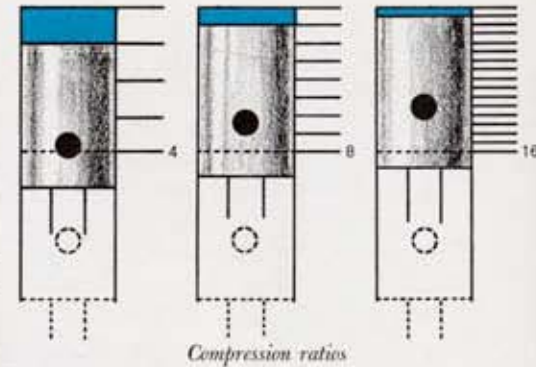

we have already mentioned for getting air into the cylinder.

Most of the automobile and aircraft type engines in the United States use carburetors. It is possible and practical to use an injection system, however, and in some other countries many aircraft engines are of this type.

All Diesel engines use fuel injection. We will see later why this is necessary. There are various kinds of injection systems, but they all have one thing in common. The air is forced into the cylinder by itself and then the fuel is shot in just before ignition. The two are mixed inside the cylinder.

It is impossible to discuss fuels without getting into the subject of compression ratio. We said that by squeezing the mixture up into one end of the cylinder before igniting it, we got more power from it. We can go further and say that the more we compress it—the harder we squeeze it—the more power we get from it. The why’s and wherefore’s are rather complicated and technical, but it is a fundamental of internal combustion engines that the higher the compression ratio, the higher the efficiency. If we squeeze the mixture in an engine so hard that it exerts a pressure of 200 pounds per square inch before ignition, we will get several times the power which we would if we squeezed it to only 100 pounds per square inch. Twenty-five or thirty years ago, 4 to 1 was a common figure for the compression ratio of automobile



of 200 pounds per square inch before ignition, we will get several times the power which we would if we squeezed it to only 100 pounds per square inch. Twenty-five or thirty years ago, 4 to 1 was a common figure for the compression ratio of automobile

engines. Today it is 8 or  $8\frac{1}{2}$  to 1. Most of the increase in power and economy which we now enjoy is due to that one fact.

Immediately the natural question is, "Why not raise the compression ratio a lot more? Why not make it 12 to 1, 15 to 1?"

There are two answers to that. First, we have done it—in the Diesel engine. There compression ratios run as high as 22 to 1. We will go into that in more detail shortly, but for the present let us consider only the gasoline engine. The second answer, for the gasoline engine, is, "The fuel of today won't let us."

For gasoline is not a perfect fuel—at least not yet. When we raise the compression ratio of an engine too high, the immediate result is detonation, or as we more commonly say, the engine knocks. This is an actual hammering inside the cylinder. It is not only annoying. It means loss of power and leads to damaged engines if carried too far. It was a mystery for many years, but was finally traced down to the fact that the fuel was not burning properly in the cylinder. Some of it was burning too fast—too much at one time. It would "explode" instead of burning smoothly. This caused the knock, or ping.

Then it was found that tetraethyl lead could be added to the gasoline which would help to prevent this too rapid burning and stop the knock. This quickly resulted in higher compression and better engines. Still later it was discovered that certain hydrocarbons were better than others from the anti-knock standpoint, and methods were developed for producing better gasoline from the same petroleum. It is these improvements in the fuel which have made possible the higher compression ratios we have today. And these in turn have meant more power and more miles per gallon, greater pay load and longer cruising range.

You have probably heard the word "octane" in connection with gasoline. The actual basis for figuring the **octane rating** of gasoline is rather complicated, but it is enough to remember that the higher the octane number of a particular gasoline, the less it will knock. It is a measure of its anti-knock quality. A high octane gasoline can be used in a higher compression engine and other things being equal, it is a better gasoline. We used to have fuels of 50 octane or lower. Now the automobile gasolines are from 85 to 95 octane, and aviation fuel well over 100. The 100 figure was originally the end of the scale, but it is now just a station along the way, and there are expectations of fuels in the future far beyond this figure.

Now just a word about Diesel fuels. They are hydrocarbons. They come from petroleum. They have many things in common with gasoline. But when it comes to knock, the Diesel engine and carburetor engine are exactly opposite. The process of burning is different, so we want the fuels different. Instead of trying to slow down the rate of combustion, we do everything we can to make a Diesel fuel burn as fast as possible. Therefore, while it starts with the same raw material, it goes through a different production process to make it better for the job it has to do. One of the greatest assets we now have is the knowledge of how to produce "tailor-made" fuels.



Our third necessity is ignition. By that we mean that something must start the fuel and air burning in the top of the cylinder, or **combustion chamber**.

To speak of the ignition system of a Diesel engine is somewhat misleading as we may be told the next moment that one of the chief differences between the gasoline engine and the Diesel engine is that the latter has no ignition system. But it does have one. It would not run if it didn't. The only thing is that we do not recognize it because it is made up of parts of the engine which are already there, the piston and cylinder.

If we compress any material it becomes warmer, and the more we compress it the hotter it gets. Diesel engines have a compression ratio of about 16 to 1 on the average. This means that the whole cylinder is filled with air and then that air is

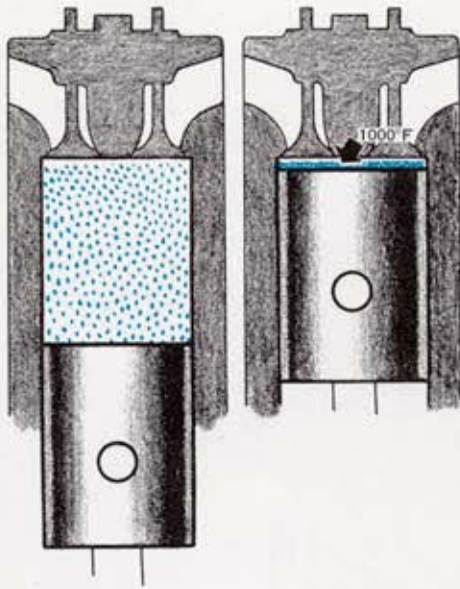

squeezed by the piston until it occupies only  $\frac{1}{16}$  the former space. This makes it very hot; the temperature of the air may reach 1000 degrees Fahrenheit. This is so hot that when the fine spray of oil is forced in as the piston approaches the top of the cylinder it begins to burn immediately. This then is our ignition system. We simply compress the air until it gets so hot that the fuel is ignited as soon as it comes in contact with it.

Now it is easier to see why we want Diesel fuels which will burn as quickly and easily as possible. We want the first tiny drop which enters the combustion chamber to start burning immediately, and each drop which comes after it to start burning in its turn. This gives smooth and powerful combustion. When the fuel does not start burning immediately, when there is a lag between injection and ignition, we get quite a few drops in the cylinder before it starts burning. Then it burns all at once, and we get a knock similar to that in a gasoline engine.

The most common way of grading Diesel fuels is according to this ignition lag, the length of time between injection and ignition. It is called **cetane rating**, and can be compared to octane rating of gasoline. The quicker burning fuel has the higher cetane number. The higher the cetane number the better the fuel from the ignition and combustion standpoint. For the different fuels used in various types of Diesel engines, the cetane number ranges from about 30 to 60.

In the gasoline engine the mixture is started burning by means of an electric spark. A **spark plug**, or sometimes two of them, fits into the wall of the combustion chamber. It has two wires, or electrodes, which extend slightly into the chamber, separated from each other by a narrow gap. High voltage elec-

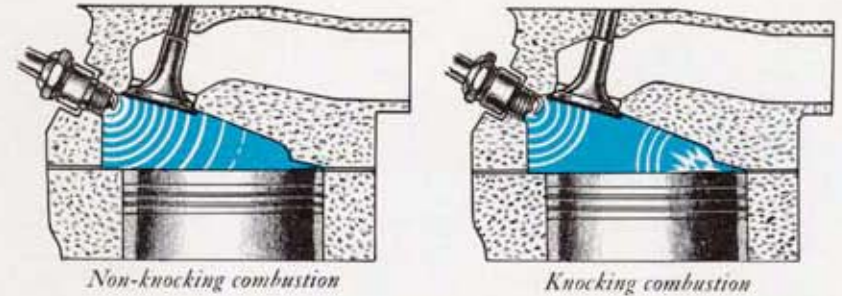

tricity is led to the spark plug at the proper time, and jumps the gap from one electrode to the other. This causes a spark which starts the fuel and air burning.

The whole chamber of gas does not burn instantaneously. The flame spreads from the spark plug, moving across the combustion chamber like a fire moves across a dry meadow on a windy day. It takes about  $\frac{1}{350}$  of a second to complete this flame travel in an average automobile cylinder.

But if we raise the compression too much, we do not get this smooth, orderly combustion. The mixture has been heated up by squeezing it so hard, and parts of the metal combustion chamber may be very hot. Before the flame has completed its travel across the chamber, the remaining unburned mixture on the far side may get so hot that it will ignite by itself and burn all at once. This creates a sudden and very uneven rise in pressure which causes the knock.

If the compression is too high, we may have more trouble. We may get pre-ignition. This means that the mixture gets so hot from compression that it starts burning before the spark occurs. We might say it is using the Diesel ignition system. But the trouble is it does not do it at the proper time. It starts burning too soon, and may cause considerable trouble because the piston is still moving upward and is not yet ready to begin the power stroke.

That is why, in the Diesel engine, we cannot mix the air and fuel outside the cylinder. We would have no control over the time of ignition. It would start burning much too soon. We must wait until the moment we want it to start burning, and then inject the fuel into the compressed air.



We have discussed air, fuel, and ignition in general terms. We have pointed out that they are present in all engines and tried to explain some of the reasons they are so necessary. This is stressed because here we have the basis for all internal combustion engines. And consequently the basis for our airplanes, our automobiles, and hundreds of other items depending on power.

In the rest of this booklet we will deal more specifically with the various types of engines in common use. We have already pointed out some differences in the way these three fundamentals are applied. As we go along we will find out that there are other differences. But we will also see that our original premise holds good—these three are the things to look out for. Whether we are designing an engine, operating an engine, “trouble-shooting,” or repairing an engine, we can do no better than keep constantly in front of our mind’s eye, in large letters

### AIR—FUEL—IGNITION



## Automobile Type Engine

THE automobile engine is the most familiar type of internal combustion engine. This is natural as there are something over 50,000,000 of them in this country. Practically everyone has some contact with them. The total horsepower represented by these engines is not only more than that of any other form of power plant—such as electrical central stations, locomotives, manufacturing plants—it is much more than all the rest put together.

Let us look at one of these engines. As installed in a car or truck, it may appear complicated at first glance. But if we go back to our basic engine unit, we find that we do not have to add a great many things in order to have all the essentials for this type of engine. We won’t have everything that you will find in the car, but we will have a complete engine—one that will run.

As we have mentioned before, this is a carburetor type engine. So let us start there, and add a carburetor first of all. This will break the gasoline up into tiny drops and mix it with the air in just the proper proportions. Now we have to get the mixture over to the cylinder. So we add an **intake manifold**, which is a pipe from the carburetor opening into the combustion chamber. But we do not want this open all the time, so we put a poppet valve in the hole which can be made to open and close at the proper times. This is the **intake valve**. We need something to ignite the mixture—a spark plug will take care of that. Now all we have to add is another poppet valve, the **exhaust valve**, which lets the hot gases out of the cylinder after they have finished their job.

There we have all the essentials of an automobile engine. We have provided it with air, fuel and ignition.

This is a four-cycle engine. We start with the piston in its top-most position, commonly called top dead center (T.D.C.). On the intake stroke, the piston moves down creating a vacuum in the cylinder. The intake

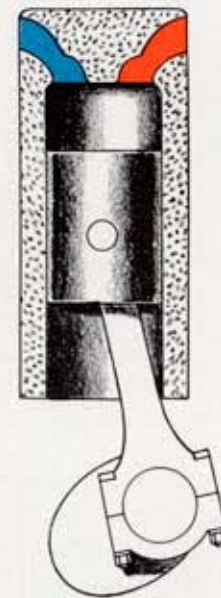

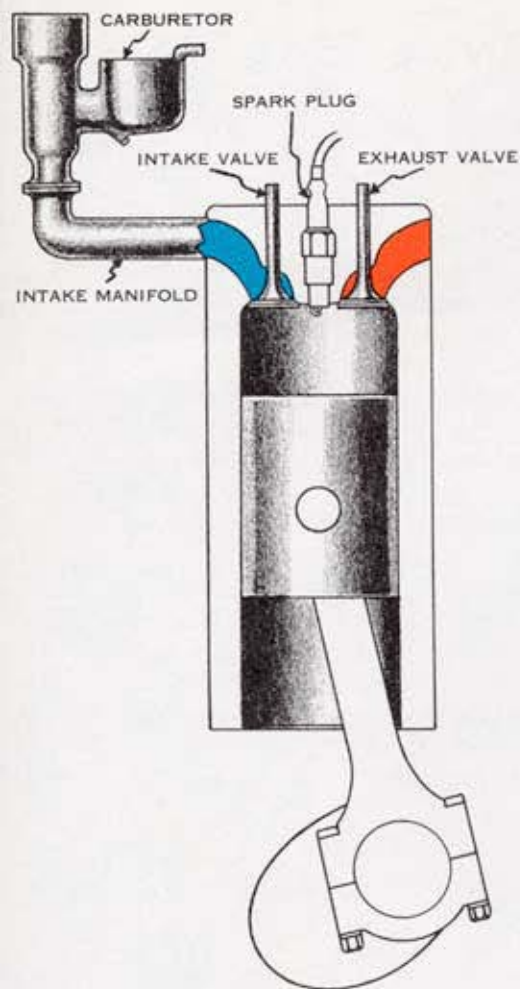

valve is open, so the mixture of gasoline and air rushes through the opening, pushed by the atmospheric pressure outside. From its bottom position, bottom dead center (B.D.C.) the piston starts up. The intake valve closes, and the mixture is compressed in the closed end of the cylinder. It is squeezed to a pressure of perhaps 200 pounds per square inch. Then the spark occurs. The burning mixture expands, and almost immediately the pressure jumps to 600 or 700 pounds per square inch, three or four times the pressure before ignition. With a piston  $3\frac{1}{2}$ " in diameter, the total pressure on the top of it will be about three tons. This enormous force pushes the piston down, which of course makes the crankshaft turn and delivers power to whatever is connected to the shaft. Both valves have been closed during the compression and power strokes, but now the exhaust valve opens. As the piston

moves up again it forces the exhaust gases out through the passage opened by the valve. As the piston gets to the top the exhaust valve closes and the intake valve opens again, ready for the beginning of the next cycle.

We have pointed out earlier that the crankshaft goes around twice during each cycle. There is only one stroke out of four that the piston delivers power to the crankshaft. All the rest of the time this is reversed—the crankshaft is acting on the piston, pushing it up and pulling it down. In order to keep the crankshaft turning around more steadily between power strokes, we fasten a

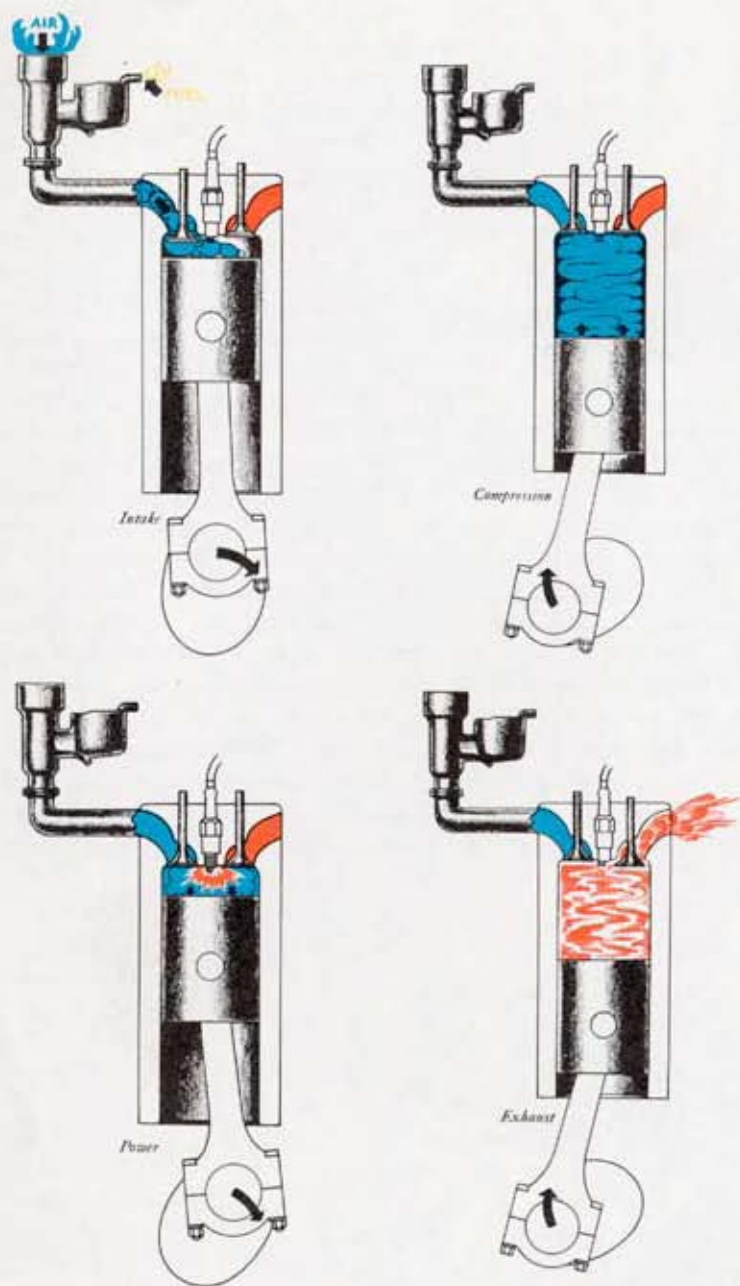

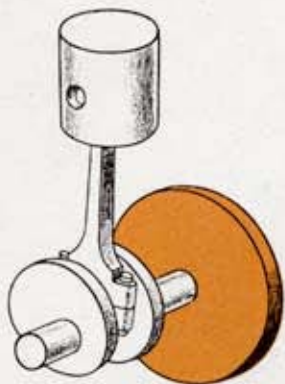

**flywheel** to one end. This is simply a heavy metal disc, or wheel, which has considerable momentum when it has been gotten spinning. This tends to keep the shaft turning more smoothly. It is somewhat the same thing as spinning a short, stubby top rather than a long, thin stick.

In an automobile we have something else which helps this situation a great deal. Thus far we have been talking of engines on the basis of one single cylinder. But we don't have "one-lungers" in vehicles any more. We have put these one-cylinder engines together, and now we have engines of four cylinders, six, eight, or even more cylinders. These may be arranged in different ways. But with all these various types of engines we must remember that we have not changed the fundamentals in any way. We have simply taken a number of the same single-cylinder engines and arranged them in different patterns. We can pick out one cylinder from any of these engines and it will operate just as we have been describing.

One way of combining these single-cylinder engines is to simply line them up, end to end. We put two together, add another one to the end, then a fourth, and so on—just as we used to line up building blocks in a row on the floor. We can fasten the ends of the crankshafts together—in reality we use one long crankshaft with a crank, or throw, for each cylinder. These cranks are arranged so that when the power stroke is occurring in one cylinder,

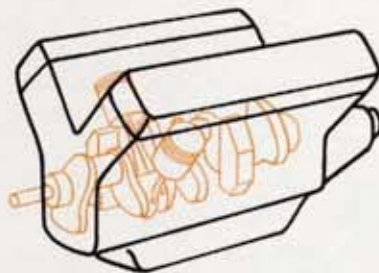
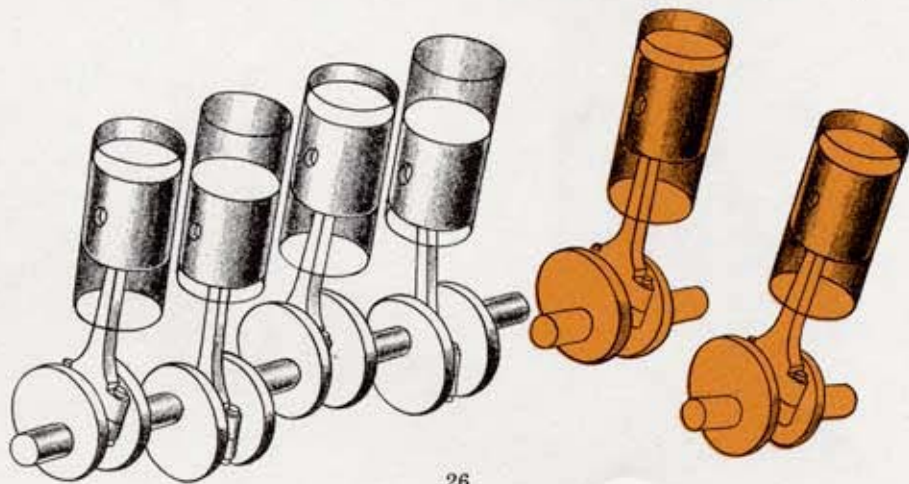

compression is going on in another, intake in a third, and exhaust in a fourth. Thus if we have four cylinders there is always one piston furnishing power to the crankshaft. With more than four cylinders there is actually an overlapping of power strokes. This makes the job of the flywheel much easier.

The other cylinder arrangement most often used in automobiles is the **V-type**. Here we have two rows of cylinders alongside each other. They are set at an angle, coming together at the bottom with the connecting rods all fastened to the same crankshaft. There are two pistons and two connecting rods for each crank. Thus in a V-8 engine we have a short crankshaft with only four cranks. It works much like two separate four-cylinder engines, but of course they must be arranged so that the various events in one row of cylinders take place at the proper time in relation to those in the other row.

In an in-line automobile engine, the cylinders are not separate units. They are made all in one piece, the **cylinder block**, cast of a special alloy iron. We might consider this piece as just a block of metal with a line of holes running through it. The **cylinder head**, which forms the closed top of the cylinders and in the present case contains the valves, is a separate piece bolted to the block. The **crankcase** is that part of the engine below the cylinder block. It holds the crankshaft in place, encloses the whirling cranks, and acts as an oil reservoir. The upper half of this is usually made in one piece with the block, with the lower part just a thin pan to seal it up. This lower part is often called the **oil pan**.

Pistons are ordinarily made of cast

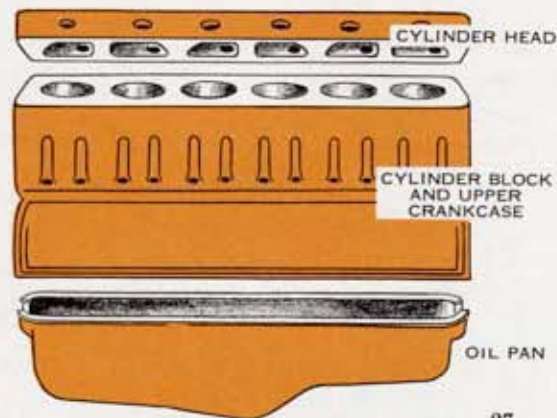

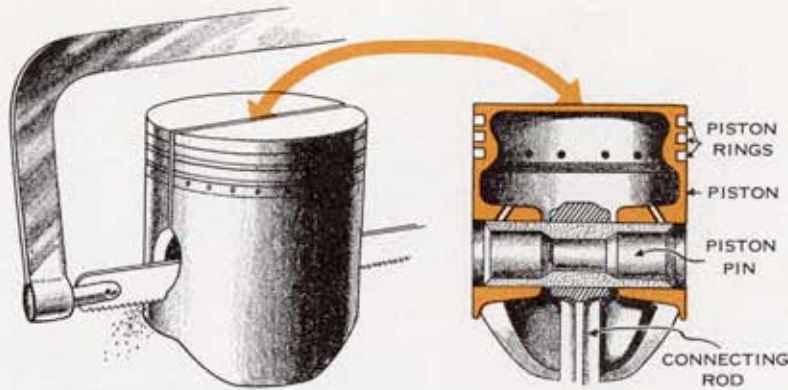

iron (sometimes special alloys approaching the composition of steel) or aluminum. Light weight is important because pistons must travel so fast in modern high-speed engines. A piston must stop and reverse direction at the end of each stroke, and in between stops may reach speeds of 60 miles per hour.

It would be difficult to make a solid piston fit a cylinder accurately enough to form an efficient seal. With the variations in temperature encountered it is practically impossible. So we put **piston rings** in grooves in the piston. These are cast iron rings, split at one point and with enough spring in them so they constantly press against the wall of the cylinder. There are two types. Compression rings are to keep the gas from leaking down past the piston during the compression and power strokes. Oil control rings are to control the amount of oil on the cylinder wall and keep it from leaking up past the piston. There are usually several compression rings and one or more oil control rings on each piston.

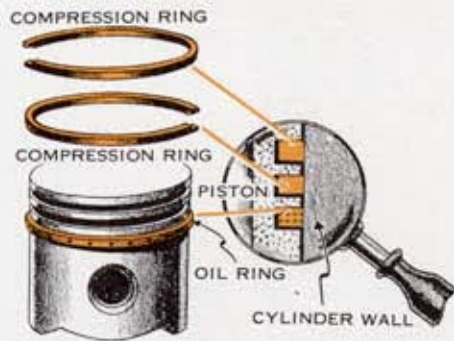

The connecting rod is fastened to the piston by means of the **piston pin** or wrist pin. This is a tubular piece of hardened alloy steel which fits in the small end of the connecting rod. Its ends are fastened in the piston. The big end of the connecting rod has a separate

cap which allows it to be bolted around the crank on the crankshaft. The connecting rod is usually of I-beam section and forged from a steel alloy to keep it as light and strong as possible.

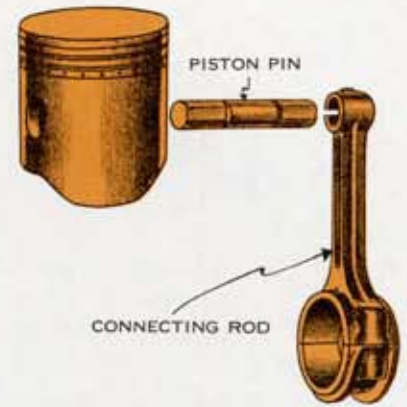

The crankshaft of an in-line engine is a shaft with as many cranks as there are cylinders. We can think of it as that many single-cylinder crankshafts fastened end to end, although it may look somewhat different as there are not always bearings or supports for the shaft between each two throws. It also looks different from our first simple crank because of the counterweights.

It has these weights opposite each crank throw to balance it, so the shaft will run smoothly. Otherwise it would be like trying to spin a lopsided top. The crankshaft is usually a forging of a nickel-steel alloy. There must be no question of its strength and durability, as it is literally the backbone of the engine.

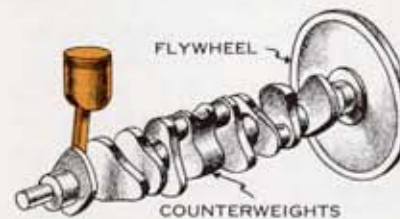

There must be no question of its strength and durability, as it is literally the backbone of the engine.

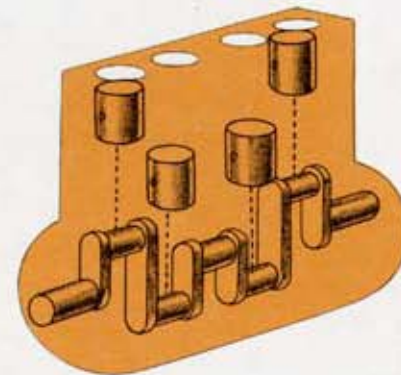





**T**HE fuel system starts with the **gasoline tank**. We must have a supply of fuel in that.

Then we have to get the gasoline from the tank to the carburetor. We ordinarily have only one carburetor for all the cylinders. The **fuel pump** gets the fuel there. It sucks the gasoline through a metal tube from the tank and forces it into the **float chamber** of the carburetor. This is a sort of store room for the fuel. It gets its name from the float in it, which floats on top of the gasoline and closes a valve when the gasoline reaches the proper level. This shuts off the fuel coming from the pump. Whenever the level begins to drop, the float opens the valve and lets more gasoline in.

Next to the float chamber is the carburetor proper. It is essentially a tube, something over an inch in diameter. It is open to the air at the top, with the intake manifold connected at the bottom. Air rushes down this tube at high speed, pulled in by the suction in the engine cylinders—or to be more accurate, pushed in by atmospheric pressure because of the lower pressure

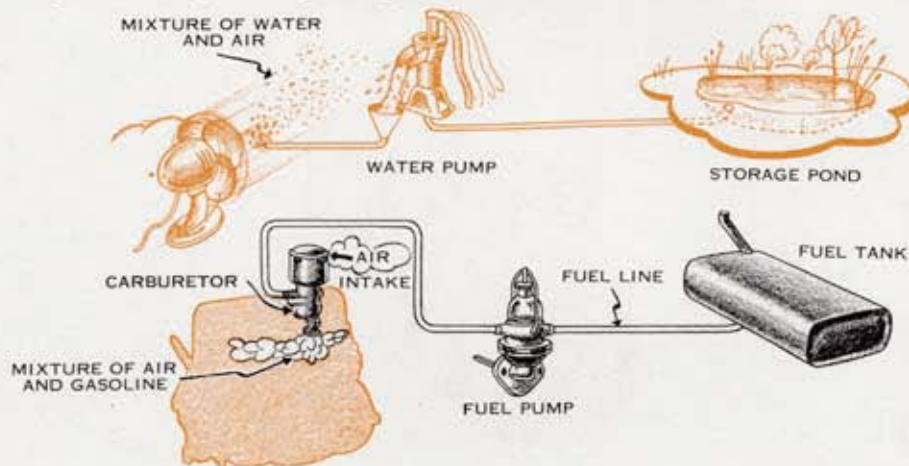

in the cylinders. It sometimes reaches a speed of 250 miles per hour. An **air cleaner** at the top of the tube takes out any dust or grit which might cause wear or injury to engine parts.

At one point the tube narrows down, and then gradually tapers back to its original size. This shape as shown in the illustration is known as a **venturi**. It causes a decrease in air pressure at that particular point.

Into the side of the air tube right at that spot runs a small tube from the float chamber, its end sticking out slightly from the wall. This is almost full of gasoline, the level being the same as the level in the float chamber. As the air rushes by the opening, it sucks out fuel in very small drops and carries them along with it. It is exactly the same as an atomizer with which you

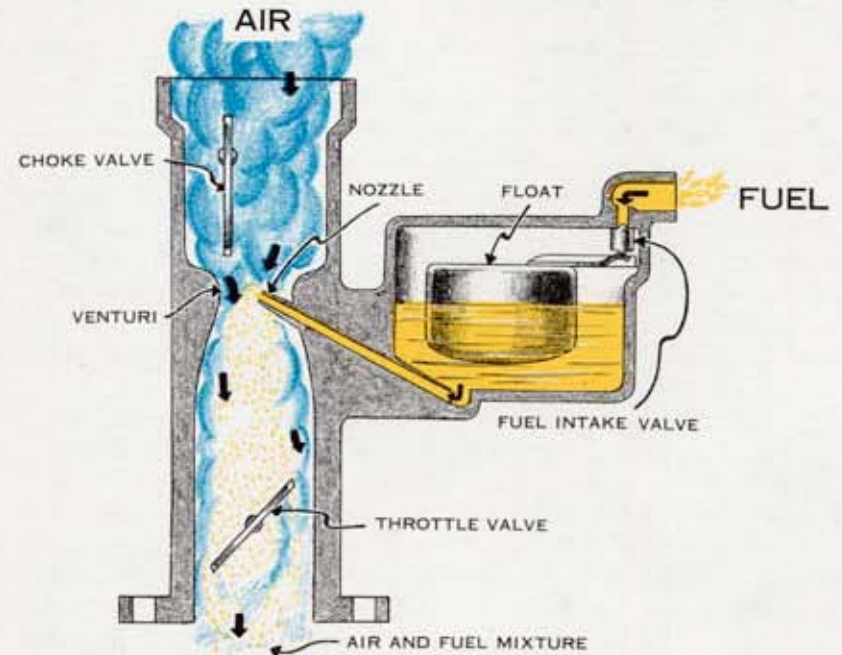
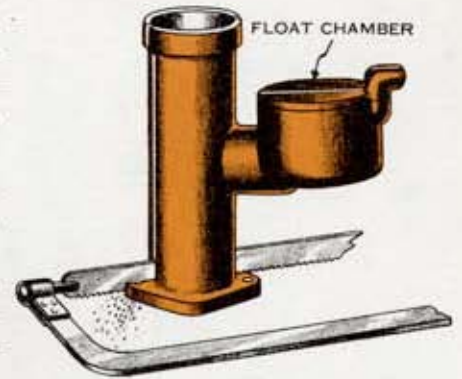

*Part throttle or low power*

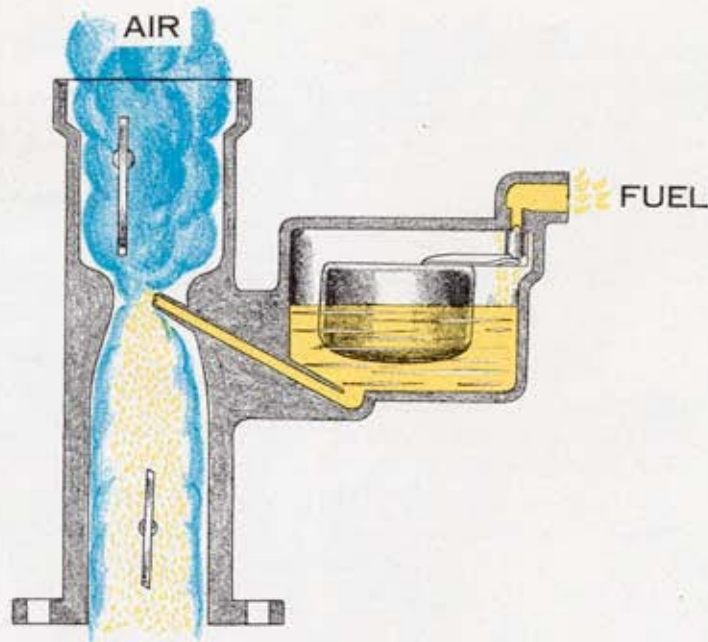

*Full throttle or full power*

spray your throat, or a sprayer for killing bugs in your garden. It might be likened to a gust of wind sucking dry leaves out of the end of a culvert and whirling them along with it.

The speed and power of an engine are determined by the amount of fuel-air mixture taken into the cylinders. This is controlled by the **throttle valve**, which in an automobile is connected to the accelerator pedal in the driver's compartment. The throttle valve is in the lower part of the carburetor, and simply varies the opening of the tube at that point. When it is part way closed, less air and fuel are pulled into the engine.

The carburetor has two jobs. One is to atomize the fuel, that is, to break it up into very tiny particles. This is fairly well done in sucking it out into the tube, and the process continues as it is whirled along in the miniature hurricane.

The second is to meter the fuel, that is, to see that it is mixed with the air in just the proper proportions. This is done primarily by having the proper size opening in the tube from the float chamber to the air tube. The proper proportions are then kept more or less automatically. When the throttle valve is opened

wider, more air is pulled in and also more fuel, and the proportions—the mixture ratio—are kept about the same.

This is a very simplified example of a carburetor. In actual practice they have at least two jets or fuel passages from the float chamber to the carburetor proper. One is for idling and low speeds, the other for higher speeds or harder pulling. There are also various other auxiliary devices built in the carburetor. Most of them are for the purpose of changing the fuel-air ratio to take care of some special condition.

We have explained earlier that theoretically there should be 15 pounds of air to 1 pound of gasoline. We would call that a mixture ratio of 15 to 1. But gasoline will burn with a mixture ratio from about 18 to 1 down to 8 to 1. When there is more air than usual, let us say a ratio of 16 to 1, we call it a "lean" mixture. When it is a low ratio, less than 14 to 1, we call it a "rich" mixture. Sometimes we want temporarily a mixture quite different from the theoretically correct one, such as for sudden acceleration or for the very highest speed. Most of the auxiliary devices on carburetors are to take care of such cases.

One of these deserves mention. When a car has been standing for some time, particularly in cold weather, it will not start with the ordinary mixture. It needs a rich mixture—more fuel in the air. To furnish this we have a **choke valve**. This looks much like the throttle valve, but is located in the tube above the carburetor. When it is partly closed, a high vacuum is formed beneath it. More fuel and less air are pulled in, giving the desired rich mixture. On most automobiles today, this choke valve is controlled automatically and the driver has nothing to do with it.

From the carburetor, the mixture of fuel and air enters the intake manifold. This is a carefully designed pipe with the branches leading to the tops of all the cylinders. When the engine is running the mixture flows into this in a continuous stream.

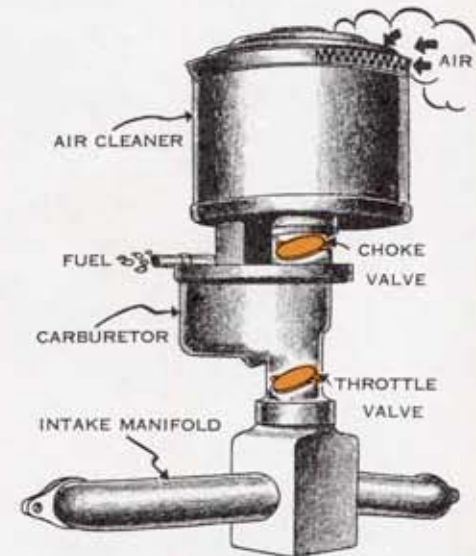

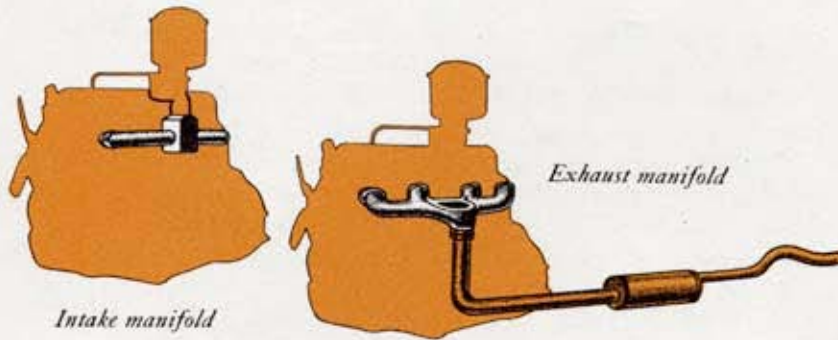

But we do not want it flowing into the cylinders continuously. Each cylinder should be open to the manifold only during its particular intake stroke. It is the intake valves which take care of this.

The same holds true for the exhaust. The exhaust manifold is a pipe quite similar to the intake manifold. This must be open to each cylinder only during its exhaust stroke to allow the hot gases to escape to the open air. The exhaust valves do this job.

Thus each cylinder must have at least one intake valve and one exhaust valve.

Automobile engines ordinarily use poppet valves. These are sometimes called "mushroom" valves, due to their shape. The outside edge of the circular head is cut at an angle, which must be exactly the same as the angle cut in the cylinder head where the two fit together. We do not want any leakage here. The valves are made of special alloy steels to withstand the high temperatures of the combustion chamber. This is especially true of the exhaust valve, as it does not have the benefits of being cooled by the incoming mixture passing over it.



The valves are controlled by the **camshaft**. This is a long straight shaft with knobs or projections on it called **cams**. There is one of these cams for each valve. As the shaft goes around, the **valve lifter** slides on the cam and is pushed up when the high part of the cam reaches it. This in turn

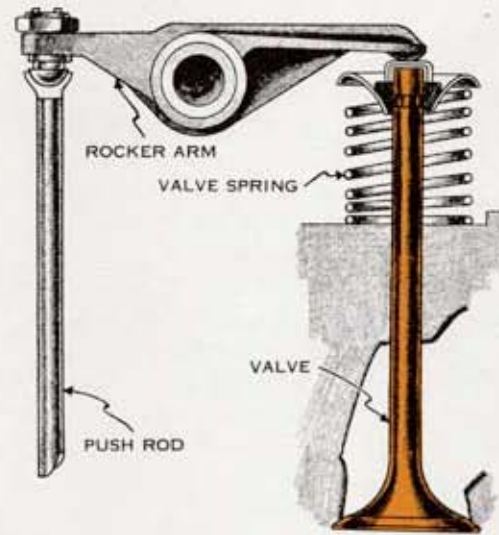

lifts the **push rod** and one end of the **rocker arm**. The other end of the rocker arm moves down, like a teeter-totter, pushing open the valve against the pressure of the coil spring. As the cam goes on around, the spring closes the valve. The cam opens the valve and the spring closes it. A cam is really something like a crankshaft and connecting rod combination; it changes rotary motion to straight line motion.

The camshaft is connected to the crankshaft

by gears or a chain at the front of the engine. Inasmuch as we want each valve to open only once for every two revolutions of the engine, the camshaft goes around at exactly half the speed of the crankshaft.

The camshaft must be made with the cams in just the right places, and it must be connected with the crankshaft in exactly the right way. If these are not correct, the valves will not open and close at the right time in relation to the movement of the piston. The intake valve might open when the piston was going up on the compression stroke

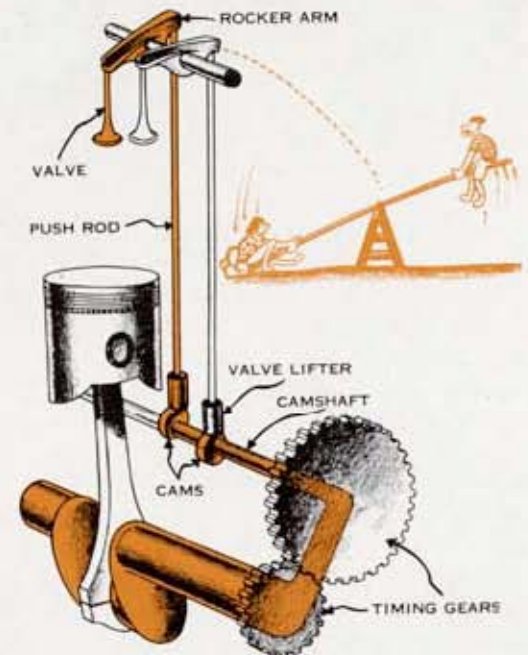

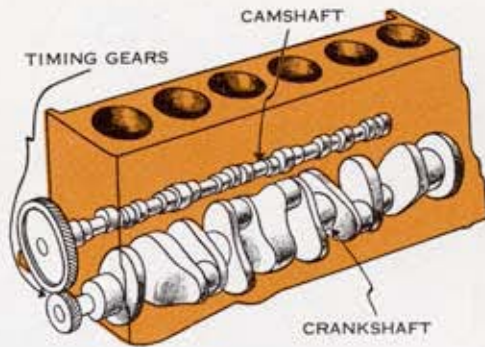

or down on the power stroke. The job of gearing the camshaft to the crankshaft so that the valves will open at just the right time is called timing the valves, and the gears on the two shafts are called **timing gears**.

The engine we have been discussing thus far is called an **overhead valve engine**, or **valve-in-head engine**. The reasons are obvious, as the valves are located in the cylinder head and are operated from above. The other common type of engine, when classifying them

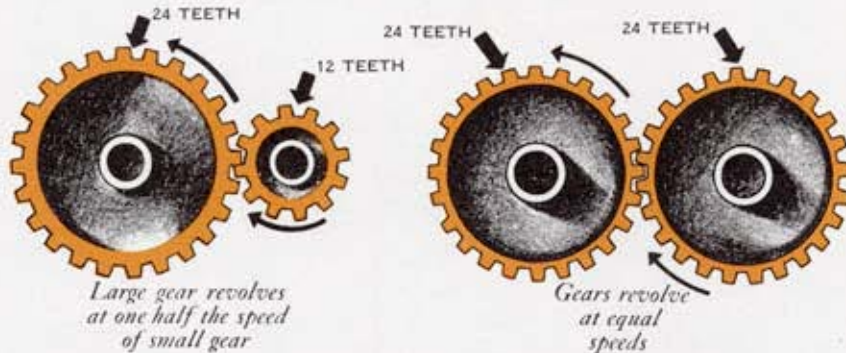

according to valve arrangement, is the **L-head engine**.

In the L-head engine, the combustion chamber is extended to one side beyond the cylinder, forming an upside down L. The valves are turned upside down and fit in ports in the bottom of that extension. They are in the cylinder block instead of in the cylinder head. They move upward to open the ports, and therefore there is no need of rocker arms to reverse the direction of movement. They can be opened directly by the camshaft and valve lifter. They are closed by the coil springs, and in general operate exactly the same as the overhead type.

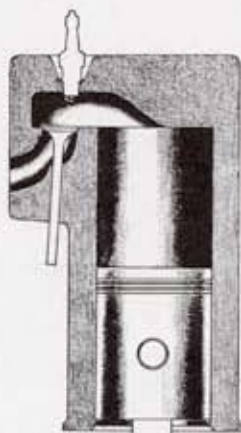

We have already explained that a spark plug ignites the mixture in an automobile type engine. The electricity travels down one electrode and jumps across the gap, or air space, to the other electrode. It jumps across in the form of a spark, which is just like any other kind of fire as far as the inflammable mixture in the cylinder is concerned.

We may wonder why it takes so many pieces of equipment just to make this spark. Suppose we see what the ignition system has to do.

There are two circuits in the ignition system, that is, two complete paths around which the electricity flows. These are the **primary**, or low voltage circuit, and the **secondary**, or high voltage circuit. If we think of electricity as water flowing through a pipe, voltage is the pressure pushing it through. Now it takes quite a bit of pressure to push that electricity across the space between the spark plug electrodes, much more than we have available in an automobile. One of the main jobs of the ignition system is to raise that voltage high enough to make sure that we have a hot, fiery spark in the combustion chamber.

Let us go around the primary circuit first. We will start with the **battery**. The battery supplies the electricity. It is sometimes called a device for changing chemical energy into electrical energy, or a storehouse for electricity. A dry cell, such as a flashlight battery, is much the same thing.

Electricity goes from the battery to the **coil**. It is the coil which raises the voltage. It consists of two coils of wire. The primary, which is connected to the battery, is several hundred turns of comparatively large wire. The secondary, which is wound over the primary but carefully separated, or insulated, from it, may have from 10,000 to 25,000 turns of fine wire, or more than a mile of wire.

As long as an electric current is flowing steadily in the primary circuit, nothing happens in the secondary. But if that

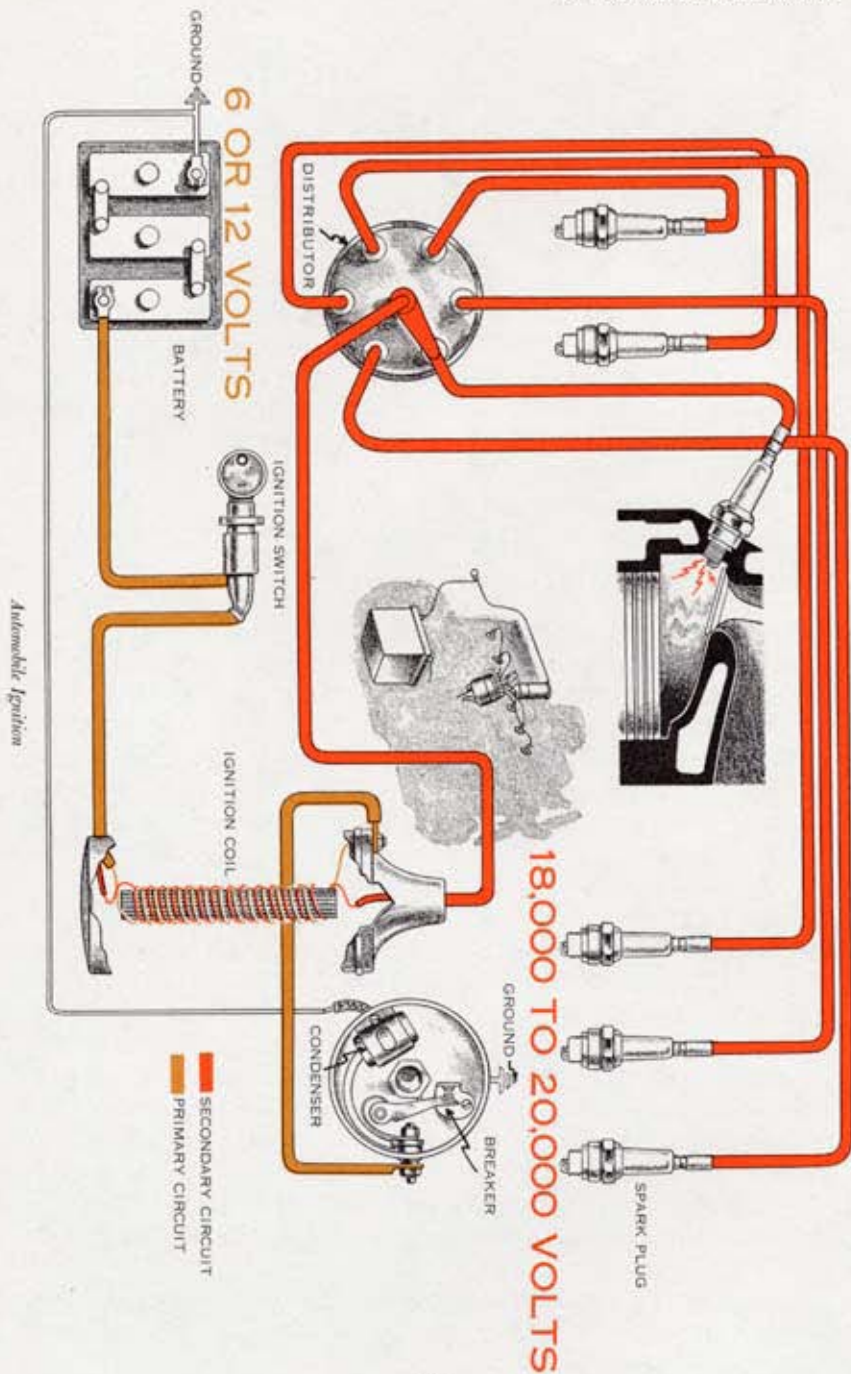

current is suddenly stopped, if the primary circuit is broken, a momentary high voltage is set up in the secondary circuit. This may reach a value of 20,000 to 25,000 volts, as contrasted to the 6 or 12 volts furnished by the battery. We will not go into the scientific reasons for this here, but will take the word of the electrical engineers that this is a fundamental characteristic of electricity.

Now what we need is something to break the primary circuit often enough to send that high voltage to each spark plug just when we want it to fire. So we put a **breaker** in the primary circuit. This is a pair of contacts which are opened and closed rapidly by a cam. The cam ordinarily has as many points as there are cylinders. It is driven from the engine, usually from the camshaft which operates the valves. The contacts are timed to open near the top of each piston's compression stroke. Thus the primary circuit is continually being broken and connected again, which sends a series of high voltage surges through the secondary circuit.

A **condenser** is incorporated in the breaker case. Its principal job is to help give a quick, clean electrical break without sparks when the breaker contact points separate. This is necessary to get a good spark in the combustion chamber.

These are all the parts of the primary circuit. To complete the path for the electricity, a wire is run from the circuit breaker to the frame of the vehicle. One terminal of the battery is always connected to the frame, which acts as a return path for all circuits in the car. This is called the **ground**.

For the secondary circuit we go back to the coil. The high voltage electricity starts there, in the winding of thousands of turns of small wire. To get this to the proper spark plug at the proper time, we have the **distributor**. This is a rotary switch. We might liken it to a clock—a clock with only one hand and with

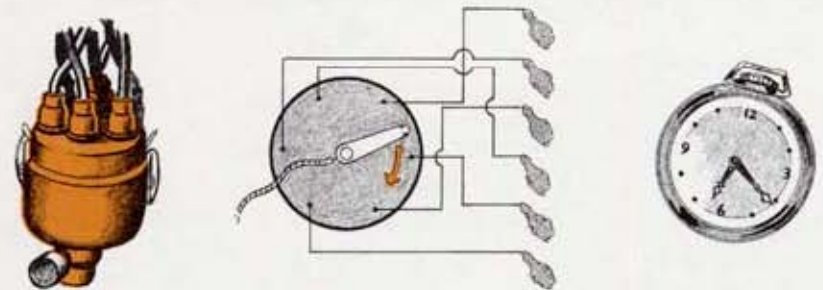

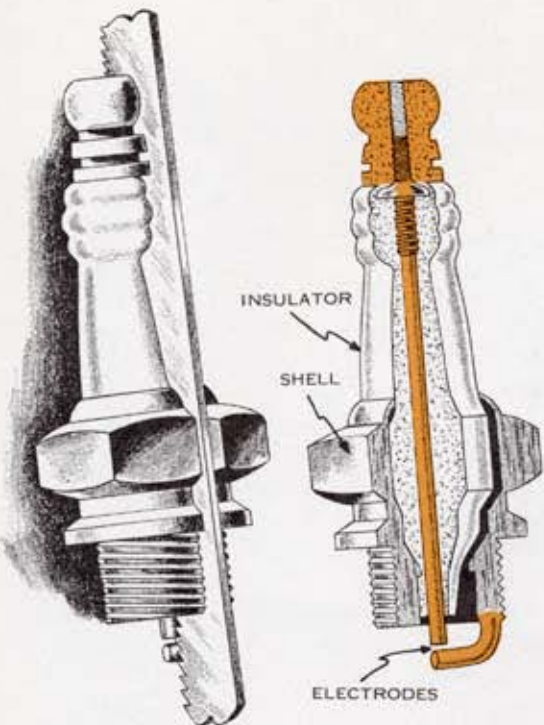

the hours marked in raised numerals which the hand rubs on as it moves around. Instead of the hand going around once an hour, it may go around more than two thousand times a minute. A wire from the coil goes to the center of the distributor, the point where the hand is fastened to the face of the clock. There is also a wire from each contact point—clock numeral—to a spark plug. Thus as the rotor—clock hand—goes around, electricity flows first to one contact point, then to another, and thus to one spark plug after another.

The spark plug itself consists of a steel shell in which is an insulator of porcelain or some similar material. An insulator is a body through which electricity will not flow. Through the center of this insulator runs a wire, or electrode, and another electrode extends out from the bottom of the steel shell to a point close to the center electrode. The shell is screwed into the cylinder head and the wire from the distributor is connected to the top of the center electrode. The electricity flows down and jumps the gap to the other electrode, hence to the engine block and to ground. This completes the secondary circuit and concludes the ignition cycle.

We should correct one false impression we have given. We have discussed the breaker and the distributor as if they were two separate and distinct units. One is in the primary circuit and one in the secondary circuit, and the jobs they have to do are quite different. But in an automobile they are combined in one housing, and the same shaft drives the distributor rotor and the cam which opens the breaker contacts. From the outside it looks like one unit. So when someone speaks of the distributor

of an automobile engine, he is quite likely to mean the whole unit, including the breaker.

So we have all the parts necessary to start the mixture burning in the cylinder. There do not seem to be so many parts when we consider all that the ignition system has to do and the speed at which it must do it. In a six-cylinder engine driving a car at 80 miles an hour, the coil must furnish about 12,000 sparks a minute, or 200 every second. The breaker contacts are closed for less than five thousandths of a second for each spark. On a thousand mile trip these contacts must open and close more than 9,000,000 times. And each of these millions of sparks must occur at exactly the right time and without a miss.

The ignition system has a real job to do. And if it fails—even in one part only—our engine is useless until it is fixed.

### HEAT—Friend and Foe

Heat is the basis of the internal combustion engine. It is the heat content of gasoline which makes it a good fuel. It is heat which causes the expansion which pushes on the piston. Without heat we would have no power. The more heat we have, the more power we have.

But we have not yet learned how to make use of all the heat generated by the burning of the fuel and air. It is hard to measure the temperature in the combustion chamber, but we know that it is momentarily sometimes more than 4500 degrees Fahrenheit. This is about twice the temperature at which iron melts. Therefore if we did nothing to cool it, and the engine kept on running, we would soon have a lumpy mass of molten metal. What would happen in reality is that some part would get hot, swell up and stick, and the engine would stop.

So we put a **cooling system** on the engine. We get rid of the heat fast enough that the metal does not reach those melting temperatures. We simply throw away some of that valuable heat. We have to in order to make the engine keep on running. We throw away another large portion of heat in the exhaust gases, as it is not practical to make use of all the heat in them before letting



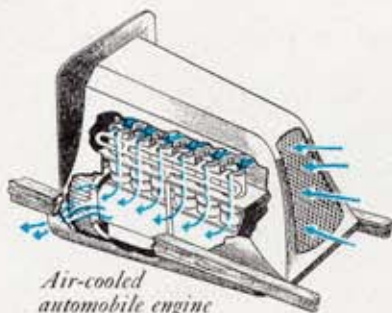

them out into the atmosphere. In throwing away all this heat, we are actually wasting that much of the energy which was in the gasoline. Under the best conditions, an automobile engine uses only a little over a quarter of the energy in a gallon of gasoline. In ordinary driving around town it may be as little as one-tenth. But

even this is better than most other ways of producing power.

Engines can be cooled by blowing air over them. A fairly large fan is used, and baffles are arranged to direct the air to the right places. The cylinders are built separately with air spaces between them, and they have many thin metal fins all over them to help get the heat out of the metal and into the air. Such engines have been used in automobiles in the past, but now water-cooled engines are used generally. We will hear more of air cooling when we get to aircraft engines.

In a water-cooled engine, there are passages built right in the block and cylinder head. These go around the cylinders and combustion chambers, and other places which might get very hot when the engine is running. The passages around the cylinders are called the **water jacket**. A pump circulates water through these passages, where it of course gets hot, and then to the top of the **radiator**. The radiator is to cool the water. As the water flows down through small tubes, air passes through the radiator all around the tubes and cools the water. The water then goes back to the pump and through the engine again. The air is forced through the radiator by the motion of the car and also pulled through by the fan right in back of it.

Thus we see that it is really the air which does the cooling. What we call a water cooling system is simply an indirect air cooling system.

Heat affects engine operation in another way also. Whenever we have two things rubbing against each other, or one turn-

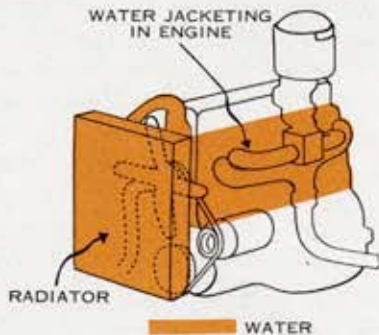

AUTOMOBILE ENGINE

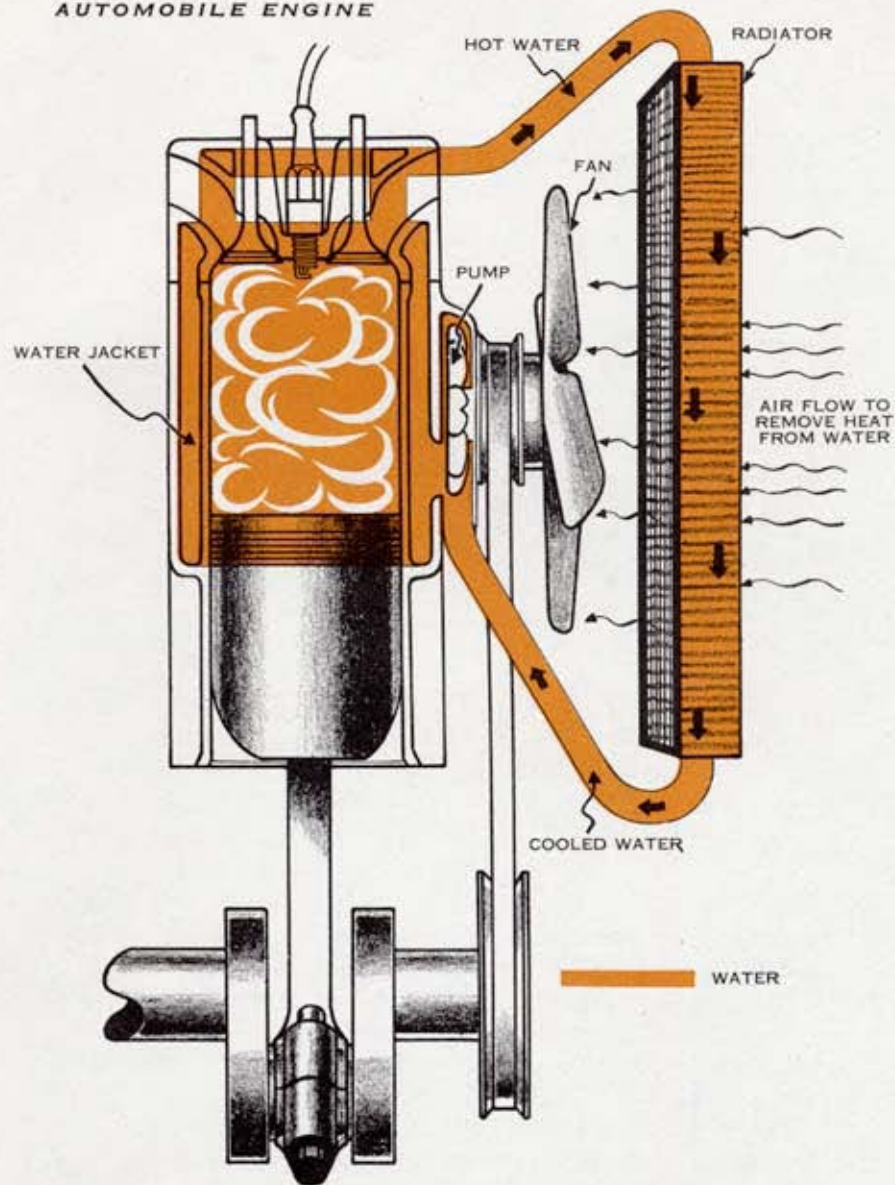

ing inside another, we have friction. And when we have friction we have heat. So we need a **lubrication system** on an engine.

If we can keep oil between two rubbing surfaces, no matter how thin a film of it, the friction is very small. This not only prevents heating up, but makes it easier for the engine to run.

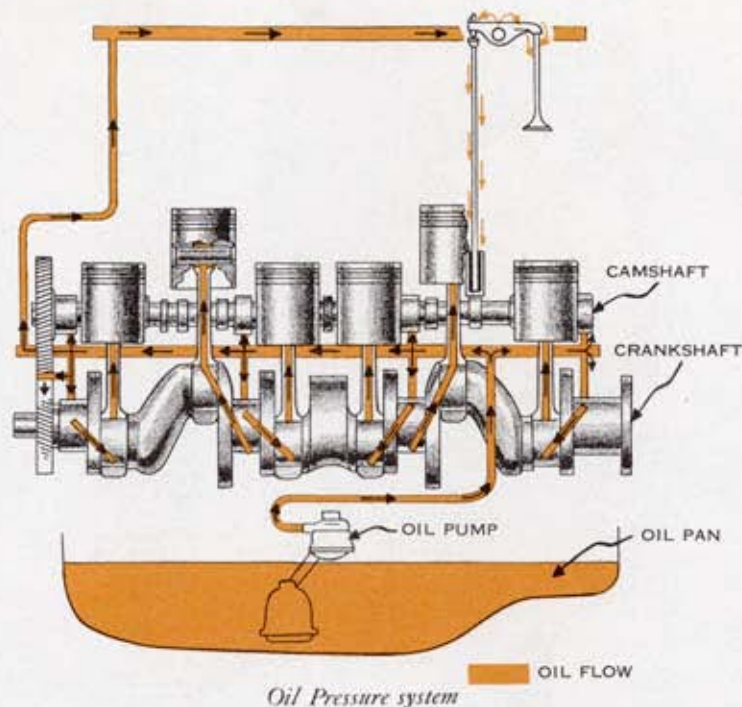

Less power is wasted in moving the engine parts themselves, and thus more is available for useful work at the end of the crankshaft.

It is possible to run an engine without lubrication, but not for long. Almost immediately some part would get hot enough to seize or stick, and the engine would stop, probably with some broken pieces.

The oil is stored in the bottom of the crankcase, or oil pan. From there a pump forces it under pressure to some of the more critical points in the engine, particularly the crankshaft bearings. These **main bearings**, as they are often called, are inserts between the shaft and the members of the crankcase which support it. They are of special metal with good anti-friction qualities. A similar bearing is in the big end of each connecting rod where it goes around the crankshaft.

Usually the oil goes from the main bearings through passages drilled right in the crankshaft to the connecting rod bearings. Sometimes there is a passage the full length of the connecting rod, and the oil, still under pressure, is forced up through it to the piston pin. In some engines, the connecting rod bearings obtain oil by means of a dipper on the bottom of the rod which scoops oil out of a shallow pan.

It is very important that the piston and cylinder wall surfaces receive lubrication. But they do not need it under pressure. They, and many other parts, get their oil by the "splash" system. Oil is thrown off from some of the bearings, and the moving parts of the engine splash oil around. A mist of oil vapor fills the whole inside of the engine. This takes care of those places not included in the pressure system.

We might think of the lubrication system as the water system in our house. Water is forced under pressure to many different points, kitchen sink, wash bowl, and bath tub for example. If for some unknown reason we wanted to get the whole bathroom wet, we might turn on full force the hot water in the shower. The splashing and the steamy vapor would soon have moisture on everything in the room. Thus we would have a pressure system and a splash system just as in the engine.

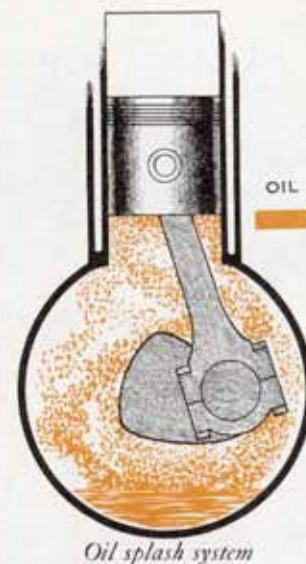

We now have a complete engine. We have not attempted to discuss every part in detail, but we have put together an engine that will run and keep on running.

With proper provision for air, fuel, and ignition we have an



engine that will run. We add cooling and lubrication to make sure that it keeps on running.

This is an automobile engine. It may be used for other purposes, but it is primarily to drive an automobile. But we have other types of engines which it is now time to look into. This will be easier than our consideration of the automobile engine, because we have already covered much of the ground. A large part of what we have explained applies equally well to aircraft and Diesel engines. The fundamentals are the same. The main job will be to point out the differences—what it is that makes one an aircraft engine and another an automobile engine. As before, it will be principally a matter of finding out how each type gets its AIR, FUEL, and IGNITION.

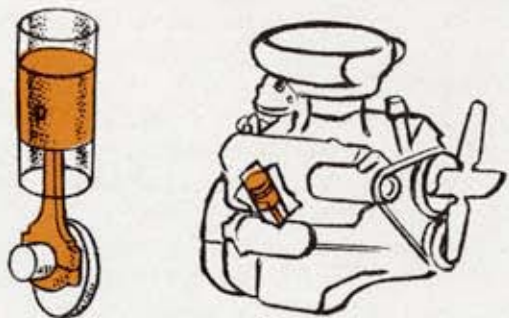

## Aircraft Engine

**P**RACTICALLY all the things which make an aircraft engine different from an automobile engine are the result of one fact—we have a *third dimension* to take into account.

As soon as we leave the ground we have a new set of conditions. And when we get 7 or 8 miles above the earth, where planes are flying today, those new conditions become extreme. The air becomes very thin, the temperatures may be almost 200 degrees colder than when we took off. Those are things which must always be kept in mind in designing an airplane engine.

But long before we have to worry about those extremes, we run into another problem. In an automobile all the engine has to do is move the car along the ground, fast or slow. In an airplane, the engine has to move it forward fast enough to keep it up in the air, and in taking off from the ground it has to furnish the power to lift it up. The plane is fighting gravity all the time.

This makes weight a matter of great importance. Every extra pound built into the plane means a pound less gasoline or pay load which can be carried.

All parts of an airplane are engineered with the idea of making them as light as possible. And the engine is no exception. The aircraft engine builder is constantly trying to produce engines with as much power and as little weight as possible. As the engineer would put it, we want a high power-weight ratio.

Some of the results of this striving for lightness can easily be seen in just looking at an aircraft engine. It shows up in two ways—*materials* and *workmanship*. The lighter metals, aluminum and magnesium, are used

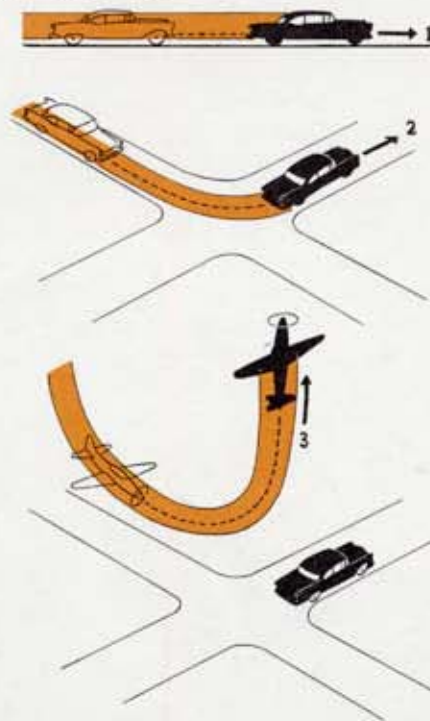

wherever possible, even though it makes the engine cost more. Every part is cut down to be as small and light as it can be made and still do its job efficiently and safely. An ounce of metal in an aircraft engine is doing a lot more work than an ounce of the same metal in an automobile engine. This means it is stressed more—there is more tendency for it to tear apart or break. Therefore the workmanship and finish must be as perfect as modern machines and skilled craftsmen can produce.

It would be possible to build automobile engines in the same way we build aircraft engines. But very few people could afford to buy those automobiles. In airplanes, weight is so important that we are willing to pay a good price for anything which will make them lighter.

Aircraft engines come in many different forms. They vary according to how they are going to be used and what kind of a plane they are going to be used in. Some of the smaller ones may resemble the automobile type engines we have just been talking about. But there are greater differences in the large, powerful aircraft engines, the kind used in the fighters and bombers and commercial transports. And those are the ones we are going to consider here.

Jet engines, of course, are the most different from the engines we have looked at so far. They are internal combustion engines, but they do bring in some new principles. We will take them up shortly, starting with the very fundamentals, but first let's cover the other most important type of aircraft engine. We will briefly describe its mechanical features and then point out how it resembles and differs from the automobile engine in those same three fundamentals—air, fuel and ignition.

This is an air-cooled **radial** engine. To form this engine we take a number of our basic cylinder units, let us say seven, and

spread them out radially around a center. A radial engine is like a large wagon wheel, with the cylinders for spokes and the crankshaft for the axle. It is backward from the usual wagon wheel however, for the spokes stand still and the axle goes around.

There is only one crank, or throw, to the crankshaft of a radial engine. It is just like a single-cylinder crankshaft. It has two large counterweights for balancing. The seven connecting rods must be fastened to it in some way, but there is not enough room to do it in the usual manner. So we have what is called a **master rod**. This has its small end fastened to one of the pistons and its big end around the crank pin just as if it were a single-cylinder engine. The big end is enlarged, however and has pins spaced around it to which are fastened the **link**, or **articulated connecting rods** from the other pistons. Thus the power from all the cylinders is really transmitted first to the master rod and from there to the crankshaft. But for all practical purposes it is just the same as if each connecting rod were fastened directly to the crankshaft.

In a radial engine the crankcase is somewhat like a wide hoop or ring. It has holes around it into which the individual cylinder barrels fit. On top of each cylinder barrel fits its head, which includes the valves. This is an overhead valve mechanism, with the valves set at an angle

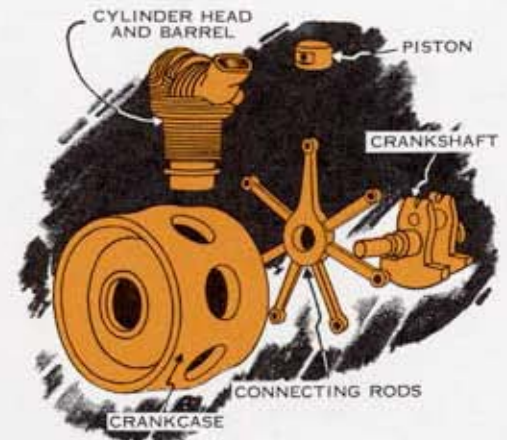
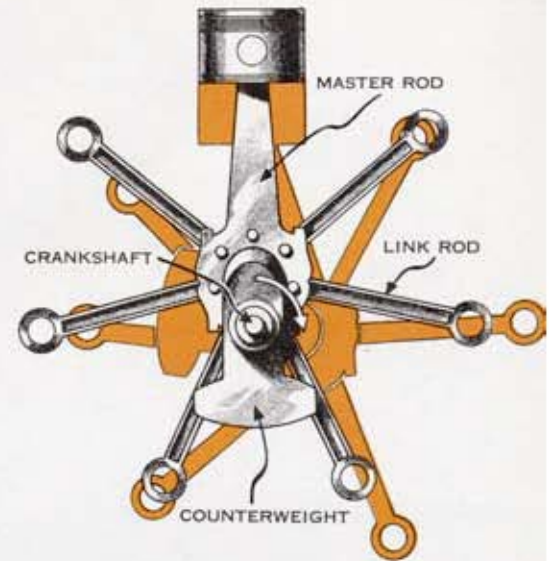

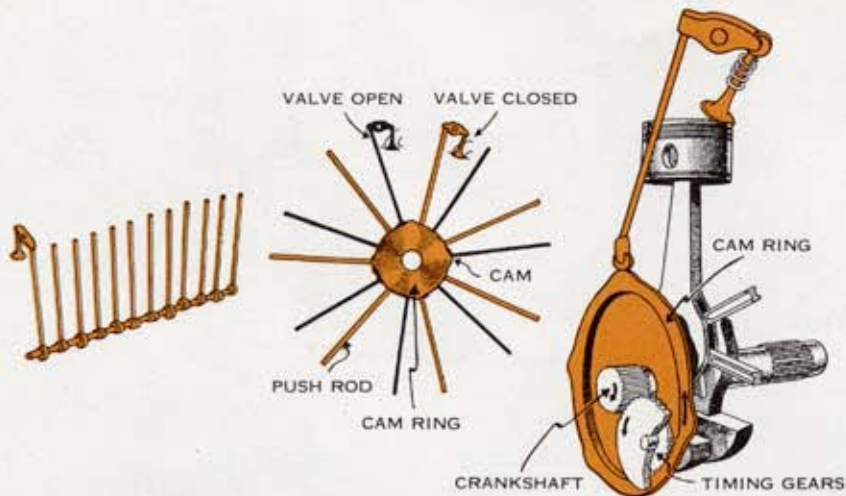

*An automobile type*

*Radial aircraft type*

making a peaked roof on the combustion chamber. There are rocker arms and push rods just like an automobile engine. But the cams are on a ring or round plate instead of on a shaft. There are two cam tracks, one for the intake valves and one for the exhaust valves. As the ring goes around, the cam opens one valve after another. There are usually several cams on each track, which simply means that the ring goes around that much more slowly.

We have said this is an air-cooled engine. One of the main reasons for arranging cylinders radially is to get them all out in the open where the cooling air can pass over and around them,

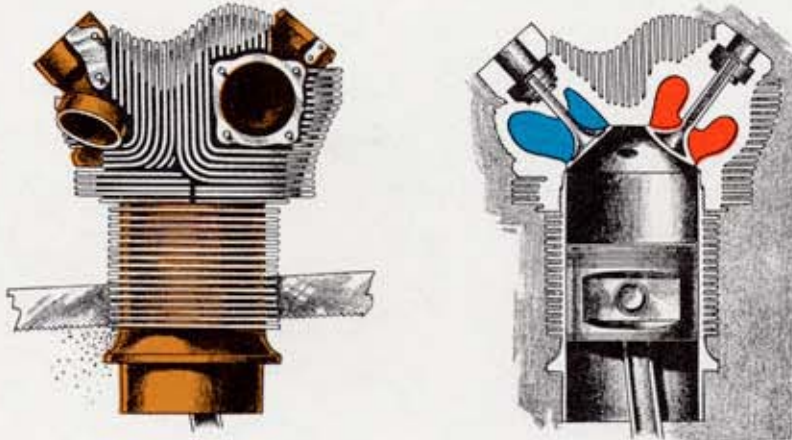

and where they will all get equal amounts of air. With an in-line engine, it is not so easy to get an even flow of air to all the cylinders. There are fins around the cylinder and on the head to give as much cooling surface as possible for the air to reach. At some particularly hot spots, such as around the exhaust valves, more fins are provided than in other places. It is easier to cool an airplane engine by air than it is an automobile engine. It is practically always moving through the air at high speeds, it does little running with the vehicle stationary, and it gets the added benefit of the air being blown back over it by the propeller.

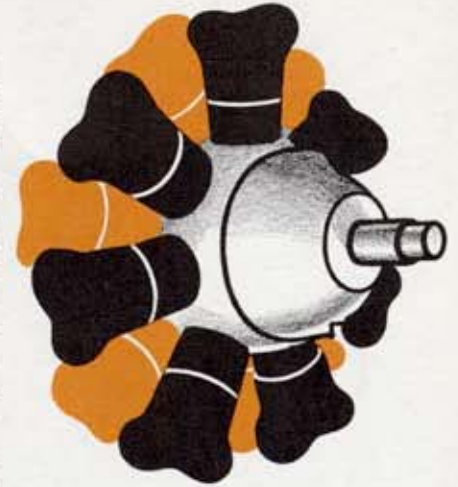

Some radial engines have more than one bank of cylinders. That is, there is one row of cylinders, right in back of this another row, and sometimes still more in back of these. They are staggered, so that the back cylinders are in the spaces between the front ones and thus receive enough air for cooling. It is almost the same as putting two or more complete engines together, just as we add cylinders to an in-line engine.

Another variation of the radial engine is the **compound** type. When the exhaust valves open, the gases are hot and still expanding and contain considerable energy. Instead of wasting this energy by exhausting the gases to the open air, in the compound engine the exhaust is led to several small turbines located behind the cylinders. These turbines are geared to the engine crankshaft, so as they are rotated by the exhaust gases passing through them

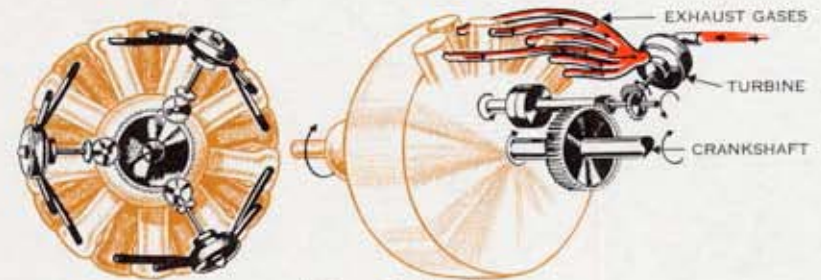

*Turbo-compound engine*

they furnish additional power for the propeller. Such an arrangement adds weight and complication of course, but it increases the power with practically no additional expense of operation.

The lubrication system for the radial engine differs little from those in automobiles. A pump forces oil under pressure to such points as the main bearings, connecting rod bearings, etc. The piston pins and cylinder walls get their oil from the "splash" from the other points. The main difference is that instead of carrying the oil supply in the crankcase, it is stored in a separate chamber outside the engine. In addition to the usual pressure pump, one or more scavenging pumps is provided to return the oil to the storage chamber from the engine. There is also usually a radiator to keep the oil from reaching too high a temperature.



The more air and fuel we can get into the cylinders, the more power we will get from the engine. There is no trouble in getting plenty of fuel in, so if we want to get the most power from an engine of a certain size and weight, our main problem is to see that it gets as much air as it can handle.

With aircraft engines we are always trying to get more power without making the engine bigger. So we use special means to get more air and fuel into the engine. Instead of depending on the pressure of the atmosphere to push the mixture into the cylinder, we blow it in. We add to the engine a supercharger, sometimes called a blower.

All the large aircraft engines have a supercharger. It is a form of air pump or fan built right in the engine at the rear end and driven from the crankshaft. It is geared to run at very high speeds. The mixture of fuel and air comes in at the

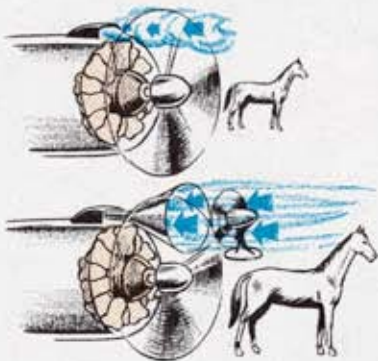

## AIRCRAFT ENGINE

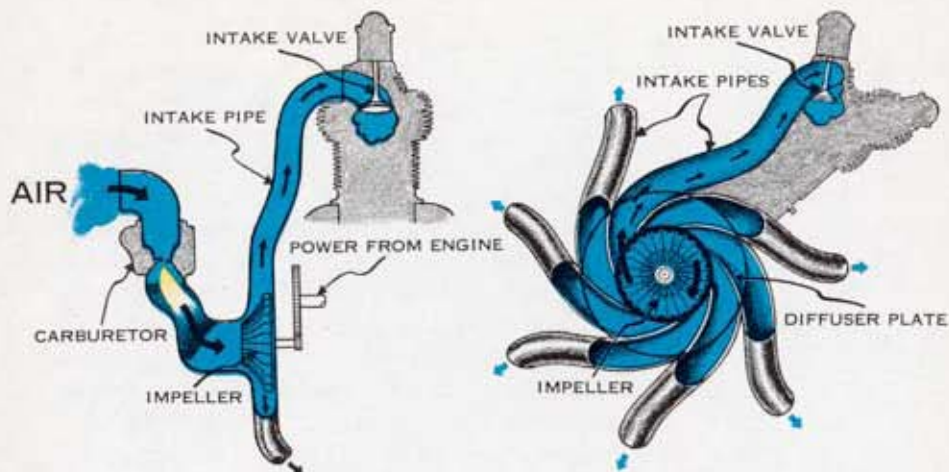

center, is spun around by the blades of the fast moving **impeller**, and thrown outward by centrifugal force. It is gathered in a passage or chamber around the outside of the impeller, where it is slowed down and thus its pressure is increased. From there it flows into the intake manifolds.

We might compare the impeller to a vacuum cleaner fan. The latter sucks air in from the atmosphere, forces it through the cleaner and into the bag. The pressure inside the bag is higher than outside, as we can easily tell by squeezing it or by just watching it expand against the outside pressure.

In the same way the pressure in the manifold has been raised by the supercharger. In taking off at sea level this pressure may be 20 pounds per square inch instead of the 14.7 pounds per square inch of the atmosphere. This much increase in pressure—this **boost**, as it is often called—squeezes more mixture into the cylinders and gives us about 40 percent more power from the same engine.

This is not quite as much clear profit as it may seem. We pay for it in two ways. First, it takes power to drive the supercharger, and this

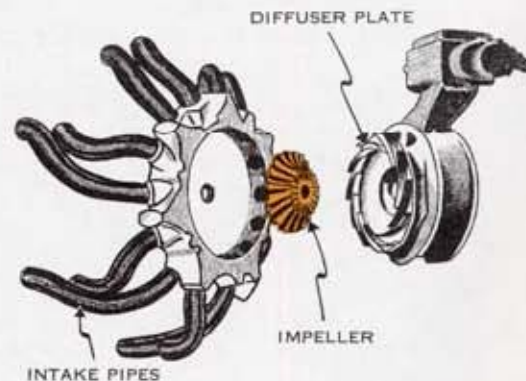

power must come from the engine. In order to get that 40 percent increase in useful power, the actual power of the engine must be increased over 50 percent. The difference goes to drive the blower. Second, we have added weight. The supercharger weighs something, and the engine must be heavier. All the parts of the engine must be made strong enough to handle that greater power. We cannot take an engine designed for 800 horsepower and expect it to stand up under 1200 horsepower. But even with these limitations, we can get more power with less weight by adding a supercharger than we can by simply making the engine bigger.

We have another problem when we add a supercharger. This is detonation. The effect of a supercharger is much the same as raising the compression ratio of the engine. Compressing the mixture in the supercharger makes it hotter. There is more mixture in the cylinder so it will be squeezed harder by the piston. Therefore if we are not careful, we will have severe knocking. We must not raise the pressure too much with the supercharger. That is why high octane gasoline is so valuable in aviation. By its use we can cut down the tendency to knock, and thus we can run the supercharger at a higher pressure. And this, of course, means more power from the engine.

What we have been talking about so far is sometimes called **sea-level supercharging**. The blower is built-in as part of the engine, and its object is to make that engine deliver more power at all times, to act just as if it were a larger engine. It is the same kind of supercharging sometimes used on racing cars. But there is also **altitude supercharging**. An altitude supercharger is what we use to try to make an engine deliver as much power when it is several miles up in the air as it delivers when it is on the ground.

We mentioned early in this book that the air all around us is much like a body of water. The deeper we get in it, the greater its pressure is. Or we can look at it the other way, and say that the higher up we go in this body of air, the less the pressure is. At the bottom—at sea level—this air is pushing against us with a pressure of 14.7 pounds on every square inch. As we go up this becomes less and less, until at 30,000 feet it is only about  $\frac{1}{3}$  as much—less than 5 pounds per square inch.

Another way to look at it is to simply say that the air is thinner when we get up high. It is not being squeezed so much by the weight of the air above it, so it spreads out, or as we usually say, its density decreases. The same amount of air takes

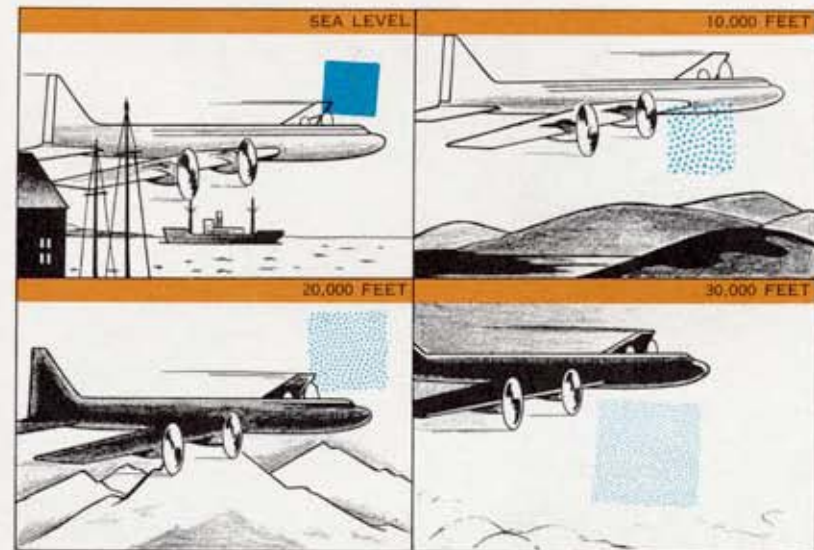

*Squares represent space occupied by equal weights of air*

up more space. At 30,000 feet a cubic foot contains about  $\frac{1}{3}$  the weight of air that it does on the ground.

Considering these things, it is easy to see that an engine without a supercharger would not be much good at extremely high altitudes. We have much less pressure to push the mixture into the cylinder. And even if we could get as many cubic feet in, the air is thin and does not weigh nearly as much. And the weight is what counts. So the result is that the power falls off quite rapidly as the plane climbs—in about the same proportion that the air density decreases. (Actually it falls off a little faster due to other factors.) Thus at 30,000 feet an engine would have less than  $\frac{1}{3}$  the power to drive the propeller that it had on the ground.

We have exactly the same situation when we consider the pilot. He needs a certain weight of oxygen going into his lungs at all times. When he gets up where the air is thin, he can't breathe in as much and what he gets doesn't have the same weight of oxygen in it. He would soon be less efficient than the engine. So what he does is get his from a bottle. He carries along his own supply of oxygen and uses enough of that to make up for what he is not getting from the atmosphere.

What we need for the engine is something to take that thin air and squeeze it together, to make it more like the air on the

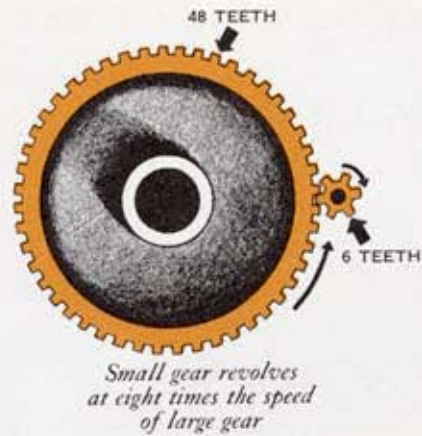

ground. We can use a supercharger which is exactly the same mechanically as the sea level supercharger. In fact one arrangement is to take that same sea level supercharger and simply make it run faster. We can change the gears so that instead of going around about 6 times as fast as the engine, it goes 8 or 10 times as fast. This compresses the air more, so that at medium altitudes we are getting enough

air in the engine to give it good performance.

But we cannot do it that easily. If we simply let the blower run uncontrolled at that high speed, it would furnish entirely too much air when we were near the ground. The engine would be over-supercharged. It would be trying to deliver much more power than it was designed for, and it could not stand up under it. So we have to add controls to prevent opening the throttle wide at low levels—something to cut down the amount of air furnished by the supercharger. These controls can be gradually relaxed as the plane climbs until finally the throttle valve is wide open. The full capacity of the supercharger is then being used, but because the air is thinner we do not get too much air for the engine. At this point the engine is developing its maximum power, and from here up the power steadily falls off as the air gets thinner and thinner.

There are disadvantages to this arrangement. It takes more power to run the supercharger at those higher speeds, and it takes this power even at low altitudes where we cannot use all the supercharging. We are just throwing away some of that power. And there are other losses due to the throttling of the supercharger which take away more of the useful power of the engine. The result is that an engine with an altitude supercharger of this type shows up very poorly at low altitudes compared to the same engine with only a sea level supercharger. A 1000 horsepower sea level engine may have less than 800 horsepower available for take-off when changed to an altitude engine. But the altitude engine will be much better than the other at all points above a certain minimum altitude.

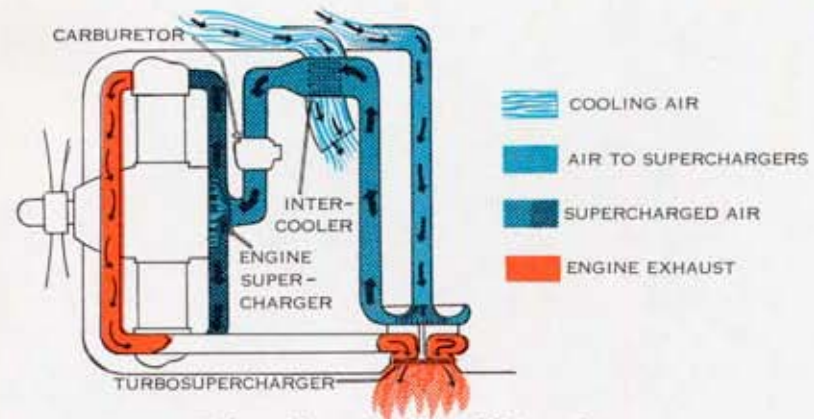

*Turbosupercharger installation with intercooler*

There have been various ways tried to overcome some of these disadvantages. Sometimes two sets of gears are used. One drives the impeller at low speed, the other at higher speed, with means for shifting from one to the other. Another plan is to leave the sea level supercharger undisturbed, and add another separate one called an auxiliary supercharger, which can be brought into operation when necessary. This is called **two-stage supercharging**.

A refinement on this latter system is the **turbosupercharger**, in which the auxiliary supercharger is driven by the engine exhaust gases. This makes possible a simple speed control to vary the boost as needed.

All of these arrangements give better engine performance than the simple single stage type. On the other hand they all add weight, complication and bulk. What type is used is a matter of compromise, depending on what we want the plane to do. We can take exactly the same engine and get entirely different results according to what kind of supercharging we add to it. The same engine can be—and is—used in planes designed to operate under 5000 feet and in planes for stratosphere flying. The cylinder and piston don't even know the difference as long as they get the air they need.



The fuel system of an aircraft engine is essentially the same as that of an automobile type engine. But there is more of it.

We have a greater variety of things to take care of. An airplane engine has to keep on running whether it is right side up, upside down, or halfway in between. The plane may be climbing steeply at comparatively low speed, or it may be in a vertical dive at a terrifically high speed. It has to take off from the ground and it may have to fly at 7 or 8 miles above the ground. Temperatures may vary in a few minutes from 60 degrees below zero to 130 degrees above. And we have to take special precautions against any possible failure of the fuel supply. In an automobile when the engine does not get fuel it means pulling to the side of the road or perhaps blocking traffic; in an airplane it may mean the lives of the pilot and everyone in the plane.

So in an airplane fuel system we have a number of extra things such as vapor eliminators, strainers, auxiliary hand pumps or electric pumps, and quite a variety of devices in the carburetor itself for regulating the mixture of fuel and air according to the particular conditions of the moment.

But it all adds up to the same result we had in the automobile engine. We have a tank containing gasoline, a pump to get the gasoline to the carburetor, and a carburetor to break up the liquid fuel into tiny drops and mix it with the air in just the amounts we want.

In some small airplanes the fuel system and carburetor would look very much like what we have already seen earlier. But we are considering mainly the large engines, so let us see what differences we find there. We will skip the details, and point out only the high spots.

There are several fuel tanks, in

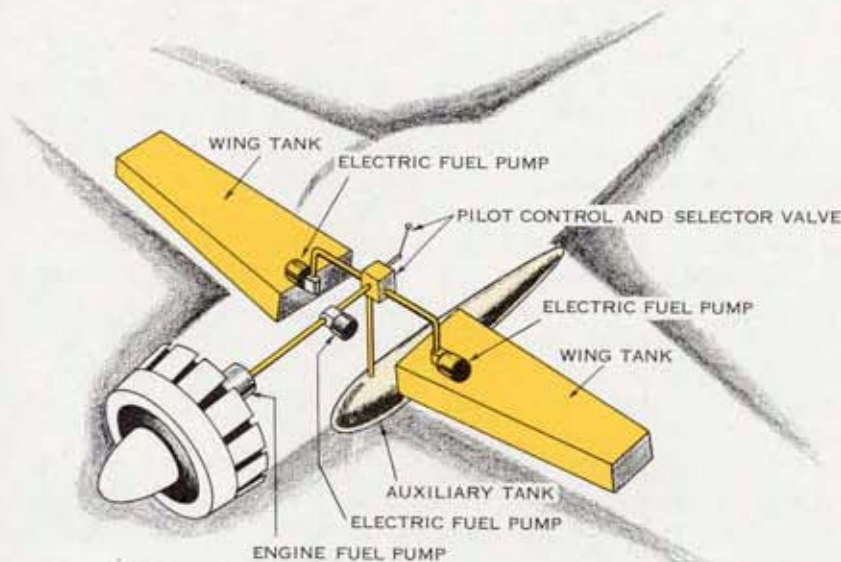

the wings and perhaps in the fuselage, with valves for selecting one or more at a time. A fuel pump driven by the engine draws gasoline from the tank and forces it to the carburetor. It pushes it at a higher pressure than do those in automobiles. In addition there is an electric pump in each tank, which operates continually as a booster pump and vapor separator, and also acts as an emergency pump if anything happens to the main pump.

The carburetor will probably be of the **injection** type. This should not be confused with a fuel injection system, where the fuel is shot into the cylinder separately from the air. It is a carburetor, but it does have some differences from the one we discussed previously. It looks different; it looks like a big box stuck on the back of the engine, with knobs and pipes and such things protruding from it. But inside of it we find an air tube which looks familiar. It has the same shape as in the automobile carburetor and there is a throttle valve near the bottom.

The air comes down this tube, drawn in by the supercharger, but it does not suck the gasoline out of a small pipe into the air stream. Instead we have two small tubes sticking out into the air stream, one above the venturi where the pressure is normal, the other right at the venturi where the pressure is less. These two tubes go to opposite sides of a diaphragm, the difference in the

two pressures determining its position. In turn the position of the diaphragm serves to control a fuel valve in a separate part of the carburetor. It is this fuel valve which permits more or less gasoline to get to the engine, depending on the amount of air flowing through the large air tube. Pressure from the regular fuel pump forces the gasoline through this valve, and injects it from a nozzle below the throttle, right at the entrance to the supercharger. The nozzle breaks it into a fine spray. Thus the fuel is injected into the intake system under pressure, and is not mixed with the air inside the carburetor proper. But the amount of fuel is still determined by the amount of air flowing through the carburetor. And this in turn is controlled by the position of the throttle valve. So the carburetor is actually doing the same things it does in the automobile, but in a different way.

As we can see, the fuel is injected just in front of the impeller of the supercharger. The supercharger helps considerably in breaking up the fuel and making the mixture a fine mist of vapor rather than a stream of air with little drops of liquid in it. This

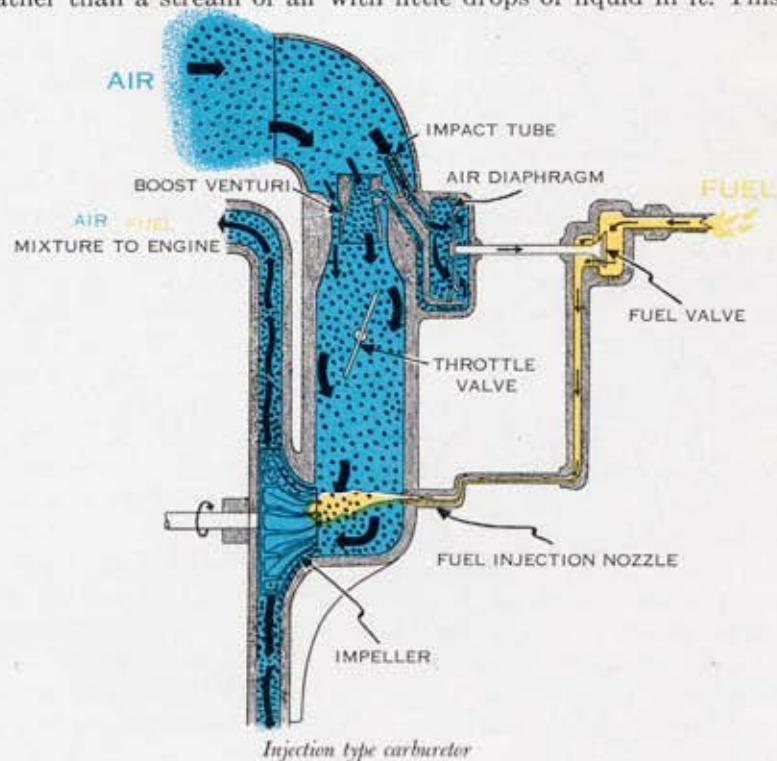

makes it easier to get equal amounts into each cylinder. When we have two stage supercharging, the carburetor may be in either of two places. It may be in front of the first stage, so that both superchargers are handling the fuel-air mixture, or it may be between the two superchargers, so that the first stage is handling just air and the second stage has the fuel-air mixture going through it.

All of the preceding description is of a very much simplified fuel and carburetion system, just as we said it was going to be. In fact a dyed-in-the-wool carburetor man might say it was so simplified that it would not work, and he would probably be right. But it does give the main fundamentals of a rather complicated mechanism.

The subject would not be complete without a mention of the fuel itself. We have told about the benefits of high octane gasoline, and what it has meant to the automobile over a period of years. But it means even more to an airplane. For best results an automobile engine must be designed for gasoline of a certain anti-knock quality. This is also partly true for airplanes. But with many aircraft engines, if we use higher octane gasoline we can give them more boost with the supercharger without damage to them. This means that we can get more power from them, particularly at take-off. Detonation is the main thing holding down the power of most supercharged engines, so we have been able to take immediate advantage of the rapid progress in the production of high-octane fuels by the petroleum industry.



The mixture of fuel and air in an aircraft cylinder is ignited the same way as in an automobile engine. There is a source of electricity at low voltage, a coil to step it up to high voltage, a distributor to send it to the proper cylinder at the proper time, and a spark plug to furnish a spark to start the charge burning.

Let us see what some of the differences are. Two stand out



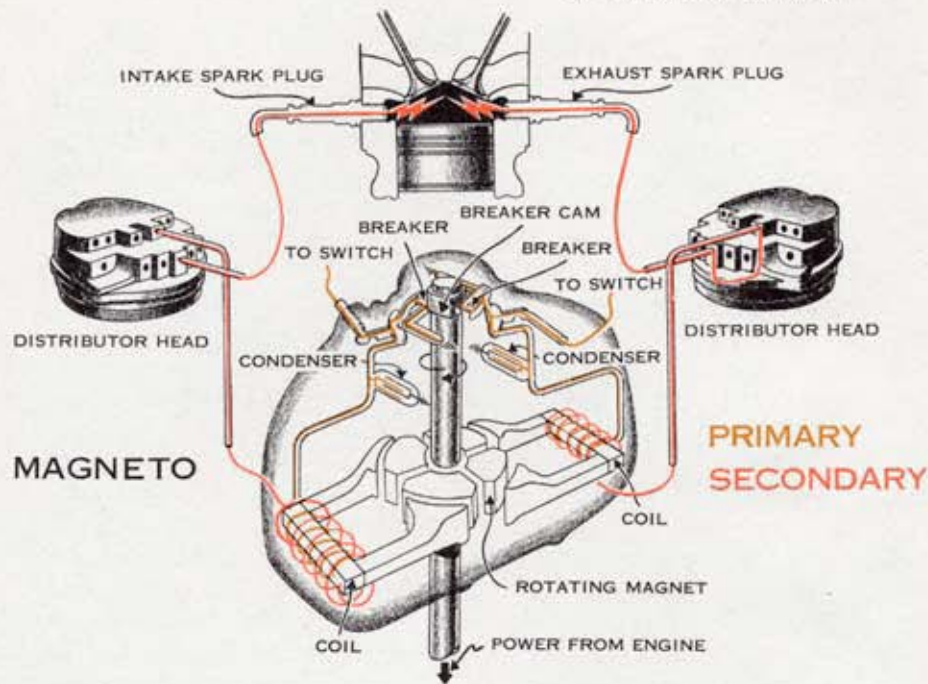

right away, one at the beginning and one at the end of the system. First, there is no battery in the ignition system—we make our electricity as we need it. Second, we find in the cylinder head not one spark plug, but two. This not only helps in getting proper combustion but is also a sort of insurance policy against possible failures.

Instead of a battery we have a **magneto**. Its main job is to supply a current in the primary circuit just as the battery did in the ignition system we discussed before. It is usually built as a unit, however, including in one box the source of current, the breaker, the coil or coils, and sometimes the distributor.

A dual magneto may be used, and another common arrangement is to have two single magnetos, each with its own drive. A distributor is included in the same casing with each one. Thus we have two entirely separate systems.

We might guess that a "magneto" had something to do with a "magnet." And we would be right. What we use may not look like the little horseshoe magnet we used to play with, but it is about the same thing. This permanent magnet spins around between two iron shoes which are part of the core on which the

coil is wound. We will not go into the magnetic and electrical phenomena involved. We will simply say that at certain points in the rotation of the magnet it causes an electric current to flow in the primary coil. Now if the breaker in the primary circuit opens at just that time, the same thing will happen that happened in the battery ignition system—we will get a high voltage in the secondary coil.

The rest is just about the same as the automobile ignition system, except that there are two of everything. The high voltage goes to the center of the distributor, where the rotor directs it to one spark plug after another. One distributor takes care of all the spark plugs on the side of the combustion chamber next to the intake valve, and the other distributor fires those plugs next to the exhaust valve.

The spark plugs may look somewhat different from the automobile type, but they are exactly the same in operation. They have a harder job to do, due to higher pressures and quicker temperature changes. This leads to some differences, such as stronger materials for the insulators. Their appearance is also changed by the metal shield around them to prevent interference with the radio.

## JET Engine

A jet engine is definitely different from the other engines we discuss in this booklet. It brings in some principles we haven't covered, and for that reason we are considering it separately and are going to start from the very fundamentals of the subject. But with all its differences we should remember that it is still an internal combustion engine, and is still completely dependent on air, fuel and ignition to make it go.

Suppose we consider first a toy balloon. We know what happens when we blow one up and then suddenly let go of the stem. The air rushes out and the balloon darts all over the place for an instant. It seems to be going in all directions at once, but actually it is always traveling in a direction opposite to the jet of air blowing out the stem. This is definitely jet propulsion.

A glance at the two diagrams will give an idea of what makes the balloon move. When the stem is closed, the air inside the balloon is under pressure and



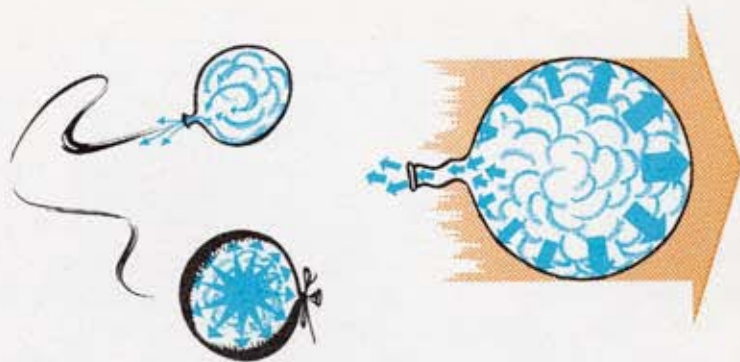

is pushing out in all directions trying to expand. It is pushing in all directions with equal force, so there is nothing to make the balloon move. But when we release the stem, there is less force pushing on that side of the balloon than on the other. So the larger force moves the balloon in the direction opposite to the stem as long as any air is compressed inside.

If we had any way of creating a supply of air under pressure, the balloon would continue to move. And that is exactly what we do in a jet plane. Air comes in the front end and is compressed; burning fuel heats it up and causes it to expand, forcing a jet of hot gases out the back end at very high speed.

Let us clear up one point right here on which many people have the wrong idea. The jet of hot gases does *not* push on the air—the atmosphere—behind the plane, and thus push the plane forward. The jet does not push on anything outside the plane. All the work is done within the engine, in the same way that the forces inside the balloon made it move. In a vacuum our balloon would move even faster. There is an old law of physics which states, "For every action there is an equal and opposite reaction." A great force is required to push the jet out the back of



- OUTSIDE AIR TAKEN IN FRONT
- OUTSIDE AIR IS COMPRESSED
- BURNING FUEL CAUSES COMPRESSED AIR TO EXPAND
- HOT GASES RUSH OUT THE REAR

the plane at high speed, and it is the reaction to that force which pushes the plane forward.

It might make it clearer if we think of a man diving from the end of a canoe. When he jumps forward the canoe moves backward. It moves backward due to the reaction to the movement of the man. And if the man jumps at a faster rate of speed, or a larger man jumps at the same rate of speed, the canoe moves farther. This is because of another law we find in the textbooks: *Force equals mass times acceleration, F = MA*. In a jet

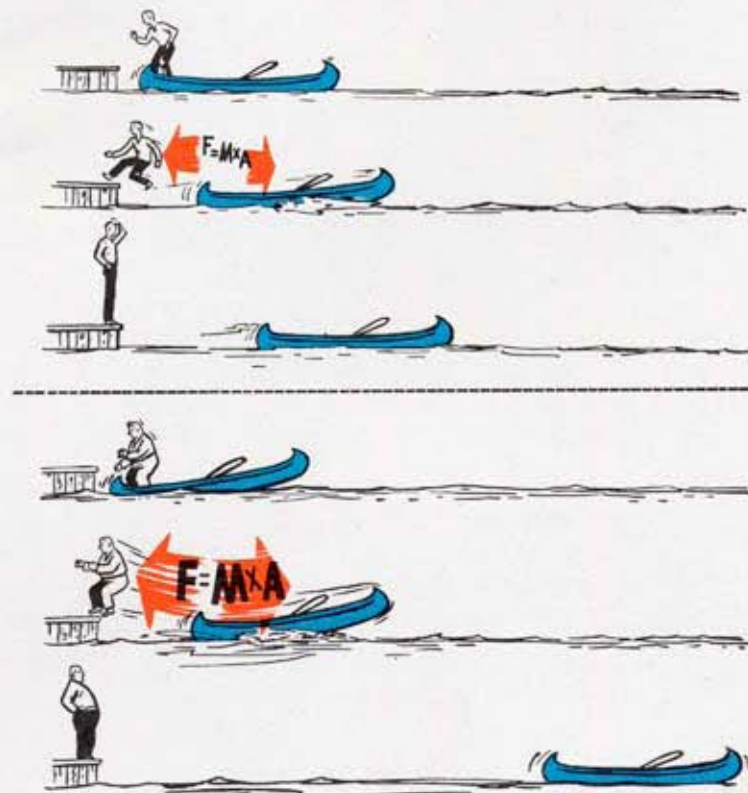
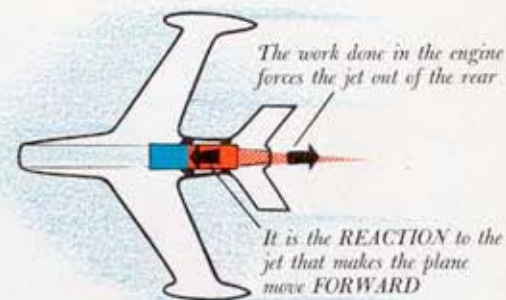

plane this means that the greater the mass of air handled by the engine, the more it is speeded up by the engine, the greater the force built up to thrust the plane forward.

Thus we can see that it's the reaction to the force built up by the engine within the plane that moves the plane forward. That is why we call jet engines **reaction-type engines**.

Now that we have touched on the broad fundamentals of jet engines, let's see how one works.

Air comes in through the intake at the front and goes to a **compressor**. There it is squeezed together and forced into the **combustion chambers**, which are tubes arranged in a circle around the engine. There are nozzles in the front end of the combustion chambers to which fuel is pumped and injected as a spray into the air. The fuel is ignited, and once started it burns continuously, just like a blow torch.

The combustion causes the air and burned gases to expand tremendously, just as it does in the cylinders of the engines we have been talking about previously. They push out toward the exit in the rear. But before they can get out they have to pass through the **turbine**. They hit the turbine wheel blades, which makes the wheel rotate at high speed. This makes the compressor rotate at the same speed, as the two are fastened solidly to one shaft. That

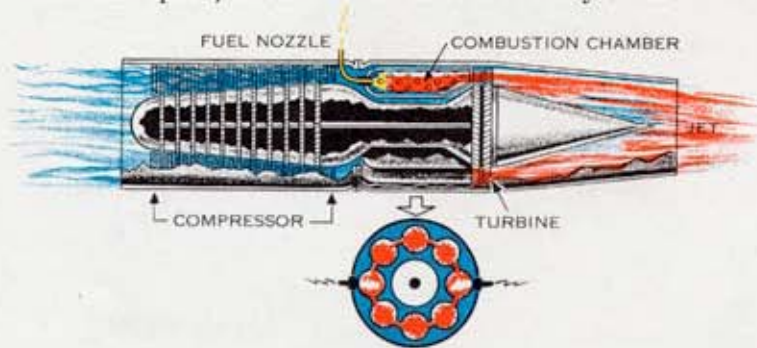

is the only reason for the turbine—to drive the compressor and some accessories.

The gases keep on moving—out the tailpipe. At the exit end the tailpipe becomes smaller, so the gases go still faster as they shoot out into the atmosphere. This is the jet which drives the plane—or more accurately, it is the reaction to the force of this backward jet which moves the plane forward.

Before we get into the details of this engine, we might mention two things that perhaps have already been noticed. One is that a jet engine operates with a continuous flow of power. There is no cycle as in an automobile engine. The same events take place—intake, compression, combustion, exhaust—but they all go on continuously. The second—which is tied in with the first—is that all the principal parts rotate. They do not go up and down like the pistons of the other type engines. That is why we often distinguish between the two types by speaking of **jet engines** and **reciprocating engines**.



Continuous flow

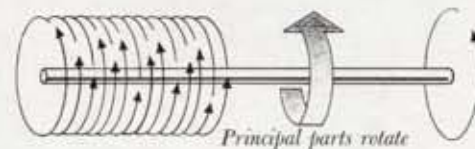

Principal parts rotate



We have mentioned before the importance of air to an internal combustion engine—that it is really an air engine. This is even more true when it comes to a jet engine, because it uses air in tremendous quantities and it uses it for more than one purpose.

For example, in one typical jet engine about 1,000,000 cubic feet of air are forced through it every ten minutes. In ten seconds it would use all the air in an average house. Only about one-quarter of this air is burned with the fuel in the combustion chamber—the other three-quarters has other uses.

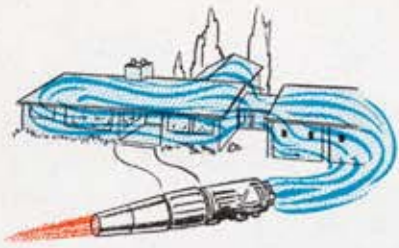

Actually the compressor, which pulls in the air and forces it through the engine, has three jobs to perform. It must:

1. Supply air for combustion. This is necessary just as in any other engine.
2. Supply enough air for the

internal cooling of the engine. We would like to run jet engines even hotter than we do, because we would get more power from them. But the materials will not stand it, so we cool the hot gases with excess air.

3. Furnish the greatest possible weight of air flow for the engine. The thrust of the engine varies directly with the weight of the air forced through it ( $F = MA$ ). Thus, with certain qualifications, the more air, the more power.

There are two kinds of compressors commonly used in jet engines—the **centrifugal** type and the **axial flow** type.

In the axial flow compressor there are alternate rows of rotating and stationary blades. The former, called **rotors**, are attached to the main shaft. They accelerate the air as it comes in. The latter, called **stators**, are attached to the compressor casing. They slow the air up and re-direct it, thus compressing it as it travels through the narrowing path to the combustion chambers.

The centrifugal type is essentially the same as the supercharger we described in connection with reciprocating aircraft engines. There are two principal parts to it, the **impeller** and the

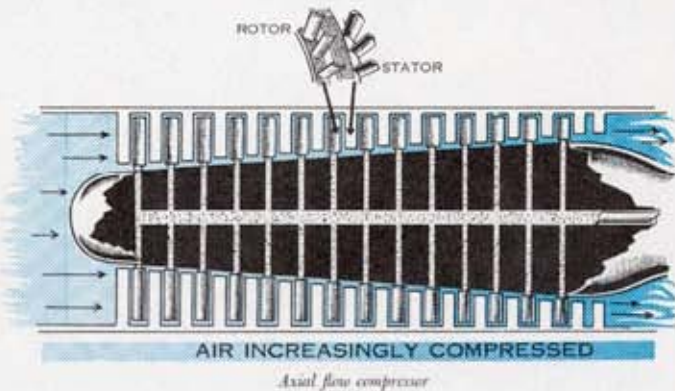

*Axial flow compressor*

**diffuser.** The air comes in near the center and the impeller throws it outward, giving it high velocity. The diffuser changes that velocity into pressure. Thus with either type, the result is that a large amount of air is forced into the combustion chambers under pressure.

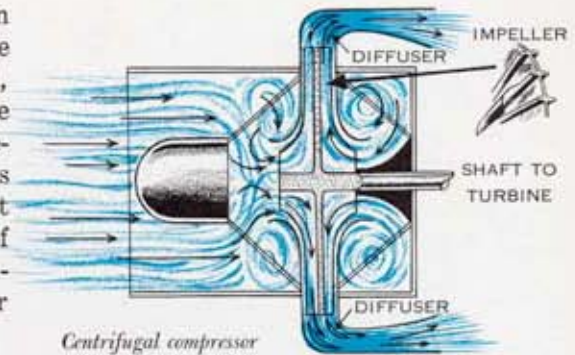

*Centrifugal compressor*

As we mentioned before, the compressor—either type—is driven by a turbine located behind the combustion chambers. The rotating part of the compressor is fastened to one end of a shaft. The turbine wheel is fastened to the other end of the same shaft. So the two rotate together, at the same speed, at all times. Power from the turbine is also used to drive the fuel pump, generator and other accessories.

The turbine wheel is driven by the hot gases from the combustion chambers. These gases, expanding from combustion, are under high pressure and fighting to get out. They first pass through a nozzle, which greatly increases their speed and provides proper direction and distribution. This increases the impact force as they strike the blades of the turbine wheel and spin it at a high speed.

It takes a great deal of power to drive the compressor. Approximately two-thirds of the energy in the gases goes to drive the turbine wheel, which of course reduces by that amount the energy left in the jet for propelling the plane. Nevertheless, this is the simplest and

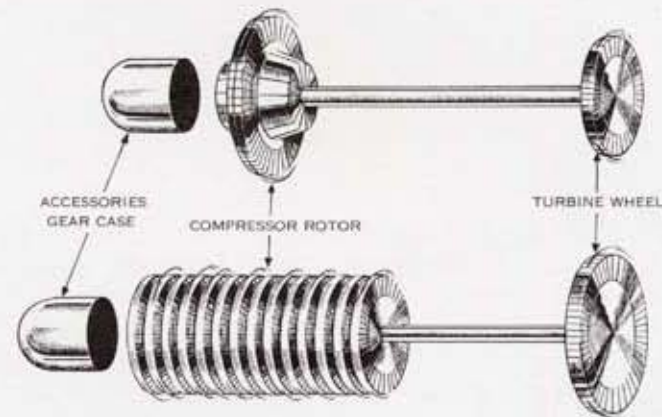

## A POWER PRIMER

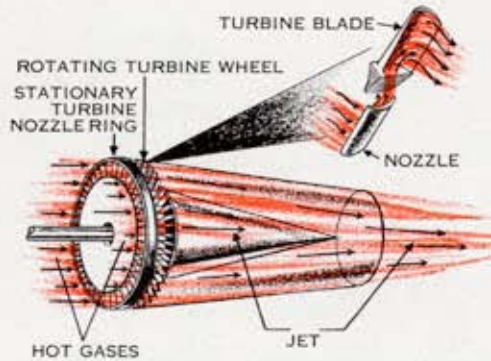

most efficient way of getting the power required to drive the compressor.

The turbine wheel has a tough job to take care of. Each small blade harnesses more horsepower than a modern automobile engine. Some wheels rotate at more than 11,000 revolutions per minute, with the tip of each

blade traveling at a speed of almost 900 miles per hour. But the worst part of it is that the blades must operate continuously at a temperature of well over 1500° Fahrenheit. Metals ordinarily become weaker at high temperatures, and this combination of extreme stresses and high temperatures of the turbine blades has been one of the greatest problems in producing jet engines.

The science of metallurgy has played a large part in the development of these engines, not only in connection with the turbine blades but many other parts as well. And this important role will continue as new materials are developed which can withstand even higher temperatures, and thus make possible more power and greater efficiency from these engines.

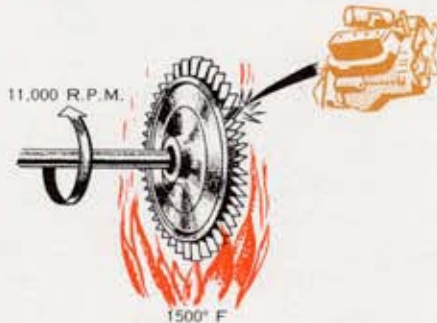

The fuel system of a jet engine is one of its most complex and sensitive parts. At first thought it would seem to be simple—all we have to do is spray fuel continuously into each combustion chamber and let it burn. But there are a lot of things that must be taken into account in determining the quantity of the fuel, the form in which it is sprayed into the chambers, and so forth.

## AIRCRAFT ENGINE

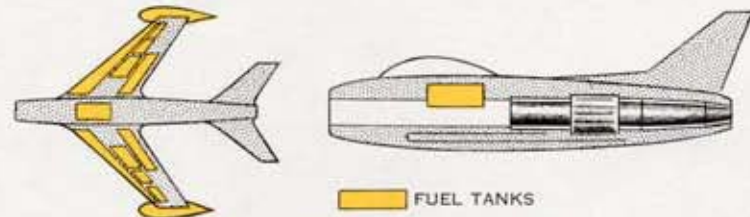

There are many small parts to the fuel system with which we will not concern ourselves—filters, auxiliary pumps, check valves, drain valves, etc. Considering only the major items, we start with the fuel pump. This brings fuel from the tank and forces it to the fuel control.

The fuel control is the “carburetor” of a jet engine. It meters the fuel, making sure that the engine gets the correct quantity at all times. And that is a real job, considering all the variations in speed, altitude, temperature and so forth which can affect it. Without going into details of how it does these things, we will simply say that it consists of a series of valves and regulators which control the fuel in accordance with the density of the air, engine speed in revolutions per minute, and the throttle opening as set by the pilot.

From the fuel control the fuel passes through the manifold tubing which encircles the engine. From this, flexible tubing leads to the nozzles. There is a nozzle in each combustion chamber from which the fuel is sprayed into the hot air where it immediately starts burning.

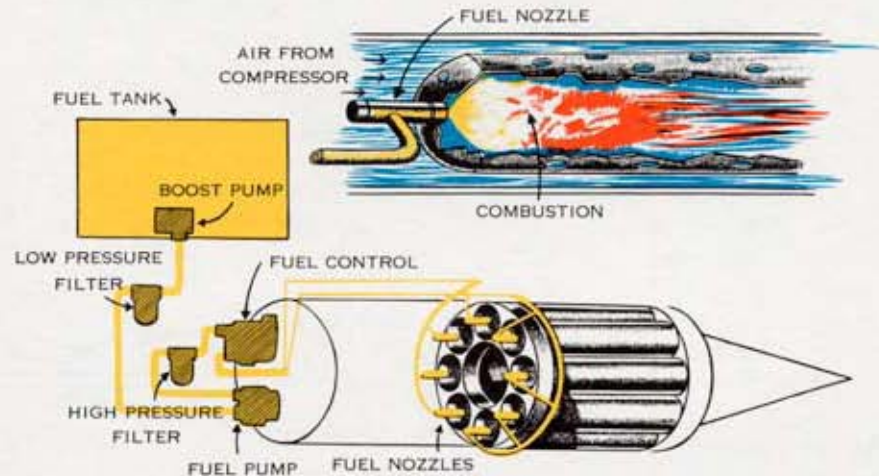

## A POWER PRIMER

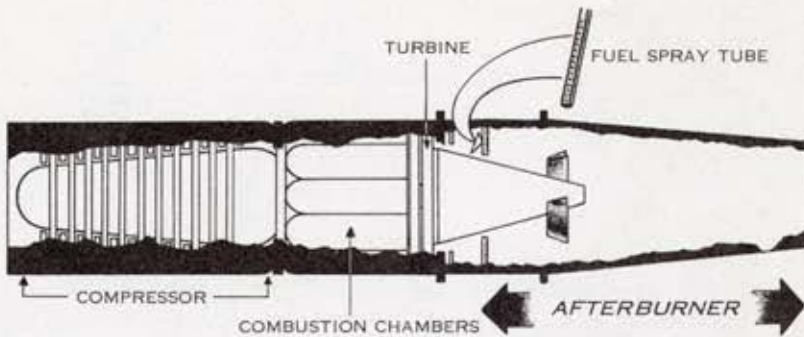

Most jet engines now are equipped with **afterburners**. This is an arrangement for getting more power out of an engine when maximum speed or performance is required for some particular purpose, and is often used for only short periods of time. One thing which limits the power of an engine is the temperature of the turbine blades—we cannot let them get too hot. Otherwise we could keep pumping in more fuel and get more power, inasmuch as we always have more than enough air to burn with it. So we get around this difficulty by starting a new fire behind the turbine. That is where it gets its name, afterburner.

The mechanism for doing this is mainly an auxiliary fuel system. A pump forces fuel to the fuel regulator, which meters the correct amount according to the quantity of air passing through the engine. This goes to the afterburner fuel manifold, which is located a short distance behind the turbine. It consists of a series of spray tubes, each with a number of small holes drilled in it. These holes inject fuel into the stream of hot gases, which still contain a great deal of unburned air. The burning of this fuel expands the gases and speeds them up, and being behind the turbine, the higher temperature offers little difficulty. The afterburner may increase the thrust of the engine almost one-third, but it burns a lot of fuel in so doing and therefore is used only when necessary.

Just one word about the fuel itself. When jet engines were first introduced most of them used kerosene. At times they have used high-octane aviation gasoline, mostly because it was available and necessary for reciprocating aircraft

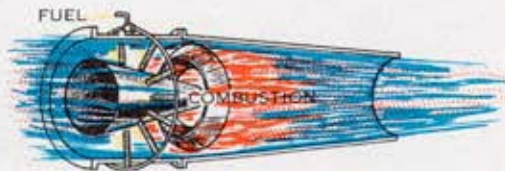

## AIRCRAFT ENGINE

engines. Experimental engines have been run on oil so thick that it would hardly seem possible to inject it into the combustion chambers. Thus we can see that jet engines can be operated on a very wide range of fuels. But the military specifications are very strict in regard to qualities of the fuel affecting its safe handling, the effect of high and low temperatures, altitude changes, and such things. And perhaps most important, the fuel must have a high BTU content. For after all it is simply the heat we get out of the fuel which furnishes the energy to drive the plane.



Sometimes the ignition of jet engines is practically forgotten, probably because the electrical ignition system is used for such a short time. All we have to do is get the mixture burning in the combustion chamber, and after that the fuel starts to burn almost as soon as it leaves the injection nozzle. Except for starting, jet engine ignition is simply the heat from the combustion which is already taking place in the combustion chamber.

But we do have to get it started in the first place, and there are several types of electrical ignition systems which can be used for this purpose. Some are quite similar to those we have already seen. They use a coil or transformer to get the high voltage needed, and some may have a vibrator or breaker just as with a reciprocating engine. The **igniter plugs**—in jet engines we usually call them igniter plugs instead of spark plugs—also operate in the same familiar fashion. Our source of current is the regular aircraft electrical system of 24 volts.

One new thing is that we have only two igniter plugs for the

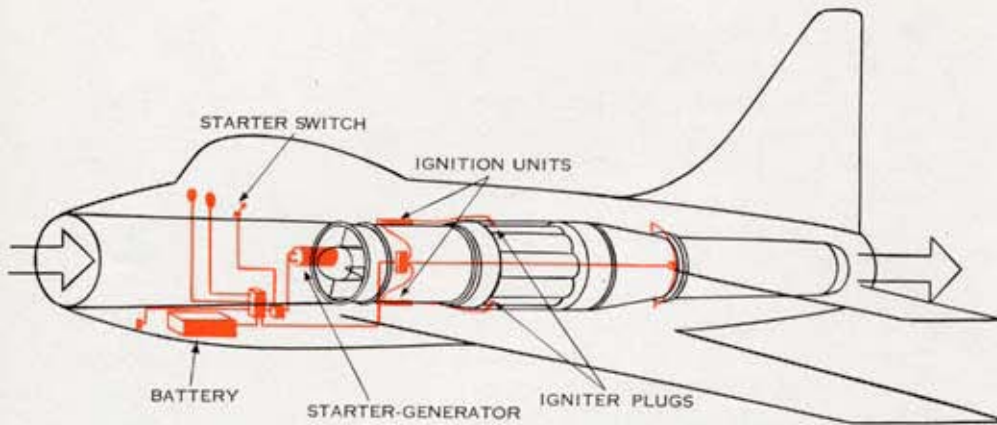

entire engine. One is in a combustion chamber on one side of the engine, and the other in a combustion chamber on the other side. All the chambers are connected by open tubes for ignition and for equalizing pressures, so as soon as combustion is started in one place it almost immediately jumps to all the other chambers.

Another type of ignition system coming into more general use is the **capacitor discharge** type. This incorporates a capacitor in the system, which has the characteristic of being able to store up energy and then suddenly release it at the proper time. There are several variations of this. It can be designed to operate from different sources of electricity, and some times it is a self-contained unit furnishing its own stepped-up electrical energy. In some cases a high voltage is used as in the more conventional systems, but usually it works with only low voltage throughout the circuit. In the latter case a different type of igniter plug is necessary.

The main advantage of the capacitor type is that it gives a hotter spark, which is particularly helpful at high altitudes or cold ground temperatures. Ignition is more difficult when the plane is way up from the ground. There are several reasons for this, mostly the lower density of the air and the very low temperature. Formerly this did not make so much difference, but with multi-

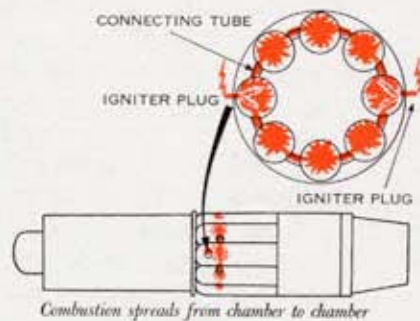

engine planes it is often desirable to cut out some engines when cruising and then start them again when necessary, so we want to be sure that the mixture will ignite under any circumstances.

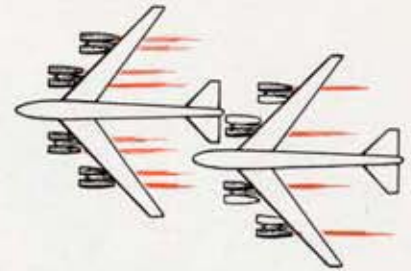

We have still another thing on jet engines which should be considered an ignition system. This is for the afterburner, and while it is actually part of the fuel system, it acts as an ignition system. Immediately in back of the turbine there are two fuel nozzles.

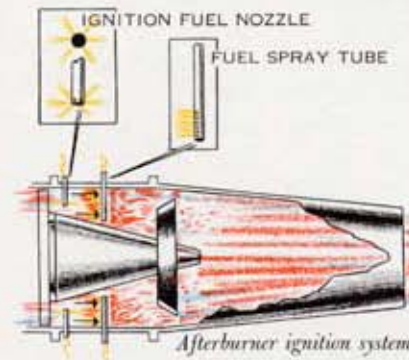

When the afterburner is turned on, fuel is injected from these nozzles and instantly ignites from the temperature of the hot gases passing through the turbine. This hot streak of flame is carried back to the afterburner where it in turn ignites the fuel being squirted out of the holes in the fuel

manifold. As soon as this main supply of fuel is burning, the ignition fuel nozzles are automatically shut off.

### WHY Jet Engines?

What has made jet engines progress so far in such a short time? What do they have that is so important?

The answer is very largely in two words—*speed* and *altitude*. They pack immense power in a small space with comparatively little weight, and they can make an airplane go faster than it ever went before. They can reach higher altitudes as they are not limited by the inefficiency of propellers at these altitudes.

There are other advantages—no warm-up before take-off, good performance at high altitudes, ability to burn low-cost fuels, greater pilot comfort. These all help, but what actually started all the excitement about jet engines was the expectation of higher plane speeds. With no propeller limitations on speed and with the increased power available, the jet engine has delivered as expected.



We now have planes which can exceed the speed of sound and which can take off and climb to a height of eight miles while an automobile is being driven around the block.

The jet engine was originally thought of only for small fighter planes, but it is now being used in bombers of various

types, cargo carriers and commercial transports. And the basic principles are being used with different mechanical arrangements in even wider fields.

One of these is the **turbo-prop**. As the name indicates, this plane has propellers and looks like a conventional plane. But it has jet engines. Perhaps we should call them gas turbine engines, but they are very similar in principle to the jet engines we have been describing. The main difference is that more of the energy of the gases is harnessed by the turbine to drive not only the compressor but a propeller as well. This leaves very little energy in the gases to produce jet thrust.

The mechanism for this is comparatively simple. We extend the shaft of the turbine and compressor and fasten a propeller on the front end. We put a reduction gear in between to keep the propeller speed within practical limits. Then we add more stages to the turbine—that is, more turbine wheels—so that more power goes to the shaft and less out the jet.

For certain types of operation the turbo-prop offers several advantages—economy of operation, little noise and vibration, the advantage of the propeller for take-offs and landings on moderate-sized air strips—and again, high power with low weight. Even with the weight of the shaft and reduction gear, this unit pro-

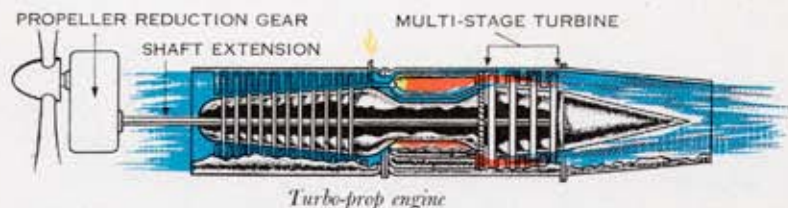

*Turbo-prop engine*

duces more than two horsepower per pound of weight, twice as much as the most powerful piston type engines.

The turbo-prop illustrates how we can use jet engine principles to make a shaft turn just as we do with other types of engines. This means that gas turbine power can be used in many fields other than aircraft, and it has been tried out in ships, locomotives, stationary power plants, and motor vehicles. The illustration shows one type of gas turbine as installed experimentally in a motor vehicle.

In such installations the power turbine usually is not connected directly to the compressor-turbine unit. It is on a separate shaft, but is located right behind the first turbine and driven by the expanding gases just as if it was another stage of the same turbine.

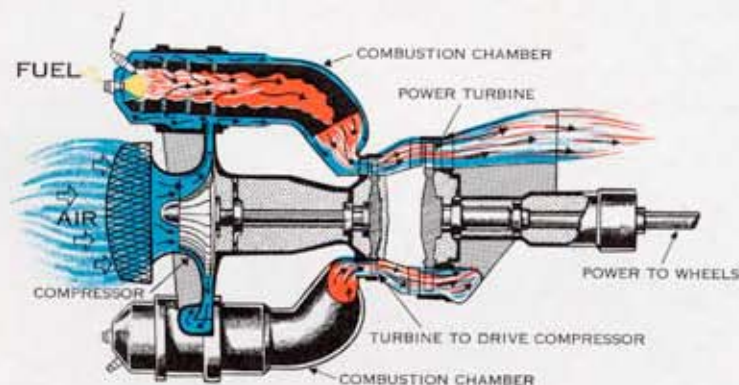

*Automotive gas turbine*

Thus we have two sections. The first is the **gasifier** section, consisting of the compressor, combustion chambers and turbine. Behind this is the **power** section, which is made up of the power turbine and whatever transmission and final drive gears are required. The first section simply provides a supply of hot, compressed gas, and the second section extracts energy from this gas and delivers power to the rear wheels. The two sections are entirely separate mechanically.

The gas turbine has advantages and disadvantages. We can produce a great deal of power from a small, light unit, but there are problems with high fuel consumption and with materials to withstand the temperatures and stresses encountered. Many engineers, however, believe that these problems will be overcome



and that the gas turbine will be the power plant of the future, opening even more fields to the internal combustion engine.



We have seen that there are many differences between aircraft engines and automobile engines. The radial reciprocating engines have cylinders and pistons very similar to those in automobiles but they are put together in a new way which makes them look quite different. Jet engines not only look different but practically all of their parts and pieces are new to an automobile man.

But when we get down to fundamentals and to our three basic elements, the story is not the same. Appearances are deceiving, as is so often the case. These engines all depend on getting air and fuel into the right place and igniting them at the right time. They all depend on the expansion of the burning gases to furnish their power. If we can keep the AIR, FUEL, and IGNITION systems functioning properly, we don't have to worry very much about other differences in the various types of engines.

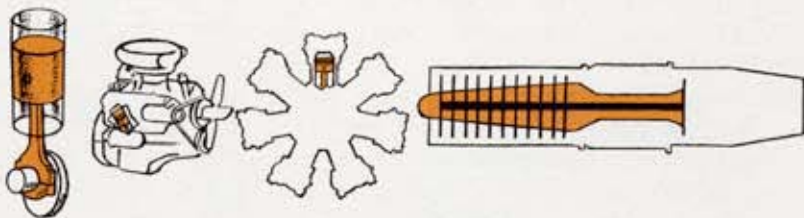

## Diesel Engine

THE Diesel engine has had considerable publicity in recent years. It has made headlines in various fields, and almost everyone has heard of it. But little has been said about what a Diesel engine actually is. The impression has been given that this is an entirely new kind of engine. Many men who would not hesitate to tackle a repair job on an automobile engine will not even check the oil on a Diesel. They claim they don't know anything about them.

But there is nothing very different about a Diesel engine. It is just an internal combustion engine like the others we have discussed. It is again just a question of getting air and fuel into a cylinder and igniting them. AIR, FUEL, and IGNITION again.

Some of the early engines might well have frightened away the amateur mechanic. Two stories high with a platform around the top for the operator, the bore and stroke measured in feet rather than inches, running 150 or 200 revolutions per minute—these certainly did not resemble an automobile engine in any way. And yet even these followed the same principles of operation of the internal combustion engine. Such engines are still being built, but it was the so-called "high speed" Diesel which first attracted much public notice, and that is the kind we are going to discuss here. Much of what is shown will apply to the low speed engines as well, but we will concentrate on the lighter, high speed engines commonly used in moving vehicles. "High speed" does not mean what it does in a gasoline engine. It means about 1500 to 3000 revolutions per minute, against perhaps 4000 or 5000 in the gasoline engine.

We will go back to our basic cylinder unit again and see what we must add to make a Diesel engine out of it. First, we need some valves—intake and exhaust. Instead of a carburetor we have an **injector**. We do not need a spark plug, so we will put

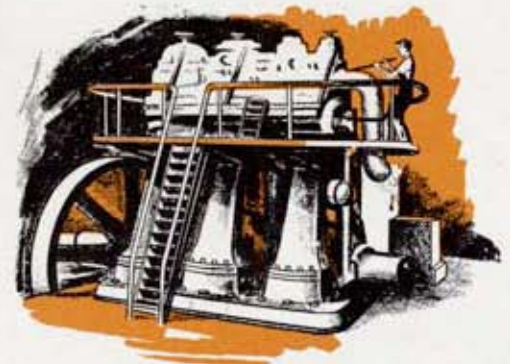

### A POWER PRIMER

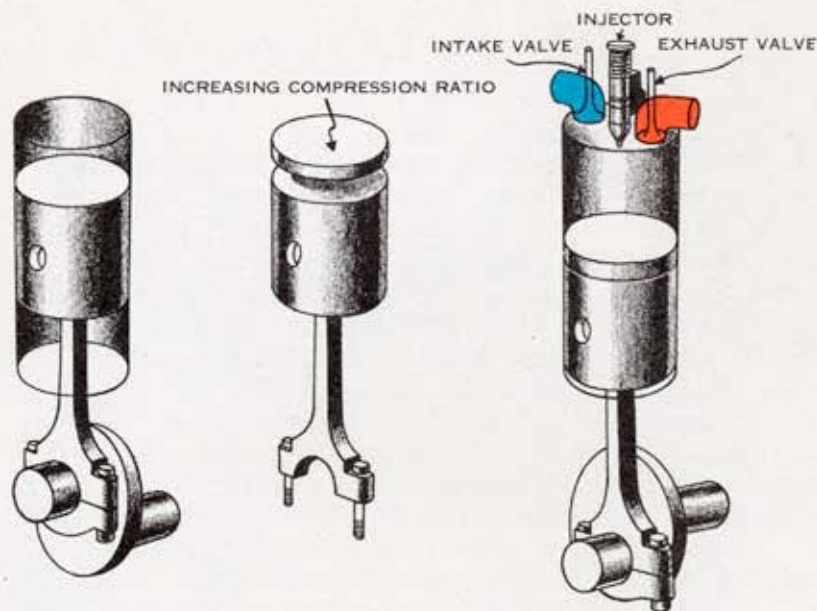

the injector in its place. And there already we have all the parts necessary for a Diesel engine.

We do have to make one other change however. We must increase the compression ratio. We mentioned in the early part of this book that the higher the compression ratio of an engine, the higher its efficiency. That is, we can get more power from the same amount of fuel, or the same power from less fuel. One of the principal advantages of the Diesel engine is its ability to use a high compression ratio. These engines have a compression ratio of about 16 to 1, some lower, some higher. That means that the piston at the top of its stroke has squeezed the contents of the cylinder up into a small space only  $\frac{1}{16}$  the size of the cylinder when the piston was at bottom dead center. The automobile engine has a compression ratio of 8 or  $8\frac{1}{2}$  to 1. The easiest way to make the change for our purposes here is to simply add some material to the top of the piston so it will come closer to the cylinder head. In actual practice of course all the parts of the engine would be designed to give the proper compression ratio.

Let us run this engine through one cycle. On the intake stroke, one valve is open and as the piston goes down it draws in a cylinder-full of air. *Air, not air-fuel mixture.* The valve closes and the piston rises, squeezing that air up into a small space at

### DIESEL ENGINE

the top of the cylinder. We have mentioned before that air—or any other substance—gets hot when it is compressed. This is the basis of the Diesel engine, however, so it is worth repeating here. The piston squeezes that air into such a small space, pushes on it so hard, that it gets very hot. Its temperature rises to 1000 degrees or more. Just at this time the injector squirts a stream of oil into the cylinder. The oil mixes with the hot air and starts burning, as that 1000 degrees is more than hot enough to ignite it. The burning mixture expands just as in the carburetor engines we have talked about. But it expands more because of the higher compression pressure before ignition. The piston is pushed down and turns the crankshaft. This of course is the power stroke. Then the exhaust valve opens and the piston rises and pushes the burned gases out. This completes the cycle and we are ready for the intake stroke again.

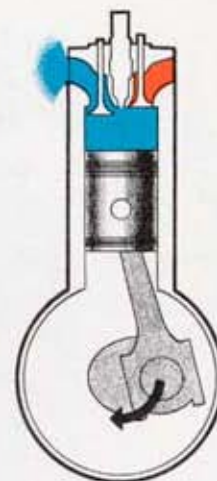

It is easy to see the main differences between the Diesel cycle and the Otto cycle. In the Diesel cycle we mix the air and fuel after compression; in the other we mix them before compression. The compression pressure is much higher in a Diesel engine. And there is no electric ignition—we have **compression ignition** in a Diesel. Other minor and more technical differences will come out as we go along.

### TWO-CYCLE Diesel

We have just described the principles of a four-cycle Diesel engine. But there is another important type—the **two-cycle** Diesel.

The full name—two-stroke cycle—gives us an idea of what it is. Instead of going through four strokes of the piston, two up and two down, and then repeating, we have only two strokes for the complete cycle, up and down. The cylinder fires once for each revolution of the crankshaft. We have only a compression stroke and a power stroke; in between or during these we must take care of the intake and exhaust.

This is not a new idea, and it is not limited to Diesels. We have always wished we could get rid of those two intake and exhaust strokes—wasted as far as power is concerned. Twice as many power strokes means twice the power. There have been

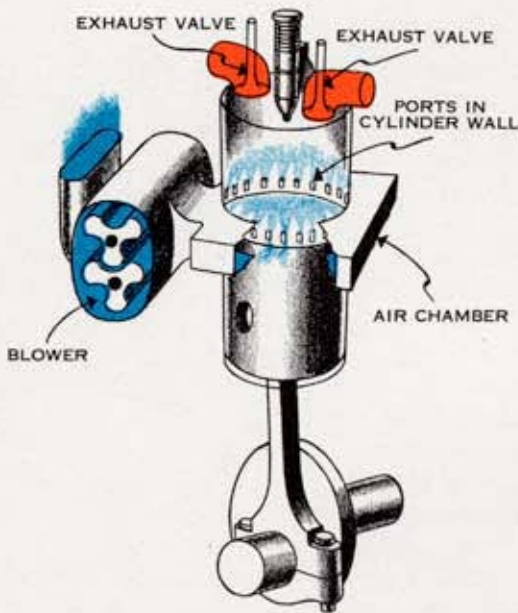

many two-cycle gasoline engines built, but their commercial use in this country has been limited in general to small sizes and special purposes. There is still considerable experimental activity on two-cycle gasoline engines, and we may see a much larger field of use for them in the future. But the two-cycle Diesel has already made its mark, so in this book we will limit our discussion of two-cycle engines to the Diesel type.

Suppose we take the four-cycle engine we have just been discussing, and convert that to one of the two-cycle variety. We leave the valves there, but they are now *both exhaust* valves. We do not have to change the injector. But we have to get the air in some way. So we cut a row of holes, or ports, in the cylinder wall. These are covered and closed off by the piston most of the time, but are uncovered as the piston nears the bottom of its stroke. The air comes in here.

A four-cycle engine on the intake and exhaust strokes is really acting as an air pump. Since we have eliminated those strokes in the two-cycle engine, we have to supply another air pump, outside the engine. So we add a blower to blow the air in the ports.

We now have a complete two-cycle Diesel engine. Assuming the piston at the the bottom of its stroke, just starting up, the intake ports will be open and the exhaust valves will be open. Air is being blown in the ports and is pushing the exhaust gases left from the previous cycle out

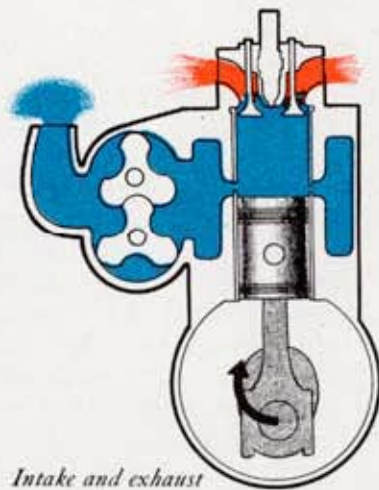

Intake and exhaust

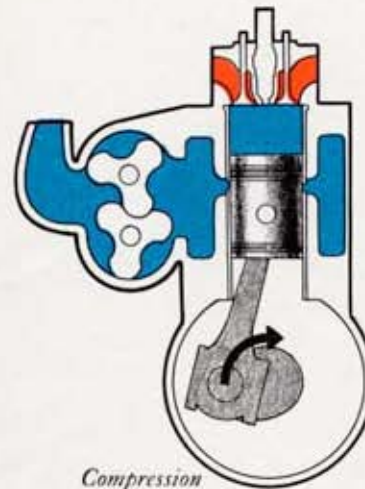

Compression

through the valves. When the piston is about a quarter of the way up, the valves will close and the ports will be covered. The exhaust gases have all been blown out and the cylinder is full of fresh air. The rest of the stroke is an ordinary compression stroke squeezing that air into a small space at the top.

Just before top dead center the injector shoots a spray of fuel into the chamber full of hot air. Ignition and expansion take place just as in the four-cycle engine, and the piston starts down on the power stroke. A little more than halfway down, the exhaust valves open and the burned gases start to escape. As the piston goes farther, it uncovers the ports and fresh air is again blown into the cylinder. Just as before, this helps to get the exhaust gases out, and also fills the cylinder with air. The piston has reached bottom dead center and the cycle is complete, all in one turn of the crankshaft.

We can see that the compression and power strokes are not much different than we have been used to in four-cycle engines. But the exhaust and intake take place more or less together and in a much shorter length of time. (See page 85.) We cannot use the piston to push the exhaust gases out, so we have to blow them out with air under pressure. We cannot draw the air in by the movement of the piston, so we have to force it in. The blower takes care of both of these requirements.

The two-cycle engine, by having a power stroke every revolution, can produce about twice the power of a four-cycle engine of the same size and almost the same weight. The blower of course uses up some power. The heaviness of Diesel engines has always been one of their greatest disadvan-

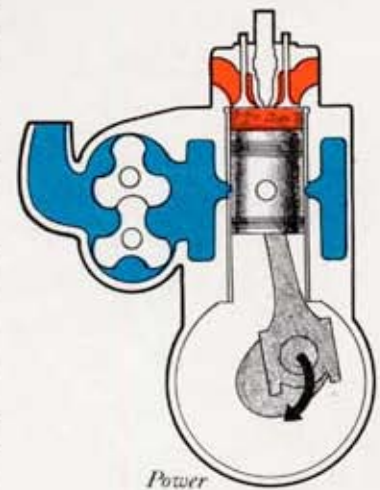

Power

tages, particularly for use in vehicles of any sort. So the smaller, high-speed, two-cycle Diesel has been very successful in opening up new fields for this type of engine—fields in which the Diesel was formerly believed to be impractical.

### Mechanical Features

Diesel engines are composed of single cylinders put together in various arrangements, just as we have seen the automobile and aircraft engines formed. We can fasten the cylinders together any way we please, depending on what we are going to

use the engine for. The most common is the in-line type, with anything from 2 to 8 cylinders. But there are also opposed piston engines, and air-cooled radial engines looking very much like gasoline aircraft engines. Most of the Diesel-powered trains have V-type engines.

One rather different design is known as the "pancake" engine. It is really a four-bank radial. It is built up of four radial engines, each having four cylinders. In operation it is mounted vertically, its crankshaft on end, so that the four radials give the appearance of a stack of wheat cakes on a plate.

With so many different sizes and types of Diesel engines, their construction naturally varies widely. The smaller, high

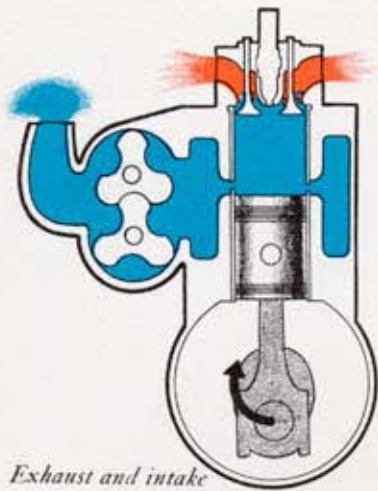

Exhaust and intake

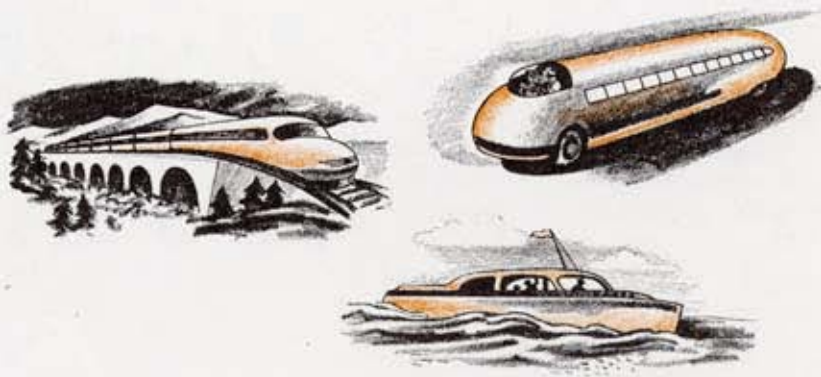

### DIESEL ENGINE

#### FOUR EVENTS OF 4 CYCLE

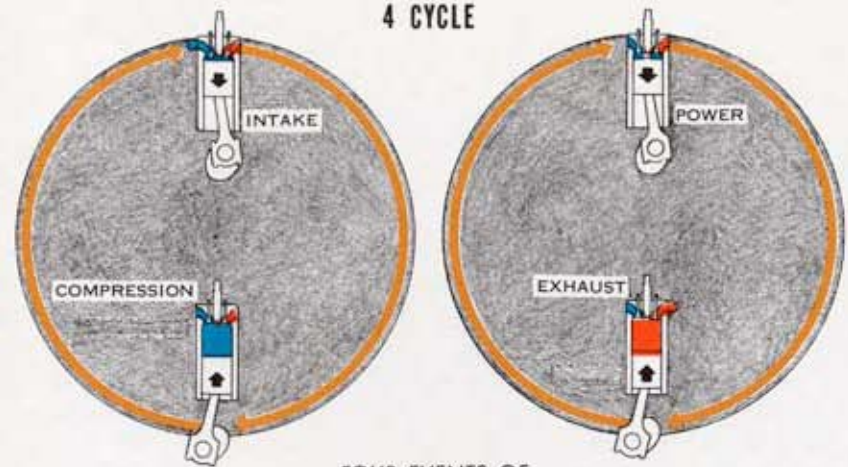

#### FOUR EVENTS OF 2 CYCLE

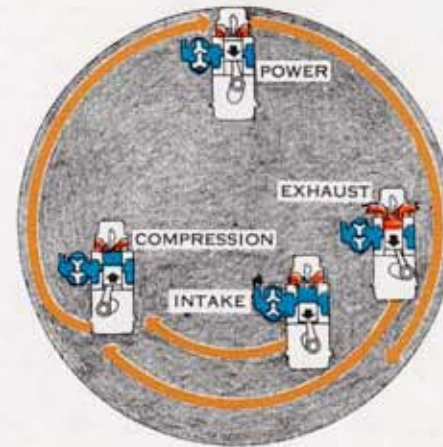

Each circle represents one revolution of the crankshaft. It goes around in a clockwise direction.

With the four-cycle engine, two circles are needed for the complete cycle. The first circle represents the intake and compression strokes, the second the power and exhaust strokes.

The two-cycle engine completes its cycle in **one revolution**. Exhaust and intake take place at the same time at the bottom of the circle. Then compression occurs as in the first circle above, and then the power stroke as in the second circle above.

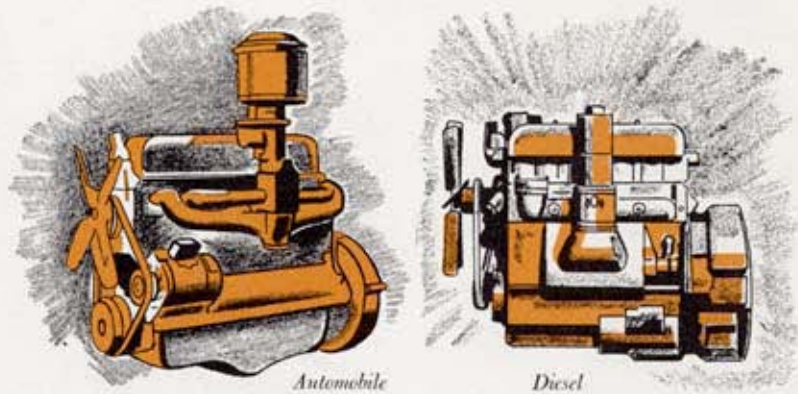

speed engines, however, follow the general practices of the automobile engine, and in many cases the casual observer would have difficulty in telling one from the other.

The crankcase and cylinder block are cast in one piece, but a separate **liner** is inserted in each cylinder. This is like a length of tubing which fits in the hole in the block, and provides a replaceable cylinder wall against which the piston rubs. The connecting rods and pistons are similar to the automobile type, though the top surface of the piston will probably have a depression or some other irregular shape instead of being flat. This depends on the type and shape of combustion chamber, more of which will be explained later.

An overhead valve mechanism is used, with the usual push rods and rocker arms. Sometimes the camshaft is located near the top of the engine, and the push rods are very short. In considering the two-cycle engine, we should always bear in mind that the camshaft runs at the same speed as the crankshaft. In the four-cycle engine the valves are opened only every two revolutions, so the camshaft runs half as fast as the crankshaft. In the two-cycle, the valves must open every revolution, so the camshaft runs at crank-

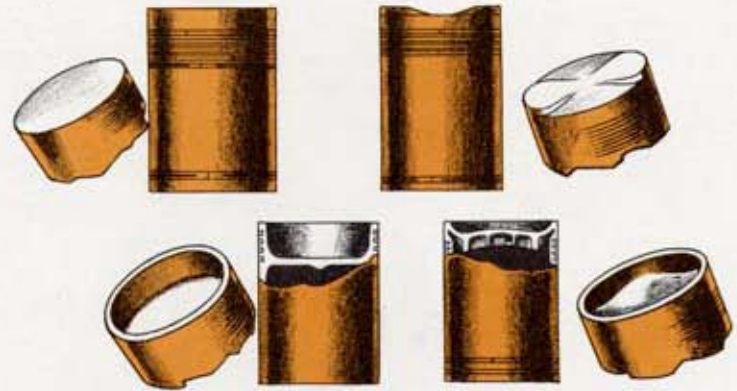
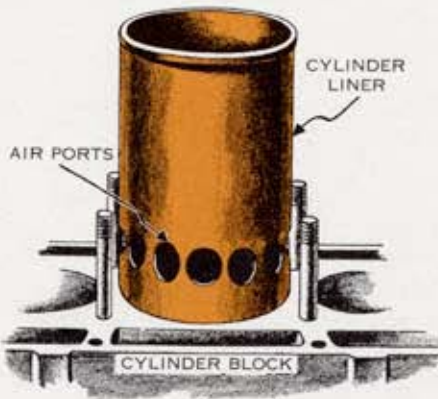

shaft speed. It is just a question of the size of the gears driving the camshaft from the crankshaft.

Diesel engines must of course be lubricated and cooled. The systems generally used are just about the same as for the automobile engine, so we will not go into those again.

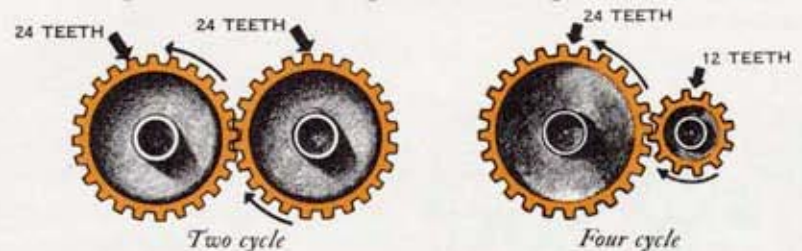

One thing about the construction of a Diesel engine which should be mentioned is that most of its parts are heavier than those of a similar gasoline engine. This is natural, in view of the higher pressures inside the cylinder which these parts must withstand. The situation is quite different than it used to be however. Some of the early Diesels weighed as much as 250 pounds per horsepower. Today one standard engine produced in



large quantities weighs less than 10 pounds for each horsepower, and some special engines are below 5 pounds per horsepower. Changes in design and improvement in materials are both responsible for this great decrease in weight.



Getting the air into an ordinary four-cycle Diesel engine is just the same as getting the fuel-air mixture into an automobile engine. The overhead valve opens, the piston goes down, decreasing the pressure in the cylinder, and the outside atmospheric pressure forces air in. The only thing we have to remember is that it is air only, and there is no fuel mixed with it when it enters the cylinder.

But in the two-cycle engine we have a different set of conditions. We must get the air into the cylinder in a short space of time and without the help of the pumping action of the piston. As we have said, we use a blower for this. Some engines use a centrifugal blower, the same thing we have already seen as an aircraft engine supercharger. This must turn at very high speed to be effective, and most of the Diesels use a different type.

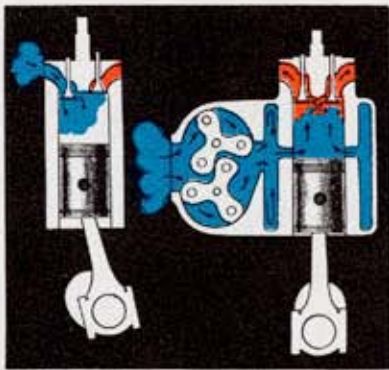

But let us look at the air system of one type of two-cycle Diesel and see how it works.

The blower is what is commonly called a **Roots blower**. This is a casing in which there are two rotating parts, or rotors. Each has three lobes which fit together like gear teeth as the two rotors are driven around. They are driven from the engine crankshaft. Air is drawn in through an air cleaner and carried around the outer side of the rotors to the outlet. The lobes on the rotors

Diezel and see how it works.

The blower is what is commonly called a **Roots blower**. This is a casing in which there are two rotating parts, or rotors. Each has three lobes which fit together like gear teeth as the two rotors are driven around. They are driven from the engine crankshaft. Air is drawn in through an air cleaner and carried around the outer side of the rotors to the outlet. The lobes on the rotors

DIESEL ENGINE

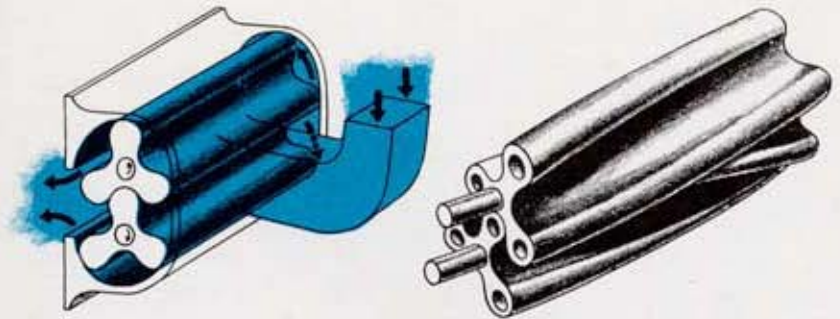

may be straight or may be twisted into a spiral form to give a constant, uniform flow of air.

The air is forced by the blower into the air chamber, which entirely surrounds the lower part of the cylinders. Thus we have a whole compartment full of air under pressure. When the piston uncovers the ports in the cylinder wall, this air rushes into the cylinder. The exhaust valves are open and the burned gases are already going out, but this blast of fresh air comes in behind them and blows them out quickly.

This arrangement of ports and valves is sometimes called a **uniflow engine**, because the air comes in at one end of the cylinder and air and exhaust go out at the other end. The flow is always in one direction.

There is a different form of high-speed, two-cycle Diesel engine which employs what is known as **loop scavenging** instead of uniflow scavenging. This simply means that the air from the blower is brought in through ports on one side of the cylinder, while the exhaust is carried out through ports on the other side. The incoming air sweeps through the cylinder in a swirling loop, from which we get the name loop scavenging.

The swirling or looping action of the air in the cylinder is aided by the slope of the top of the piston and the directional flow given the air by the shape and slant of the intake ports. The air rushing in from the blower is carried through passages around the cylinder walls, through the air intake ports, and

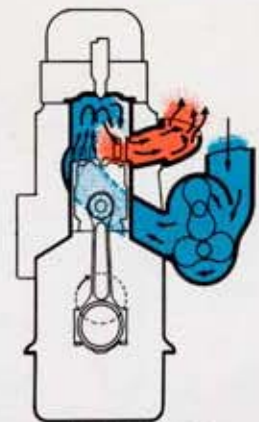

Loop scavenged engine

forces the exhaust gases out of other ports in the cylinder liner into the exhaust manifold. It is just like airing out a smoke-filled room by opening windows on opposite sides and letting the wind blow through. As the piston rises, it closes off the ports and air is trapped in the upper cylinder and compressed. Then the fuel is injected in the usual manner.

With this design it is not necessary to have the exhaust valves, or any valves at all, so we call it a **valveless engine**. This does away with the push rods and other parts of the valve operating mechanism, which makes it simpler and reduces the number of working parts subject to wear. The camshaft is needed now only to operate the injectors.

Whether we have uniflow or loop scavenging, we ordinarily blow more air into the cylinder than we theoretically need. We put in enough to fill the cylinder and then some more which goes out the valves or exhaust ports with the exhaust gases. It would be difficult to blow out every bit of the exhaust without some of the fresh air mixing with it and going out too. This is one thing which makes it easier to design a two-cycle Diesel than a two-cycle carburetor engine. In a Diesel we do not have to worry about that unburned air escaping. It has advantages, for it cools the valves besides making sure that all the exhaust is cleared out of the cylinder. But if it were a fuel-air mixture being blown in, we would have to be very careful not to let any of it get out the

valves, as otherwise we would simply be wasting that much fuel. In a carburetor engine we would have to do all we could to prevent the unburned charge from mixing with the burned one.

But in the Diesel engine we can just blow a lot of air through and thus be sure that each cylinder will be full of fresh, clean air at the beginning of the compression stroke. And that is the first step in making an engine run satisfactorily.

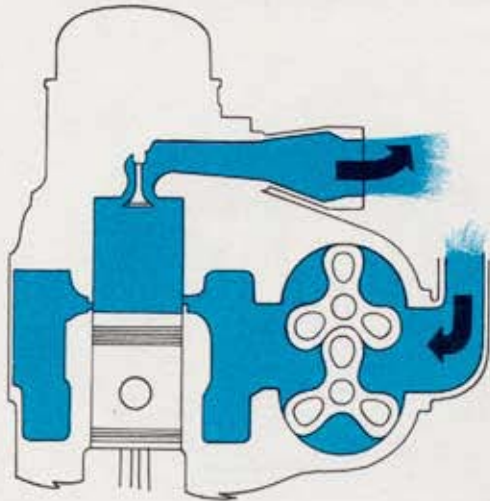

The primary job of the fuel system of a Diesel engine is to see that the proper amount of fuel is squirted into the cylinder at the proper time. The most important part of this fuel system is the injector. It has often been called the heart of the Diesel engine, and improvements in this unit are responsible for much of the success of the small, high speed engines of today. It must measure out the right amount of fuel, inject it into the cylinder under high pressure, and atomize it, or break it up into a fine spray. As we can see, it performs almost the same duties as a carburetor.



The other parts of the system are little different from what we have already seen. There is a tank containing the fuel oil, and a pump, driven by the engine, to get the oil from the tank to the injectors. This pump ordinarily furnishes more fuel than is needed, and there is a return pipe from the injectors to the tank to carry back the extra, unused fuel. There is a filter to clean the oil just before it reaches the

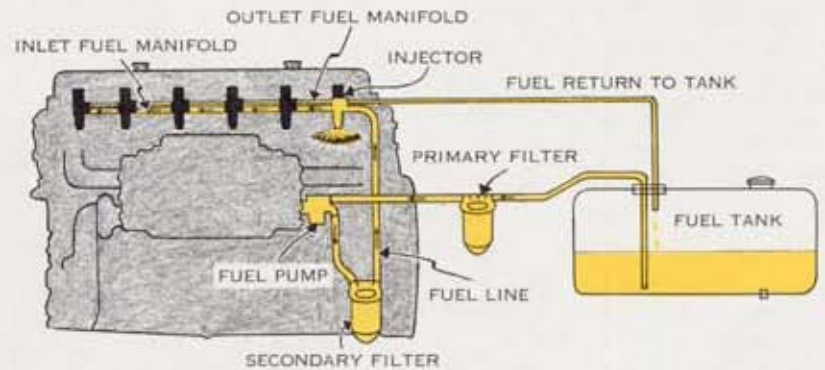

A Diesel fuel system

injectors, and often another filter between the tank and the pump, for dirt is the worst enemy of the injection system.

For many years the fuel was forced into the combustion chamber by highly compressed air. Then air injection gave way to mechanical injection. The "common rail" system was used, in which one pump furnished fuel under high pressure to one pipe or reservoir having branches to all the cylinders. Today the principal types in use provide an individual pump or injector for each cylinder.

An injector is simply a pump. It is a piston-type pump which forces a small amount of liquid under high pressure into the cylinder. It is like a child's water pistol or squirt gun. The simplest form would be a small plunger sliding in a cylinder. Fuel enters through a port in the side wall when the piston, or plunger, is at the top. As the plunger is pushed down it closes the port and begins to squeeze the fuel. As the pressure gets higher the liquid squirts out the hole in the bottom.

But in an actual engine it is not quite so simple. We have to be able to vary the amount of oil pumped, from none at all up to enough to deliver maximum power. And this is difficult because we are dealing in such small quantities. In a Diesel engine of the size for a truck, the greatest amount of fuel injected into a cylinder would be a drop not much bigger than the head of a kitchen match. This means that all parts must be made with great accuracy in order to measure the fuel properly, and all fits must be perfect and with practically no clearance because of the high pressures built up. So an injector is fundamentally an expensive piece of mechanism.

We show one type used on the majority of the two-cycle engines, often called a unit injector. This is because the pump and nozzle are combined in one unit, the whole thing being fitted in the cylinder head. There is one in each cylinder. It is operated by a rocker arm controlled by the same camshaft which operates the valves. Thus there are three cams for each

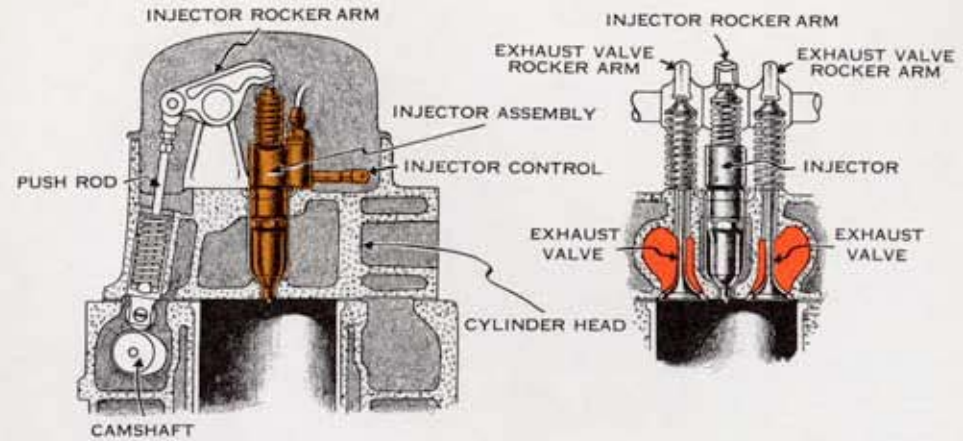

cylinder, two for the dual exhaust valves and one in between them for the injector.

We will not try to explain the details of this injector. It is a pump consisting of a plunger fitting closely in a cylinder, and there are means for varying the amount of fuel it can pump in one stroke. The plunger builds up pressure on the small amount of liquid in the cylinder until this pressure is great enough to open the spring loaded check valve. This may be as high as 20,000 pounds per square inch. When it opens the oil is forced

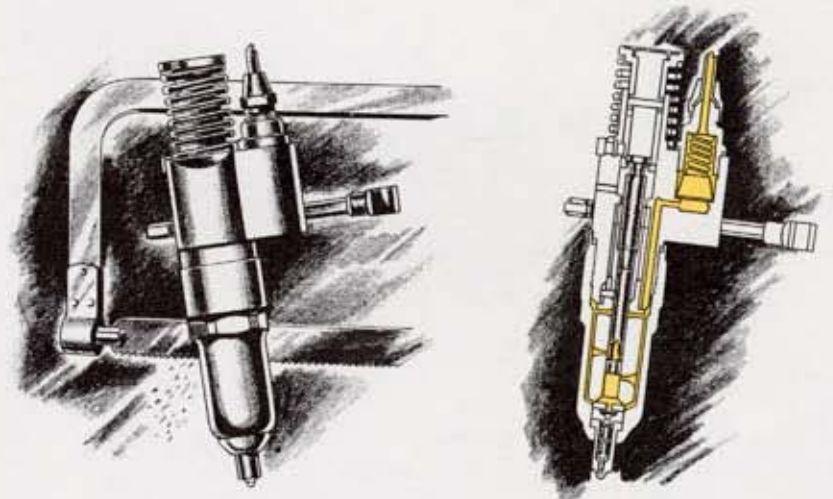



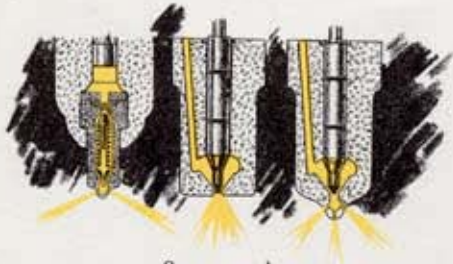

Spray nozzles

into the engine cylinder through a number of very small holes in the nozzle, shooting in all directions in a fine spray. Some nozzles have only one central hole, with a sliding pin in it which gives a cone-shaped spray, like the nozzle of a garden hose when almost closed.

The mechanism for varying the amount of fuel pumped is arranged so that all the injectors on an engine are varied together. They are all adjusted the same amount at the same time, so that all the cylinders will get equal amounts of fuel. Controlling the amount of fuel pumped by the injectors speeds up or slows down the engine just as opening or closing the throttle does on an automobile.

The other common type of injection system also has individual pumps for each cylinder, but they are grouped together in some convenient place on the side of the engine. A separate pipe leads to a spray nozzle in each cylinder. A special camshaft is built in the pumping unit, with a cam for each cylinder pump. This is driven from the crankshaft, at half speed for a four-cycle engine. Its general operation and controls are much the same as those just described for the unit injector, but the injection pressures are much lower.

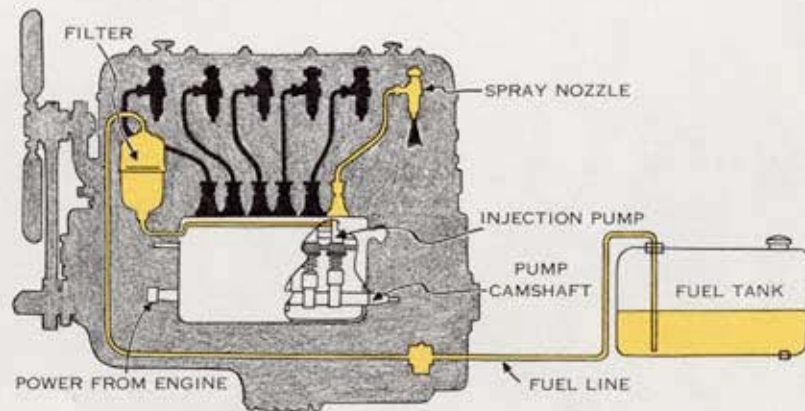

Another type of injection system

What about the fuel itself? There is some confusion in the minds of many people about what will burn satisfactorily in a Diesel engine. The large, slow-running engines used to be very broad in their requirements—heavy fuel oil of almost any grade would be all right. But the high speed engines we are discussing here burn a light fuel—sometimes kerosene—and are just as particular about their fuel as any gasoline engine. Diesel fuel is different from gasoline, but it is just as much “custom-made” to fit the requirements. Poor fuel can mean hard starting, incomplete combustion, smoky exhaust, knock, and such troubles.



One of the most important characteristics is that measured by cetane numbers, which we discussed earlier. This is really a measure of the ease and readiness with which the fuel will ignite in the engine. The higher the cetane number, the less lag there is between the time the fuel enters the cylinder and the time it starts burning. Other things being equal, the higher the cetane number, the better the fuel. The large slow Diesel can use 30 cetane fuel. The high speed Diesels must use at least 45 cetane, with some requiring as high as 60.

Diesel fuel has an advantage over gasoline from the safety standpoint. It does not give off vapor as readily, and therefore does not ordinarily form an explosive air-fuel mixture when spilled or in case of a leak. This is an important advantage, particularly for certain uses where the fire hazard is above the ordinary.



There is, of course, nothing you can point your finger at on a Diesel engine and say, “That is the ignition system.” The oil is

### A POWER PRIMER

ignited because the air has been compressed to the point where it is hot enough to start the oil burning. It is compression ignition. But there are a lot of different ways in which it can burn, and many different arrangements have been tried to make it burn the best way. "Combustion systems" might

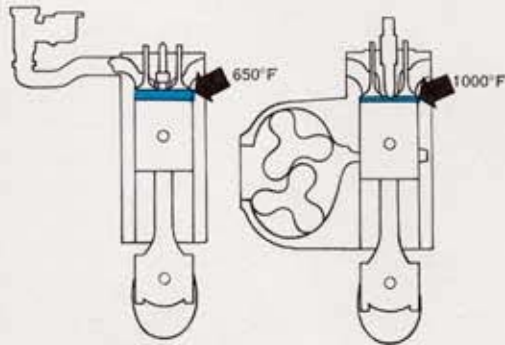

be a better name for these arrangements than "ignition systems."

Diesel fuel, just like gasoline, must be mixed thoroughly with air in order to burn properly. That is why we atomize it as much as possible with the injector when we shoot it into the cylinder. In addition to this, however, we want the air in the cylinder to be moving around fast enough so that all the oil will find some air to join up with, so that enough air will come in contact with the oil. Otherwise all the fuel might not burn completely.

Another important thing is how fast the oil burns. We would like to have the first little bit start burning as soon as possible, and have this in turn ignite the rest in an orderly fashion as it enters the cylinder. What we do not want is to get a lot of fuel in one place and have it burn all at once. The latter gives sudden high pressures, which means more tendency to knock and means that a stronger, heavier engine is necessary. The fuel itself has a lot to do with this, but the combustion system affects it also.

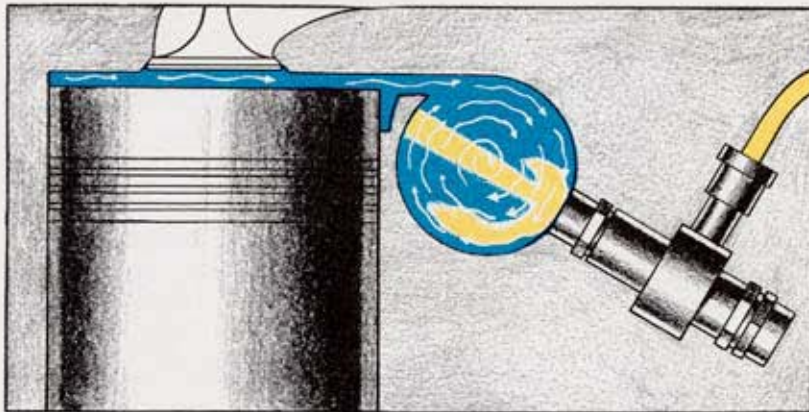

*Pre-combustion chamber*

### DIESEL ENGINE

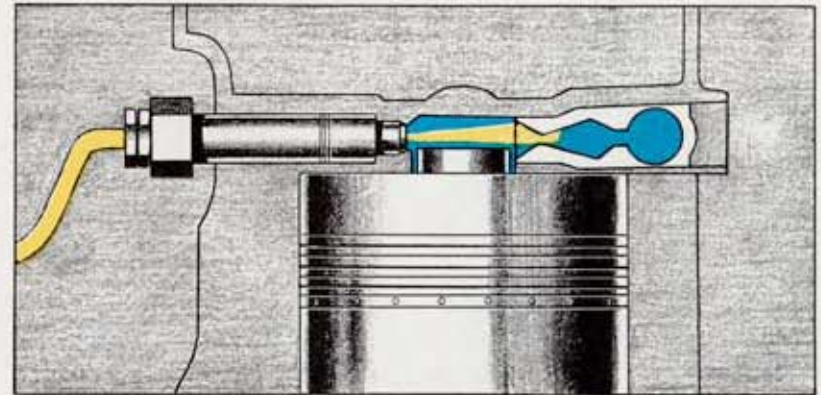

*"Energy Cell"*

So most of the work on combustion systems has been done with these problems in mind.

The combustion system really means the shape of the combustion chamber. But this includes such things as the form of the piston head, the location of the injector, etc. We will not attempt to cover them all, but will show a few general types.

Some engines use pre-combustion chambers, of which there are various designs. We show one here. An auxiliary chamber is located to one side of the top of the cylinder, with a narrow passage between. At the top of its stroke, the piston is almost touching the cylinder head, so practically all the air is in the small chamber. It is pushed in at high speed, so it is whirling around furiously at the moment the oil is injected into it. This turbulence mixes the oil and air thoroughly, and as soon as combustion has started the burning mixture expands out into the main cylinder.

Another type has a so-called "energy cell." The combustion chamber is shaped like a figure 8, with the injector on one side and the cell, or chamber, right opposite it. Part of the spray from the injector ignites in the main cylinder, but some of it goes straight across into the auxiliary chamber. When this starts burning it pushes back into the main combustion space and ignites the last part of the oil spray coming from the injector. This push out of the chamber causes the turbulence helpful to good combustion of the last portion of the charge.

In the two-cycle engine which we have been using as an example in much of this discussion, the injector is straight up and

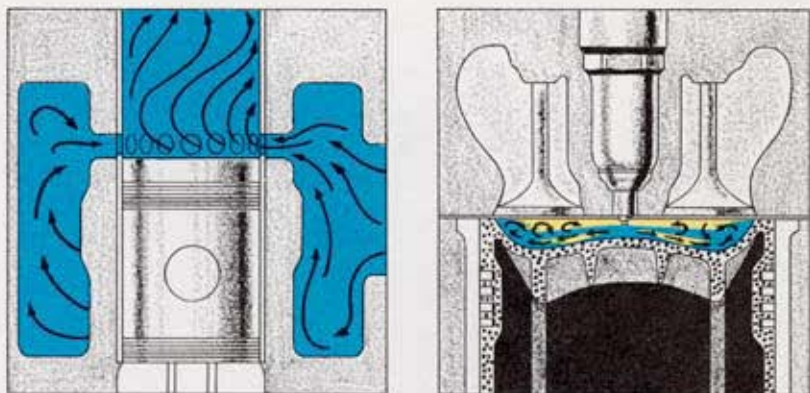

down in the center of the top of the cylinder. There are no auxiliary chambers of any sort. But the top of the piston is hollowed out and shaped to force the air close to the oil spray and the air has been given a whirling motion by the design of the intake ports. In addition we have the extremely high injection pressure which atomizes the oil more completely.

There is one difference between the combustion in a Diesel engine and in a gasoline engine which we have not mentioned. It may have been self-evident, but it is worth pointing out definitely. In a Diesel we do not worry about mixture ratio. It is not necessary to have just 15 parts of air to 1 part of fuel. We practically always have much more air than that. There is no throttle valve. We completely fill the cylinder with air on each stroke, whether we are injecting a small amount of fuel for idling or a full charge for maximum power. If we mixed these amounts of fuel and air outside

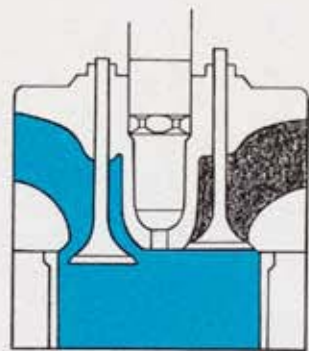

Air

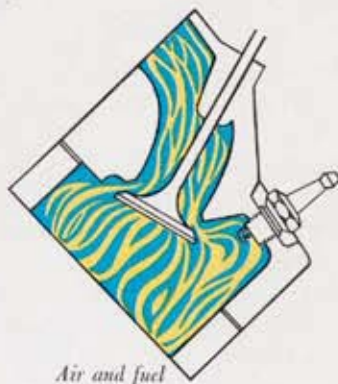

Air and fuel

the cylinder, the mixture would be much too lean to burn. But when we inject the fuel oil into the cylinder, it mixes with just the air it comes in contact with. Each small particle surrounds itself with some air. The first little bit starts to burn as soon as it has enough air, and this fire keeps the combustion going as the rest of the oil spray follows it in. The fact that we always have more than enough air in the cylinder means that we get better fuel economy at part load than we do in a carburetor engine. That is, in a Diesel engine the efficiency does not drop off when it is running at less than full power; in fact it increases. We will not go into the technical reasons for it, but it is worth noting that we get this part load economy in a Diesel in addition to its fundamental higher efficiency due to the higher compression ratio.



We have pointed out a lot of differences between Diesel engines and gasoline carburetor engines. But it might be interesting to see if we can find one basic difference between the two. Is there any one thing which is responsible for it all—which changes the Otto cycle to the Diesel cycle?

If we analyze all the differences and the reasons for making them different, we find that we can trace them back to one thing—high compression ratio.

When we raise the compression ratio of an engine to 16 to 1, we immediately find that we cannot mix the fuel and air together outside the cylinder. We get knock and pre-ignition and all sorts of trouble. We will have to compress the air alone and put the fuel in just when we want it to start burning. This leads us to throw away the carburetor and use an injector in its place. The same thing is true of the electric ignition. We quickly found that we got ignition, without worrying about a spark,

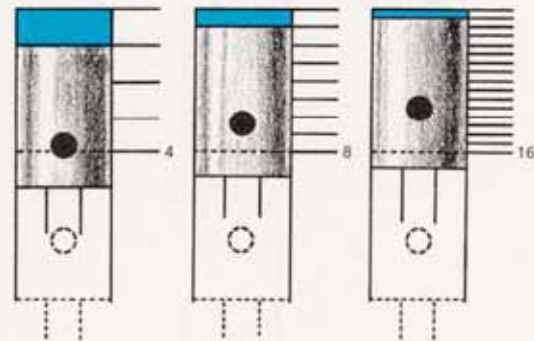

Compression ratios

when we compressed the mixture to 16 to 1. So we throw away the spark plug, distributor, breaker, coil and so forth. The Diesel engine parts are heavier, to withstand the increased pressures due to higher compression. The Diesel engine is more efficient, due directly to its high compression ratio.

Thus every important difference between the two types of engines is because the Diesel has a compression ratio of about 16 to 1 and the gasoline engine has a compression ratio of about 8 to 1.

When we consider future possibilities however, we have to qualify that statement. The compression ratio of gasoline engines has been gradually going up for years, as fast as the octane rating of the gasoline has let it. 4 to 1 not so long ago, recently 8 to 1 has been a common ratio, using fuel with an octane number of 85 to 95. And the scientists talk of fuels way beyond that, which will permit raising the compression even more. So it is easy to see the possibility of two engines of the same compression ratio, one operating on the Otto cycle, the other on the Diesel cycle. The gasoline will not ignite by itself, without a spark, even with that high compression. The Diesel fuel will be improved in the other direction and will ignite instantaneously from the heat of that same compression. So in the long run the actual difference between these two types of engines may be only the difference in their fuels.

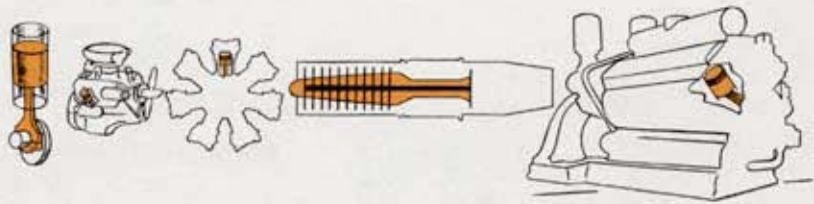

## What is the Best Engine?

**W**E have been discussing a number of different kinds of engines, and one reaction may be, "Why so many different engines? Why not pick the best one and use only that kind?"

Of course one problem is to decide which is the best one. There is nothing easier to start an argument about than that. Diesel or gasoline, air cooled or liquid cooled, in-line, V-type or radial, two-cycle or four-cycle—there are numerous choices to argue about.

But actually there is no argument. There is no "best engine." Each type of engine is used in the service for which it is best suited. The fact that we have so many different varieties, that we can keep on building and selling them, seems to indicate that there is a place for all of them. For after all, the customer is boss, and if he stops buying one kind of engine it doesn't last long.

What about the engines of the future? We don't know what kind they will be, but they will be better than those of today. We don't know just how they will differ, but we do know they will be improved in many ways. Maybe they will use atomic power. Maybe they will get their energy direct from the sun. But for the next few years at least, the chances are that the engines we will see and use will be internal combustion engines of one sort or another, and will depend on AIR, FUEL, and IGNITION for their operation.

