

# 2011 Tucson



 **HYUNDAI™**



# 2011 Tucson

## A BOLD STATEMENT IN STYLE.

Hyundai's compact CUV, the 2011 Tucson, enters with a modern design that instantly sets it apart as the most distinctive, visually appealing vehicle in its class.

The first design to be conceived and engineered at Hyundai's new design centre in Frankfurt, the Tucson makes a bold statement about itself and those who drive it.

With sleek, modern styling and highly efficient drive-trains, we've done no less than change the game for CUVs. Explore the 2011 Tucson today.

Our investment in eco-friendly technologies, quality craftsmanship, extensive research and design, together with

our state-of-the-art facilities and dedicated human resources, ensures our vehicles are built with integrity from the first to the final detail. And, together, they deliver on Hyundai's promise to Canadians – to create a lineup of smart vehicles.



 HYUNDAI™



# exterior



**Let the Sun Shine In.** Catch the rays or shooting stars with Hyundai's first panoramic sunroof (standard on Limited models). It features a fixed glass roof section at back and a traditional pop-up/slide section at front, with UV blocking all over.

**Add Allure with Alloys.** The 2011 Tucson L & GL come standard with 17-inch steel wheels and attractive metallic covers. For a sportier look, 17" 10-spoke alloys are standard equipment on GLS, with aggressive 18" 10-spoke alloys standard on Limited models.

**An Antidote to Boring Design.** The 2011 Tucson is an exhilarating exercise in design. Its fluidic, assertive, sporty lines stem from a deliberate desire to set it apart in a world of me-too CUVs. A sleek window line begins at the side-view mirrors, rising back to meet the line of the roof-extending rear spoiler. Sculptured hood creases reach down from the steeply raked windshield (for lowered cabin noise) to the hexagonal grille, then stretch back through the double-set shoulder lines, extending from headlight to tail light. Styling details – such as the roof-mounted antenna, wrap-around tail lights and side sill moulding – complete the overall impression of an athletic, lean, solid performer.



# interior



### **Convenient Touch-Screen Navigation.**

Get where you're going with concise maps and directions thanks to an available touch-screen navigation system<sup>o</sup> with rear-view camera. This 6.5" high-resolution LCD system helps you find your way, while making it safer and easier to back up (Limited with Nav. model).

### **The Safety of Bluetooth® Handsfree<sup>o</sup>.**

The 2011 Tucson helps you make safer driving a priority with available Bluetooth® Handsfree<sup>o</sup> Phone System and steering wheel-mounted Bluetooth® controls.

**A Look That Inspires Adventure.** When you've raised the bar so high on exterior design, you know the 2011 Tucson's interior will be something special. Again, design and style are paramount, from the bold 4-spoke steering wheel and X-design dashboard up front – drawing lines from the driver and passenger sides through the centre stack controls – to the spacious 728 litres of cargo space at back. Tucson's intelligent design is safer, too. A solid, organ-style accelerator pedal improves comfort and ensures that nothing can get beneath it, while available steering wheel audio controls let you control the music without taking your hands off the wheel. An innovative one-touch triple turn signal makes it easier to alert other drivers during lane changes and in parking lots.

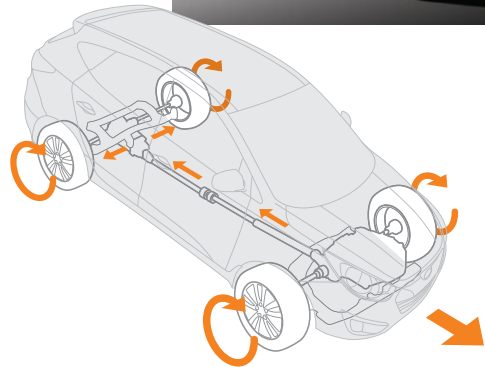

**Responsive Handling and Ride.** The Tucson was designed in Europe and its handling and suspension show their heritage. Motor-driven power steering provides responsive handling and fuel savings, while the independent suspension offers agility and a firm ride.

**All-Wheel Drive.** The optional advanced electronic on-demand AWD system with driver-selectable lock delivers a 50/50 torque split to the front and rear wheels for traction in unpredictable conditions.

performance



**A New Standard In Efficiency.** The 2011 Tucson's performance and efficiency are no less revolutionary than its design. The Tucson comes equipped with either a 2.0L (165 HP) or 2.4L (176 HP) 4-cylinder engine, both maximizing power while providing impressive fuel efficiency. What's more, the engines are mated to a 5-speed manual transmission (standard on L) or an optional 6-speed automatic with SHIFTRONIC™. Helping with fuel economy are Tucson's silica tires. Their unique compound provides fuel-saving low-rolling resistance combined with increased grip and improved wear performance. And Tucson's standard Eco-Indicator helps drivers increase their own efficiency by suggesting optimum shift points (manual transmission) and providing driving style feedback (automatic transmission).



s a f e t y



**Airbag Protection All Around.** Every Tucson is equipped with six airbags, including dual front airbags<sup>1</sup>, dual front seat-mounted side-impact airbags, and two side-curtain airbags for front and outboard rear passengers which are equipped with rollover sensors to ensure they remain inflated during a rollover.

**Active Head Restraints.** Standard on the Tucson are front active head restraints. In the event of a rear-end collision, the restraints move forward before your head moves back, providing added protection against whiplash. As well, adjustable head restraints – and 3-point seatbelts – are standard on all seating positions.

**Don't Take Chances with Safety.** The 2011 Tucson's standard safety features are proof of Hyundai's commitment to putting you first. Hyundai's innovative Hillstart Assist Control – to minimize backroll on steep ascents – and Downhill Brake Control – to maintain vehicle control and speed on steep descents – both give you greater control and safety and come standard on every Tucson. Also standard are an Anti-lock Braking System with Electronic Brake Force Distribution and Brake Assist plus Electronic Stability Control and Traction Control System<sup>2</sup> – technologies that help you control the vehicle in adverse conditions.



# 2011 Tucson

Stepping into a beautifully-designed  
generously-appointed interior,  
where form greets function.



## SMART, AND WHAT IT MEANS TO US.

Every automaker – like every person – has a philosophy that guides their thinking and decisions. Ours is straightforward and pragmatic: to be smart. At Hyundai, we try to make smart moves, every day, so we're not only your next vehicle choice, but also your choice again and again down the road.

**Smart is** building vehicles that offer exceptional value – not just a great price. We build vehicles that people are happy to drive, with the comfort and safety features they want, and meaningful warranties to back them up.

**Smart is** the drive to zero defects. In 1999, we embarked on our quality mission when we launched the Zero Defects program. This initiative involves everyone and every aspect of the company's culture in a sincere commitment to quality manufacturing across the board. While we continue to be honoured with awards for excellence, our priority remains our unwavering commitment to our drivers.

**Smart is** offering sensible prices on vehicles that people are happy to drive. And we want you to be as happy with your vehicle in five or ten years as you are on day one. This means building a quality product, and equipping it with the kinds of features that make driving a joy.

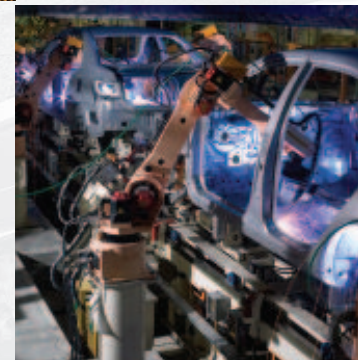





It also means offering a warranty that's meaningful, like a 5-year/100,000 km Comprehensive Limited Warranty<sup>†</sup>, 5-year/100,000 km Powertrain Warranty and 3-year/Unlimited km Roadside Assistance Program<sup>††</sup>.

Ultimately, smart is taking a leadership role, with the courage to break new ground and chart the course that an entire industry will take. It requires the confidence to guide others, and the conviction to follow through on commitments. Hyundai's commitment to these principles has propelled us to being the world's 4<sup>th</sup> largest auto manufacturer, servicing 160 countries and selling 30 million vehicles.

As part of our leadership role, we've launched Blue Drive, a collection of environmental initiatives that will help the fight to reduce greenhouse gas emissions. It's one of many steps toward our goal to achieve the most fuel-efficient lineup on the planet by 2015, and just another way we're working to be your first choice in vehicles today, and again down the road.

We believe that if we continue to follow the principles behind what is smart, we'll continue to show Canadians that Hyundai is the right choice today and their best choice for the future.



# colours

## 2011 Tucson

Our vivid palette of exterior colours is the perfect way to complete your Tucson.  
Explore the options and choose the one that best reflects your personal style.

### EXTERIOR



Cotton White

A C E

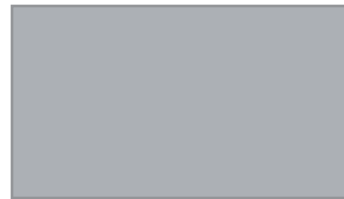

Graphite Grey

A C E

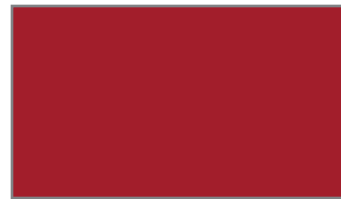

Garnet Red

B D F



Chai Bronze

A C E



Ash Black

A C E



Blue Ice

A C E



Iris Blue

A C E

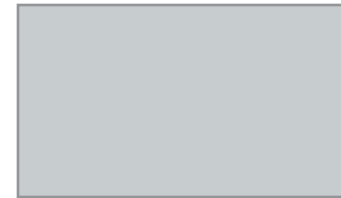

Diamond Silver

A C E

### INTERIOR



Black Cloth

A



Taupe Cloth

B



Black Cloth/Leather

C

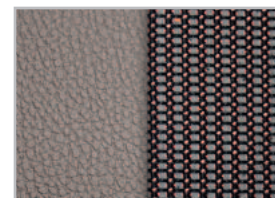

Taupe Cloth/Leather

D



Black Leather

E

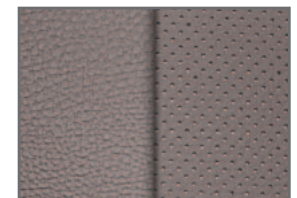

Taupe Leather

F



# a c c e s s o r i e s

## 2011 Tucson

Hyundai is making its name on delivering unprecedented quality and value – offering Canadians a wide variety of lifestyle-friendly vehicles loaded with outstanding packages of standard features and premium extras. Individual needs call for individual solutions. That's why Hyundai goes out of its way to offer you a line of accessories designed to suit specific demands. With Hyundai's line of authorized parts and accessories, you are able to customize and adapt your vehicle to your lifestyle.



**Rubber Floor Mats.** Protect the interior of your Hyundai from everyday dirt and debris with custom-made floor mats.



**Trailer Hitch Kit.** Designed to meet all your towing needs, a Hyundai hitch can accommodate a wide variety of hitch-mounted accessories. Kit includes the trailer hitch, ball mount and end cap. Chrome ball shown not included.



**Side Visors.** New style side visors, install easily in the window channel with no unsightly exterior tape. Helps keep the elements out of the vehicle's interior including snow and rain.



**Running Boards.** Getting in and out of your vehicle is easy with a set of durable running boards.



**Front Bumper Guard.** Add style to your vehicle and protect the front bumper with a polished stainless steel bumper guard.



**Rear Bumper Guard.** Add a rugged dimension to your Hyundai with a durable polished stainless steel rear bumper guard.



**Mud Guards.** Custom-fit mud guards keep the dirt and debris of everyday driving where it belongs.



**Side Steps.** Stylish and functional, polished stainless steel side steps will add a rugged look to your vehicle.

**L** *Standard Equipment Includes:*

- 2.0L Theta II 165 hp 16-valve DOHC 4-cylinder Engine with Dual Continuously Variable Valve Timing (CVT)
- 17" Steel Wheels with Covers
- 4-wheel Disc Brakes
- 5-speed Manual Transmission
- 60/40 Split Fold-down Rear Seatback with Adjustable Headrests
- Air Conditioning with Manual Temperature Controls
- Airbags<sup>1</sup>: Dual Front Airbags, 2 Seat-mounted Side-impact, 2 Roof-mounted Side Curtains with Rollover Sensor
- AM/FM/CD/MP3/Aux./USB/iPod Plug Audio System with Six Speakers
- Anti-lock Braking System (ABS) with Electronic Brake Force Distribution (EBD) and Brake Assist (BA)
- Cloth Seats and Interior Trim
- Downhill Brake Control (DBC) and Hillstart Assist Control (HAC)
- Power Windows with Driver's Auto-down
- Rear Spoiler
- Rear Window Washer/Wiper
- Optional: 6-speed Automatic Transmission with Remote Keyless Entry with Alarm

**GL** *Includes Tucson L Standard Equipment Plus:*

- 2.4L Theta II 176 hp 16-valve DOHC 4-cylinder Engine with Dual Continuously Variable Valve Timing (CVT)
- 6-speed Automatic Transmission with OD Lockup Torque Converter with SHIFTRONIC™ Manual Shift Mode and Cruise Control
- Bluetooth® Handsfree<sup>3</sup> Phone System
- Remote Keyless Entry with Alarm
- Steering Wheel Mounted Audio Controls
- Optional: All-wheel Drive

**GLS** *Includes Tucson GL Standard Equipment Plus:*

- 17" 10-Spoke Aluminum Alloy Wheels
- AM/FM/XM/CD/MP3/Aux./USB/iPod Plug Audio System with Six Speakers
- Body Colour Exterior Mirrors, Door & Rear Liftgate Handles
- Fog Lights and Windshield Wiper De-icer
- Roof Rails and Rear Privacy Glass
- Cloth Seats with Leatherette Bolsters and Heated Front Seats
- Leather Wrapped Telescopic Steering Wheel
- Optional: All-wheel drive

**Limited** *Includes GLS Equipment Plus:*

- 18" 10-spoke Aluminum Alloy Wheels
- Air Conditioning with Dual-zone Automatic Temperature Controls and Cleanair Ionizer
- All-wheel Drive
- Automatic Light Control
- Chrome-accented Grille with Black Lower Air Intake
- Chrome Door Handles
- Electro-chromic Auto-dimming Rearview Mirror with HomeLink®
- Exterior Mirror Integrated Side Repeaters
- Outside Temperature Display
- Panoramic Sunroof
- Power Windows with Driver Auto-up/down with Pinch Protection
- Driver's Power-adjustable Seat with Lumbar Seats and Leather Support
- Solar Control Glass
- Excludes: Roof Rails

**Limited with Nav.** *Includes Limited Equipment Plus:*

- AM/FM/XM/CD/MP3/Aux./USB/iPod Plug Audio System with Amplifier and Subwoofer
- High-resolution Touch-screen Navigation System<sup>6</sup>
- Rearview Camera

**Mechanical**

Engine Type	In-line 4-cylinder with 16-valve DOHC and Dual CVT	S	S	S	S	S
Displacement	2.0L (1,988 cc)	S	-	-	-	-
	2.4L (2,359 cc)	-	S	S	S	S
Bore and Stroke (mm)	86.0 x 86.0	S	-	-	-	-
	88.0 x 97.0	-	S	S	S	S
Horsepower @ RPM	165 @ 6,200	S	-	-	-	-
	176 @ 6,000	-	S	S	S	S
Torque (lb-ft) @ RPM	146 @ 4,600	S	-	-	-	-
	168 @ 4,000	-	S	S	S	S
Drivetrain	FWD	S	S	S	-	-
	AWD	-	0	0	S	S
Exhaust	Single	S	S	S	S	S
Brakes	Front: Power-assisted Ventilated Discs	S	S	S	S	S
	Rear: Power-assisted Solid Discs	S	S	S	S	S
	Anti-lock Braking System (ABS) with Electronic Brake Force Distribution (EBD) and Brake Assist (BA)	S	S	S	S	S
Suspension	Front: MacPherson Struts with Coil Springs and Stabilizer Bar (Amplitude Selective Damper*)	S	S	S	S*	S*
	Rear: Multi-link with Stabilizer Bar and Gas Shock Absorbers (ASD*)	S	S	S	S*	S*
Tires	P225/60R17	S	S	S	-	-
	P225/55R18	-	-	-	S	S
Steering	Motor-Driven Power Steering	S	S	S	S	S
Wheels	17" x 6.5J Steel with Wheel Cover	S	S	-	-	-
	17" x 6.5J Aluminum Alloy	-	-	S	-	-
	18" x 6.5J Aluminum Alloy	-	-	-	S	S
Electrical System	Battery 12V, 54AH	S	S	S	S	S
Frame Construction	Unitized Body	S	S	S	S	S
Turning Diameter	15.9	S	S	S	S	S

**Dimensions mm**

Length	4,400	S	S	S	S	S
Width (excludes Mirrors)	1,820	S	S	S	S	S
Height (without Roof Rails)	1,655/1,685	S	S	S	S	S
Wheelbase	2,640	S	S	S	S	S
Track Width (Front/Rear)	1,591/1,592	S	S	S	S	S
Head Room (Front/Rear)	1,000/994	S	S	S	S	S
Leg Room (Front/Rear)	1,047/982	S	S	S	S	S
Shoulder Room (Front/Rear)	1,450/1,400	S	S	S	S	S
Hip Room (Front/Rear)	1,410/1,356	S	S	S	S	S

**Fuel Tank Capacity Litres**

	55
--	----

**Fuel Consumption Rating<sup>4</sup> (L/100 km)**

City/Highway					
5-speed Manual Transmission (FWD) (2.0L)	10.1/7.4	S	-	-	-
6-speed Automatic Transmission (FWD) (2.0L)	9.1/6.5	0	-	-	-
6-speed Automatic Transmission (FWD) (2.4L)	9.5/6.3	-	S	S	-
6-speed Automatic Transmission (AWD) (2.4L)	10.1/7.1	-	-	-	S

**Towing Capacity (kg)**

With Trailer Brake:	907	S	S	S	S	S
Without Trailer Brake:	454	S	S	S	S	S

**Curb Weight (kg)**

5-speed Manual transmission (FWD) (2.0L)	1,424/-	S	-	-	-	-
6-speed Automatic transmission (FWD) (2.0L)	1,440/-	0	-	-	-	-
6-speed Automatic transmission (FWD/AWD) (2.4L)	1,452-1,529/1,505-1,582	-	S	S	S	S



		L	GL	GLS	LIMITED	LIMITED Nav. Pkg.
<b>Interior</b>						
Air Conditioning	Manual Temperature Control	S	S	S	-	-
	Dual-zone Fully Automatic with Cleanair Ionizer	-	-	-	S	S
Audio System	AM/FM/CD/MP3/Aux./USB/iPod Plug with Six Speakers	S	S	-	-	-
	AM/FM/XM/CD/MP3/Aux./USB/iPod Plug with Six Speakers	-	-	S	S	-
	AM/FM/XM/CD/MP3/Aux./USB/iPod Plug with Amplifier and Subwoofer	-	-	-	-	S
Carpet	Deluxe Cut-pile	S	S	S	S	S
Clock	Digital	S	S	S	S	S
Defogger	Front Side Windows	S	S	S	S	S
Defroster	Rear Window, Electronic with Timer	S	S	S	S	S
Door Trim	PVC	S	S	-	-	-
	Artificial Leather	-	-	S	S	S
Gauges	Speedometer, Tachometer, Trip Odometer, Fuel, Coolant Temp.	S	S	S	S	S
Glove Box	Lockable, Illuminated*	S	S	S*	S*	S*
Illumination	Map Lights, Ashtray, Glove Box*, Overhead Centre Light	S	S	S*	S*	S*
Mirrors	Driver and Front Passenger Vanity	S	S	S	S	S
	Inside Rearview, Manual Day/Night	S	S	S	S	S
Outside Temperature Display		-	-	-	S	S
Power Door Locks		S	S	S	S	S
Power Windows	Driver's Auto-down	S	S	S	-	-
	Driver's Auto-up/down with Pinch Protection	-	-	-	S	S
Remote Releases	Fuel Filler Door	S	S	S	S	S
	Hood	S	S	S	S	S
Seats	Front Buckets with Adjustable Active Head Restraints	S	S	S	S	S
	Driver's 6-way Adjustable	S	S	S	-	-
	Driver's 8-way Power-adjustable with Power Lumbar Support	-	-	-	S	S
	60/40 Split Fold-down Rear Seatback with Adjustable Head Restraints	S	S	S	S	S
	Centre Armrest with Dual Cupholder	S	S	S	S	S
Seat Trim	Cloth	S	S	-	-	-
	Cloth Insert with Leatherette Bolster	-	-	S	-	-
	Leather	-	-	-	S	S
Steering Wheel	Mounted Audio and Bluetooth® Handsfree <sup>◇</sup> Controls	-	S	S	S	S
	Leather-wrapped	-	-	S	S	S
	Tilting	S	S	S	S	S
	Telescoping	-	-	S	S	S
Trip Computer		S	S	S	S	S
<b>Convenience</b>						
Bluetooth® Handsfree <sup>◇</sup> Phone System		-	S	S	S	S
Console	Overhead Sunglass Storage	S	S	S	S	S
	Fixed Armrest Storage Box	S	S	S	S	S
Cruise Control		-	S	S	S	S
Cupholders	Dual Front Centre Console-mounted	S	S	S	S	S
DC Power Outlet (12V)	Front Centre Console (2), Rear Cargo Area (1)	S	S	S	S	S
Navigation System <sup>◇</sup>	6.5" High-resolution Touch-screen Display with Rearview Camera	-	-	-	-	S
Rear Centre Armrest with Dual Cupholders		S	S	S	S	S
Seats	Heated Front Seats	-	-	S	S	S
	Seatback Pockets	S	S	S	S	S

Specifications, features, illustrations, accessories, materials and equipment and all other information shown in this brochure are based on the latest information available at the time of publication. Although descriptions are believed to be correct, accuracy cannot be guaranteed. Hyundai Auto Canada Corp. reserves the right to make any changes or modifications at any time, without notice or obligation, including, without limitation, in colour, specifications, features, accessories, materials, equipment and models. Some vehicles are shown with optional equipment. All Hyundai warranties have no deductible.

^ Fuel economy figures are based on manufacturer's testing and are used for comparison purposes only. Actual fuel efficiency may vary based on driving conditions and the addition of certain vehicle accessories.

† Hyundai's Comprehensive Limited Warranty coverage covers most vehicle components against defects in workmanship under normal use and maintenance conditions.

†† Includes fuel delivery service, flat tire changing, lock-out service, towing service and more. Just one toll-free call away. 24 hours a day.

		L	GL	GLS	LIMITED	LIMITED Nav. Pkg.
<b>Exterior</b>						
Antenna	Roof-mounted with AM/FM Reception	S	S	-	-	-
	Roof-mounted with AM/FM/XM Reception	-	-	S	S	S
Fog Lights		-	-	S	S	S
Front Grille	Black/Body Colour	S	S	-	-	-
	Black/Body Colour with Chrome Accents	-	-	-	S	S
Glass	Tinted	S	S	S	S	S
Headlights	Multi-reflector with Escort Feature	S	S	S	S	S
	Automatic Light Control	-	-	-	S	S
Outside Mirrors	Black Dual Power-adjustable, Heated with Timer	S	S	-	-	-
	Body Colour, Dual Power-adjustable, Heated with Timer	-	-	S	S	S
Panoramic Sunroof	One-touch Open with Dual Shade	-	-	-	S	S
Privacy Glass	Rear/Quarter/Back	-	-	S	S	S
Rear Spoiler	Integrated with HMSL, Body Colour	S	S	S	S	S
Roof Rails		-	-	S	-	-
Solar Control Glass	Front Door and Windshield	-	-	-	S	S
Wipers	Front 2-speed/Variable Intermittent	S	S	S	S	S
	Front Window Wiper De-icer	-	-	S	S	S
	Rear Wiper/Washer	S	S	S	S	S
<b>Safety</b>						
Active Head Restraints	Front Seats	S	S	S	S	S
Airbags <sup>1</sup>	Advanced Driver and Front Passenger Occupancy Classification Sensor (OCS)	S	S	S	S	S
	Driver and Front Passenger Side-impact (Thorax)	S	S	S	S	S
	Side Air Curtains (Front and Rear with Rollover Sensors)	S	S	S	S	S
Alarm System		0	S	S	S	S
Assist Grips	Four	S	S	S	S	S
Brakes	Anti-lock Braking System (ABS) with Electronic Brake Force Distribution (EBD) and Brake Assist (BA)	S	S	S	S	S
Child Safety	Child-proof Rear Door Locks	S	S	S	S	S
	Child-seat LATCH System	S	S	S	S	S
Door Locks	Remote Keyless Entry with Alarm and Panic	0	S	S	S	S
Electronic Stability Control (ESC) with Traction Control System (TCS) <sup>2</sup>		S	S	S	S	S
Ignition Immobilization System**		S	S	S	S	S
Restraint Systems	Front: 3-point Seatbelt with Adjustable Shoulder Belt Height	S	S	S	S	S
	Rear: 3-point Seatbelt	S	S	S	S	S
Steering Column	Energy-absorbing	S	S	S	S	S
Steering Wheel Lock	When Key is Removed	S	S	S	S	S
Warning Lights	Door Ajar, Liftgate Ajar, ABS, ESC Off, Oil Pressure, Charging System, EPS Low Fuel, Airbag (SRS), Check Engine, Temperature, Immobilizer, Seatbelt	S	S	S	S	S
<b>Standard Warranty</b>						
Coverage	One of Canada's best warranties					
	5-year/100,000 km Comprehensive Limited Warranty <sup>†</sup>	S	S	S	S	S
	5-year/100,000 km Powertrain Warranty	S	S	S	S	S
	3-year/Unlimited km Roadside Assistance Program <sup>††</sup>	S	S	S	S	S
0 = Optional	S = Standard	- = Not Available				

1 The Supplemental Restraint (Airbag) System (SRS) is designed to work with the 3-point seatbelt system. The SRS deploys in certain frontal and/or side-impact conditions where significant injury is likely. The SRS is not a substitute for seatbelts, which must still be worn at all times. Children under the age of 13 should be securely restrained in the rear seat. NEVER place a child-seat in the front seat of a Hyundai vehicle.

2 Electronic Stability Control (ESC) and Traction Control System (TCS) are meant to enhance conscientious driving habits and are not a substitute for safe driving practices.

\*\* CAN/ULC S338-98 compliant immobilizer may reduce insurance costs in some instances.

™ The Hyundai name, logo, product names, feature names, images and slogans are trade marks owned by Hyundai Auto Canada Corp.

◇ When equipped with optional navigation package, Bluetooth® Handsfree and the navigation system only recognize English voice commands.

Bluetooth® word mark and logos are registered trademarks owned by Bluetooth SIG, Inc., and any use of such marks by Hyundai is under license.

The XM name and logos are registered trademarks of XM Satellite Radio Inc.

## SMART IS IN.

At Hyundai Auto Canada, we believe our customers' needs come first. That's why we've invested billions of dollars worldwide in research, design, safety, testing and manufacturing. And with numerous third-party awards for quality, reliability and value, we can't help but be proud. But in the end, it's still about you, our customer. Simply put, we're committed to over-delivering on all your expectations so we can bring you the vehicle you need, as well as the vehicle you want.

[hyundaicanada.com](http://hyundaicanada.com)

