



TRIBECA | 2008



The pleasure of driving.

It's what makes a Subaru, a Subaru.

The movement began in Japan more than 35 years ago. The driving force: The radical notion – shared by a core group of engineers at Subaru – that a horizontally-opposed engine connected to an All-Wheel Drive (AWD) system could provide more grip, control, safety and sheer driving pleasure on virtually any road in any weather. The decision then came to test this revolutionary thinking in the toughest arena known to man or machine, the FIA World Rally Championship. Wins followed, then championships. More importantly, though, technological refinements made their way directly from the rally car to the Subaru passenger vehicle lineup. These refinements, to this very day, continue to make a Subaru, a Subaru – one of the safest, most capable and most enjoyable vehicles on the road.

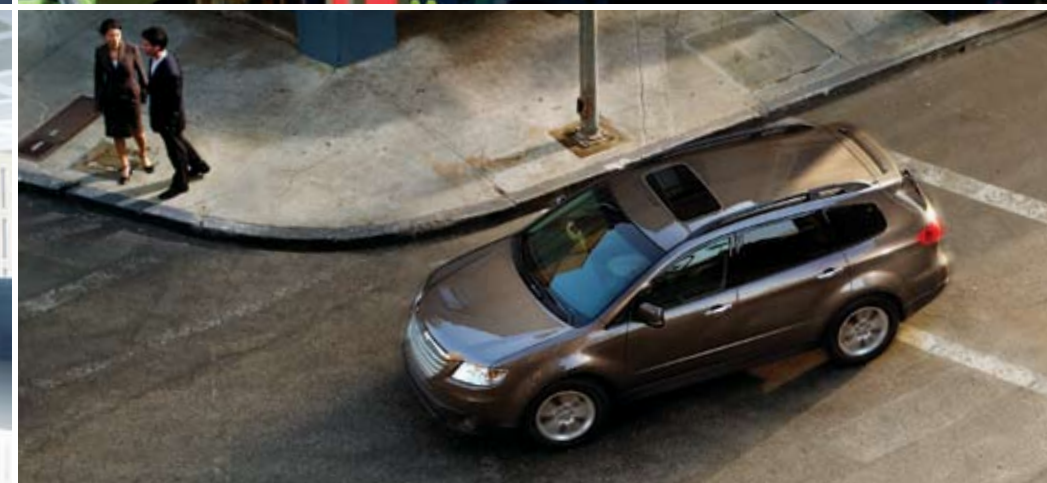



everything you wanted
in an **SUV** and **more**

It completes your SUV wish list.

From its restyled exterior alone – stronger and bolder, yet more graceful – you might not know that the 2008 Subaru Tribeca offers pure excitement behind the wheel. Peel back the elegant packaging, though, and this dynamic SUV reveals itself. Exceptional handling in all conditions courtesy of Subaru symmetrical full-time AWD. Award-winning levels of active and passive safety. The thrill of its SUBARU BOXER engine: powerful, efficient, exhilarating. Add to this list a luxurious and highly versatile interior and you quickly realize that you can have an SUV that has it all.



Do more with more.

The Subaru Tribeca is tailor-made for the discerning driver with a lot on the go. For 2008, this luxurious SUV comes standard with an all-new, more powerful 3.6L SUBARU BOXER engine and enhancements throughout. The base model is generously equipped (heated front seats, moonroof, HID headlights). The Limited Package is even more refined, courtesy of leather upholstery. And the Premier Package, which seats up to seven, adds those great little extras (navigation system, rear-seat DVD entertainment). (Nice.)



Moonroof

Foldable, heated mirrors
with LED turn signals

HID headlights





Inspired design, momentous result.

The 2008 Subaru Tribeca features an award-winning* interior characterized by state-of-the-art design and luxurious materials. The cabin is elegant, immaculately equipped and spacious. Its 4,015 litres of interior space can be accessed via 64 different seating and cargo configurations, a task made easy by the 40/20/40-split flat-folding second row and available 50/50-split flat-folding third row.

The Subaru Tribeca: proof positive that inspired design can be a powerful force.

◀ Tribeca (Premier Package)



2,106 L of available cargo space (seats folded flat)

*wardsauto.com (June 2006)



The finer things.

The 2008 Subaru Tribeca is designed to please even the most discriminating passengers and this philosophy extends to the many luxurious amenities that are available. Whether your objective is to be more entertained, more connected or more comfortable, you'll find precisely what you're looking for right here.

GPS navigation

Getting lost in the Tribeca is half the fun. But when you need to find your way home again, the available touch-screen GPS navigation system (DVD-based) is ready and waiting with a large screen and clear, step-by-step instructions.



Rear vision camera

When reverse is selected, the available rear vision camera is automatically activated and a clear, colour image appears on the navigation screen to aid visibility and ease of parking.



Rear seat DVD entertainment system

This available rear-seat DVD entertainment system features a bright, 9-inch wide screen, individual wireless headphones*, audio/video auxiliary input for video game consoles and a remote control. When you're parked, the DVD plays on the front navigation screen as well. Say 'goodbye' to the drive-in!



Premium audio system

This available system definitely fits the "premium" description. With a 6-CD changer, 4 speakers, 4 tweeters, a subwoofer, audio auxiliary jack, MP3 and WMA compatibility, and pre-wiring for both XM® and SIRIUS® Satellite Radio, this system has it all.

XM® Satellite Radio is standard with Premier Package. (factory installed/subscription required)

Climate control

Introducing comfort and convenience with the push of a button. The Tribeca features automatic dual-zone climate control and a separate cooling unit for rear-seat passengers. Now everyone can keep a cool head and have warm thoughts at the same time.

Power-adjustable seating

Those long drives in the country just became a lot more pleasurable. The driver and front-seat passenger will revel in the comfort of heated, power-adjustable seats. The front passenger's seat is 4-way adjustable, while the driver's seat is 8-way adjustable and also features an available two-position memory function.



*Two sets of headphones are standard. More available as an accessory.

Not all features shown are standard on all models. See specifications for availability.

Built for your driving pleasure.

It's what makes a Subaru, a Subaru.

Technology for technology's sake is hardly the most direct route from A to B, where B = sheer driving pleasure. On the other hand, the advanced thinking behind the Subaru symmetrical full-time All-Wheel Drive (AWD) system was honed in FIA World Rally Championship (WRC) competition for three clear-cut reasons: To prove it was the best AWD system in the world, to give every Subaru driver the control and confidence to tackle any driving challenge, and to create exhilarating dynamic handling. The SUBARU BOXER engine, in its own right, has enjoyed a similar baptism by fire. Fine-tuned on the toughest rally stages in existence – from the snow-covered roads of Sweden to the gravel paths of Corsica – this smooth operator gives the entire line of Subaru vehicles a performance heritage that few can approach.





SYMMETRICAL AWD

Strike a balance, get a grip, take control. For the past 35 years, this has been the core philosophy behind the development of every Subaru vehicle. In that time, our engineers have perfected a combination unique to the industry: the SUBARU BOXER engine and the linear drivetrain layout known as the Subaru symmetrical full-time All-Wheel Drive (AWD) system. In this layout, all drivetrain components – the engine, transmission, driveshaft, and front and rear differentials – are logically aligned close to the centre point of the vehicle. This gives every Subaru heightened stability and excellent weight distribution, front to rear and side to side. Why is Subaru symmetrical full-time AWD a better solution? Simply: balance, grip, control.

SUBARU BOXER

The horizontally-opposed engine, also known as the *boxer*, is so named because its pistons move like a prize-fighter, alternately throwing left and right punches along a horizontal plane. The motion of the left bank of pistons counteracts that of the right, thereby balancing each other out and reducing engine vibration. With respect to the SUBARU BOXER, this intrinsically smooth design is also more compact and sits low in the engine compartment. Net benefits: seamless power delivery and a lower centre of gravity, which help the AWD and 4-wheel independent suspension systems operate at peak efficiency. To further enhance durability, handling and directional stability, every engine is constructed of lightweight, high-strength aluminum.



Three distinct advantages.

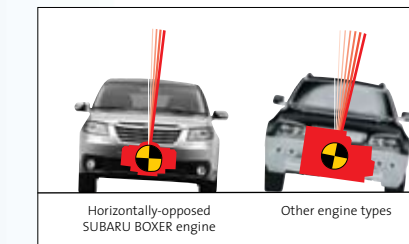

Better balance

When cornering, centrifugal force causes a vehicle to lean and how much it leans depends in part on the vehicle's centre of gravity. Due to the placement of its compact SUBARU BOXER engine, all Subaru vehicles have an exceptionally low centre of gravity. This translates into reduced body roll, along with improved handling and stability, without the need for an overly stiff suspension. This also means that the Subaru Tribeca is more planted than the average SUV during cornering and when quick, evasive manoeuvres are necessary.

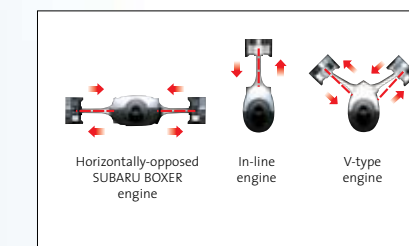

Less vibration

With its 180-degree, horizontally-opposed configuration, the SUBARU BOXER engine design cuts vibration dramatically by eliminating the inertia of opposing pistons as found in V-shaped or in-line configuration engines. The result is excellent responsiveness throughout the rev range, unprecedented driving comfort, greatly improved vehicle stability and a quieter cabin.

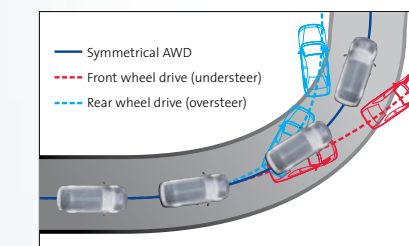

Greater grip

When power is delivered through either the front or the rear wheels, lateral forces will tend to make the vehicle understeer or oversteer while cornering; this, in turn, can lead to instability. With Subaru's symmetrical full-time AWD system, however, power is sent through all four wheels, the vehicle steers naturally and neutrally in the direction of the turn, and precise, controlled handling is maintained.

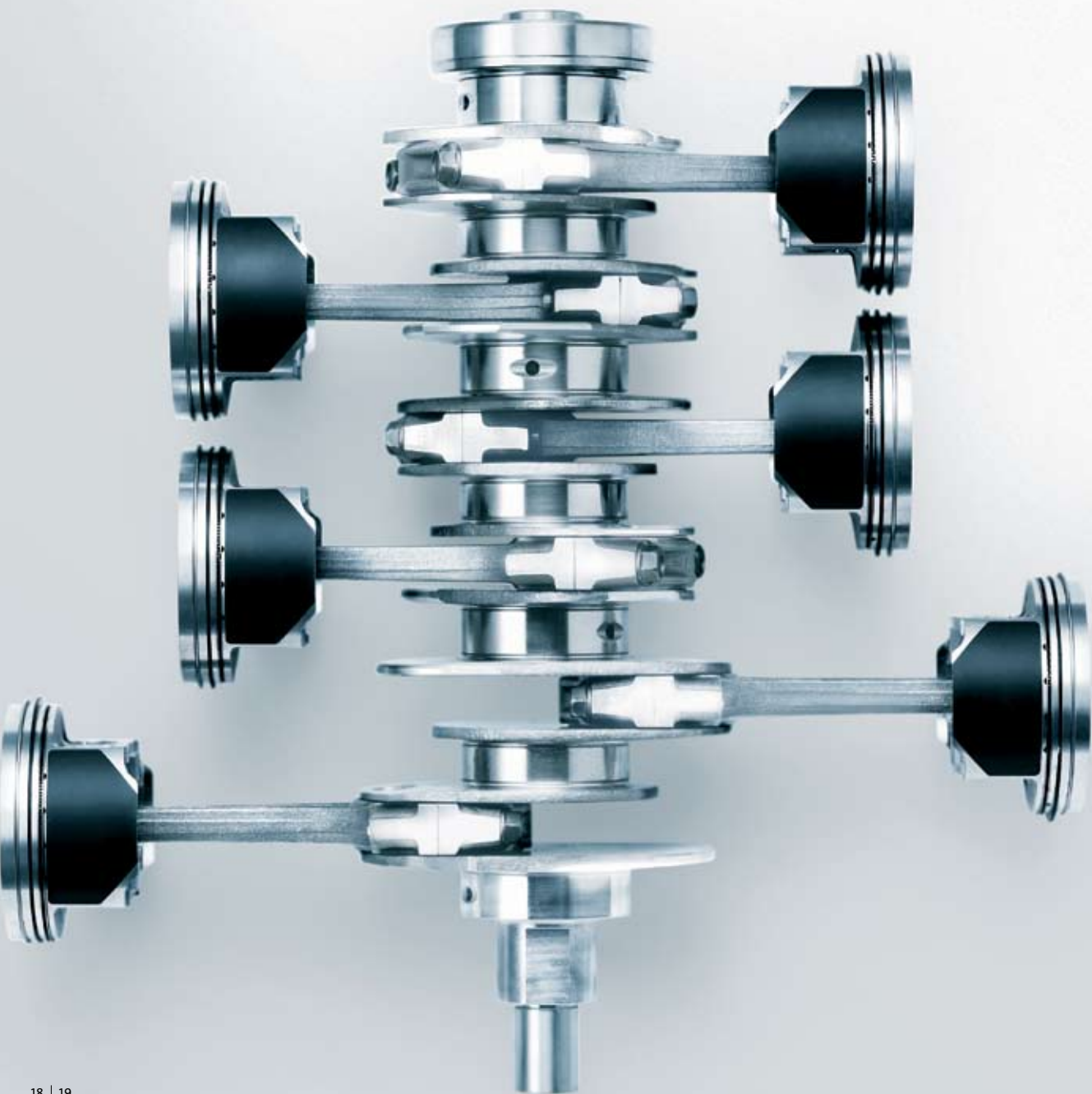

Enjoy the drive.

Let's face the facts: The average SUV isn't that fun to drive. It's a people-mover, a conveyance, an appliance at best. Luckily, the Subaru Tribeca is not the average SUV. Witness the state-of-the-art 5-speed automatic transmission. Or the 3.6L SUBARU BOXER engine that now produces more power (11 more hp; 32 more lb-ft of torque), fewer emissions and greater fuel economy – all on regular gas. All things considered, the Tribeca breaks new ground in the fun-to-drive sweepstakes.

3.6-litre DOHC horizontally-opposed 6-cylinder boxer
Output: 256 hp* @ 6,000 rpm; 247 lb-ft of torque* @ 4,400 rpm
Features: Active Valve Control System (dual), Active Valve Lift System
Characteristics: Powerful, efficient, responsive

*Peak horsepower and torque values are determined using the new SAE J1349 (Rev. 8/04) standard.

Next-generation engine technologies

Active Valve Control System (dual): This system employs variable valve timing technology to adjust the speed and timing of the intake and exhaust valves, thereby creating a much cleaner-burning engine. By having both intake and exhaust valves open momentarily, more air is drawn into the cylinder, thus creating something called "better filling efficiency". This, in turn, leads to increased torque at low and medium engine speeds, increased horsepower at high engine speeds, and improved fuel economy and reduced emissions throughout the rev range.

Active Valve Lift System: This system is also designed based on clean-thinking principals. It features two-piece valve lifters that work separately at low rpm or together at high rpm providing better low-end torque, top-end performance and engine efficiency, while allowing these vehicles to meet strict emissions standards.

5-speed Automatic Transmission

The Subaru Tribeca features an enhanced version of the 5-speed Electronic Direct Control Automatic Transmission with SPORTSHIFT™ (5EAT SS). Improvements to this technology have resulted in more linear acceleration, improved shift response, reduced shifting when going up and down hills, and improved fuel efficiency. The SPORTSHIFT™ feature allows for manual shifting with a simple flick of the gear selector; shifts are smooth and precise, allowing the driver to make the most of the engine's significant power.

This transmission also incorporates Variable Torque Distribution (VTD) and Vehicle Dynamics Control to further enhance driveability. VTD promotes spirited driving by maintaining a 45/55 front/rear torque split ratio in normal driving conditions and switching to a 50/50 front/rear torque split for maximum traction and stability when conditions demand and/or when Vehicle Dynamics Control engages. The Vehicle Dynamics Control system employs a network of sensors that work in conjunction with the 5EAT SS to further enhance responsiveness, handling and vehicle stability.

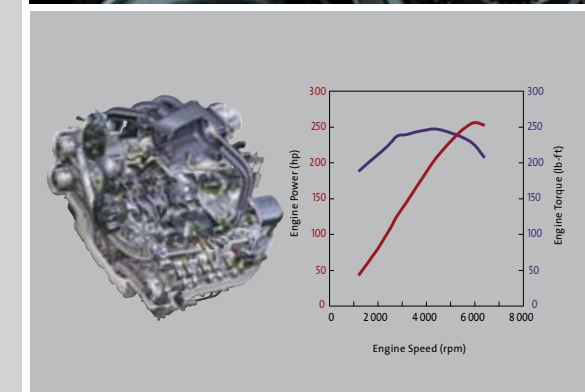

SUBARU BOXER 3.6L DOHC engine



5-speed Electronic Direct Control Automatic Transmission with SPORTSHIFT™



Poised handling, heightened confidence.

It's no mean feat to develop a full-size SUV that drives like a sports sedan. Of course, that task is made much simpler when you begin with rally-proven technology like the SUBARU BOXER engine and the Subaru symmetrical full-time AWD system. The Subaru Tribeca benefits from an uncompromising approach that places equal value on driving comfort and driving dynamics.

Rally-proven suspension

What effect do rough roads, rain, ice, sleet or snow have when confronted with a long-travel, 4-wheel independent suspension system honed on the grueling WRC circuit? Answer: Not much at all. The Subaru Tribeca boasts responsive handling and a smooth ride, combined with the rugged capability of a true SUV. The advanced rear double-wishbone suspension eliminates vibration, offers superb control and delivers a luxurious driving experience. The Tribeca's low centre of gravity and higher than average ground clearance of 213 mm also help maintain stability, traction and control when the going gets rough.

Lightweight components, heavyweight impact

To maximize the power-to-weight ratio and efficiency of the SUBARU BOXER engine, the Subaru Tribeca features a lightweight hood and numerous aluminum components. These weight-saving elements help create a stronger, more responsive and more fuel-efficient vehicle with an exceptionally low centre of gravity. These characteristics allow for the optimization of the suspension geometry which, in turn, creates exceptional dynamic handling capabilities.



Rally-proven suspension



Front strut suspension

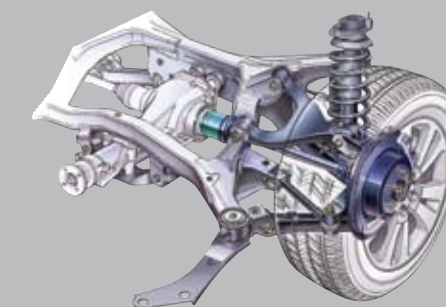

Rear double-wishbone suspension



Safe and sound engineering.

Built into each and every Subaru vehicle is the steadfast belief that occupant safety is of paramount importance. Active safety systems give the driver all the tools needed to avoid an accident. For example, better visibility enables the driver to see potential problems before they happen, while Subaru symmetrical full-time AWD and Vehicle Dynamics Control offer superior handling to help avoid these problems. Passive safety systems give all passengers the very best in protection in the event that an accident is unavoidable. The Subaru ring-shaped reinforcement frame, active front-seat head restraints and multiple airbags have all helped earn the Subaru Tribeca a 5-star* and 'Top Safety Pick'[†] crash test rating.

*Results for 2008 Subaru Tribeca model year. U.S. Government star crash test ratings are part of the National Highway Traffic Safety Administration's (NHTSA's) New Car Assessment Program (www.safercar.gov). A five-star crash test rating is the highest government rating for a) Driver and right front seating positions in frontal crash tests and b) Front and rear seating positions in side-impact crash tests.
[†]Results for 2007 Subaru Tribeca model year. Ratings of "Good" are the highest rating awarded for 40-mph frontal offset, 31-mph side-impact and 20-mph rear-impact crash tests conducted by the Insurance Institute for Highway Safety (IIHS). A "Good" rating obtained in all three crash tests and the availability of Electronic Stability Control (ESC) achieves a "Top Safety Pick".

Anti-lock Braking System (ABS)

The Subaru Tribeca features an anti-lock braking system with 4 sensors and 4 channels modulating brake pressure to each wheel instantaneously. The sheer stopping force generated by front brakes with dual-piston calipers and Brake Assist. The added brake cooling created by ventilated front and rear discs. And the increased efficacy of Electronic Brake-force Distribution (EBD) to ensure optimum brake performance regardless of passenger and cargo load. All adding up to a superior braking system that leaves nothing to chance. Full stop.

Vehicle Dynamics Control

Even when driving a vehicle with Subaru symmetrical full-time AWD, the laws of physics still apply and the level of available grip can be exceeded. In these rare times, it's comforting to know that Vehicle Dynamics Control[†] is standard on the Subaru Tribeca and is standing guard. This system employs a network of sensors to detect when a loss of control is imminent, then makes precise adjustments – altering AWD torque split, applying brake pressure to individual wheels and revising engine power output – to restore vehicle stability.

[†]Subaru's Vehicle Dynamics Control system may also be referred to as Electronic Stability Control.

Advanced ring-shaped reinforcement frame

The goal: A 360-degree barrier of protection. The response: One uniform, interconnected energy-absorbing safety cell comprised of the roof, door pillars, window pillars and floor. This cell envelops the entire passenger cabin, thereby helping to dissipate impact energy from all directions. The advanced ring-shaped reinforcement frame, energy-absorbing crumple zones and side-impact door beams combine to give the Subaru Tribeca award-winning collision safety for all occupants.

Seatbelts, airbags and head restraints

Dual front airbags with dual-stage inflation and built-in occupant sensors. Dual front side-impact airbags. Dual side curtain airbags with rollover sensors. Front seatbelts with pretensioners and load limiters. The ISO-FIX/LATCH child seat anchor system and three-point seatbelts for the rear seats. And active front-seat head restraints that automatically reduce the distance between the passenger and the head restraint in the event of a rear-end collision. All standard, all designed to offer superior occupant protection.

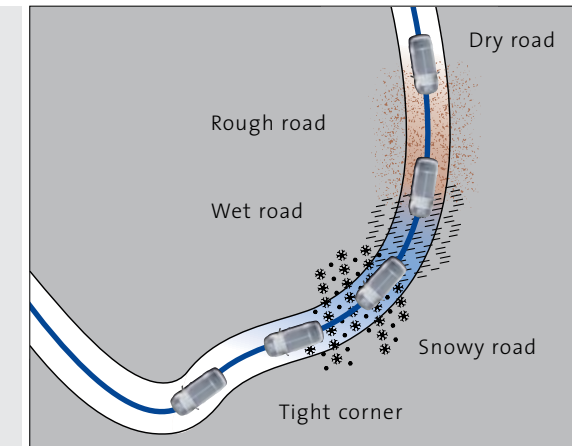

Subaru symmetrical full-time AWD delivers sure-footed roadholding in almost any condition



Six airbags

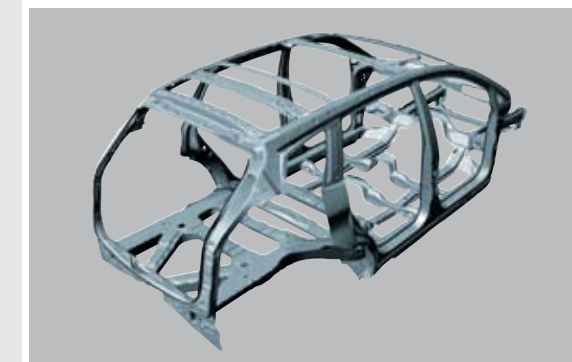

Advanced ring-shaped reinforcement frame

Tribeca

Horizontally-opposed, 6-cylinder, 3.6L SUBARU BOXER engine with Active Valve Lift System and Active Valve Control System (dual)

256 horsepower* and 247 lb-ft of torque*

5-speed Electronic Direct Control Automatic Transmission with SPORTSHIFT™ (5EAT SS)

Subaru symmetrical full-time All-Wheel Drive

Vehicle Dynamics Control system and Traction Control System (TCS)

Anti-lock Braking System (ABS), Brake Assist and Electronic Brake-force Distribution (EBD)

Engine immobilizer and anti-theft security system

Driver and front passenger front and side-impact airbags; side curtain airbags with rollover sensor (first and second row)

18" aluminum alloy wheels

Power tilting and sliding glass moonroof

Xenon High Intensity Discharge (HID) headlights (low beam)

Multi-reflector halogen fog lights

Power adjustable, foldable and heated body colour door mirrors with integrated LED turn signals

AM/FM/CD/MP3 audio system with 4 speakers, 2 tweeters, auxiliary audio input and compatible with XM® Satellite Radio and SIRIUS® Satellite Radio†

Air conditioning with automatic dual-zone climate control and air filtration

Raised-profile roof rails

HomeLink®

Heated, power adjustable front seats with lumbar support

40/20/40-split, flat-foldng and reclining second-row seating

Premium cloth upholstery



Fuel economy: 5EAT SS (L/100km): City 13.2/Hwy 9.4



Limited Package

Available upgrade package includes:

AM/FM/6CD/MP3 premium audio system with 4 speakers, 4 tweeters, subwoofer, auxiliary audio input and compatible with XM® Satellite Radio and SIRIUS® Satellite Radio†

Two-position memory function on driver's seat

Leather upholstery and interior trim

Premier Package

Available upgrade package includes:

AM/FM/6CD/MP3 premium audio system with 4 speakers, 4 tweeters, subwoofer, auxiliary audio input and compatible with SIRIUS® Satellite Radio†

XM® Satellite Radio (factory installed/subscription required)

GPS DVD-based navigation system and monitor system with touch-screen display

Rear-view camera in monitor system

Third-row seating with driver and passenger side access

DVD entertainment system with 9" screen, audio/video auxiliary input, remote control and 2 wireless headphones

50/50-split, flat-folding third-row seats

Two-position memory function on driver's seat

Rear-seat cooling system with separate controls

Leather upholstery and interior trim

Tribeca No-Charge Scheduled Maintenance Plan

As with all models in the Subaru lineup, the 2008 Subaru Tribeca has earned a well-deserved reputation for durability and reliability. To highlight these qualities even further, every new model comes with the Tribeca No-Charge Scheduled Maintenance Plan. With this plan, regularly scheduled maintenance items such as oil changes are free of charge for the first 36 months, up to 60,000 kilometres*. Further proof that the Subaru Tribeca is more than just your average SUV.



**For a full list of items covered under the plan refer to the No-Charge Scheduled Maintenance Plan chart at www.subarutribeca.ca/maintenance. This plan complements the Subaru 36-month/60,000-km New Vehicle Limited Warranty and the Subaru C.A.R.E. emergency roadside assistance program.*

	Tribeca	Limited Package	Premier Package
Deep Bronze Metallic	GC	BL	BL
Diamond Grey Metallic	GC	GL	GL
Harvest Gold Metallic	GC	BL	BL
Newport Blue Pearl	GC	GL	GL
Obsidian Black Pearl	GC	BL	BL
Quartz Silver Metallic	GC	GL	GL
Satin White Pearl	GC	BL	BL

GC Slate Grey Cloth GL Slate Grey Leather BL Desert Beige Leather

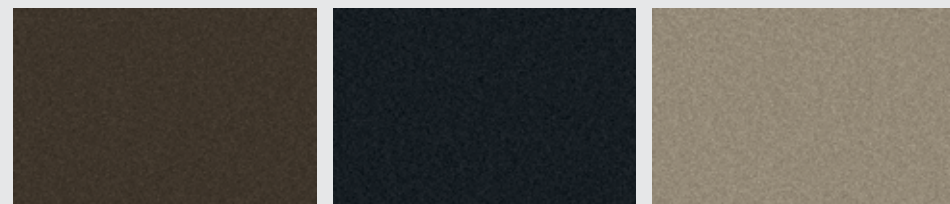

Deep Bronze Metallic Diamond Grey Metallic Harvest Gold Metallic

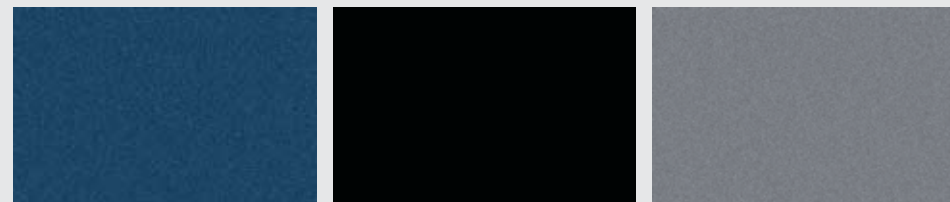

Newport Blue Pearl Obsidian Black Pearl Quartz Silver Metallic

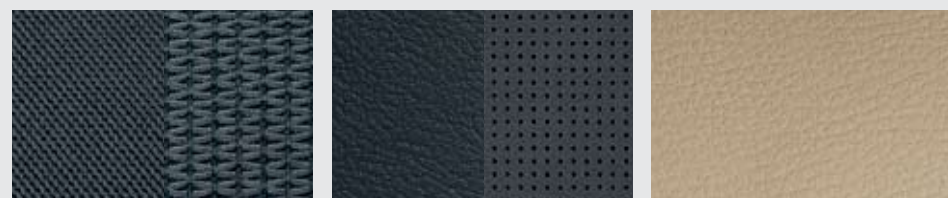

Slate Grey Cloth Slate Grey Leather Desert Beige Leather

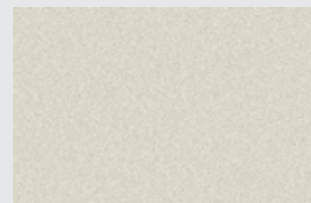

Satin White Pearl

Accessories fit for an extraordinary SUV.

Make no mistake: even the base Subaru Tribeca is loaded with luxury amenities. But for those seeking a little something extra, a few more creature comforts or a little bit of personalization, consult the following list of accessories and build the Tribeca of your dreams.

- Battery warmer
- Bike carrier (roof mounted)
- Bike carrier (trailer hitch mounted)
- Cargo area nets (rear, side, seatback)
- Cargo area tray
- Roof cargo box (several styles and sizes)
- Retractable cargo cover (tonneau)
- **Crossbar set**
- Compartment divider/dog guard
- **Hood deflector**
- Rearview mirror - auto-dim with compass
- Remote starter
- Reverse sensing system
- Satellite radio
- Security system upgrade - shock sensor
- Ski/snowboard carrier
- **Splash guards**
- Subwoofer/amplifier
- **Trailer hitch assembly**
- Wheel lock set

Visit www.subaru.ca or your local Dealer for more accessory options.

Accessory listed in bold shown on the Subaru Tribeca.

The Subaru Tribeca is pre-wired for XM® and SIRIUS® Satellite Radio, subscription services delivering 100% commercial-free music and radio programming. XM® Satellite Radio is standard with the Premier Package (factory installed/subscription required.)



Trailer hitch assembly Cargo tray and retractable cargo cover Reverse sensing system

Subaru Warranties

Every Subaru vehicle is designed and built to offer our customers the highest possible level of quality and reliability. We are proud of our vehicles and proud to stand behind them with a comprehensive warranty. For 2008 model year vehicles, the warranty on all Subaru vehicles consists of:

New Vehicle Limited Warranty (36 month/60,000 km) - Covers basic and major components for 36 months or 60,000 km.

Major Component Limited Warranty (60 month/100,000 km) - Extends coverage of major components (more than just powertrain) up to 60 months or 100,000 km.

Surface Corrosion Limited Warranty (36 month/60,000 km) - Covers surface corrosion to visible painted body panels for 36 months or 60,000 km.

Anti-Perforation Limited Warranty (60 month/unlimited km) - Covers perforation due to corrosion to body sheet metal panels for 60 months, regardless of kilometres.

Emission Control System Limited Warranty - Covers the majority of emissions components for 36 months or 60,000 km and the major parts of the emission control system for 96 months or 130,000 km.

Parts and Accessories Limited Warranty - Covers Subaru parts and accessories installed by the dealer prior to retail delivery of the vehicle for 36 months or 60,000 km, and Subaru parts and accessories installed by the dealer after the retail delivery of the vehicle for 12 months or 20,000 km from the date of the installation.

The above information is an overview of warranty coverage and is not a warranty statement. If you wish to see more details regarding Subaru warranties, please refer to your Subaru warranty booklet, contact your local Dealer or visit our Web site at subaru.ca.

Subaru Protection Plan

As a Subaru owner, you have expectations for a pleasurable, trouble-free ownership experience – now and into the future. Once your 36 month/60,000 km New Vehicle Limited Warranty period ends,* our Subaru Protection Plan can prolong your hassle-free ownership experience with 3 levels of extended service contract coverage tailored to your needs: *Powertrain Protection; Major Protection; or Complete Protection* (best level of coverage to complement the 60 month/100,000 km Major Component Limited Warranty). This extended service contract offers comprehensive mechanical and electrical coverage and a number of additional features and benefits. Be sure to ask your Dealer for details or visit subaru.ca.

**If you already own a Subaru vehicle and it is still within the 36 month, 60,000 km New Vehicle Limited Warranty period, you are still eligible.*

Subaru C.A.R.E. (Customer Assistance for Roadside Emergencies)

The SUBARU C.A.R.E. program – which is backed by the Canadian Automobile Association (CAA) – is offered free of charge for the first three years from date of purchase on every new Subaru vehicle or as part of a Subaru Protection Plan. As a SUBARU C.A.R.E. member, you can count on fast, courteous emergency roadside assistance 24 hours a day, 365 days a year. You will receive a membership card and have access to a dedicated toll-free telephone number (in English or French), allowing you to take advantage of over 20,000 roadside assistance contractors and 1,000 CAA and American Automobile Association (AAA) offices throughout Canada and the United States. Ask your Dealer for details or visit subaru.ca.

Subaru Canada, Inc. is proud to be the first vehicle manufacturer to have a direct relationship with CAA, giving our customers the benefit of CAA's unparalleled level of experience and service.





subaru.ca

The Supplemental Restraint System (SRS airbags) affords the driver and passenger additional protection in some collisions. This system provides supplemental protection only, and seatbelts must be worn in order to avoid injuries to out-of-position occupants upon airbag deployment. The combination of SRS and seatbelts provides the best protection in a serious accident. All illustrations, specifications, features and photographs contained in this brochure are based on product information available at the time of its printing, and may not be completely accurate following its publication. Colours shown may vary due to reproduction variations in the printing process, and some vehicle parts cannot be shown in certain photographs. Subaru Canada, Inc. reserves the right to discontinue or make changes at any time, without notice or incurring obligations, to colours, materials, equipment, accessories, features, specifications and models, or to change their prices. Some models shown may be from international markets and are not available in Canada, or they may be shown with equipment or accessories which are optional (at extra cost) or only available in certain combinations, or they may be subject to product delays or not be available in Canada. Please visit our Web site for the latest information and specifications. For complete details on product updates, warranties or the Subaru CARE program, please contact your Subaru Dealer. Tribeca, Subaru, SUBARU BOXER, Subaru CARE and Subaru CARE Customer Assistance for Roadside Emergencies are registered trademarks. Apple and iPod are registered trademarks of Apple Computer, Inc. HomeLink is a registered trademark of Johnson Controls, Inc. "SIRIUS" and the SIRIUS dog logo are trademarks of SIRIUS Satellite Radio Inc. SPORTSHIFT is a registered trademark of Prodrive Ltd. XM is a registered trademark of XM Satellite Radio Inc. Printed in Canada. © 2007 Subaru Canada, Inc. 2008 model year.



Environmental Management System (EMS) ISO 14001:2004 certified by SGS
Brochure is printed on 100% chlorine-free bleached pulp (TCF) and uses vegetable-based inks to be fully recyclable with no harmful residue.
www.subaru-earth.com