



The new Ford **Fusion** | 2006



Colorado Red
solid body colour



Deep Navy
solid body colour



Diamond White
solid body colour



Moon dust Silver*
metallic body colour



Panther Black*
metallic body colour



Spanish Olive*
metallic body colour



Sea Grey*
metallic body colour



Tango Red*
metallic body colour



Tonic*
metallic body colour



Jeans*
metallic body colour



Amethyst*
metallic body colour



Sublime*
metallic body colour

MY 2006 GBR en



Collect Nectar points at participating Ford Dealers now. So keep a look out for the latest Ford offers at www.ford.co.uk/nectar or call the Ford Information Service on 0845 7111 888.*

Dealer

Published by Ford Motor Company Limited, Brentwood, Essex, England. Registered in England No. 235446. BJN 301150. FoE H04E. FA 1430/5. PN 579510/1005/130m/GBR en October 2005. © Ford Motor Company Limited.

www.ford.co.uk

The Government fuel figures do not express or imply any guarantee of the fuel consumption of any particular car. The cars themselves have not been tested and there are inevitably differences between individual cars of the same model. In addition, a car may incorporate particular modifications. Furthermore, the driver's style and road and traffic conditions, as well as the extent to which the car has been driven and the standard of maintenance, will affect its fuel consumption. Insurance groups are only as recommended by the Association of British Insurers. You should always consult your insurance adviser for confirmation. Illustrations, descriptions and specifications. This catalogue was correct at the time of going to print. However, Ford policy is one of continuous product development. The right is reserved to change specifications, colours and prices of the models and items illustrated and described in this publication at any time. For the latest details always consult your Ford Dealer. Optional equipment. Throughout this publication, wherever a feature is described as being an 'Option' or 'Optional Fitment/Pack', etc., you should assume that it will be at extra cost to the base vehicle, unless specifically stated to the contrary. All models and colour combinations are subject to availability. *Ford Information Service. Calls are charged at national rate and may be recorded for training purposes.

Bluetooth®
The Bluetooth® word mark and logos are owned by the Bluetooth SIG, Inc. and any use of such marks by Ford Motor Company is under licence. Other trademarks and trade names are those of their respective owners.

Designed for living. Engineered to last

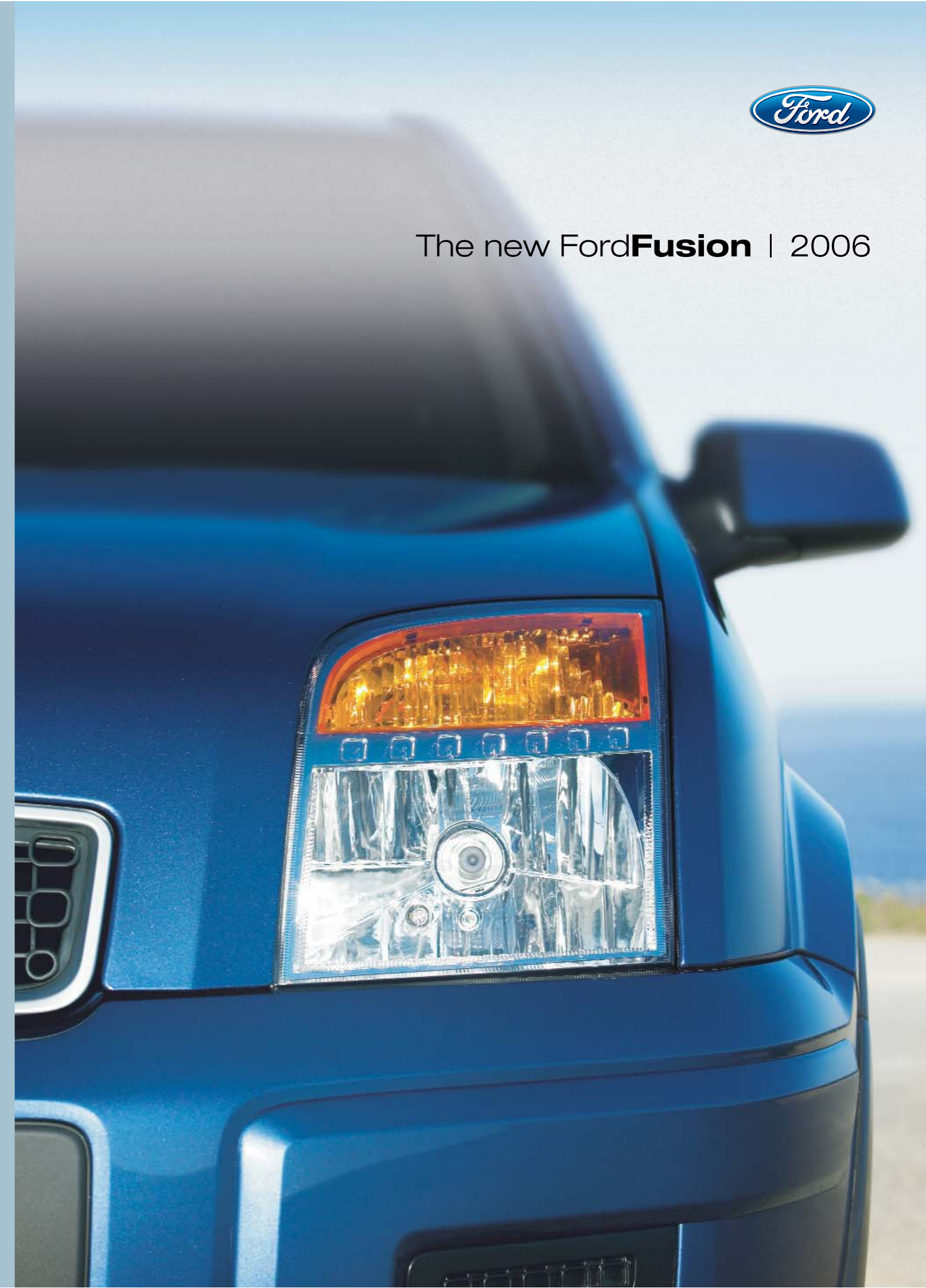



Dark Tanzanite Indigo Tanzanite Violet Tanzanite Onyx Dream Amethyst Dream Crystal Dream Opal Haze Amethyst Haze



Platinum Wave Amethyst Wave Crystal Wave Opal Haze Amethyst Haze

Trim and body colour availability

Model	Style/Style Climate			Zetec/Zetec Climate					Fusion +				
Seat trim/bolster trim	Ecrin - Ebony/ Mondus - Ebony	Ecrin - Iris/ Mondus - Iris	Ecrin - Iris/ Mondus - Iris	Ecole - Ebony/ Mondus - Ebony	Ecole - Iris/ Mondus - Ebony	Ecole - Cream/ Mondus - Iris	Lauren Embossed Leather** - Ebony/ Prima - Ebony	Lauren Embossed Leather** - Ebony/ Prima - Ebony	Floe - Ebony/ Trudie - Ebony	Floe - Iris/ Trudie - Ebony	Floe - Cream/ Trudie - Cream	Lauren Embossed Leather** - Ebony/ Prima - Ebony	Lauren Embossed Leather** - Ebony/ Prima - Ebony
Door trim and colour	Modem in Ebony	Modem in Iris	Modem in Iris	Modem in Ebony	Modem in Iris	Modem in Iris	Hannover Vinyl in Ebony	Hannover Vinyl in Ebony	Trudie in Ebony	Trudie in Ebony	Trudie in Cream	Hannover Vinyl in Ebony	Hannover Vinyl in Ebony
Environment colour: Upper/Lower	Dark Pewter/ Ebony	Iris/Ebony	Iris/Cream	Dark Pewter/ Ebony	Iris/Ebony	Iris/Cream	Dark Pewter/Ebony	Iris/Ebony	Dark Pewter/ Ebony	Iris/Ebony	Iris/Cream	Dark Pewter/Ebony	Iris/Ebony
Interior Combination Name	Dark Tanzanite	Indigo Tanzanite	Violet Tanzanite	Onyx Dream	Amethyst Dream	Crystal Dream	Opal Haze	Amethyst Haze	Platinum Wave	Amethyst Wave	Crystal Wave	Opal Haze	Amethyst Haze
Solid body colours													
Diamond White	●	●	●	●	●	●	●	●					
Colorado Red	●	●	●	●	●	●	●	●	●	●	●	●	●
Deep Navy	●	●	●	●	●	●	●	●	●	●	●	●	●
Metallic body colours													
Moondust Silver	○	○	○	○	○	○	○	○	○	○	○	○	○
Panther Black	○	○	○	○	○	○	○	○	○	○	○	○	○
Jeans	○	○	○	○	○	○	○	○	○	○	○	○	○
Tonic	○	○	○	○	○	○	○	○	○	○	○	○	○
Sublime	○	○	○	○	○	○	○	○	○	○	○	○	○
Spanish Olive	○	○	○	○	○	○	○	○	○	○	○	○	○
Sea Grey	○	○	○	○	○	○	○	○	○	○	○	○	○
Tango Red	○	○	○	○	○	○	○	○	○	○	○	○	○
Amethyst	○	○	○	○	○	○	○	○	○	○	○	○	○

● = Standard, ○ = Optional, at extra cost. ** Leather trim is an option at extra cost.

Contents	Ford Fusion	Series	Personalise	Services	Specification
	04 Exterior styling	42 Model series	51 Interior and exterior styling	57 Finance and services	58 Specification
	10 Safety	44 Style/Style Climate	52 Entertainment and navigation		
	16 Flexibility	46 Zetec/Zetec Climate	53 Safety		
	20 Interior quality	48 Fusion +	55 Wheels		
	24 Performance and handling		56 FordBoutique		
	30 Intelligent technology				
	36 Innovative thinking				

Ford Fusion. Another dimension

Experience life from a different perspective with the Ford Fusion. Tall, tough and protective, yet compact and agile, Ford Fusion adds an exciting new dimension to the small-car driving experience.

To really study the Ford Fusion, you need to look at it from every angle – the bold, expressive exterior; the generous, flexible space; the stylish, high-quality interior and the intelligent use of technology.

There's more than one reason why this 'big' little car stands out in the crowd. So take a closer look at the Ford Fusion and draw your own conclusions.

Note Some of the vehicle images in this brochure are of a pre-production model and are computer generated, therefore, the design/features on the final version may differ in various respects. In addition, some of the features shown on the vehicle may be optional or not available in this market.

Model Fusion +.
Options (at extra cost) Amethyst metallic paint.



One simple raw egg. Small and fragile. But stand it upright and you'll find it's stronger than you think. Designed to drop safely from hen to ground, this little egg is tough when it's tall.

The Ford Fusion is another fine example of intelligent design in a small package. Standing tall and proud with its tough exterior, it boasts a higher driving position and all-round visibility as well as all the large-car features you won't want to sacrifice. With the Ford Fusion, you can have it all and keep it small.

Opposite
Model Fusion Style Climate
Options (at extra cost) Sublime metallic paint.
Next page
Model Fusion Style Climate
Options (at extra cost) Tonic metallic paint. Power-fold door mirrors
Accessories (at extra cost) 16" 7-spoke alloy wheels.





Bodyside mouldings and side skirts

Ford Fusion's exterior boasts strengthened bodyside mouldings across all models and more substantial side skirts on Fusion Zetec, Fusion Zetec Climate and Fusion +.

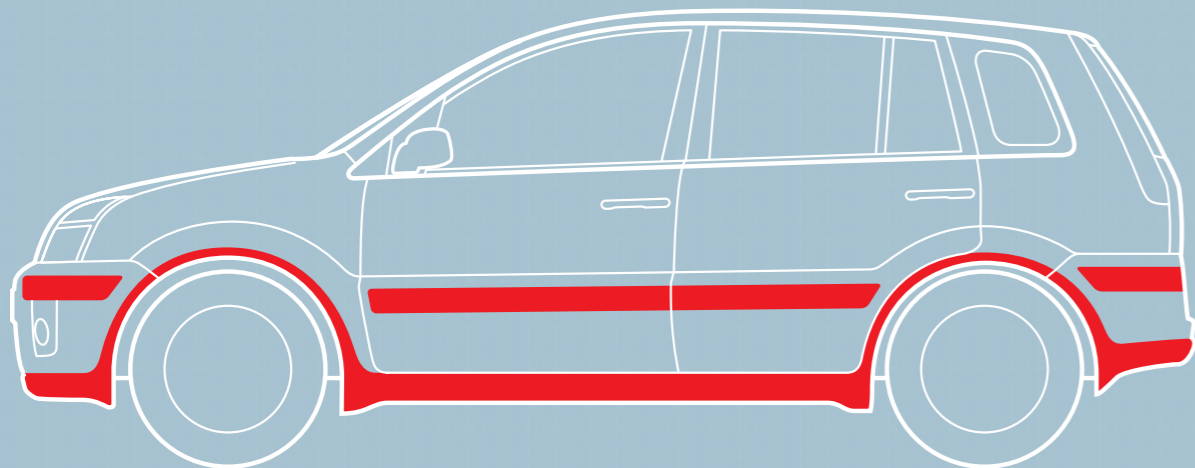

Protection against the inevitable

Designed with those little knocks in mind, Ford Fusion's new bodyside mouldings offer added protection when parking's tight.

Tall and tough, yet incredibly grounded

With its tall stance and tough exterior, Ford Fusion gives you greater road presence, whilst delivering superb roadholding and stability. Combine this with its elevated seating position and panoramic visibility and you'll see why the Ford Fusion takes everything in its stride.



Enhanced visibility

A light and airy interior with large windows delivers greater all-round visibility, while the rear head restraints retract while not in use. Vehicle featured is fitted with Reflex Pack (at extra cost).

Command driving position

Ford Fusion's tall body and elevated seats give you a superior view of the road ahead for a more confident driving experience.



The small car that's big on safety

This is where the Ford Fusion gets really tough. While its ultra-stiff body structure provides the foundation for its excellent directional stability and control, its tough steel safety cage, with side impact door beams, absorbs energy in the event of a collision.

You'll also be reassured by Ford Fusion's advanced safety system that offers a combination of up to six airbags* (at extra cost).



As well as featuring driver and passenger front airbags* as standard, Ford Fusion is one of the first compact cars to offer side curtain airbags (at extra cost).

*Note: A child seat should never be placed in the front passenger seat when the Ford vehicle is equipped with an operational front passenger's airbag. The safest place for children is properly restrained on the rear seat.

Anti-submarining seats

Every one of Ford Fusion's seats has an anti-submarining ramp under the front edges of the cushions to help prevent passengers sliding under the seat belts should there be a frontal impact.

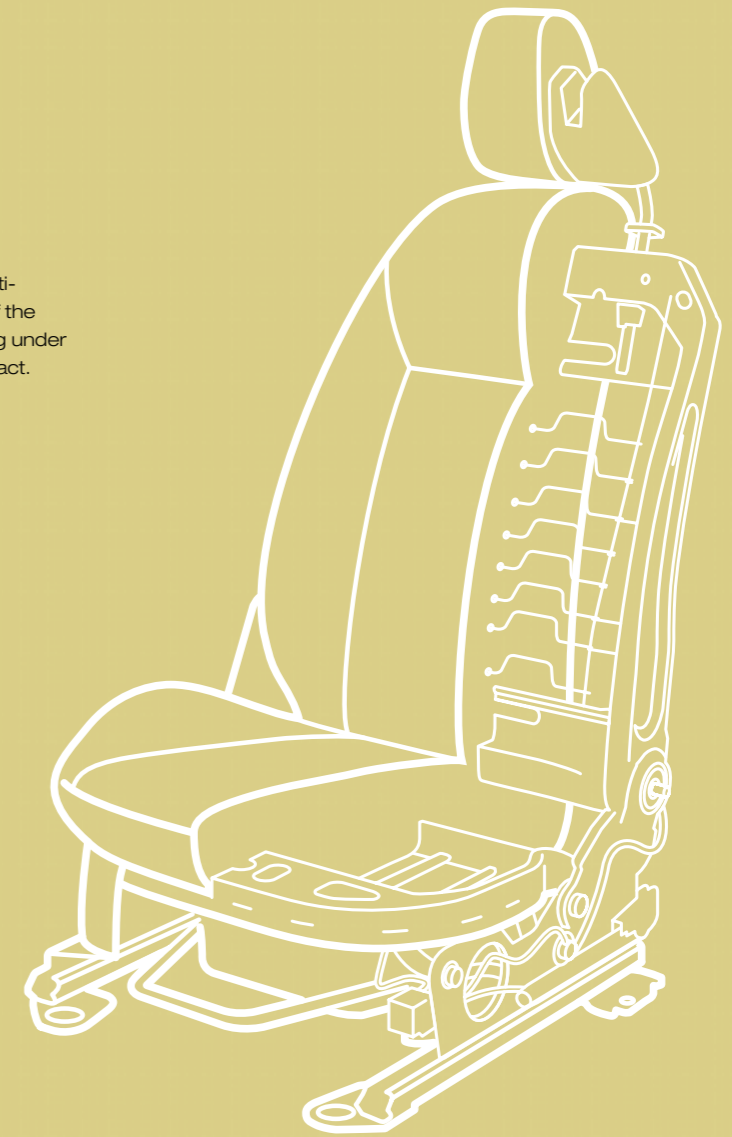

Anti-lock brakes

All Ford Fusion models are fitted with Electronic anti-lock brakes (ABS) and electronic brake-force distribution (EBD) as standard. This helps you to maintain control in an emergency.



Remote locking

All Ford Fusion models are fitted with remote central/double locking with illuminated entry as standard. This is for added safety and convenience.

Opposite
Model Fusion +
Options (at extra cost) Jeans
metallic paint.
Next page
Model Fusion Style Climate
with Indigo Tanzanite interior
Options (at extra cost) Power-fold
door mirrors, Reflex pack.



When it comes to storage, the cube is by far the most intelligent solution. Its volume is easy to calculate, and its solid shape encourages the greatest use of space. Sometimes it's the simplest ideas that work the best.

The Ford Fusion is as clever as it is compact. Its shape has been designed with maximum storage capacity in mind, while its low loading lip provides easy access to its spacious boot. Then there's the flexible seating system that offers an array of different configurations, according to your passengers and luggage. So everything fits as it should.





It's not rocket science, just intelligent thinking

Not only is the Ford Fusion deceptively spacious and flexible, it also offers some intelligent features to make your life easier, like its low loading lip and fold-flat front passenger seat that doubles as a handy table.



60:40 split rear seats

If you're carrying something that's a little on the bulky side, the rear seats are fully split 60:40 and can be folded down quickly and easily, without the need to remove the head restraints.



Flexible interior

The flexible seating includes a fold-flat front passenger seat on selected models, providing space for items up to 2.3 metres long.

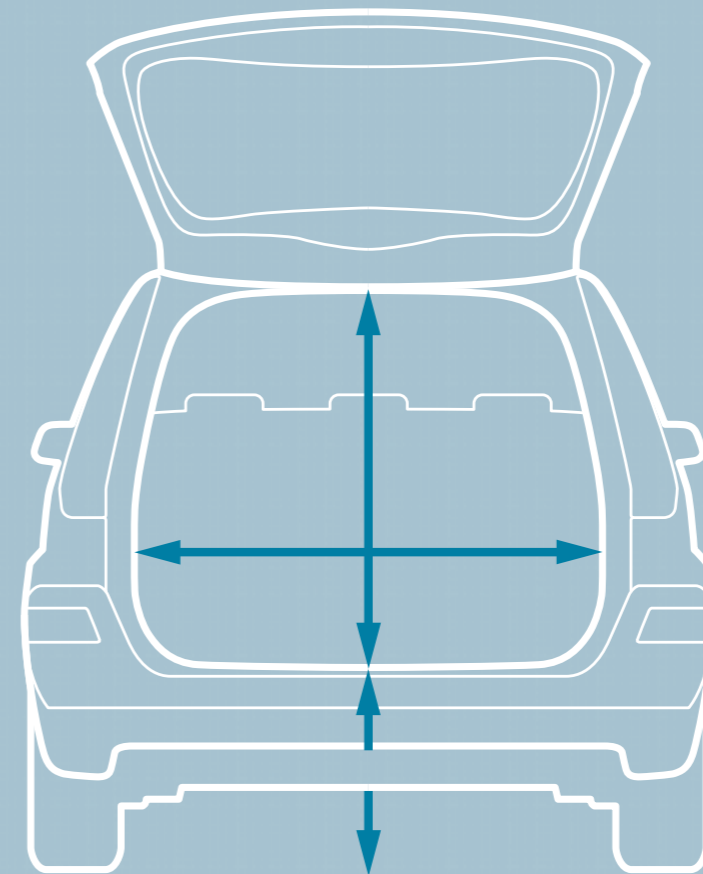

Simply spacious

When both rear seats are folded flat, the Ford Fusion delivers an impressive 1,175 litres of luggage space. That's the equivalent of 587 2-litre bottles of drink. And, thanks to its low loading lip, you'll be able to load and unload effortlessly.



One seat or five?

Whether it's just you and your luggage, or the whole family and theirs, Ford Fusion is more than accommodating.

A place for everything

With the Ford Fusion, it's not just the passengers that are taken care of – luggage also gets preferential treatment. Not only does the flexible seating allow for all kinds of passenger and luggage combinations, there's also an array of innovative stowage solutions dotted around the cabin. So that all those little things you bring with you have their place.

Sunglasses holder

When things get a little bright, your sunglasses will be within easy reach thanks to this sturdy driver's-side holder. Standard on Fusion Zetec, Zetec Climate and Fusion +).



Individual glovebox compartments

Fusion's glovebox has a place for everything, with its pen, ticket and handbook compartments as well as eight handy coin slots.



Storage compartment

Sometimes you need to keep a few things to hand while you're on the move. This conveniently situated flip-top storage compartment does the job nicely.



Lidded compartment

Neatly concealed on the driver's side of the instrument panel is a small compartment, perfect for coins, sweets or other small items.

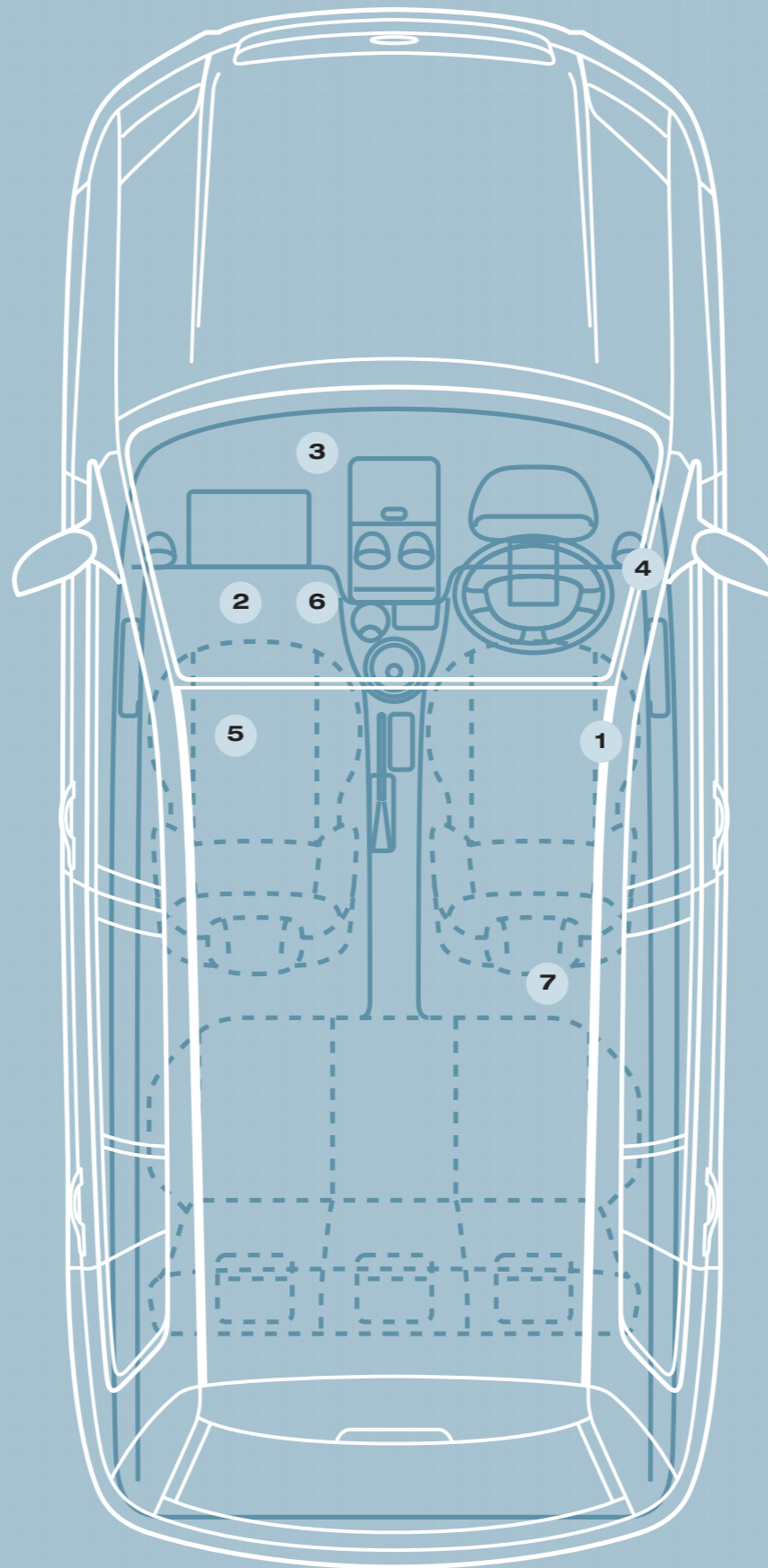
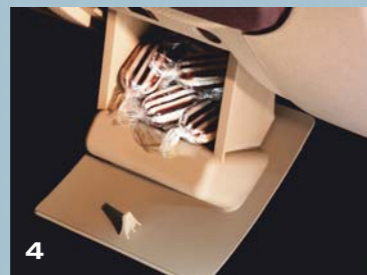

Under-seat storage

Hidden beneath the front passenger seat is a handy storage tray, so you can tidy items away and keep them safely out of sight.



Centre console stowage

This useful storage tray keeps important items to hand. It also incorporates a cup holder, designed to snugly hold a 330 ml can of drink.



Map pocket

A roomy map pocket gives easy access to your road atlas or street map. (On driver's seat).

Opposite
Model Fusion + with Opal Haze
interior
Next page
Model Fusion + with Platinum
Wave interior
Options (at extra cost) Electronic
Automatic Temperature Control
(EATC).



How can you tell if a diamond is the real thing? The answer is simple – breathe on it, and if it clouds over, it's probably counterfeit. It just goes to show, sometimes you have to look a little closer to appreciate true quality.

Ford Fusion offers you the finer things in life. Its stylish interior merges contemporary design with quality craftsmanship, creating a relaxed and comfortable large-car environment. From the refined fascia to the sophisticated range of trims, every detail works in harmony to make this small car a cut above the rest.





Opposite
Model Fusion Style
Options (at extra cost) Tango Red metallic paint.
Next page
Model Fusion + (both)
Options (at extra cost) Sea Grey and Moondust Silver metallic paint.



You'd need a steady hand to tackle this challenge. Just one wrong move and the buzzer will sound the moment metal touches metal. To complete it successfully takes excellent visual tracking skills, co-ordination and expert manoeuvrability.

Whether it's tight bends, tiny parking spaces or winding roads, Ford Fusion takes everything in its stride. With its superb handling and easy cornering, you'll find it incredibly easy to manoeuvre. With a range of responsive and economical engines, Ford Fusion delivers a rewarding drive, no matter how challenging your journey.





Complete control at every corner

The open road, the back lanes. Twists, turns and tiny gaps. Ford Fusion can tackle them all. It's power steering and tight turning circle give you superb handling and manoeuvrability. Not only can you take tight corners with ease, you'll also be able to snap up those small parking spaces that other cars have to pass by.

Whatever engine and transmission you choose, you'll enjoy an incredibly responsive drive. For extra peace of mind, there's Electronic Stability Programme (ESP) with Emergency Brake Assist (EBA) available on selected models (at extra cost), that helps you maintain control in critical driving situations.

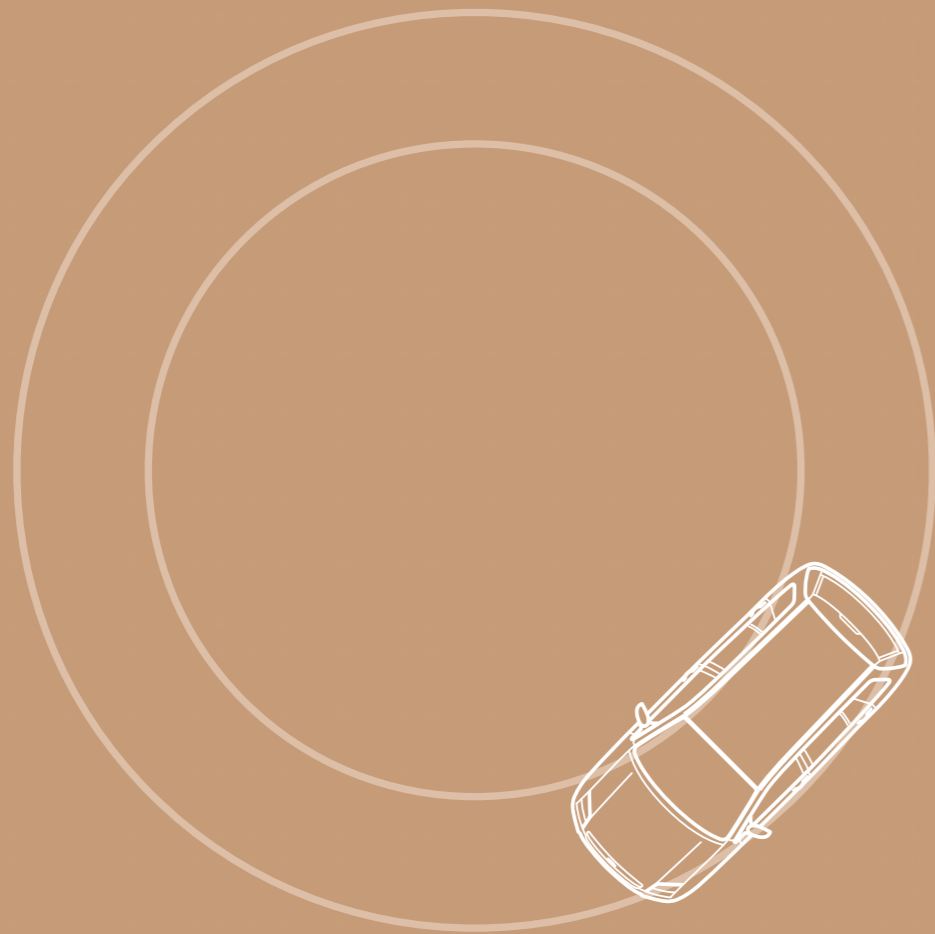

Tight turning circle

With a 9.3 metre kerb-to-kerb turning circle, Ford Fusion is perfectly designed to get you out of any tight spots.



Power-fold door mirrors

If you need to squeeze through a small gap or into a tight parking space, Ford Fusion is ready to make things easier with its innovative power-fold door mirrors. At the touch of a button, you can avoid those little scrapes and knocks that can easily happen when space is limited. Available on selected models (at extra cost).

Responsive engines

You can choose between two Duratec 16V petrol engines – an 80 PS 1.4-litre or a 100 PS 1.6-litre. There's also the punchy Duratorq 1.4-litre TDCi turbo diesel with the latest common-rail injection technology or the lightweight, high-output 1.6-litre 16V Duratorq TDCi turbo diesel, for the ultimate in performance.



Choose your transmission

A Durashift 5-speed manual transmission is standard across the range. Then there's the Durashift EST advanced manual transmission* with sequential manual mode which removes the need for a clutch pedal, plus a smooth automated mode. Finally, there's the Durashift automatic transmission** for the ultimate in effortless driving.

*Available as an option on 1.4i petrol engines only.
**Available on 1.6i engines only.

P
R
N
D
2
1

Opposite
Model Fusion +
Options (at extra cost) Amethyst
metallic paint.
Next page
Model Fusion Style Climate
Options (at extra cost) Tonic
metallic paint.



The Venus flytrap is a sensitive little thing. When an insect touches the trigger hairs inside its leaves, they fire off waves of electrical activity almost identical to nerve impulses. The leaves then snap shut and the insect is trapped.

Like this clever little plant, the Ford Fusion is highly sensitive to its environment. With the availability of rain-sensing wipers, automatic headlights with Home Safe feature and air conditioning with Electronic Automatic Temperature Control (EATC), the car can sense exactly what you need when you need it. It's this kind of innovative thinking that sets Ford Fusion apart.





In touch with its environment, inside and out

Whether it's starting to rain or the sun's beginning to set, Ford Fusion is ready to respond with its highly sensitive technology, designed to let you concentrate on your journey.

It's not just a clear vision of the road ahead that's important – Ford Fusion also has the technology to help you park safely and efficiently.

Option = Can only be ordered with your new vehicle (at extra cost).
Accessory = Available from your Ford Dealer (at extra cost).



Auto headlights with Home Safe feature

Fusion's auto headlights switch on automatically when light levels begin to drop. They also come with a Home Safe feature that means your headlights will stay on for a few seconds to illuminate your path after you've parked. Standard on Fusion +. Available on all other models (at extra cost).



Rain-sensing wipers

When the raindrops begin to fall, Ford Fusion is ready to respond. Thanks to a discreet sensor on the windscreen, the wipers will automatically start working when the windscreen becomes wet. Standard on Fusion +. Available on all other models (at extra cost).



Electronic Automatic Temperature Control

Select a temperature that makes you feel comfortable and let the Ford Fusion keep things that way with its built-in temperature control system. Available on selected models (at extra cost).



Rear parking sensor

As well as its exceptional handling and manoeuvrability, Ford Fusion also comes with a rear parking sensor, should you need a little extra assistance getting into those tight parking spaces. Available on all models (Option and Accessory).

Opposite
Model Fusion + with Crystal Wave interior
Options (at extra cost) Electronic Automatic Temperature Control (EATC)
Next page
Model Fusion + with Platinum Wave interior
Options (at extra cost) Remote Control DVD System, Electronic Automatic Temperature Control (EATC)



As a tuning fork vibrates, it causes molecules in the air to move and bump into each other in a series of compressions and rarefactions that make up sound waves. The result is a clear, crisp sound that enables you to tune any instrument to the right pitch.

Ford Fusion's voice activation system* works simply by reacting to sound waves from your vocal cords. It allows you to control the climate*, audio system and Bluetooth® hands-free telephone system*. Ford Fusion also offers you a Portable music connection socket* for your MP3 player or personal CD player. It's all about intelligent, useful technology that works together to enhance your driving experience.

*Available as an option (at extra cost). Climate voice control only available where (EATC) is fitted.





Not just technology for technology's sake

Everything about the Ford Fusion has been designed to make your driving life easier and more enjoyable. That's why we believe in including technical features that you will actually find useful, both for long trips and day-to-day driving.

With intelligent communication systems like voice activation, satellite navigation and Bluetooth®, a high-quality entertainment system and thoughtful touches like heated door mirrors, Ford Fusion has chosen its favourite large-car features and made them available in a smaller package.



Bluetooth® Hands-free Technology and Voice Control System*

For conversations on the move, Ford Fusion's voice-controlled Bluetooth® hands-free technology lets you keep your hands on the wheel. Available on all Fusion models (at extra cost).

One-shot-down driver's window

Just a brief touch of a button is all it takes to fully open the driver's window. Standard on all Fusion models.



Bosch Blaupunkt TravelPilot EX satellite navigation system**

Another large-car feature, Ford Fusion's high-quality satellite navigation system guides you safely to your destination with a friendly voice and visual directions. Available on all Fusion models (at extra cost).

Bluetooth® The Bluetooth® word mark and logos are owned by the Bluetooth SIG, Inc. and any use of such marks by Ford Motor Company Limited and its associated companies is under licence. Other trademarks and trade names are those of their respective owners.
* Does not include mobile phone or cradle. ** Available in 2006.

DVD entertainment system

Ford Fusion's DVD entertainment system comes complete with CD and MP3 capability and is also compatible with most electronic game consoles. Available on Fusion + (at extra cost).

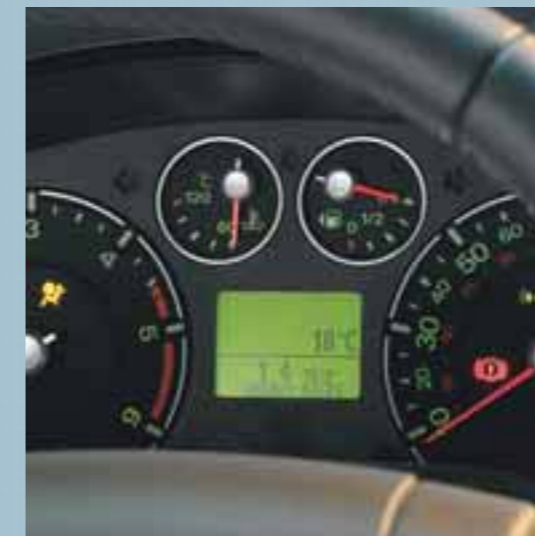

Multifunction trip computer

Whether it's fuel economy, miles to empty, average speed, trip distance or external temperature, Ford Fusion's trip computer keeps you informed. Standard on all models except Style and Style Climate.

Heated door mirrors

Ford Fusion's heated door mirrors clear frost or ice at the touch of a button for a clear view almost instantly. Standard on Style Climate and Zetec Climate.





Different models, different tastes

Ford Fusion is available in three distinct models, all with rugged and protective five-door styling.

Style/Style Climate With its energetic spirit, Fusion Style and Style Climate offers more features as standard such as air conditioning and electrically-operated front windows.

Zetec/Zetec Climate Bringing cosmopolitan luxury to the Fusion range, Fusion Zetec and Zetec Climate turns heads with its smart 15" alloy wheels, fog lights and satin grille surround.

Fusion + The range-topping Fusion + with its 16" alloy wheels, tinted rear windows, power-fold mirrors, rain-sensing wipers and automatic headlamps.

So, which Ford Fusion will you choose?

Model Fusion + Options (at extra cost) Amethyst metallic paint.
Model Fusion Zetec Options (at extra cost) Tonic metallic paint.
Model Fusion Style Options (at extra cost) Tango Red and Sublime metallic paint.



Style/Style Climate

Fusion Style offers sophisticated touches such as electrically-operated front windows, remote control, central locking and remote tailgate release. Inside, you'll find even more flexibility thanks to its fold-flat front passenger seat back, presenting you with a handy work surface or table.

Model Fusion Style Climate with Indigo Tanzanite interior

Options (at extra cost) Sublime metallic paint, Electronic Automatic Temperature Control (EATC), Power-fold door mirrors

***Note:** A child seat should never be placed in the front passenger seat when the Ford vehicle is equipped with an operational front passenger's airbag. The safest place for children is properly restrained on the rear seat.



Dark Tanzanite



Indigo Tanzanite



Violet Tanzanite

Key features

- 15" steel wheels with full wheelcovers
- Electrically-operated front windows with one-shot-down driver's window
- Stereo radio/CD
- Remote central/double locking with illuminated entry and tailgate release
- Courtesy light with theatre-style dimming
- Anti-lock brakes (ABS) with electronic brake-force distribution (EBD)
- Driver's and passenger airbags*
- Immobiliser - PATS (passive Anti-Theft System)
- 60:40 split/folding rear seats with folding back and flip-up cushion
- Fold-flat front passenger seat back with integrated work surface
- Driver's seat with manual height adjustment

Style Climate - additional to Style

- Electrically-operated heated door mirrors
- 'Quickclear' heated front windscreen
- CFC-free air conditioning with air recirculation



Zetec/Zetec Climate

Distinguished and luxurious, Fusion Zetec brings a touch of class to every journey with extra features such as soft velour seat fabric and leather-covered gear knob with satin aluminium insert. Outside, you'll find gleaming alloy wheels, bodystyling kit, satin aluminium grille surround and front fog lights that make sure Fusion Zetec attracts its share of second looks.



Onyx Dream



Crystal Dream



Amethyst Dream



Amethyst Haze



Opal Haze

Additional to Style

- 15" alloy wheels
- Full perimeter bodystyling kit
- Front fog lights
- Body colour bodyside mouldings, bumper inserts and tailgate lift handle
- Satin aluminium finish radiator grille surround
- Trip computer
- Leather-covered gear knob with satin aluminium insert
- Front map reading lights
- Clear side indicators
- Driver's side sunglasses stowage

Zetec Climate - additional to Zetec

- Electrically-operated heated door mirrors
- 'Quickclear' heated front windscreen
- CFC-free air conditioning with air recirculation

Model Fusion Zetec Climate with Opal Haze interior

Options (at extra cost) Tonic metallic paint, Electronic Automatic Temperature Control (EATC)



Fusion +

Fusion + really is the leader of the pack with its 16" alloy wheels, body styling kit and rear privacy glass. Inside, you can add all of Ford Fusion's favourite large-car technology such as voice activation, satellite navigation and a MultiMedia entertainment system with DVD, MP3 and computer console compatibility (at extra cost).



Platinum Wave



Crystal Wave



Amethyst Wave



Amethyst Haze



Opal Haze

Additional to Zetec

- 16" 7-spoke alloy wheels with 195/55 tyres
- Dark-tinted privacy glass on rear windows
- Power heated door mirrors with power-fold (body-coloured)
- Electrically-operated heated door mirrors
- 'Quickclear' heated front windscreen
- CFC-free air conditioning with air recirculation
- Perimeter alarm
- Rain sensing wipers and automatic headlights
- Leather-trimmed steering wheel
- Rear power point
- Scuff plates and carpet mats
- Additional front stowage pockets and boot stowage hooks
- Upgraded loadspace carpet with protective runners

Add a personal touch to your new Fusion

Your Ford Fusion will become uniquely yours with a range of options and accessories to choose from. Personalise your style, sophistication and comfort and enhance your driving experience.

Option = Can only be ordered with your new vehicle (at extra cost).
Accessory = Available from your Ford Dealer (at extra cost).

Base load carrier The lockable base load carrier is compatible with a wide range of attachments such as roof boxes, bike carriers and ski carriers. (Accessory)

Thule ProRide Bike carrier Easy to fit and use, this adjustable, lockable bike carrier can accommodate frames from 20-80 mm in diameter. (Accessory)

ClimAir side window air deflectors These wind deflectors reduce turbulence and so allow you to enjoy your drive with the front windows down, even when it's raining. (Accessory)

FordBoutique bike Mountain bike with 18-speed Shimano shift, 26" frame. Ford logo can easily be removed. (Accessory)

Tow bar For extra transport and stowage capability, the tow bar can tow up to 900 kg depending on engine. Available as fixed or detachable versions. (Option and Accessory)

Contoured mudflaps Available as sets for front and rear, these practical, hard-wearing mudflaps protect the bodywork from stone chips, helping to keep your Ford Fusion clean by reducing road spray. (Accessory)

Interior styling A sporty gear shift knob (Option and Accessory) and handbrake cover (Option) with aluminium and leather design are available. The centre-stack bezel in silver gives Fusion's interior a further touch of class. (Accessory)

Eibach sports suspension kit The Eibach sports suspension enhances driving performance and handling as well as giving a more sporty appearance. Lowers the car by 30 mm. (Accessory)

Becker 'Indianapolis' navigation system This premium system allows you to listen your favourite CDs/MP3s while providing excellent navigation. (Option and Accessory). Can be combined with an additional 6-CD changer. (Accessory)

CD box for DIN sized radio bezel This CD box provides storage for four CDs. (Accessory, only in combination with DIN-sized radio bezel).

Opposite 16" 8-spoke alloy wheels. (Accessory)



Entertainment and navigation

Ford Fusion offers high-quality navigation and entertainment systems, for your convenience and enjoyment. Various audio systems to suit your needs are also available.

Option = Can only be ordered with your new vehicle (at extra cost).
Accessory = Available from your Ford Dealer (at extra cost).



Becker 'Indianapolis' navigation system

This premium system allows you to listen to your favourite CDs/MP3s while providing excellent navigation. (Option and Accessory) Can be upgraded with an additional 6-CD changer. (Accessory)

CD box for radio bezel

This CD box provides storage for four CDs. (Accessory, only in combination with DIN-sized radio bezel)

DIN-sized radio bezel

Allows fitment of your choice of DIN-sized audio systems. (Accessory)

Extra features for your safety and comfort



Britax Römer child seat

Provides optimum all-round protection and comfort. Various seats are available for all ages. Removable and washable cover. (Accessory)



Rear parking sensor

An audible warning helps you safely judge the distance between the rear of your car and an obstacle for easier parking and manoeuvring. (Option and Accessory)



Safety and Emergency equipment

Be prepared for the unexpected with this range of safety and emergency equipment (warning triangle, high visibility safety vest, fire extinguisher, first aid kit, tow rope and jump leads). (Accessory)



Premium velour carpet floor mats

With unique Fusion logo. Driver's mat is fixed to prevent slippage. Standard on Fusion +. (Accessory)



Carpet floor mats

Smart and hard-wearing, with an anthracite colour. Driver's mat is fixed to prevent slippage. (Accessory)



Contour rubber mats

Tough, easy to clean and equipped with the Ford logo. Driver's mat is fixed to prevent slippage. (Accessory)

Style in motion

Each striking wheel has been designed to complement Ford Fusion's tall, tough looks. Choose from a selection of stylish wheel options. All give your Fusion a distinctive look that's guaranteed to get you noticed and make heads turn.

Accessory = Available from your Ford Dealer (at extra cost).

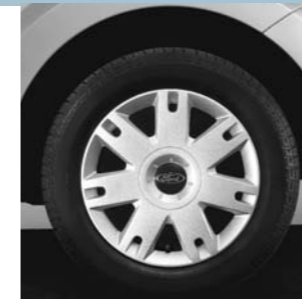

15" 7-spoke wheelcover
(Standard on Style and Style Climate)



15" 6x2-spoke alloy wheel
(Standard on Zetec and Zetec Climate)

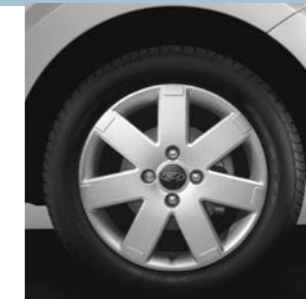

16" 7-spoke alloy wheel
(Standard on Fusion +)



15" 9-spoke alloy wheel
(Accessory)

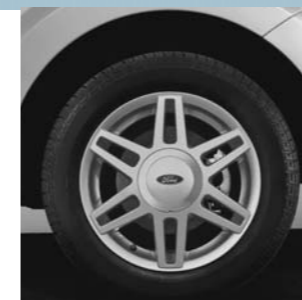

15" 6x2-spoke silver alloy wheel
(Accessory)



15" 6x2-spoke machined alloy wheel
(Accessory)

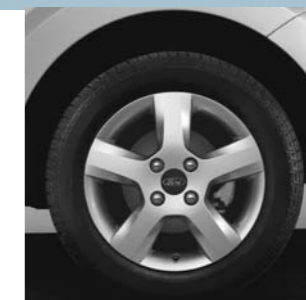

15" 5-spoke alloy wheel
(Accessory)



16" 7-spoke alloy wheel
(Accessory)

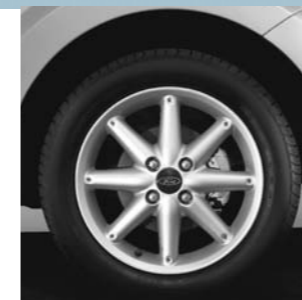

16" 8-spoke alloy wheel
(Accessory)

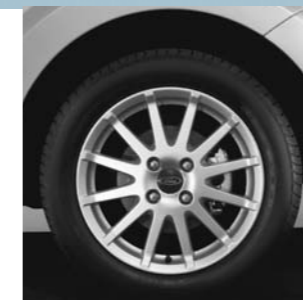

16" 12-spoke alloy wheel
(Accessory)

Opposite Bold 16" 12-spoke alloy wheel.
(Accessory)

The icing on the cake

You'll love your Ford Fusion. So why not show how proud you are of your tall, tough companion by treating yourself to an original Ford**Boutique** item? Choose from the unique Ford**Boutique** golf bag, golf balls and tees, or adorn yourself with the Ford**Boutique** watch. For more Ford**Boutique** items, please see the main catalogue.



Ford**Boutique** golf bag, Ford**Boutique** Festina watch, Ford**Boutique** golf balls and golf tees

Transport solutions, over and above

Among Ford Fusion's innovative luggage solutions is this elegant, Thule Deluxe fully-lockable ski carrier. Suitable for up to six pairs of skis or four snowboards. (Accessory)



Finance and services

Across the UK, a dedicated network of Ford Dealers is equipped and trained to meet the needs of today's drivers. Because of our coveted reputation for quality and reliability, from the moment your new vehicle leaves the showroom, you are assured of lasting, attentive service in many ways. Ford not only cares through Dealers, we also offer a variety of finance and leasing schemes to suit the needs of both the private and business customer. With our wide choice of plans and services no one is more committed to delivering complete motoring confidence and total peace of mind than Ford.

Ford Credit

As part of Ford Motor Company, Ford Credit offers convenient and competitive financial services to Ford customers. Choose, try, finance and insure your Ford – without having to leave the showroom.

Ford Options Ford Options is the flexible way to finance your Ford. If you are looking to renew your vehicle more often, this is the ideal plan. At the end of the agreement, choose which option suits you best – own the vehicle, return it or choose a new one.

Ford Acquire Ford Acquire is a simple method of vehicle finance for private customers. Convenient to arrange, and with flexible terms to suit your needs, owning your Ford has never been so easy.

Ford Business Partner As a specialist division of Ford Credit dedicated to partnering businesses, Ford Business Partner will work with you to achieve a complete Contract Hire transport solution.

Ford Insure Ford Insure offers a wide range of great value products for you and your Ford, including Comprehensive Motor Insurance, Payment Protection Plan* and Guaranteed Asset Protection**. When you purchase a Ford from a Ford Dealer, you will receive 7 days' Driveaway cover*** free when you call Ford Insure for a no-obligation annual quotation.

What's the next step? Your local Ford Dealer will be pleased to help if you have any further queries and advise you of current special promotions. Your Dealer can also supply a personalised quotation for the finance plan and vehicle of your choice.

Services

Company Car Drivers Talkback - the company car drivers' club offers members extended test drives, tax and buying advice as well as special offers and invitations to special driver events. To join, log on to www.talkbackclub.com or call 0845 605 55 66 - it's free and you don't even have to drive a Ford.

Ford Mobility MAGIC (Mobility and General Information Centre) is a Ford-dedicated care centre created to provide free and comprehensive information on all motoring and mobility issues to anyone requiring such assistance. MAGIC has many special offers for HRDLA recipients, or Motability scheme users, call free on 0800 240 241.

Ford Protect Every new Ford car sold is protected by 12 months' unlimited mileage manufacturer's warranty, plus the option of extending this warranty to a 3-year/60,000 miles Ford Protect Classic Plan at no extra cost. Upgrades are also available, giving you the option of extended Ford Assistance and scheduled servicing.

Ford Rapid Fit The national fast-fit network backed by Ford, offering you the convenience of a 'no-appointment-necessary, while-you-wait' service covering tyres, exhausts, brakes, batteries and much more. There are over 260 sites nationwide.

Ford Accident Repair Centres If your Ford is involved in an accident, your Ford Dealer is best placed to return it to its pre-accident condition. Dealerships displaying the Ford Accident Repair Centre sign all meet the rigorous customer service and repair quality standards laid down by Ford, and offer a three-year repair guarantee.

Ford Customer Relationship Centre In the unlikely event that your Ford Dealer can't help you or you need to speak to Ford directly, the Ford Customer Relationship Centre is just a phone call away. Call local rate 0845 841 1111.

Ford Rental - local service nationwide Providing quality car and van rental from Ford's latest model range. For further information contact your local Ford Dealer.

Finance subject to status and conditions, to over 18s only. Guarantees/ Indemnities may be required. Written quotations available on request: Freepost Ford Credit. Correct at the time of going to print. Contact your Dealer for terms and conditions. Business Partner Contract Hire is provided by Lex Vehicle Leasing. Ford Insure is underwritten by Norwich Union Insurance Limited, registered in England no. 99122. Authorised and regulated by the Financial Services Authority. Registered office at 8 Surrey Street, Norwich NR1 3NG. A member of the Aviva group. For our joint protection, calls may be recorded or monitored. *Please refer to Payment Protection policy booklet for full details of the benefits and exclusions. **Ford Insure Guaranteed Asset Protection is underwritten by Mapfre Assistencia Agency Ireland. Authorised and regulated by the Financial Services Authority. Registered in Ireland no. 903874. Registered address 22/26 Prospect Hill, Galway, Ireland. ***Excesses apply. Please refer to Summary of Cover for details. Maximum five vehicles. Not available in conjunction with any other promotion.

Exterior dimensions

	5-door
Exterior (mm)	
Overall length	4013
Overall width without mirrors	1724
Overall width with mirrors	1950/1963*
Overall height (laden)	1512
Overall height (unladen)	1543
Liftover height (to boot lip)	538
Wheelbase	2486
Front track	1477-1487
Rear track	1435-1445

* Fusion Zetec & Fusion +

Interior dimensions

	5-door
Front (mm)	
Effective headroom (without sunroof)	1015
Effective headroom (with sunroof)	977
Maximum effective leg room	1045
Shoulder room	1358
Rear (mm)	
Effective headroom	981
Maximum effective leg room	953
Shoulder room	1326
Stowable luggage (cu m)[†]	
5-seat mode	0.337
2-seat mode (laden to belt line)	0.734
2-seat mode (laden to roof)	1.175

[†] Measured using the VDA method. Dimensions may vary dependent on the model and equipment fitted.

Engine data

	Engine technical features	Maximum power [°]	Maximum torque [°]
1.4 Duratec 1388 cc	4 cylinders in line; DOHC; 16 valves; alloy cylinder head and block; electronic multipoint fuel injection; electronic throttle	58 kW (80 PS) at 5700 min ⁻¹ (rpm)	124 Nm at 3500 min ⁻¹ (rpm)
1.6 Duratec 1596 cc	4 cylinders in line; DOHC; 16 valves; alloy cylinder head and block; electronic multipoint fuel injection; electronic throttle	74 kW (100 PS) at 6000 min ⁻¹ (rpm)	146 Nm at 4000 min ⁻¹ (rpm)
1.4 Duratorq TDCi Diesel 1399 cc	4 cylinders in line; SOHC; 8 valves; alloy cylinder head and block; direct injection with high-pressure, common-rail, multipoint fuel injection system; turbocharger; electronic throttle	50 kW (68 PS) at 4000 min ⁻¹ (rpm)	160 Nm at 2000 min ⁻¹ (rpm)
1.6 Duratorq TDCi Diesel 1560 cc	4 cylinders in line; DOHC; 16 valves; alloy cylinder head and block; direct injection with high-pressure, common-rail, multipoint fuel injection system; turbocharger with intercooler; electronic throttle	66 kW (90 PS) at 4000 min ⁻¹ (rpm)	204 Nm at 1750 min ⁻¹ (rpm)

[°] Tested in accordance with ISO 1585.

Transmission data

	Transmission technical features
Durashift manual 5-speed	Floor-mounted gear lever; hydraulic driver-operated clutch
Durashift EST advanced manual 5-speed	Electronic Shift Transmission (EST); Floor-mounted gearlever; hydraulic computer automated clutch with no clutch pedal; sequential manual mode with tip-up/tip-down gear changing; automated mode with kickdown function and hill climb and descent sensing
Durashift automatic 4-speed	Floor-mounted gearlever; fully automatic operation with torque converter; optional manual selection of 1st and 2nd gears; 4th gear lock-out switch; kickdown function; hill climb and descent sensing

Fuel, performance and emissions

	CO ₂ emissions (g/km) ^{°°}	Fuel consumption L/100 km (mpg)**			Performance [°]		
		Urban	Extra Urban	Combined	Max. speed kph (mph)	0-62 mph (secs)	31-62 mph (secs)
5-door Ford Fusion							
1.4 Duratec (80 PS) Euro IV	154	8.5 (33.2)	5.3 (53.3)	6.5 (43.5)	163 (101)	14.0	17.3
1.4 Duratec (80 PS) Durashift EST advanced manual transmission. Euro IV	148	8.0 (35.3)	5.2 (54.3)	6.2 (45.6)	164 (102)	15.3	14.3
1.6 Duratec (100 PS) Euro IV	157	8.9 (31.7)	5.3 (53.3)	6.6 (42.8)	178 (111)	11.1	14.3
1.6 Duratec (100 PS) Durashift automatic transmission Euro IV	181	10.3 (27.4)	6.1 (46.3)	7.6 (37.2)	176 (109)	13.1	n/a
1.4 Duratorq TDCi (68 PS) Euro IV	119	5.6 (50.4)	3.9 (72.4)	4.5 (62.8)	158 (98)	16.3	15.7
1.6 Duratorq TDCi (90 PS) Euro IV	119	5.5 (51.4)	4.0 (70.6)	4.5 (62.8)	176 (109)	12.9	9.3

^{*} In 4th gear. [°]Ford test figures. ^{°°}All CO₂ emissions figures in g/km and fuel consumption figures in L/100 km are from officially approved tests in accordance with EEC Directive 1999/100/EC. The CO₂ emissions and fuel consumption test figures shown in the chart do not express or imply any guarantee of the emissions or fuel consumption of a car of the class in question. All the figures are based on tests conducted on vehicles with standard wheels and tyres; optional or accessory wheels and tyres may have an effect on the emissions and fuel consumption of a vehicle. **Note:** All vehicles are Durashift 5-speed manual unless otherwise stated.

Model availability, weights and loads

	Style	Style Climate	Zetec	Zetec Climate	Fusion +	Gross Vehicle Mass (kg)	Max. braked towing limit at GVM (kg)
5-door Ford Fusion							
1.4 Duratec (80 PS) Euro IV	1161	1161	1162	1162	1167	1605	900
1.4 Duratec (80 PS) Durashift EST advanced manual transmission Euro IV	1167	1167	1168	1168	1173	1605	500
1.6 Duratec (100 PS) Euro IV			1165	1165	1170	1605	900
1.6 Duratec (100 PS) with ESP Euro IV			1165	1165	1170	1600	900
1.6 Duratec (100 PS) Durashift automatic transmission Euro IV			1170	1170	1175	1630	900
1.4 Duratorq TDCi (68 PS) Euro IV	1162	1162	1162	1162	1167	1640	750
1.6 Duratorq TDCi (90 PS) Euro IV			1171	1171	1175	1675	750

^{*}Represents the lightest kerbweight assuming full fluid levels, 90% fuel levels and 75 kg allowance for the driver, subject to manufacturing tolerances and options, etc., fitted. **Key:** This table shows the availability of engine and gearbox combinations on Ford Fusion models and their resulting kerbweights. All vehicles are Durashift 5-speed manual unless otherwise stated. **Towing limits** quoted represent the maximum towing ability of the vehicle at its Gross Vehicle Mass to restart on a 12 per cent gradient at sea level. The performance and economy of all models will be reduced when used for towing. **Roof rack load** is a maximum of 25 kg for models without ESP (Electronic Stability Programme) and 50 kg for models with ESP.

Intelligent Protection System

At the heart of Ford Fusion's safety technology is its advanced Intelligent Protection System. The system uses sensors that can determine the nature of an incident in a fraction of a second, and cleverly activate the most appropriate airbag response.



Advanced seat belt system

All five seats are fitted with three-point inertia reel seat belts. The front seat belts feature pyrotechnic pre-tensioners that remove slack from the webbing in an impact, and load-limiting retractors that progressively release a small amount of webbing to help reduce the risk of chest injury.



Insurance groups

	Style	Style Climate	Zetec	Zetec Climate	Fusion +
5-door Ford Fusion					
1.4 Duratec (80 PS)	4E	4E	4E	4E	6E
1.4 Duratec (80 PS) Durashift EST advanced manual transmission	4E	4E	4E	4E	6E
1.6 Duratec (100 PS)			5E	5E	7E
1.6 Duratec (100 PS) Durashift automatic transmission			5E	5E	7E
1.4 Duratorq TDCi (68 PS)	4E	4E	4E	4E	6E
1.6 Duratorq TDCi (90 PS)			5E	5E	7E

Mechanical features

	Style	Style Climate	Zetec	Zetec Climate	Fusion +
Brakes					
Diagonally-split, with dual-line servo-assistance. Front discs, rear drums	●	●	●	●	●
Anti-lock brakes (ABS) with electronic brake-force distribution (EBD)	●	●	●	●	●
Fuel tank					
Usable capacity – Petrol – 45 litres, Diesel – 43 litres	●	●	●	●	●
Steering					
Rack-and-pinion	●	●	●	●	●
Power-assisted	●	●	●	●	●
Steering column – Tilt-adjustable	●	●	●	●	●
Suspension and body					
Front – Independent with MacPherson struts and subframe-mounted 'L' arm. Anti-roll bar	●	●	●	●	●
Rear – Twist-beam with coil springs	●	●	●	●	●
Electronic Stability Programme (ESP) (1.6 petrol only, not with Durashift EST advanced manual transmission or Durashift automatic transmission). Available only with Reflex pack, which must be charged separately			○	○	○
Towing eyes – Detachable front and welded rear	●	●	●	●	●
Transmission					
Durashift 5-speed manual transmission	●	●	●	●	●
Durashift EST 5-speed advanced manual transmission (1.4 petrol only)	○	○	○	○	○
Durashift 4-speed automatic transmission (1.6 petrol only)			○	○	○
Turning circle					
Kerb to kerb 9.3 m	●	●	●	●	●

● = Standard, ○ = Optional, at extra cost.

Safety and security features

	Style	Style Climate	Zetec	Zetec Climate	Fusion +
Safety					
Fuel cut-off – Inertia switch (petrol only)	●	●	●	●	●
Side impact door beams, front and rear. Steel safety cage with engine compartment cross beam. Energy-absorbing crumple zones, front and rear	●	●	●	●	●
Steering column – Additional bracing	●	●	●	●	●
Airbags – Driver's and front passenger's*	●	●	●	●	●
Airbags – Front side thorax airbags	□	□	□	□	□
Airbags – Side air-curtain airbags deployed from the headlining	□	□	□	□	□
Seat belts – Front, lap and diagonal inertia reel with grabbers, pre-tensioners and height-adjustable mounts	●	●	●	●	●
Seat belts – Rear, lap and diagonal inertia reel	●	●	●	●	●
Security					
Home-Safe Lights	●	●	●	●	●
Alarm – Perimeter	○	○	○	○	○
Fuel cap – Locking with body colour flap	●	●	●	●	●
Immobiliser – Passive Anti-Theft System (PATS)	●	●	●	●	●
Locks – Anti-burst, high security, shielded with strengthened mountings, childproof on rear doors	●	●	●	●	●
Locks – Remote central/double locking with illuminated entry and Greeting Lights	●	●	●	●	●
Vehicle Identification Number (VIN) – Visible	●	●	●	●	●
Wheel nuts – Locking			●	●	●

● = Standard, ○ = Optional, at extra cost, □ = Part of an option pack, at extra cost.

*Note: A child seat should never be placed in the front passenger seat when the Ford vehicle is equipped with an operational front passenger's airbag. The safest place for children is properly restrained on the rear seat.

Wheel availability

	Style	Style Climate	Zetec	Zetec Climate	Fusion +
Wheels					
6x15" steel (15" 'temporary' steel spare* with 125/80 R15 Low Rolling Resistance (LRR) tyre) with full wheelcovers and 195/60 R15 Low Rolling Resistance (LRR) tyres	●	●			
6x15" 6x2-spoke alloy wheels (15" 'temporary' steel spare* with 125/80 R15 Low Rolling Resistance (LRR) tyre) and 195/60 R15 Low Rolling Resistance (LRR) tyres			●	●	
6x16" 7-spoke alloy wheels (15" 'temporary' steel spare* with 125/80 R15 Low Rolling Resistance (LRR) tyre) and 195/55 R16 Low Rolling Resistance (LRR) tyres					●

● = Standard, ○ = Optional, at extra cost.

*Note: If the spare wheel rim or tyre size differs from the other wheels fitted: DO NOT drive in excess of 80 km/h. DO drive the least possible distance.

1.6 Duratorq TDCi Diesel

For the ultimate blend of power with economy, the highly acclaimed 1.6-litre Duratorq TDCi turbo diesel engine delivers effortless performance for safe and confident overtaking.

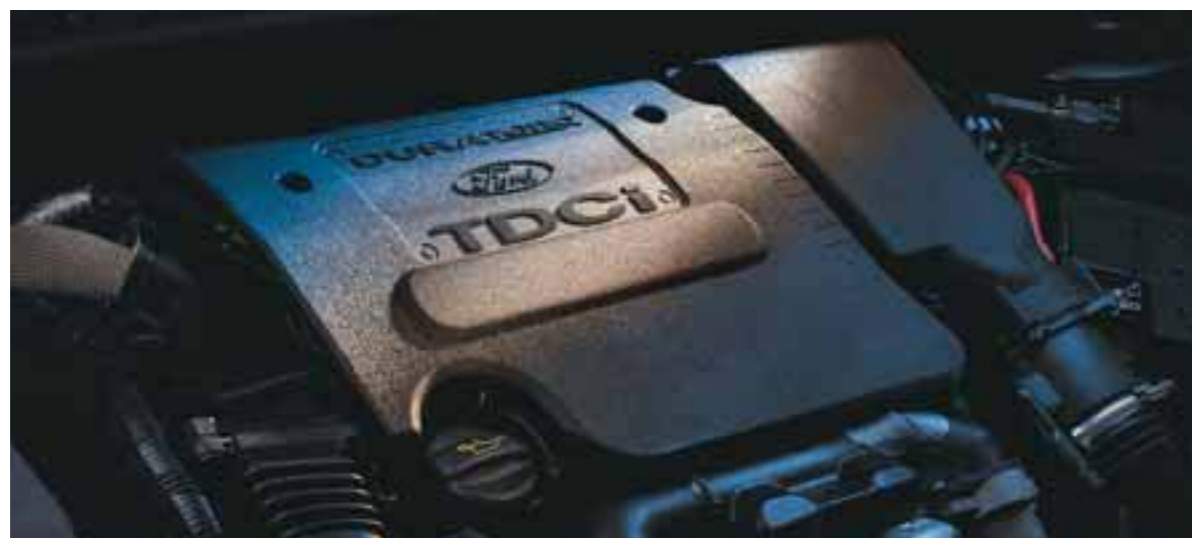

1.6 Duratec

The punchy 1.6 Duratec 16-valve, 100 PS petrol engine brings new levels of driving refinement to every journey. This powerful engine also boasts remarkable fuel economy and low CO₂ emissions.



1.4 Duratorq TDCi Diesel

The Ford Fusion's 1.4 Duratorq TDCi engine is a remarkable performer, combining lively performance with legendary diesel efficiency and low emissions.



Exterior features

	Style	Style Climate	Zetec	Zetec Climate	Fusion +
Exterior appearance and styling					
Bodyside mouldings – Black self colour	●	●			
Bodyside mouldings – Body colour			●	●	●
Bumpers – Body colour with black self colour inserts	●	●			
Bumpers – Body colour with body colour inserts			●	●	●
Door handles - Black self colour	●	●			
Door handles - Body colour			●	●	●
Paint – Metallic	○	○	○	○	○
Perimeter body kit – Grey self colour, including protective wheel arch lips, bumper spoilers and rocker panel extensions			●	●	●
Radiator grille – Black mesh upper and slatted lower front grille	●	●			
Radiator grille – Mid-grey mesh upper with satin aluminium surround and slatted lower front grille			●	●	●
Tailgate lift handle – Black self colour	●	●			
Tailgate lift handle – Body colour			●	●	●
Exterior functional					
Door mirrors – Manual internal control, black housings	●		●		
Door mirrors – Electrically-operated and heated, black housings		●		●	
Door mirror - Electrically-operated and heated with Power-Fold, body colour housings		○		○	●
Heated rear window	●	●	●	●	●
Heated windscreen – ‘Quickclear’		●		●	●
Tailgate release – Remote	●	●	●	●	●
Front windows – Tinted glass	●	●	●	●	●
Rear windows – Tinted glass	●	●	●	●	●
Rear windows – Dark-tinted privacy glass			○	○	●
Wheel arch liners – Front and rear	●	●	●	●	●
Wipers – Front, 2-speed, with programmable interval intermittent wipe and electric wash	●	●	●	●	●
Wipers – Front, delayed ‘anti-drip’ wipe after wash/wipe function	●	●	●	●	●
Wipers – Tailgate wiper with electric wash	●	●	●	●	●
Wipers – Tailgate, reverse gear activation (when front wipers are in use)	●	●	●	●	●
Wipers - Automatic rain-sensing, with automatic headlamps	○	○	○	○	●
Exterior lighting					
Halogen headlights, side lights, rear fog light, reversing light, high-mounted rear brake light	●	●	●	●	●
Fog lights – Front			●	●	●
Headlight levelling	●	●	●	●	●

● = Standard, ○ = Optional, at extra cost.

Audio and communication systems

	Style	Style Climate	Zetec	Zetec Climate	Fusion +
Audio					
Stereo radio/CD – Model 6000CD RDS EON, ‘Keycode’ anti-theft coding, 4 speakers	●	●	●	●	
Stereo radio/CD – Model 6006CDC RDS EON, with 6-disc in-dash CD autochanger, remote controls, ‘Keycode’ anti-theft coding, 4 speakers. Not available with Satellite Navigation.	○	○	○	○	●
DVD entertainment system – Model 7500 with roof-mounted, flip-down central screen, remote control, 2 sets of infrared headphones with dedicated stowage case, security coding and twin rear reading lights. Compatible with CD, MP3 and most game stations via dedicated ports					○
Satellite navigation stereo radio/CD – Becker Indianapolis (also plays MP3/WMA) - Not available with Bluetooth® Hands-Free Technology and Voice Control System).	○	○	○	○	○
Radio navigation system - Bosch Blaupunkt TravelPilot EX, MP3 compatibility, 4" monochrome display*	○	○	○	○	○
Portable Music Connection Socket - Allows connection of a portable music player to the car's audio system (not available with Durashift automatic transmission)	○	○	○	○	○
Bluetooth® Hands-Free Technology and Voice Control System (system without cradle). Does not include mobile phone.	○	○	○	○	○

● = Standard, ○ = Optional, at extra cost. * Available in 2006.

Interior features

	Style	Style Climate	Zetec	Zetec Climate	Fusion +
Carpet and trim					
Carpet – Non-woven velour	●	●	●	●	●
Carpet mats - front only					●
Door trim – Fabric insert, moulded panel with pull handle/armrest, front door bins with integral drink can recess and integrated speaker grilles	●	●	●	●	●
Gear lever gaiter – Black	●	●			
Gear lever gaiter – Black with satin aluminium gaiter surround insert			●	●	●
Gear knob – Black with gloss black acrylic insert (Durashift EST advanced manual transmission only)	●	●			
Gear knob - Black with gloss silver acrylic insert			●	●	●
Gear knob – Black leather-covered with gloss black acrylic insert (Durashift EST advanced manual transmission only)			●	●	●
Gear shift – Black (Durashift automatic transmission only)			●	●	●
Handbrake release button – Satin aluminium finish	●	●	●	●	●
Interior lighting					
Courtesy lights – Two, front- and centre-mounted, front door-operated (all door- and tailgate-operated) (Centre-mounted light is not available with the DVD entertainment system)	●	●	●	●	●
Courtesy lights – ‘Theatre-style’ dimming			●	●	●
Map reading lights			●	●	
Luggage compartment light	●	●	●	●	●
Instruments and controls					
Instruments – Speedometer, electronic digital engine temperature and fuel level gauges, tachometer and trip recorder	●	●	●	●	●
Warning indicators for oil pressure, direction indicators, glow plugs (diesel only), high beam, ignition/alternator, brake failure, handbrake on, airbags, low fuel level, ‘lights on’ audible warning	●	●	●	●	●

Durashift EST transmission

The Durashift EST transmission is the very latest in manual transmission technology. It combines an incredibly easy to use 5-speed manual mode with the option of automatic gear shifts. Available on all models (at extra cost).



Durashift 5-speed manual transmission

The Ford Fusion's Durashift 5-speed manual transmission offers quick, smooth gear changes, coupled with a light, hydraulically operated clutch.



ESP system

Using space-derived technology, the Electronic Stability Programme (ESP) system senses when the car is deviating from the driver's chosen line and automatically applies the necessary power and braking adjustments to correct its road position. Available on selected models (at extra cost).

— Vehicle with ESP.
— Vehicle without ESP.

- A** Vehicle experiences understeer on approach.
- B** Vehicle experiences oversteer on exit to bend.



Interior features

	Style	Style Climate	Zetec	Zetec Climate	Fusion +
Illuminated heater controls – 4-speed fan. Four vents with direction control	●	●	●	●	●
Control stalks – Column-mounted for high beam and flash headlights, indicators and wash/wipe functions	●	●	●	●	●
Vehicle Personalisation with Trip Computer (Standard with Durashift EST advanced manual transmission)			●	●	●
Battery saver	●	●	●	●	●
Steering wheel – 3-spoke, incorporating horn function	●	●	●	●	
Steering wheel – 3-spoke, leather-wrapped with silver effect spoke shell					●
Seats and seat belts					
Front seat – Driver’s manual 4- way adjust					●
Front seat - Driver’s seat armrest			●	●	●
Front seat – Passenger’s seat fold-flat function with integrated work surface/tray	●	●	●	●	●
Front seats – Anti-submarining, fully reclining with height-adjustable head restraints	●	●	●	●	●
Front seats – Fold forward seat backs	●	●	●	●	●
Rear seat – Split fold down seat	●	●	●	●	●
Rear seats – Head restraints on outer rear seats	●	●	●	●	●
Rear seat – Head restraint on centre seat	□	□	□	□	□
Seat belts – Front, lap and diagonal inertia reel with height-adjustable mounts	●	●	●	●	●
Seat belts – Rear, lap and diagonal inertia reel	●	●	●	●	●
Interior storage					
Centre console – Long with cup holder and open storage tray	●	●	●	●	●
Glovebox with lid (incorporating pen and ticket holders, slot for handbook pack and 8 coin slots)	●	●	●	●	●
Storage bin – Passenger’s seat, beneath flip-up cushion	●	●	●	●	●
Storage compartment – Central upper instrument panel-mounted with lid and rubber liner	●	●	●	●	●
Storage compartment – Driver’s side lower instrument panel-mounted with lid	●	●	●	●	●
Storage pockets – Driver’s seat cushion front and inner side bolster					●
Storage pockets – Driver’s seat back, fabric	●	●	●	●	●
Sunglasses holder – Driver’s side headliner-mounted (Not available with sunroof)			●	●	●
Comfort and convenience					
12V accessory socket – Front, centre console-mounted	●	●	●	●	●
12V auxiliary power point – Rear compartment, centre console-mounted with dust cover					●
Air conditioning – CFC-free with air recirculation		●		●	●
Air conditioning - CFC free with Electronic Automatic Temperature Control (EATC)		○		○	○

Interior features

	Style	Style Climate	Zetec	Zetec Climate	Fusion +
Pollen filter (Dealer-fitted option)	○	○	○	○	○
Clock – Digital, 12- or 24-hour function	●	●	●	●	●
Grab handle – Front passenger’s (not available with optional sunroof)	●	●	●	●	●
Grab handles – Rear with coat hooks	●	●	●	●	●
Mirror – Dipping rear-view	●	●	●	●	●
Smoker’s Pack – Front ashtray and cigar lighter	○	○	○	○	○
Sunroof – Tilting/sliding, screened glass	○	○	○	○	○
Sunvisor – Driver’s with covered mirror and ticket strap	●	●	●	●	●
Sunvisor – Passenger’s with covered mirror	●	●	●	●	●
Windows – Front, electrically-operated. Driver’s, with one touch lowering	●	●	●	●	●
Luggage compartment					
Carpet – Floor with sidewall and wheel arch trims	●	●	●	●	●
Carpet - Perimeter-bound with integral plastic rubbing strips					●
Rear parcel tray – Carpet-covered	●	●	●	●	●
Stowage hooks – Rear parcel tray support-mounted	●	●	●	●	●
Stowage hooks – Rear seat striker bar-mounted					●

● = Standard, ○ = Optional, at extra cost, □ = Part of an option pack, at extra cost.

Option packs

	Style	Style Climate	Zetec	Zetec Climate	Fusion +
Option packs					
Reflex Pack – Front side impact airbags and side curtain airbags, and rear centre head restraint	○	○	○	○	○
Electronic Stability Programme (ESP) (1.4 TDCi, 1.6 TDCi and 1.6 petrol only, not with Durashift EST or automatic transmissions). Includes front side impact airbags and side curtain airbags (deployed from the headlining) and rear centre head restraint			○	○	○
Rear parking distance sensor (Not available with tow bar)	○	○	○	○	○
Tow bar – Fixed	○	○	○	○	○
Tow bar - Detachable	○	○	○	○	○
Smoker’s Pack – Front ashtray and cigar lighter	○	○	○	○	○
Airbag – Front passenger’s airbag deactivation switch* (Dealer-fit accessory only)	○	○	○	○	○

○ = Optional, at extra cost.

*Note: A child seat should never be placed in the front passenger seat when the Ford vehicle is equipped with an operational front passenger’s airbag. The safest place for children is properly restrained on the rear seat.

Remote audio controls

Selected models feature remote audio controls on a stalk attached to the steering column, so you can adjust the sound system without taking your eyes off the road.



Rear power socket

A convenient, easy-to-use power source for phone chargers, car vacuum cleaners and other 12-volt electrical appliances.



DVD remote control

For remote control of the DVD entertainment system. Available on Fusion + (at extra cost).



DVD headphones

Infrared headphones make catching a movie on the DVD entertainment system a completely wireless affair. Available on Fusion + (at extra cost).





Explore the world of colour

It's not just the bold, expressive shape that helps the Ford Fusion to stand out from the crowd. The exciting palette of metallic and solid body colours is just as important.

From invigorating reds to soothing blues; luxurious silver to classic black. Whatever your taste, whatever your mood, you're sure to find a shade that's just right for you.

* Metallic body colours are available at extra cost.

The Ford Fusion is covered by the Ford Perforation Warranty for 12 years from the date of first registration. Subject to terms and conditions. Note: The car images used are to illustrate body colours only and may not reflect current specification. Colours and trims reproduced within this brochure may vary from the actual colours, due to the limitations of the printing processes used.

Model Fusion Style Climate
Options (at extra cost) Tonic
metallic paint.