



The Audi A6 allroad

Pricing and Specification Guide
Valid from May 2010

Personalising your Audi A6 allroad

This guide has been designed to help you tailor and price your Audi A6 allroad quickly and logically. At the back of this guide, you will also find information on CO₂ emissions-based vehicle excise duty and the other services offered by Audi, including Finance and Insurance. Alternatively, you can go to audi.co.uk and configure your Audi A6 allroad online.

The Audi A6 allroad

Efficiency	8
Engines	10
Transmission	11
quattro®	12

Model details and prices

Standard model equipment	14
Special Edition model equipment	16
Model prices	16

Audi exclusive

Colour and upholstery

Paint	20
Upholstery	22
Colour and trim guide	24
Inlays	28

Options

Wheels and tyres	30
Packages	32
Audio and communication	34
Seats	36
Safety and security	38
Interior equipment	40
Exterior equipment	42
Steering wheels and control packages	44
Service Plan and warranty	45
Merchandise	46

Technical details

Technical data	47
Dimensions	48
Additional information	49
Pricing information	51





Vorsprung durch Technik

Three words that express the very essence of Audi. Vorsprung durch Technik isn't a slogan. It's our way of seeing the world. It is the driving force behind our history of innovation that continues into the 21st century. Indeed, many technologies that Audi pioneered remain in our cars today. Some are milestones in the history

of the motorcar. From our beginnings in 1899, to the Auto Union team's Grand Prix successes in the 1930s and our more recent wins at Le Mans, we have always been at the forefront of the motor industry.

Vorsprung durch Technik makes us who we are. To see more of its influence, just read on.

The Audi A6 allroad

It's all in the name. The Audi A6 allroad is fit for all terrains – rugged or flat, town or country – thanks partly to the extraordinary road-holding of quattro® permanent all-wheel-drive. In the same way that our hands adjust to whatever we're holding, quattro® continuously adapts to suit the terrain. So it maintains the car's traction and stability, keeping you in control on the road – and, of course, off it.

The Audi A6 allroad comes with a comprehensive range of equipment as standard, including Milano leather upholstery, Bluetooth, adaptive air suspension and cruise control. There's also a wide selection of optional features, such as HDD Satellite Navigation, BOSE® sound system and the Rear Seat Entertainment Package, all of which you can choose when you place your order.





Efficiency

At Audi, doing less is something we're trying to do more of. We're working to use less fuel, release less CO₂ and waste less energy. It's why we've incorporated a number of more efficient technologies into the Audi A6 allroad.

Recuperation

When a vehicle brakes, the discs convert the kinetic energy into thermal energy, which is wasted as it cannot be used. With a recuperation system, like the one in the Audi A6 allroad, the kinetic energy is converted into useful electrical energy. The way it works is simple. While the car is coasting or braking, the alternator voltage is raised above the level of the basic electrical system, which enables the alternator to generate electrical energy and store it temporarily in the battery. When the vehicle accelerates, this energy is used to relieve the load on the alternator, resulting in a fuel saving of up to 3%.

TDI® and FSI®

Inside the engine of the Audi A6 allroad you'll find the same advanced fuel-injection technology that's driven us to win after win at Le Mans. With TDI® and FSI®, fuel is injected directly into the engine's chambers so that combustion is timed right down to the millisecond. As a result, waste is minimised and you get the most from every last drop of fuel.





Aerodynamics

A car's shape can have a big impact on its efficiency. It's why we've worked to make the Audi A6 allroad as aerodynamic as possible, including technology such as adaptive air suspension that responds to changes in speed. It means that the Audi A6 allroad becomes more aerodynamic at high speeds, while still offering good ground clearance in off-road situations.

Engines

Petrol

FSI® direct-injection technology is a unique Audi innovation that was originally developed for the Le Mans 24-hour endurance race to deliver more power and torque, as well as enhanced fuel efficiency. Precisely the right amount of fuel and air are injected into the combustion chambers, enabling the engine to 'breathe' more easily. It results in reduced heat loss and increased output, with around a 15% reduction in fuel consumption and significantly lower exhaust emissions. We've also developed TFSI®, with either turbocharging or supercharging, which combines FSI® technology with forced induction – giving cars an extra injection of power.

Diesel

We introduced TDI® to the roads in 1989, marking a departure from the noisy, fuel-thirsty diesel engines of the past. And since then, we've continuously refined it, recently developing common-rail technology. Under this system, a series of piezo injectors use electrical charge to precisely control the amount of fuel injected into the engine. As well as reducing noise, this allows combustion to happen at a lower temperature, with less oxygen, which lowers emissions.





Transmission

tiptronic

The 6-speed tiptronic transmission system is a form of automatic transmission available on Audi models with quattro® permanent all-wheel-drive. The technology converts high-torque engine power into both sporty performance and operating convenience, with crisp, fast gear changes, reduced weight and an optimised gearshift strategy. More spontaneous gear changes are a particular benefit, especially when down-shifting. Both in the 'D' (Drive) and 'S' (Sport) programme, the advanced electronics used in tiptronic respond efficiently to every driver input, helping to prevent unwanted upshifts when cornering.

quattro®

It's the technology that's given us the edge on the rally circuit ever since it was first introduced 30 years ago, bringing victory for the Audi quattro® on its very first outing. It's called quattro® permanent all-wheel drive. In this system, four permanently driven wheels deliver better acceleration, road-holding and safety, while asymmetric dynamic torque distribution intelligently controls the flow of power to the front and rear axles.

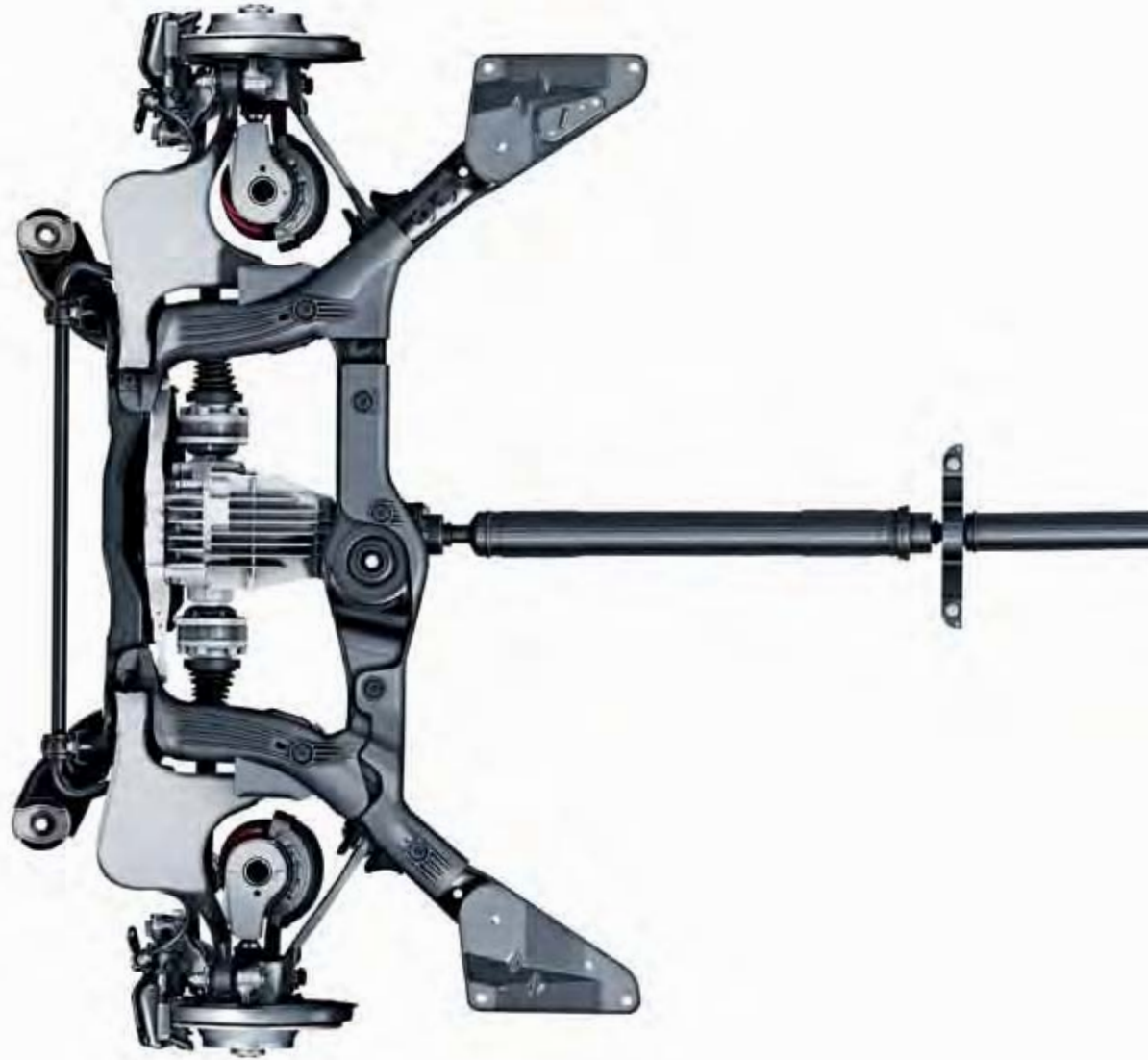

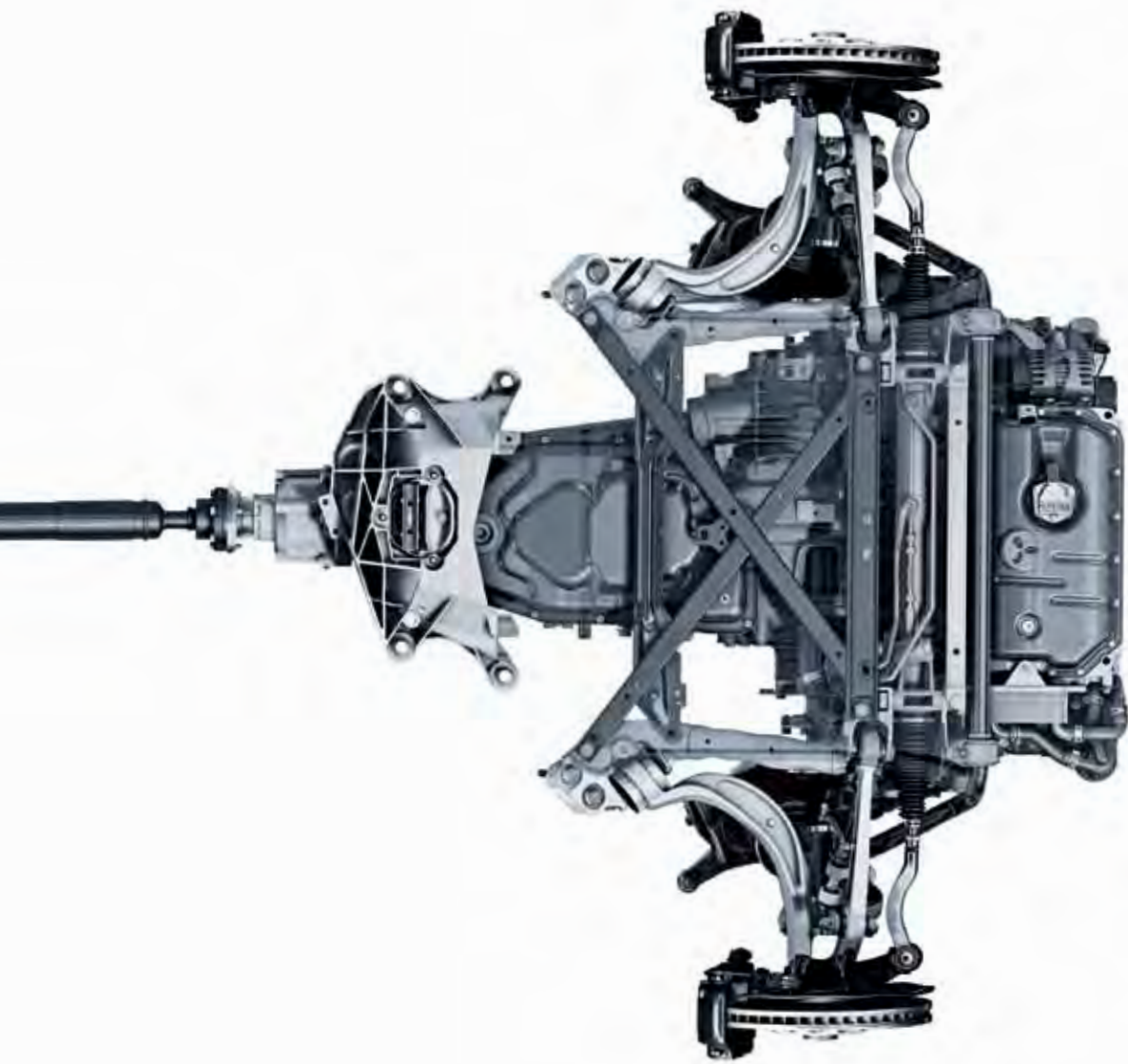

It means that the Audi A6 allroad can 'read' the road, sensing changes in the surface beneath the wheels and adjusting their grip accordingly. So when conditions get a little more demanding – in particular, when you go off-road – quattro® adapts, putting all the force of the Audi A6 allroad's engine precisely where it's needed to handle the change in terrain.

Standard model equipment

All A6 allroad models have the following items of standard equipment

Wheels, tyres and suspension

17" '7-arm Rotor' design alloy wheels with 225/50 R17 tyres

Adaptive air suspension with 5 modes (dynamic, automatic, comfort, allroad and lift)

Four-link front suspension

Spare wheel – collapsible with electric compressor

Audio and communication

MMI Radio Plus, including:

– FM/AM radio

– 10 speakers

– Single CD player

– DSP sound system

– 2 SD memory card readers

Mobile telephone preparation – Low with Bluetooth and voice control

Safety and security

Anti-lock Braking System (ABS) with EBD

Anti-Slip Regulation (ASR) traction control

Audi backguard head restraints for front seats (adjustable)

Brake light – third brake light in rear window

Brake system: disc brakes at front and rear, ventilated at front

Central locking with radio remote-control

Child locks, electric for rear doors and windows

Driver and front passenger two-stage airbags with front passenger airbag deactivation

Electronic Differential Lock (EDL) traction control

Electromechanical parking brake

Exit lights and active reflectors on all doors

Front fog-lights

Headlight washers

ISOFIX child-seat mounting (front-left and outer-rear seats)

Light and rain sensor including coming/leaving home function

Rear fog light

Servotronic steering – power steering with speed-dependent control

Side airbags for driver and front passenger

Side-impact protection in all doors

Sideguard head airbag system to protect front and outer-rear passengers in a side collision

Thatcham Category 1 alarm and immobiliser

Warning triangle

Seats

3-point seat belts for all seats

Milano leather upholstery

Split-folding rear seats

Interior equipment

4-spoke leather multi-function steering wheel (including gear-shift paddles on automatic models)

12V power socket in luggage compartment

12V power socket in rear centre console

Air vents with aluminium trim, 4 vents on the dashboard, 2 for the rear between the front seats, illuminated controls

Aluminium 'Axial' fascia and door trim inlays



4-spoke leather multi-function steering wheel



Scuff plates with metal inlays in 'allroad' design



Dual-zone electronic climate control

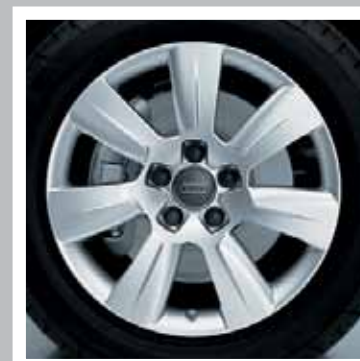

17" '7-arm Rotor' design alloy wheels

Aluminium look interior, on door handles, MMI control knob and gear lever

Ashtrays, illuminated, at the front of the centre console and in the rear doors

Auto-dimming rear-view mirror

Centre armrests, front and rear. Front-hinged with storage compartment

Cigarette lighter in front centre console

Coat hooks with cushioned action, two recessed in roof area

Compartment for glasses in front roof module

Cruise control

Cup holder within the centre console storage-compartment and a second cup holder beneath the front centre armrest

Driver's Information System (DIS)

Dual-zone electronic climate control

Electric front and rear windows

Floor mats (front and rear)

Illuminated vanity mirrors integrated into front sun visors

Load area comprising rail system, lashing points and folding load-area floor

Luggage compartment cover

Reading lights – two at front and two at rear

Scuff plates with metal inlays in 'allroad' design

Storage pack

Tool kit in luggage compartment

Exterior equipment

Body-coloured door mirrors, handles and bumpers

Daytime-running lights (halogen, LED in combination with Xenon Plus headlight option)

Electrically adjustable and heated door mirrors

Front grille in 'allroad' design with vertical chrome elements

Halogen headlights

Heated rear window

Heat-insulating glass

High-gloss pack with aluminium-look window and door-handle trims with gloss-black B-pillar

LED rear lights

Rear window wash/wipe

Roof rails in aluminium with unique 'allroad' design

Towing lugs at front and rear

Twin catalytic converters

Underbody protection in stainless steel

Visible Vehicle Identification Number (VIN)

Wheel arches and lower bumpers in contrasting design

Windscreen-washer jets, heated



A6 allroad Special Edition model equipment

In addition to Standard model equipment

Available on 3.0 TDI

Basic RRP
£808.51

Total RRP inc VAT
£950.00*



Light package

Wheels, tyres and suspension

19" '7-double-spoke' design
alloy wheels with 245/40 R19 tyres

Audio and communication

Technology package – Low with
CD changer (see page 32 for details)

Safety and security

Audi Acoustic Parking System – Rear

Interior equipment

Heated front seats

Light package

Exterior equipment

Full paint finish

Privacy glass



19" '7-double-spoke' design
alloy wheels

A6 allroad

Engines	Power	Transmissions	Basic RRP	Total RRP inc VAT	Recommended OTR
3.0 TFSI quattro	290PS	6-speed tiptronic	£34,289.36	£40,290.00	£41,475.00
2.7 TDI quattro	190PS	6-speed tiptronic	£32,493.62	£38,180.00	£39,240.00
3.0 TDI quattro	240PS	6-speed manual	£33,229.79	£39,045.00	£40,105.00
3.0 TDI quattro	240PS	6-speed tiptronic	£34,421.28	£40,445.00	£41,505.00

A6 allroad Special Edition

Engines	Power	Transmissions	Basic RRP	Total RRP inc VAT	Recommended OTR
3.0 TDI quattro	240PS	6-speed manual	£34,038.30	£39,995.00	£41,055.00
3.0 TDI quattro	240PS	6-speed tiptronic	£35,229.79	£41,395.00	£42,455.00

Transmissions

	6-speed tiptronic transmission
3.0 TFSI quattro	S
2.7 TDI quattro	S
3.0 TDI quattro	●
Basic RRP	£1,191.49
Total RRP inc VAT	£1,400.00

– = Not available ● = Available S = Standard

Please note: The maximum power output figures are quoted in PS (or Pferdestärke, which is the metric equivalent of brake horsepower). To convert to brake horsepower, divide the PS figure by 1.0139.

Recommended On-The-Road (OTR) retail prices include: delivery charge, half a tank of fuel, number plates at £580.00 (inc. VAT), Road Fund Licence (which may vary depending on model/transmission – see page 49 for details) and first registration fee at £55.00. Vehicle Excise Duty correct at time of going to print, but this may alter to reflect any change in the applicable VED rate.

RRP – Recommended Retail Price. VAT is calculated at 17.5% but this may alter to reflect any change in the applicable VAT rate.

*Valid for new vehicle orders placed up to and including 30 September 2010. Offers are subject to availability.



A6 allroad 3.0 TDI Special Edition

Audi exclusive



Audi exclusive

Every Audi is intrinsically exclusive. It's the breathtaking design, the exceptional engineering, the Vorsprung durch Technik. But for that special touch you can specify your new A6 allroad with options from Audi exclusive. Whether you want a unique, custom-mixed paint colour or seats in a combination of complementary shades, Audi exclusive will enable you to drive the car you've always imagined.

Both the exclusive and standard options can be found on the following pages.



Paint

Standard and optional colours

You can select one of the standard colours shown opposite or, for a different look, choose from a range of optional finishes.

Standard colours



Ibis white – T9

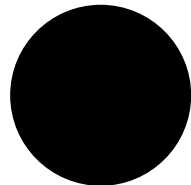

Brilliant black – A2

Optional colours

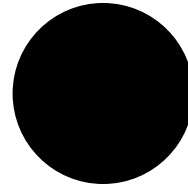

Phantom black, pearl effect – L8

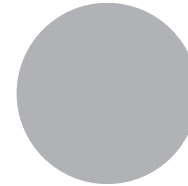

Ice silver, metallic – P5

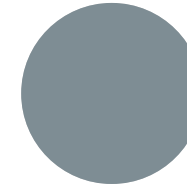

Quartz grey, metallic – Q4

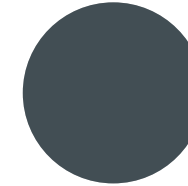

Condor grey, metallic – 5Q

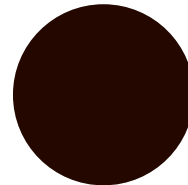

Teak brown, metallic – 4U

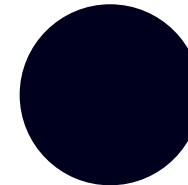

Night blue, pearl effect – 7X

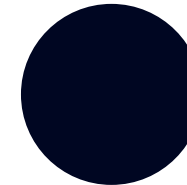

Aventurine blue, pearl effect – 7Y

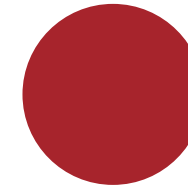

Garnet red, pearl effect – 9C

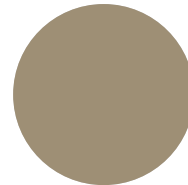

Dakar beige, metallic – 9X

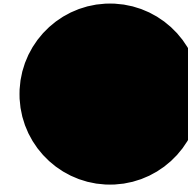

Lava grey, pearl effect – 1R

Options are subject to availability and may extend delivery.

All the colour swatches on this page are matched as accurately as possible to the actual paint colours used. However, due to print processes, Audi UK cannot guarantee that colours shown are 100% accurate.

Visit your local Audi Centre for a more accurate colour swatch.

RRP – Recommended Retail Price.

VAT is calculated at 17.5% but this may alter to reflect any change in the applicable VAT rate.

Optional colours

Basic RRP
£595.74

Total RRP inc VAT
£700.00

Paint

Audi exclusive

Everyone has a favourite colour. No matter what yours is, Audi exclusive provides a range of unique colours that have been designed to set your car apart. Choose from the swatches here, or specify any other paint colour in the Audi range – whether it's Jet blue from the Audi R8 or Alpine white from the original Audi quattro®. The choice is yours.

Customised

If you have a particular colour in mind, we'll mix the exact metallic or pearl-effect shade you want.*

Options are subject to availability and may extend delivery.

*Custom paint is subject to factory approval, and is available for metallic and pearl-effect water-based paints only. Three-colour process colours and two-tone schemes are not available.

**Visit your local Audi centre for colour samples.

All the colour swatches on this page are matched as accurately as possible to the actual paint colours used. However, due to print processes, Audi UK cannot guarantee that colours shown are 100% accurate.

Visit your local Audi Centre for a more accurate colour swatch.

RRP – Recommended Retail Price.

VAT is calculated at 17.5% but this may alter to reflect any change in the applicable VAT rate.

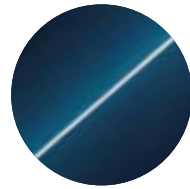

Palace blue, pearl effect

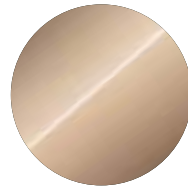

Sand beige, pearl effect

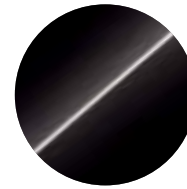

Saddle brown, pearl effect

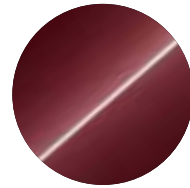

Classic red, pearl effect

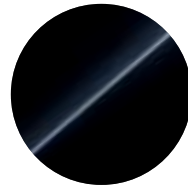

Mamba black, metallic

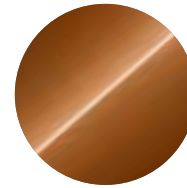

Ipanema brown, metallic



Any colour in the Audi range



100 Audi exclusive colours to choose from**



Customised paint

Audi exclusive

Basic RRP
£1,446.81

Total RRP inc VAT
£1,700.00

Customised

Basic RRP
£2,042.55

Total RRP inc VAT
£2,400.00

Upholstery

Standard seats

Choose your favourite upholstery from the swatches shown opposite to give your car's interior the look and feel you want.

Milano leather



Black – GD/RK

Valcona leather



Black – GD/RK

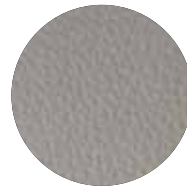

Pale grey – RX/RV

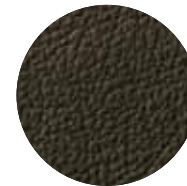

Paranut brown – RP/RN

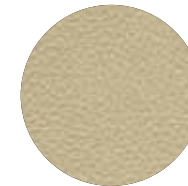

Cardamom beige – RT/RQ

A6 allroad	Special Edition	Basic RRP	Total RRP inc VAT
S	S	No charge	No charge
•	•	£255.32	£300.00

Options are subject to availability and may extend delivery.

- = Available
- = Not available
- S = Standard

Please note that the A6 allroad comes with a choice of 'velour' or 'fresco' carpet. Please see the colour and trim guide on page 24-25 for availability.

All leather upholstery choices include seats, head restraints, door inserts and front centre armrest (if fitted) in leather.

RRP – Recommended Retail Price.

VAT is calculated at 17.5% but this may alter to reflect any change in the applicable VAT rate.

Upholstery

Sports seats

Sports seats include 4-way electric lumbar support and manual height adjustment.

Options are subject to availability and may extend delivery.







- = Available
- = Not available
- S = Standard

Please note that the A6 allroad comes with a choice of 'velour' or 'fresco' carpet. Please see the colour and trim guide on page 24-25 for availability.

All leather upholstery choices include seats, head restraints, door inserts and front centre armrest (if fitted) in leather.

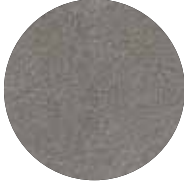
RRP – Recommended Retail Price.

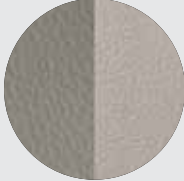
VAT is calculated at 17.5% but this may alter to reflect any change in the applicable VAT rate.

	A6 allroad	Special Edition	Basic RRP	Total RRP inc VAT
Milano leather  Black – GD/RK	•	•	£404.26	£475.00
Leather/Alcantara   Black – GD/RK Pale grey – RX/RV	•	•	£63.83	£75.00
Valcona leather     Black – GD/RK Pale grey/Star silver – RY/RW Paranut brown/Black – RM/RL Cardamom beige/Linen beige – RU/RS	•	•	£659.57	£775.00

Colour and trim guide

Interior trim colours

Standard seats – velour carpets

To help you choose the right interior for your new Audi A6 allroad, please use this guide, showing the carpet, dashboard and headlining colours that have been matched to your chosen upholstery.

Order Code	Upholstery	Carpet	Dashboard (upper/lower)	Headlining	Milano leather (N5W)	Valcona leather (N5D)
GD	Black	Black	Black	Silver	●	●
RP	Paranut brown	Black	Black	Silver	–	●
RT	Cardamom beige	Cardamom beige	Black	Linen beige	–	●
RX	Pale grey	Quartz grey	Black	Silver	–	●

Sports seats – velour carpets

Order Code	Upholstery	Carpet	Dashboard (upper/lower)	Headlining	Milano leather (N5W)	Leather/Alcantara (N7U)	Valcona leather (N5D)
GD	Black	Black	Black	Silver	●	●	●
RM	Paranut brown/Black	Black	Black	Silver	–	–	●
RU	Cardamom beige/Linen beige	Cardamom beige	Black	Linen beige	–	–	●
RY	Pale grey/Star silver	Quartz grey	Black	Silver	–	●	●

Options are subject to availability and may extend delivery.

- = Available
- = Not available
- S = Standard

Colour and trim guide

Interior trim colours

Standard seats – fresco carpets

Order Code	Upholstery	Carpet	Dashboard (upper/lower)	Headlining	Milano leather (N5W)	Valcona leather (N5D)
RK	Black	Black/Brown	Black	Silver	●	●
RN	Paranut brown	Black/Brown	Black	Silver	–	●
RQ	Cardamom beige	Light grey/Beige	Black	Linen beige	–	●
RV	Pale grey	Grey/Beige	Black	Silver	–	●

Sports seats – fresco carpets

Order Code	Upholstery	Carpet	Dashboard (upper/lower)	Headlining	Milano leather (N5W)	Leather/Alcantara (N7U)	Valcona leather (N5D)
RK	Black	Black/Brown	Black	Silver	●	●	●
RL	Paranut brown/Black	Black/Brown	Black	Silver	–	–	●
RS	Cardamom beige/Linen beige	Grey/Beige	Black	Linen beige	–	–	●
RV	Pale grey	Grey/Beige	Black	Silver	–	●	–
RW	Pale grey/Star silver	Grey/Beige	Black	Silver	–	–	●

Options are subject to availability and may extend delivery.

- = Available
- = Not available
- S = Standard

Upholstery

Audi exclusive

With Audi exclusive, you can specify your seats in Fine Nappa leather, leather/Alcantara or Valcona leather, in an array of different colours shown to the right.

Select just one all-over shade for each seat, or customise each panel in two or more complementary colours from the distinctive Audi exclusive palette. You can even choose the colour of the decorative stitching – to match or contrast with your chosen upholstery – from this varied collection. Whatever combination you decide upon, we think you'll be extremely comfortable with the result.

Options are subject to availability and may extend delivery.

- = Available
- = Not available
- S = Standard

*Leather and stitching colours (where applicable) can be specified in a variety of colours from the Audi exclusive range.

RRP – Recommended Retail Price.

VAT is calculated at 17.5% but this may alter to reflect any change in the applicable VAT rate.

Order Code		A6 allroad	Special Edition	Basic RRP	Total RRP inc VAT
PYA S3G	Audi exclusive leather package 1 in Fine Nappa leather. Includes leather-covered seat upholstery, door trim inserts and front centre armrest. Backrest covers and seat add-on parts come in the interior trim colour*	•	•	£2,297.87	£2,700.00
PYB S3G	Audi exclusive leather package 1 in Valcona leather. Includes leather-covered seat upholstery. Backrest covers and seat add-on parts come in the interior trim colour*	•	•	£2,808.51	£3,300.00
PYC S3G	Audi exclusive leather package 1 in Fine Nappa leather/Alcantara. Includes leather-covered seat side trims, head restraints and Alcantara seat centre sections. Backrest covers and seat add-on parts come in the interior trim colour*	•	•	£2,297.87	£2,700.00
PYD S3G	Audi exclusive leather package 2 in Fine Nappa leather. Includes all the contents of leather package 1 plus: leather-covered seat backrest covers, door armrests and handles. Seat side trims and add-on parts are colour coordinated	•	•	£5,106.38	£6,000.00
PYE S3G	Audi exclusive leather package 2 in Valcona leather. Includes all the contents of leather package 1 plus: leather-covered seat backrest covers, door armrests and handles. Seat side trims and add-on parts are colour coordinated	•	•	£5,531.91	£6,500.00
PYF S3G	Audi exclusive leather package 2 in Fine Nappa leather/Alcantara. Includes all the contents of leather package 1 plus: leather-covered seat backrest covers, door armrests and handles. Seat side trims and add-on parts are colour coordinated	•	•	£5,106.38	£6,000.00

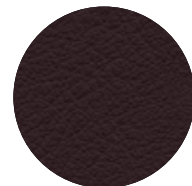

Chestnut brown



Jet grey



Alabaster white

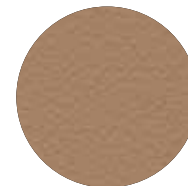

Sand beige

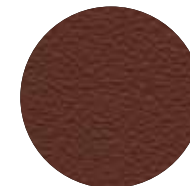

Saddle brown

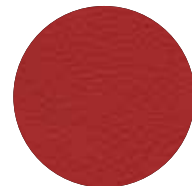

Crimson red



Magnolia white



Havana brown

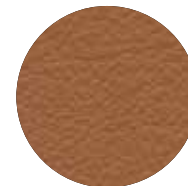

Cognac brown

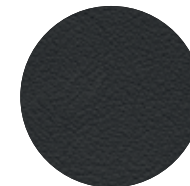

Night blue

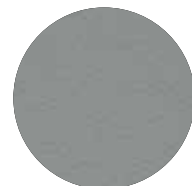

Cloudy grey

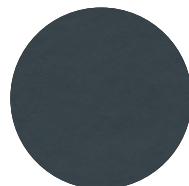

Smoky blue

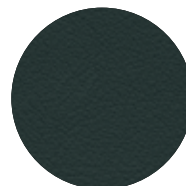

Iceland green

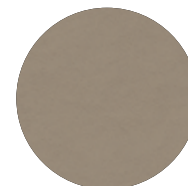

Powder beige



Classic red

Also available:

Alcantara colours: available in all the Audi exclusive colours shown, except for Crimson red, Jet grey and Sand beige. Alcantara equivalents are Chilli red, Amethyst grey, and Sesame beige respectively.

Please consult your Audi Centre for examples of Alcantara and carpet colours.



Inlays

Inlays are the all-important finishing touch that add flair and interest to your car's interior.

Order Code		A6 allroad	Special Edition	Basic RRP	Total RRP inc VAT
5TE	Aluminium trigon	•	•	£212.77	£250.00
5TW	Vavona wood, assam grey	•	•	£297.87	£350.00
7TC	Fine grain birch wood, beige	•	•	£297.87	£350.00
5MG	Walnut, brown	•	•	£297.87	£350.00
7TL	Fine grain ash, natural	•	•	£382.98	£450.00

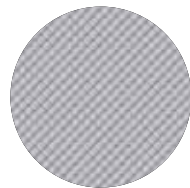

Aluminium trigon – **5TE**



Vavona wood, assam grey – **5TW**



Fine grain birch wood, beige – **7TC**



Walnut, brown – **5MG**

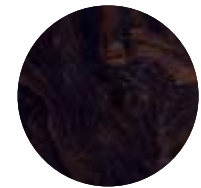

Fine grain ash, natural – **7TL**

Options are subject to availability and may extend delivery.

- = Available
- = Not available
- S = Standard

RRP – Recommended Retail Price.

VAT is calculated at 17.5% but this may alter to reflect any change in the applicable VAT rate.

Inlays

Audi exclusive

Audi exclusive has sourced a wide range of materials which you can select for your inlays, from Sepia oak to warm Saffron poplar.

Order Code		A6 allroad	Special Edition	Basic RRP	Total RRP inc VAT
YTA S3G	Audi exclusive inlays (cannot be combined with the inlays shown on page 28)	•	•	£978.72	£1,150.00
YTG S3G	Audi exclusive gear lever in wood (manual models, only available in combination with matching Audi exclusive inlays)	•	•	£153.19	£180.00
YTD S3G	Audi exclusive gear lever in wood (automatic models, only available in combination with matching Audi exclusive inlays)	•	•	£187.23	£220.00



Fine grain ash, nougat



Fine grain myrtle, nutmeg

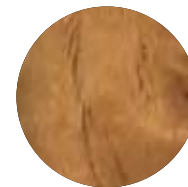

Poplar, saffron

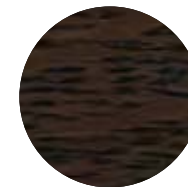

Oak, sepia

Options are subject to availability and may extend delivery.

- = Available
- = Not available
- S = Standard

RRP – Recommended Retail Price.

VAT is calculated at 17.5% but this may alter to reflect any change in the applicable VAT rate.

Wheels and tyres

Choose a set of specially-selected alloy wheels to subtly enhance the way your car looks and drives.



18" x 8J '10-spoke' design
alloy wheels - PRT



18" x 8J '5-arm Aero' design
alloy wheels - PRD



19" x 8.5J '20-spoke' design
alloy wheels - PQS

Wheels and tyres

Order Code		A6 allroad	Special Edition	Basic RRP	Total RRP inc VAT
PRT	18" x 8J '10-spoke' design alloy wheels with 245/45 R18 Y tyres	●	–	£723.40	£850.00
PRU	18" x 8J '10-spoke' design alloy wheels with 245/45 R18 Y all-terrain tyres. Includes enhanced engine undertray	●	–	£936.17	£1,100.00
		–	●	No charge	No charge
PRD	18" x 8J '5-arm Aero' design alloy wheels with 245/45 R18 Y tyres	●	–	£1,234.04	£1,450.00
PQS	19" x 8.5J '20-spoke' design alloy wheels with 245/40 ZR19 Y tyres	●	–	£1,489.36	£1,750.00
		–	●	No charge	No charge

Options are subject to availability and may extend delivery.

- = Available
- = Not available
- S = Standard

RRP – Recommended Retail Price.

VAT is calculated at 17.5% but this may alter to reflect any change in the applicable VAT rate.

Packages

Some items work well together, which is why we've created these special packages. They provide increased convenience and value by combining several of our most popular options.

Options are subject to availability and may extend delivery.

- = Available
- = Not available
- S = Standard

RRP – Recommended Retail Price.

VAT is calculated at 17.5% but this may alter to reflect any change in the applicable VAT rate.

Order Code	A6 allroad	Special Edition	Basic RRP	Total RRP inc VAT
PNW Technology package – Low. Satellite Navigation system – DVD-based with CD changer	●	--	£1,191.49	£1,400.00
	--	S	No charge	No charge

DVD Satellite Navigation. DVD-based route-planning and guidance with MMI control logic and 6.5" colour monitor, RDS radio, DVD-player for navigation system, audio or MP3 CDs. Includes European coverage disc

Order Code	A6 allroad	Special Edition	Basic RRP	Total RRP inc VAT
PNG Technology package – High. Satellite Navigation system – HDD-based with MMI 3G and CD changer	●	--	£1,617.02	£1,900.00
	--	●	£425.53	£500.00

HDD Satellite Navigation with MMI 3G. 3rd generation of MMI including 2 FM tuners, high resolution (800x400) 7" colour TFT display, DVD movie-playing function, colour Driver's Information System, 2 SD card readers and 40GB hard drive – 10GB of which can be used to store up to 4,000 songs. HDD Navigation functionality includes advanced speech recognition, 3D and topographical mapping display and advanced 3D building display



DVD Satellite Navigation display



Advanced 3D building display (part of HDD Navigation)



3D topographical mapping display (part of HDD Navigation)



Colour Driver's Information System



Audio and communication

Stay in touch using our range of communication functions, and give each journey its own soundtrack with our advanced audio equipment.

Options are subject to availability and may extend delivery.

- = Available
- = Not available
- S = Standard

RRP – Recommended Retail Price.

VAT is calculated at 17.5% but this may alter to reflect any change in the applicable VAT rate.

Order Code		A6 allroad	Special Edition	Basic RRP	Total RRP inc VAT
QV3	DAB digital radio. Integrated into MMI, receives digitally-transmitted radio stations in addition to the range of analogue stations. Displays music track, artist and radio program. Reception dependent on local digital network. Automatic switch from DAB to FM reception if the network signal is not strong enough. Only in combination with a technology package, High or Low	•	•	£293.62	£345.00
8RY	BOSE® surround sound system. Dynamic noise-compensation, 8-channel amplifier, 13 loudspeakers including centre speaker in the dashboard and 2 surround loudspeakers in the rear shelf. 5.1 surround sound. Total output of 330 Watts	•	•	£489.36	£575.00
9ZW	Mobile telephone preparation – High with Bluetooth. Provides handsfree connection using an external aerial for optimal reception via a Bluetooth interface. Please note that your mobile phone must have SIM-Access Profile facility for full functionality. Only in combination with technology package, High or Low	•	•	£191.49	£225.00
PT4	Mobile telephone preparation – High with Bluetooth privacy handset located in front centre armrest. The cordless handset allows passengers to make private calls, providing remote control of the telephone functions as well as a convenient SMS text message function. The handset is charged from a docking station integrated into the front centre armrest. The SIM card can be put directly in the handset if the mobile phone does not have SIM-Access Profile (SAP). Only in combination with technology package, High or Low	•	•	£446.81	£525.00
9WM	Rear Seat Entertainment Package. Includes two detachable DVD players/monitors fitted to the back of the front seats (supplied by Audi Genuine Accessories). The backs of the front seats are fitted with mountings and power connections. The system can be used outside the car with a rechargeable battery or mains power connection, which is included in the package. Includes individual remote controls and two sets of headphones	•	•	£846.81	£995.00



Audi Music Interface



BOSE® surround sound system



Mobile telephone preparation – High



DAB digital radio

Audio and communication

Order Code		A6 allroad	Special Edition	Basic RRP	Total RRP inc VAT
QV9	TV reception – analogue and digital. TV tuner for reception of 'free-to-air' TV channels. Picture display only possible on MMI screen when vehicle is stationary, audio available at all times. Reception is dependent upon local digital network availability. Only in combination with technology package – High	●	●	£680.85	£800.00
QU1	TV reception and DAB digital radio. Analogue and digital reception. Only in combination with technology package – High	●	●	£974.47	£1,145.00
UF7	Audi Music Interface (AMI). Universal connection for use with stereo audio sources, USB and MP3 devices including Apple iPod generation 4 onwards (iPod, iPod classic, iPod mini, iPod nano, iPod photo, iPod video, iPod touch). Provides intuitive control through the audio system and multi-function steering wheel. It also replicates the iPod display on the audio screen and DIS, including track titles. The interface provides charging function (dependent on device). Includes 2 cables to connect your iPod or USB MP3 player device	●	●	£212.77	£250.00
7A6	CD changer. For six CDs with MP3 compatibility. Operated via MMI system and located in glovebox	●	S	£255.32	£300.00
9Q4	Driver's Information System (DIS) – colour	●	S	£106.38	£125.00

Options are subject to availability and may extend delivery.

- = Available
- = Not available
- S = Standard

RRP – Recommended Retail Price.

VAT is calculated at 17.5% but this may alter to reflect any change in the applicable VAT rate.



Rear Seat Entertainment Package

Seats

Choose from a variety of different seat options so you can maintain the right driving posture at all times.

Options are subject to availability and may extend delivery.

- = Available
- = Not available
- S = Standard

RRP – Recommended Retail Price.

VAT is calculated at 17.5% but this may alter to reflect any change in the applicable VAT rate.

Order Code		A6 allroad	Special Edition	Basic RRP	Total RRP inc VAT
4A3	Heated front seats. Individually controlled variable temperature adjustment	•	-	£255.32	£300.00
4A4	Heated front and rear seats. Individually controlled variable temperature adjustment	•	-	£468.09	£550.00
		-	•	£212.77	£250.00
7P1	Electric lumbar support. For front seats with horizontal and vertical adjustment	•	•	£170.21	£200.00
PV1	Electrically-adjustable front seats. Includes adjustment for height, forwards and backwards position, backrest angle and lumbar support	•	•	£638.30	£750.00
	Sports seats	•	•	£468.09	£550.00
PV3	Electric front seats with driver's seat memory. Includes adjustment for height, forwards and backwards position, backrest angle and lumbar support. Also includes memory for door mirrors and electrically adjusted steering column, if fitted. Only in combination with memory mirrors	•	•	£936.17	£1,100.00
	Sports seats	•	•	£765.96	£900.00
PV6	Electric front seats with driver's and front passenger seat memory. Includes adjustment for height, forwards and backwards position, backrest angle and lumbar support. Also includes memory for door mirrors and electrically adjusted steering column, if fitted. Only in combination with memory mirrors	•	•	£1,063.83	£1,250.00
	Sports seats	•	•	£893.62	£1,050.00
3LE	Door armrest in leather	•	•	£178.72	£210.00
3X2	Through-load facility. Includes removable ski bag for transporting long objects	•	•	£136.17	£160.00



Door armrest in leather



Electric front seats



Sports seats in two-tone Valcona leather



Through-load facility with removable ski bag



Standard seats in Milano leather

Safety and security

Intelligent technology designed to give you better all-round awareness and safety on the road.

Options are subject to availability and may extend delivery.

- = Available
- = Not available
- S = Standard

RRP – Recommended Retail Price.

VAT is calculated at 17.5% but this may alter to reflect any change in the applicable VAT rate.

Order Code		A6 allroad	Special Edition	Basic RRP	Total RRP inc VAT
7X1	Acoustic parking system (rear only). Aids parking by acoustically indicating distances to obstacles	•	S	£280.85	£330.00
7X4	Audi parking system plus. Aids parking by acoustically and visually indicating distances to obstacle	•	-	£553.19	£650.00
		-	•	£272.34	£320.00
7X8	Audi parking system advanced. Aids parking by acoustically and visually indicating distances to obstacles with guiding lines. Measured by sensors and reversing camera. Only in combination with technology package	•	-	£808.51	£950.00
		-	•	£527.66	£620.00
PU1	Audi lane assist. Uses a discreet camera mounted at the top of the windscreen to monitor the road ahead. The driver is warned via a vibration of the steering wheel if the vehicle is about to exit the lane unintentionally. Only in combination with 4-spoke multi-function steering wheel	•	•	£340.43	£400.00
7Y1	Audi side assist. Aids the driver when changing lane. Audi side assist monitors the area behind your car, using radar sensors located discreetly in the rear bumper, informing the driver with a visual warning signal in the door mirror if there is a vehicle in their blind spot or approaching quickly from behind. The system is activated using a button on the driver's door	•	•	£382.98	£450.00
PU2	Audi side assist and lane assist. Only in combination with a 4-spoke multi-function steering wheel	•	•	£723.40	£850.00



Audi parking system plus



Audi parking system advanced



Audi lane assist



Privacy glass

Safety and security

Order Code		A6 allroad	Special Edition	Basic RRP	Total RRP inc VAT
4L7	Auto-dimming rear view mirror with digital compass. Not available in combination with High-beam assist	•	•	£68.09	£80.00
6XE	Door mirrors – electrically folding	•	•	£106.38	£125.00
PAK	Door mirrors – electrically folding and auto-dimming	•	•	£212.77	£250.00
PAH	Door mirrors – electrically folding and auto-dimming with memory function. Only in combination with electric front seats with memory function	•	•	£212.77	£250.00
1T3	First-aid kit	•	•	£17.02	£20.00
4KF	Privacy glass. Dark tinted glass from B-pillar backwards	•	S	£276.60	£325.00
4X4	Rear side airbags. Situated in side of rear seats	•	•	£255.32	£300.00
7K6	Tyre pressure loss indicator. A visual and acoustic warning when the system detects a potential loss of tyre pressure	•	•	£72.34	£85.00

Options are subject to availability and may extend delivery.

- = Available
- = Not available
- S = Standard

RRP – Recommended Retail Price.

VAT is calculated at 17.5% but this may alter to reflect any change in the applicable VAT rate.



Interior equipment

Specify every detail of your car's interior with this extensive range of options.

Options are subject to availability and may extend delivery.

- = Available
- = Not available
- S = Standard

*HomeLink® is a registered trademark of Johnson Controls. For information on compatibility, visit www.homelink.com.

RRP – Recommended Retail Price.

VAT is calculated at 17.5% but this may alter to reflect any change in the applicable VAT rate.

Order Code		A6 allroad	Special Edition	Basic RRP	Total RRP inc VAT
4F2	Advanced key. Access and authorisation system which automatically exchanges data between key and vehicle, allowing the driver to keep the key in their pocket or bag at all times. To unlock and open, simply lift the exterior door handle. To lock, press the button on the handle. Pressing the Start/Stop button integrated in the centre console starts and stops the engine	•	•	£680.85	£800.00
VC1	Garage door opener (Homelink®*). Programmable radio-operated remote control for compatible doors/gates. Control buttons integrated in the front roof module	•	•	£161.70	£190.00
QQ1	Interior light package. Illumination of the area below the wing mirrors, ambient lighting of the centre console using red LED technology, ambient lighting of the door panels at the front and rear, active reflectors in front and rear doors, footwell lighting using LED technology and entry and exit lights at the front and rear	•	S	£191.49	£225.00
3GN	Load-area fixing kit. Includes telescopic bar and securing belt for dividing up luggage compartment	•	•	£106.38	£125.00
4Y2	Load-area lockable side compartment. Includes storage compartment cover to right of luggage area which is lockable with vehicle key	•	•	£34.04	£40.00
6SJ	Reversible load floor mat. Luggage compartment floor mat can be reversed to provide a rubber mat which extends to protect rear bumper	•	•	£63.83	£75.00
3Y1	Rear window blind – manual	•	•	£85.11	£100.00
3Y3	Rear window and side window blinds – manual	•	•	£170.21	£200.00
6Q6	Aluminium gear knob. Manual models only	•	•	£106.38	£125.00
6NQ	Cloth headlining – black. Only in combination with black upholstery	•	•	£170.21	£200.00



Advanced key (Start/Stop button)



Load-area fixing kit



Rear window blind, manual



Reversible mat for luggage compartment

Interior equipment

Order Code		A6 allroad	Special Edition	Basic RRP	Total RRP inc VAT
YSR S3G	Audi exclusive floor mats with leather piping. Includes 4 floor mats for front and rear (cannot be combined with option YSQ/S3G – Audi exclusive carpets)*	●	●	£323.40	£380.00
YSQ S3G	Audi exclusive carpets. Includes 4 Audi exclusive floor mats with leather piping (cannot be combined with option YSR/S3G – Audi exclusive floor mats)*	●	●	£1,446.81	£1,700.00
YSN S3G	Audi exclusive leather-covered cockpit on driver's side (available in black leather only)	●	●	£765.96	£900.00
YTO S3G	Audi exclusive seat belts*	●	●	£1,276.60	£1,500.00
YSO S3G	Audi exclusive leather-covered dashboard with contrast stitching**	●	●	£1,276.60	£1,500.00

Options are subject to availability and may extend delivery.

- = Available
- = Not available
- S = Standard

*The colour of the leather, seat belts, stitching and piping (where applicable) can be selected from any of the exclusive colours shown on page 26. The carpet colour can also be selected from any of the exclusive colours shown on page 26, except for Crimson red and Saddle brown.

**Dashboard can be specified in Chestnut brown, Palace blue, Saddle brown, Havanna brown, Jet grey or Crimson red.

RRP – Recommended Retail Price.

VAT is calculated at 17.5% but this may alter to reflect any change in the applicable VAT rate.



Exterior equipment

Make sure your car looks exactly as you want it to by selecting some of our striking options.

Options are subject to availability and may extend delivery.

- = Available
- = Not available
- S = Standard

RRP – Recommended Retail Price.

VAT is calculated at 17.5% but this may alter to reflect any change in the applicable VAT rate.

Order Code		A6 allroad	Special Edition	Basic RRP	Total RRP inc VAT
8N7	High-beam assist. Automatically adjusts headlights from high-beam to dipped-beam when another vehicle is approaching. Not available in combination with auto-dimming rear-view mirror with digital compass	•	•	£93.62	£110.00
PX4	Xenon Plus headlights. Includes LED daytime-running lights, automatic headlight adjustment and dynamic range control	•	•	£595.74	£700.00
PX4 8Q5	Adaptive headlights. Swivelling headlights for improved illumination of a winding road. Includes Xenon Plus headlights with LED daytime-running lights and headlight washers. Also includes kerb lights	•	•	£914.89	£1,075.00
2Z7	Deletion of engine technology designation at rear	•	•	No charge	No charge
2Z0	Deletion of model and engine technology designation at rear	•	•	No charge	No charge
PGA	Electrically operated boot lid. Opens and closes the boot lid electrically. Opened via radio-operated remote car key, button in the driver's door or the soft-touch button in the boot-lid recess. Closed by pressing the button on the inside of the boot lid	•	•	£340.43	£400.00
3FE	Electric slide-and-tilt sunroof. Includes position pre-selection, tinted glass insert, variable sunshield and convenience closing	•	•	£723.40	£850.00
3FR	Electric slide-and-tilt solar-panel sunroof. Includes position pre-selection and convenience closing. Uses the sun's energy to supply a constant flow of air to reduce the temperature inside a parked car	•	•	£1,000.00	£1,175.00



Adaptive lights with LED daytime-running lights



Model designation shown on boot lid

Exterior equipment

Order Code		A6 allroad	Special Edition	Basic RRP	Total RRP inc VAT
VJ1	Full paint finish. Bumpers are painted in body colour with matt finish	●	S	£468.09	£550.00
PZH	Power door closure. Electrically-operated power doors with soft-close feature	●	●	£361.70	£425.00
1D4	Towing equipment. Manual and swivelling	●	●	£638.30	£750.00
PDG	Twin-pane UV and heat-insulating glass	●	●	£723.40	£850.00



Steering wheels and control packages

You can choose from a selection of advanced leather multi-function steering wheels, allowing you to control your audio system at the touch of a button.

Options are subject to availability and may extend delivery.

- = Available
- = Not available
- S = Standard

*The colour of the leather and stitching (where applicable) can be selected from any of the exclusive colours shown on page 26.

RRP – Recommended Retail Price.

VAT is calculated at 17.5% but this may alter to reflect any change in the applicable VAT rate.

Order Code		A6 allroad	Special Edition	Basic RRP	Total RRP inc VAT
1XW	3-spoke multi-function steering wheel – manual models only	•	•	£85.11	£100.00
1XX	3-spoke multi-function steering wheel with gear-shift paddles – tiptronic models only	•	•	£85.11	£100.00
2ZM	Heated 4-spoke multi-function leather steering wheel – manual models only	•	•	£136.17	£160.00
2ZD	Heated 4-spoke multi-function leather steering wheel with gear-shift paddles – tiptronic models only	•	•	£136.17	£160.00
6F9	Wood and leather 4-spoke multi-function steering wheel with gear-shift paddles. Includes wooden gear knob. Only in combination with Walnut or Fine grain birch wood inlays	•	•	£200.00	£235.00
2C7	Electrically adjustable steering column. Includes adjustment for height and reach and easy-exit function	•	•	£255.32	£300.00
YRH S3G	Audi exclusive leather-covered steering wheel*	•	•	£314.89	£370.00
YRB S3G	Audi exclusive controls package – includes leather covered steering wheel and gear shift gaiter*	•	•	£493.62	£580.00
YRI S3G	Audi exclusive steering wheel in wood and leather. Wood and leather can be chosen from the Audi exclusive inlays and leather colours respectively. Only available in combination with Audi exclusive inlays*	•	•	£612.77	£720.00



Service Plan

Choosing an Audi Service Plan provides an easy way to cover all your car's scheduled servicing with a convenient monthly payment plan. It can take care of everything from fluid and filter changes to your full service, ensuring you retain a full Audi service history. There are no servicing bills to plan for and you'll continue to benefit from today's prices for the length of your agreement.

Order Code		Payment Method	A6 allroad	Special Edition	Basic RRP	Total RRP inc VAT
-	3-Service Plan. Comprehensive package covering servicing costs for 3 services or 30,000 miles (whichever occurs sooner). Visit audi.co.uk/serviceplans for full details including terms and conditions	Monthly Direct Debit*	●	●	£34.04	£40.00
-	5-Service Plan. Comprehensive package covering servicing costs for 5 services or 50,000 miles (whichever occurs sooner). Visit audi.co.uk/serviceplans for full details including terms and conditions	Monthly Direct Debit*	●	●	£42.55	£50.00

Warranty

Options are subject to availability and may extend delivery.

- = Available
- = Not available
- S = Standard

*Prices are based on the Audi Fixed Inspection Service Schedule and 10,000 miles per annum or less. For more information on the Service Schedule, please see page 49.

**Only available when ordering your new A6 allroad. Please speak to your Audi Centre for full details.

RRP – Recommended Retail Price.

VAT is calculated at 17.5% but this may alter to reflect any change in the applicable VAT rate.

Order Code		Payment Method	A6 allroad	Special Edition	Basic RRP	Total RRP inc VAT
-	Audi Warranty, covering you for unlimited mileage in the first two years of ownership, and up to 60,000 miles in the third year. Transferable between owners**		S	S	No charge	No charge
EA6	Audi Warranty, covering you for up to 4 years or 75,000 miles, whichever comes soonest. Cover includes a two-year unlimited mileage warranty, and up to 75,000 miles in the third and fourth years. Transferable between owners**		●	●	£463.83	£545.00
EA9	Audi Warranty, covering you for up to 5 years or 90,000 miles, whichever comes soonest. Cover includes a two-year unlimited mileage warranty, and up to 90,000 miles in the third, fourth and fifth years. Transferable between owners**		●	●	£1,114.89	£1,310.00

Merchandise

From the enthusiasts' motorsport collection to the sophisticated Audi collection, there's a wide variety of adults' and children's clothing, lifestyle accessories and collectables, all of which bear the Audi name.

Please speak to a member of our team at your local Audi Centre to see the full Audi collection and to place an order. A selection of Audi merchandise is also available to buy from audi.co.uk/merchandise.



Audi kids



Bags and leather goods



Clothing



Motorsports



Sport and travel



Model cars

A6 allroad technical data

Engine	Petrol	Diesel		3.0 TDI quattro
	3.0 TFSI quattro	2.7 TDI quattro	3.0 TDI quattro	
Transmission	6-speed tiptronic	6-speed tiptronic	6-speed manual	6-speed tiptronic
Cylinder	V6	V6	V6	V6
Displacement, cubic cm	2995	2698	2967	2967
Max. power, ¹ PS at rpm	290/4850	190/3500	240/4000	240/4000
Max. torque, Nm at rpm	420/2500	450/1750	450/1750	500/1750
0-62mph acceleration, seconds	6.3	8.8	7.2	7.4
Top speed, ² mph	155*	135	144	144
CO ₂ emissions, ³ g/km	225	199	189	199
Benefit in kind (BIK)%	34%	31%	29%	31%
Fuel consumption, mpg (l/100km) Urban	21.2 (13.3)	28.5 (9.9)	30.1 (9.4)	29.1 (9.7)
Fuel consumption, mpg (l/100km) Extra Urban	37.2 (7.6)	45.6 (6.2)	47.9 (5.9)	45.6 (6.2)
Fuel consumption, mpg (l/100km) Combined	29.1 (9.7)	37.7 (7.5)	39.2 (7.2)	37.7 (7.5)
ABI insurance group 1-50**	39 E	32 E	34 E	34 E
Unladen weight, ⁴ kg	1840	1870	1865	1880
Gross weight limit, kg	2470	2500	2495	2510
Roof load limit/nose weight, kg	100/85	100/85	100/85	100/85
Max trailer load unbraked, ⁵ kg	750	750	750	750
Max trailer load with 12% gradient, ⁵ kg	1900	1900	1800	1900
Max trailer load with 8% gradient, ⁵ kg	2100	2100	2100	2100
Luggage compartment capacity, rear seats upright, litres	565	565	565	565
Luggage compartment capacity, rear seats folded, litres	1660	1660	1660	1660
Fuel tank capacity approx, litres	80	80	80	80

*Electronically limited.

**Highest insurance group rating shown. Group may be lower dependent on trim level. Please visit www.thatcham.org/abigrouprating for details.

All diesel engines are fitted with a Diesel Particulate Filter.

¹The given value was obtained in accordance with the specified measurement procedure (the respective current version of the Directive 80/1269/EEC).

²Top speed is achieved in top gear

³The given values were calculated in accordance with the specified measurement procedure (the respective current version of Directive 80/1268/EEC). This information does not relate to a single vehicle and does not comprise part of the offer but is merely intended for the purpose of comparison between the different vehicle types.

⁴Vehicle's unladen weight without driver (calculated in accordance with the current version of Directive 80/1268/EEC). The fitting of additional equipment may increase the vehicle's unladen weight and drag coefficient, whereupon the potential carrying capacity and top speed will be correspondingly reduced.

⁵The engine's power output always goes down with increasing altitude. At 1,000m above sea level, and for every additional 1,000m, deduct 10% from the weight of the outfit (trailer load limit + gross weight of the towing vehicle).

Please note: The maximum power output figures are quoted in PS (or Pferdestärke, which is the metric equivalent of brake horsepower). To convert to brake horsepower, divide the PS figure by 1.0139.

A6 allroad dimensions

The technical drawings opposite show the exact dimensions of the A6 allroad, so you can check everything – from whether the car will fit in your garage to whether your luggage will fit in the boot.

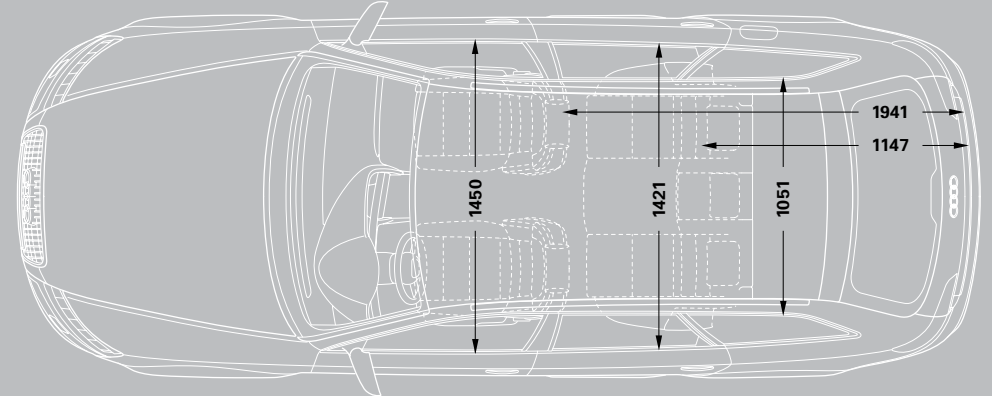
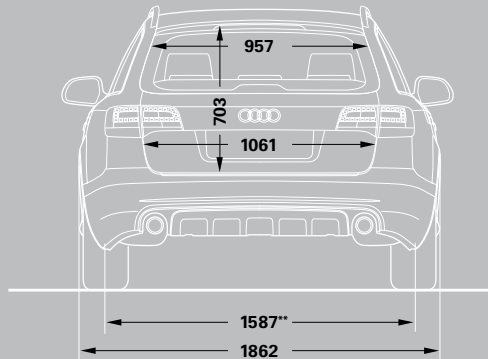
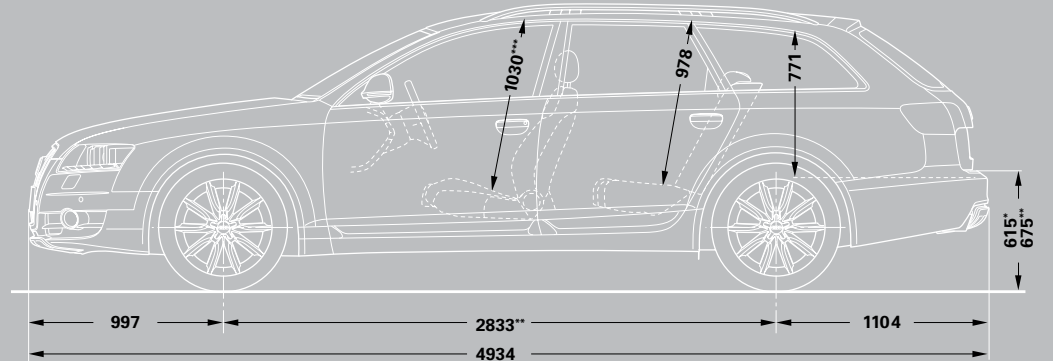
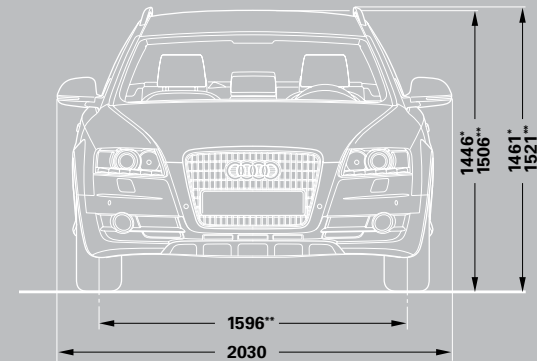

Dimensions were measured with vehicle at unladen weight.

Turning circle approx 11.9m.

Dimensions in millimetres.

- * Dynamic mode
- ** Lift mode
- *** Maximum headroom

Additional information

CO₂ data and information

CO₂ emissions-based Vehicle Excise Duty

Vehicle Excise Duty (Road Fund Licence) is based upon the amount of Carbon Dioxide (CO₂) a vehicle emits, measured in grams per kilometre (g/km). The DVLA has created thirteen categories:

Petrol and Diesel engines

A - up to 100g/km	£0.00
B - 101 to 110g/km	£0.00
C - 111 to 120g/km	£0.00
D - 121 to 130g/km	£0.00
E - 131 to 140g/km	£110.00
F - 141 to 150g/km	£125.00
G - 151 to 165g/km	£155.00
H - 166 to 175g/km	£250.00
I - 176 to 185g/km	£300.00
J - 186 to 200g/km	£425.00
K - 201 to 225g/km	£550.00
L - 226 to 255g/km	£750.00
M - over 255g/km	£950.00

Vehicle Excise Duty (VED) rates correct at time of going to print, but these may alter to reflect any change in the applicable VED rate

Servicing tailored to your needs

Regular servicing is key to safeguarding your Audi's performance and a full Audi service history could help you preserve the future re-sale value. To make servicing easy, the Audi Service Schedules have been designed to work with your individual driving style and vehicle.

There are two schedules available and your Audi Centre will advise which schedule is most suited to your needs. The conventional fixed Audi Inspection Service Schedule has fixed intervals for the Oil-change and Inspection Service that are based on time

and distance, whichever comes first. With the Audi LongLife Service Schedule, sensors take account of driving style and conditions in which the vehicle is used to indicate when the Oil-change Service is required. Oil-change Service intervals are therefore variable and are conveniently indicated via the on-board service interval display.

Fixed Inspection Service Schedule

	Vehicle usage:
Mileage	Less than 10,000 miles per annum
Type of journey	Mainly city/town centre driving. Short journeys
Conditions	Frequent cold starts. High engine loading – e.g. frequent hill climbs, vehicle fully loaded, towing
Driving style	Uneconomical – e.g. heavy acceleration, heavy braking, constant changes in speed, constant use of high revs, 'sporty' driving
	Service Intervals:
Oil-change Service	Fixed to every 9,000* miles/1 year
Inspection Service	Fixed to every 19,000* miles/2 years

Variable LongLife Service Schedule

	Vehicle usage:
Mileage	More than 10,000 miles per annum
Type of journey	Motorway and main road driving. Mainly longer distance journeys. Constant speeds
Conditions	Normal engine loading – e.g. with little or no towing, with little or no hill climbs. Normal vehicle loading
Driving style	Moderate acceleration, moderate braking, engine revs mainly below 3,000
	Service Intervals:
Oil-change Service	Variable to a maximum of every 19,000* miles/2 years
Inspection Service	Fixed to every 19,000* miles/2 years

*As indicated by the service interval display. Mileages are approximate as the Service Indicator system uses kilometres as its distance measurement.

Additional information

Welcome to Audi

By placing an order for your Audi, you're choosing to get behind the wheel of one of the most sophisticated cars on the road. And because we believe the service we offer should be just as advanced, we wanted to let you know exactly what you can expect from us, now and in the future.

We've agreed a set of standards with all our Centres, which governs the way we do business with you. It outlines the kind of service we promise to deliver for every customer, right down to filling each new Audi we sell with half a tank of fuel.

So whether you're interested in the date your car will arrive in the UK or the way we'll dispose of non-biodegradable materials after we service your Audi, you can have total confidence in us.

Audi Promise

Audi Centres

We guarantee that all of our Centres will be open as follows;

Sales: Monday to Friday 9am–6pm
Saturday 9am–5pm

Service: Monday to Friday 8am–6pm
Saturday 8.30am–1pm

Sunday opening is at local discretion.

New car delivery

Once we've confirmed a delivery date for your car, we'll keep you informed of progress. Subject to reasonable notice, we'll then deliver it to a place of your choice, whether that's your home or place of work. In the unlikely event of a delay, we'll provide a courtesy car to minimise inconvenience and keep you mobile.

The experts in Vorsprung durch Technik

Would you entrust your Audi to anyone who hasn't been regularly trained to Audi standards? Our network of Audi Approved Master Technicians have undergone an impressive 100,000 hours of training over a 10-year programme to ensure they have the latest technical expertise for maintaining and servicing your Audi. All of our Service Advisors undergo a specialist induction and training to ensure they are Audi professionals and able to talk to you about any issues you may have with your Audi vehicle. What's more, we have so much expertise and experience in looking after Audi vehicles that we are able to make a note of your mileage and the state of your vehicle as and when we see it and predict when certain key events may occur. As part of our commitment to you, we will notify you in plenty of time so you can make an appointment with us.

Your convenience comes first

At Audi you can choose from a range of convenient services that suit your needs. Why not book a 'service while you wait' appointment* and enjoy our complimentary refreshments while your car is with us? Or, if you need to be mobile, take advantage of one of our courtesy cars which we can even collect and deliver to you.* We guarantee we can service your Audi within 5 days without a courtesy car, or within 10 days if you need transport. We will also ensure your car is returned to you with a full valet.

Audi Genuine Parts

Would you put a part into your Audi that wasn't the same quality as the factory-fitted original? You can rest assured that only Audi Genuine Parts will be used on your vehicle. What's more, Audi parts and labour come with a 2-year guarantee.** We stock a wide variety of parts, so we are well covered. However, if we don't have a part in stock at our Centre we have the back-up of parts at other Audi Centres, at our national warehouse and our factory and can usually source the relevant part very quickly.

We don't like surprises either

We believe strongly in transparency and there will be no hidden costs. For added peace of mind, we will give you a quotation over the phone for the work you have requested and email you the price confirmation. We'll consult you if any additional work on your car is needed when it is with us. We won't carry out any extra work without asking your permission first.

The Audi Stamp

Regular servicing is key to safeguarding your Audi's performance and a full Audi service history could help you preserve the future re-sale value of your car. Only the Audi Stamp will prove your approved Audi service history.

Getting better every time

Audi continually gather feedback from our highly trained Technicians and our customers to ensure our vehicles are running as they should. If necessary, we use this feedback to make improvements (in the form of software updates) to help maintain the durability, performance, efficiency and safety you would expect from our cars. These updates will also ensure certain retrofitted products are correctly installed and function correctly (tow bar fitting changes the torque characteristics of your engine, for example). We ensure these are loaded onto your vehicle each and every time it's in our workshop.

Environmental commitment

We promise to dispose of all non-biodegradable materials from your vehicle in a responsible manner

*Subject to availability.

**Excludes wear and tear.

Pricing information

Pricing

Prices and specifications given are correct at the time of printing. Always check details with your Audi Centre, as Audi policies are continually developing. We reserve the right to change prices or specifications at any time.

All prices are subject to VAT, currently charged at 17.5% but this may alter to reflect any change in the applicable VAT rate.

Delivery charges and number plates are not included in the vehicle price.

Delivery charge	£473.62
Number plate	£20.00
VAT	£86.38
Total	£580.00

Audi Roadside Assistance

Your new car comes complete with 3 years' complimentary roadside assistance and recovery across the UK provided by RAC Motoring Services. Also included is roadside assistance throughout Europe, managed by RAC Motoring Services.

For further information and terms and conditions, please visit audi.co.uk

Audi Customer Care

Every new Audi benefits from the comprehensive Audi Customer Care Package, which comprises:

- ▶ A 3-year Audi warranty, which covers you for unlimited mileage in the first 2 years of ownership, with a full mechanical and electrical warranty which covers you for up to 60,000 miles in the 3rd year

- ▶ A 3-year paint warranty
- ▶ A 12-year anti-corrosion warranty
- ▶ 3 years' UK roadside assistance and recovery

You also have the option when ordering your new car of choosing a four-year or five-year Audi warranty. Speak to a member of the sales team for more information.

Audi Tax-Free Sales

If you are entitled to purchase a vehicle free of VAT, normally through Military or Diplomatic privilege, please contact your local Audi Centre for full details.

Should you have any difficulty obtaining the information you require, please call Freephone 0800 585878.

Audi Finance

Audi Finance specialise in providing funding solutions for Audi drivers. Whether your Audi is for private or business use, there are a range of funding options to choose from

Below is the full range of finance products.

- ▶ Solutions – a Personal Contract Plan
- ▶ Hire purchase
- ▶ Lease purchase
- ▶ Finance lease
- ▶ Contract hire

With all products, you can choose a fixed-cost maintenance plan designed to help you budget accurately.

No matter what Audi model you choose, your local Audi Centre can provide you with a personalised quote which could fit your budget and motoring needs.

Audi Finance is a trading name of Volkswagen Financial Services (UK) Limited. An offer of finance depends on certain conditions. Available to people over 18 in the UK only.

Audi Insurance

We want you to start enjoying your new car from day one and thanks to Audi Insurance complimentary seven day cover, you can. Call free on 0800 316 7893 (lines are open Monday to Friday 8am - 9pm, and Saturday 9am - 5pm), provide a few details and a cover note will be sent to your Audi Centre. They will then tax your car and you can drive it away.

Audi Insurance is a trading name of Volkswagen Insurance Service (Great Britain) Limited, an appointed representative of Volkswagen Financial Services (UK) Limited, Brunswick Court, Yeomans Drive, Blakelands, Milton Keynes MK14 5LR. Registered in England number 2835230. Audi Insurance is sold, underwritten and administered by Allianz Insurance plc registered in England number 84638. Registered office 57 Ladymead, Guildford, Surrey GU1 1DB. Volkswagen Financial Services (UK) Limited and Allianz Insurance plc are authorised and regulated by the Financial Services Authority. Volkswagen Financial Services (UK) Limited and Allianz Insurance plc are not part of the same corporate group.

Audi UK

Customer Services
Selectapost 29
Sheffield
S97 3FG
0800 699888
audi.co.uk

Specifications and prices subject
to change without notice.

© Audi (UK)

Printed in the UK
Edition 3.0 05/10
2011 Model Year

Images are for illustrative purposes only.



Mixed Sources
Product group from well-managed
forests and other controlled sources

Cert no. TT-COC-002327
www.fsc.org
© 1996 Forest Stewardship Council