



## The Audi A6

Pricing and Specification Guide  
Valid from October 2010



# Personalising your Audi A6

This guide has been designed to help you tailor and price your Audi A6 quickly and logically. At the back, you will also find information on CO<sub>2</sub> emissions-based vehicle excise duty and the other services offered by Audi, including Finance and Insurance. Alternatively, you can go to [audi.co.uk](http://audi.co.uk) and configure your Audi A6 online.

## The Audi A6

Efficiency	8
Engines	10
Transmissions	11
quattro®	12

## Model details and prices

Standard model equipment	14
SE model equipment	16
S line model equipment	16
S line Special Edition model equipment	17
S6 model equipment	18
Model prices	20

<b>Audi exclusive</b>	24
-----------------------	----

## Colour and upholstery

Paint	28
Upholstery	30
Colour and trim guide	34
Inlays	40

## Options

Wheels, tyres and suspension	42
Packages	44
Audio and communication	46
Seats	48
Safety and security	50
Interior equipment	52
Exterior equipment	54
Steering wheels	56
Controls packs	57
Service Plan and warranty	58
Merchandise	59
Accessories	60

## Technical details

Technical data	61
Dimensions	65
Additional information	69
Pricing information	71





## Vorsprung durch Technik

Three words that express the very essence of Audi. Vorsprung durch Technik isn't a slogan. It's our way of seeing the world. It is the driving force behind our history of innovation that continues into the 21st century. Indeed, many technologies that Audi pioneered remain in our cars today. Some are milestones

in the history of the motorcar. From our beginnings in 1899, to the Auto Union team's Grand Prix successes in the 1930s and our more recent wins at Le Mans, we have always been at the forefront of the motor industry.

Vorsprung durch Technik makes us who we are. To see more of its influence, just read on.

## The Audi A6 – luxury refined

We haven't made the fuel tank bigger, we've just made our engines more fuel efficient. On the Audi A6 2.0 TDIe, for instance, you'll get up to 107 more miles each time you fill up. And across the whole Audi A6 diesel engine range, you'll get between 48 and 127 more miles. So one place you won't be going with all those extra miles is the petrol station.





## Efficiency

At Audi, doing less is something we're trying to do more of. We're working to use less fuel, release less CO<sub>2</sub> and waste less energy. It's why we've incorporated a number of more efficient technologies into the Audi A6.

### Aerodynamics

A car's shape can have a big impact on its efficiency. It's why we've worked to make the Audi A6 as aerodynamic as possible, including technology such as optional adaptive air suspension that responds to changes in speed. It means that the Audi A6 becomes more aerodynamic at high speeds, while still offering good ground clearance when needed.

### TDI® and FSI®

Inside the engine of the Audi A6 you'll find the same advanced fuel-injection technology that's driven us to win after win at Le Mans. With TDI® and FSI®, fuel is injected directly into the engine's chambers so that combustion is timed right down to the millisecond. As a result, waste is minimised and you get the most from every last drop of fuel.







### **Recuperation**

When a vehicle brakes, the discs convert the kinetic energy into thermal energy, which is wasted as it cannot be used.

With a recuperation system, like the one in the Audi A6, the kinetic energy is converted into useful electrical energy.

The way it works is simple. While the car is coasting or braking, the alternator voltage is raised above the level of the basic electrical system, which enables the alternator to generate electrical energy and store it temporarily in the battery. When the vehicle accelerates, this energy is used to relieve the load on the alternator, resulting in a fuel saving of up to 3%.

## Engines

### Petrol

FSI® direct-injection technology is a unique Audi innovation that was originally developed for the Le Mans 24-hour endurance race to deliver more power and torque, as well as enhanced fuel efficiency. Precisely the right amount of fuel and air are injected into the combustion chambers, enabling the engine to 'breathe' more easily. It results in reduced heat loss and increased output, with around a 15% reduction in fuel consumption and significantly lower exhaust emissions. We've also developed TFSI®, with either turbocharging or supercharging, which combines FSI® technology with forced induction – giving cars an extra injection of power.

### Diesel

We introduced TDI® to the roads in 1989, marking a departure from the noisy, fuel-thirsty diesel engines of the past. And since then, we've continually refined it, recently developing common-rail technology. Under this system, a series of piezo injectors use electrical charge to precisely control the amount of fuel injected into the engine. As well as reducing noise, this allows combustion to happen at a lower temperature, with less oxygen, which lowers emissions.





## Transmissions

### **multitronic®**

Translating a driver's preferences and intentions into road performance, the multitronic® transmission system entertains no compromises – whether in terms of dynamism, convenience or economy. multitronic® automatic transmission is available on models without quattro® permanent all-wheel-drive.

A continuously variable transmission, multitronic® can transmit up to 400Nm of torque and permits an exceptionally wide range of gear ratios. The result is smooth, powerful acceleration and a high level of driving comfort. And thanks to its lightweight design and a number of advanced electronic control systems that monitor gradient, road conditions and the way the driver is using the accelerator pedal, multitronic® also plays an instrumental role in reducing fuel consumption.

### **tiptronic**

The 6-speed tiptronic transmission system is a form of automatic transmission available on Audi models with quattro® permanent all-wheel-drive. The technology converts high-torque engine power into both sporty performance and operating convenience, with crisp, fast gear changes, reduced weight and an optimised gear-shift strategy. More spontaneous gear changes are a particular benefit, especially when down-shifting. Both in the 'D' (Drive) and 'S' (Sport) programme, the advanced electronics used in tiptronic respond efficiently to every driver input, helping to prevent unwanted upshifts when cornering.

## quattro®

It's the technology that has given Audi the edge on the racetrack ever since it was first introduced 30 years ago – a technology that delivers ultimate control whilst enhancing the sporty characteristics which make the Audi A6 so thrilling to drive. It's called quattro® permanent all-wheel-drive. The principle is simple: in the same way that four brakes ensure better deceleration, four permanently-driven wheels deliver better acceleration and road-holding, pushing or pulling the car as needed, for a driving experience that's both dynamic and safe.

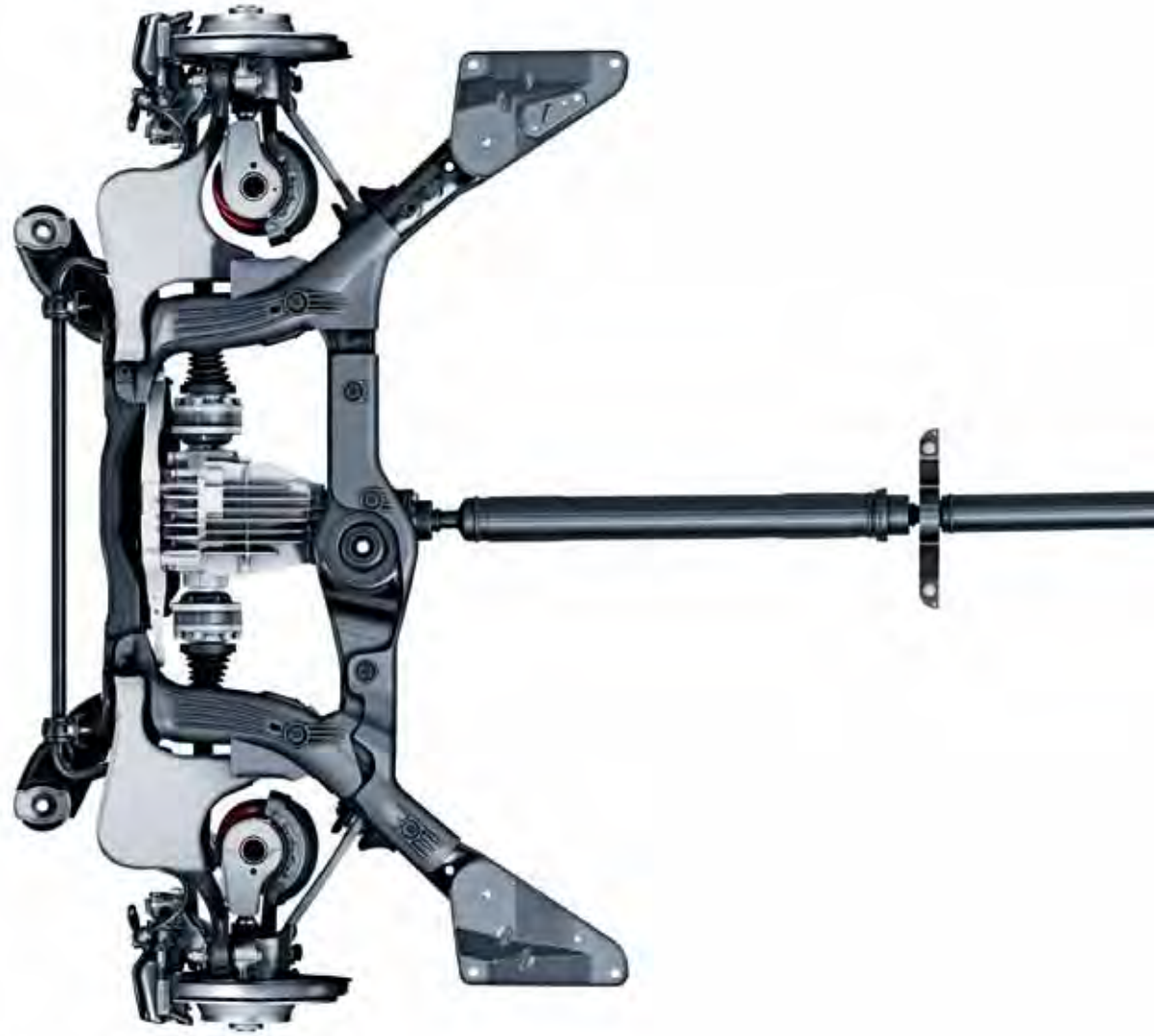

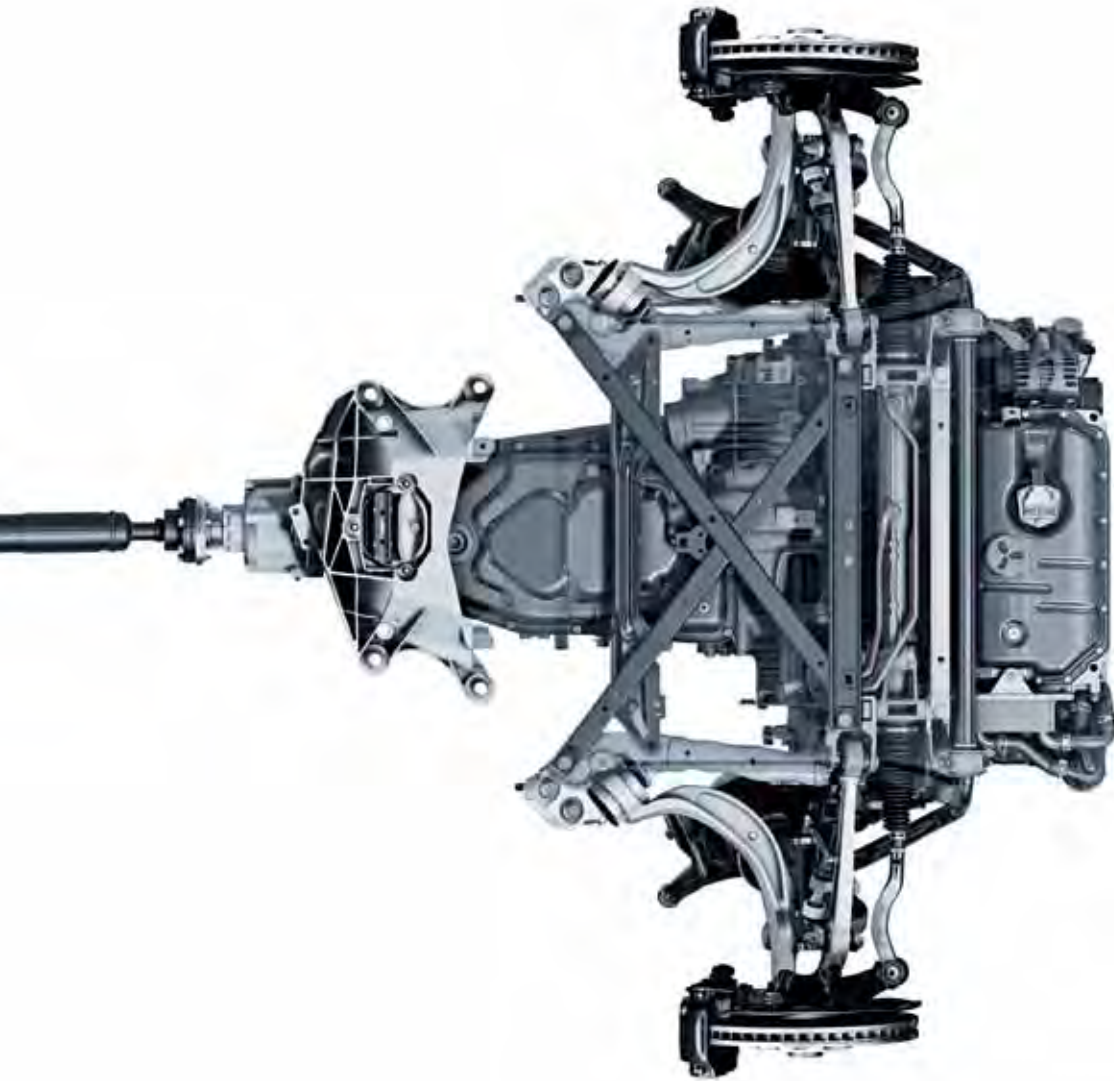

In the Audi A6, asymmetric dynamic torque distribution continuously distributes drive power between the front and rear axles, depending on weather conditions, road surface and gradient. This leads to greater flexibility and an enhanced, sportier drive.

# Standard model equipment

All A6 models have the following items of standard equipment

## Wheels, tyres and suspension

17" x 8J 'Structure' design alloy wheels with 225/50 R17 tyres

Four-link front suspension

Spare wheel – full-size alloy\*

Sports suspension, 20mm lower (2.0 TDiE models only)

## Audio and communication

MMI Radio Plus, including

– FM/AM radio

– 10 speakers

– Single CD player

– DSP sound system

– 2x SD memory card readers

## Safety and security

Anti-lock Braking System (ABS) with EBD

Anti-Slip Regulation (ASR) traction control

Audi backguard head restraints for front seats (adjustable)

Brake light – third brake light in rear window

Brake system: disc brakes at front and rear, ventilated at front

Central locking with radio remote-control

Driver and front passenger two-stage airbags with front passenger airbag deactivation

Dynamic suspension system

Electric child locks for rear doors and windows

Electromechanical parking brake

Electronic Differential Lock (EDL) traction control

Exit lights and active reflectors on all doors

Front fog-light

ISOFIX child-seat mounting (front-left and outer-rear seats)

LED rear lights

Light and rain sensors including coming/leaving home function

Rear fog-light

Servotronic steering – power steering with speed-dependent control

Side airbags for driver and front passenger

Sideguard head airbag system to protect front and outer rear passengers in a side collision

Side-impact protection in all doors

Thatcham Category 1 alarm and immobiliser

Warning triangle

## Seats

3-point seat belts for all seats with front belt-force limiters

Split-folding rear seats

Meridian cloth upholstery

## Interior equipment

12V power socket in luggage compartment (Avant models only)

12V power socket in rear centre console

4-spoke leather multi-function steering wheel (adjustable for reach and rake)

Aluminium fascia and door trim inlays

Ashtrays, illuminated, at the front of the centre console and in the rear doors



17" x 8J 'Structure' design alloy wheels



Dual-zone electronic climate control



Split-folding rear seats

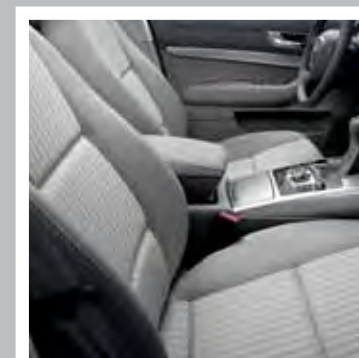

Meridian cloth upholstery

Centre armrests, front and rear, with storage compartment

Coat hooks with cushioned action, two recessed in roof area

Compartment for glasses in front roof module

Cruise control

Cup holder within the centre console storage compartment and a second cup holder beneath the front centre armrest

Driver's Information System (DIS)

Dual-zone electronic climate control

Electric front and rear windows

Floor mats in front and rear

Heated rear window

Heat-insulating glass

Illuminated vanity mirrors

Roof rails in aluminium (Avant models only)

Load area comprising rail system, lashing points and folding load-area floor (Avant models only)

Luggage compartment cover (Avant models only)

Reading lights – two at front and two at rear

Scuff plates with metal inlays

Tool kit in luggage compartment

#### Exterior equipment

Body-coloured door mirrors, handles and bumpers

Electrically adjustable and heated door mirrors

Halogen headlights with manual range adjustment

Rear window wash/wipe (Avant models only)

Windscreen-washer jets, heated



4-spoke leather multi-function steering wheel



Driver/front passenger two-stage airbags with front passenger airbag deactivation

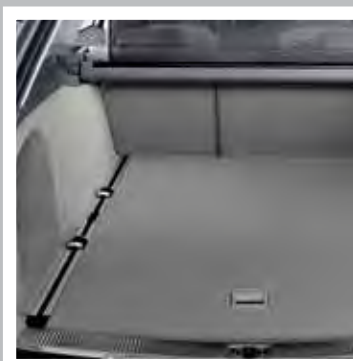

A6 Avant lashing points and rail system

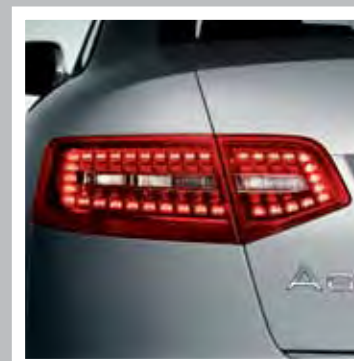

LED rear lights

## SE model equipment

### In addition to Standard model equipment

#### Audio and communication

Mobile telephone preparation – Low (see page 46 for details)

Technology package – Low\*, including:

- Satellite Navigation system – DVD-based (see page 44 for details)
- 6-disc CD changer
- Colour Driver's Information System (DIS)

#### Safety and security

Auto-dimming rear-view mirror

#### Seats

Milano leather upholstery

#### Basic RRP

£1,108.33

#### Total RRP inc VAT

£1,300.00



Milano leather upholstery



Mobile telephone preparation – Low

## S line model equipment

### In addition to SE model equipment

#### Wheels, tyres and suspension

18" x 8J '5-spoke' design alloy wheels with 245/40 R18 Y tyres

Sports suspension (S line suspension available at no extra cost\*\*)

#### Seats

Front Sports seats with S line logo, including electrically adjustable lumbar support for both front seats

#### Interior equipment

Black cloth headlining

Gear knob in perforated leather

3-spoke leather multi-function steering wheel – with S line logo (with shift paddles on automatic models)

Matt-brushed aluminium fascia and door trims

#### Exterior equipment

Headlight washers

S line body styling (front bumper and rear diffuser in Sports design)

Xenon Plus headlights with LED daytime-running lights and kerb lights

#### Basic RRP

£1,062.50

#### Total RRP inc VAT

£1,275.00

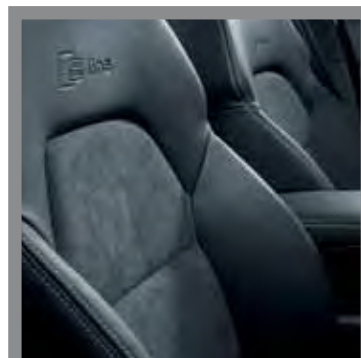

Front Sports seats with S line logo



3-spoke leather multi-function steering wheel – with S line logo

\*Subject to availability.

RRP – Recommended Retail Price. All prices are subject to VAT at 20% reflecting the VAT rate most likely to be in force at the time of delivery. The VAT rate may change if the vehicle is delivered before 4 January 2011 or if the VAT rate subsequently changes.

\*\*Not available on 2.0 TDI 136PS models.

RRP – Recommended Retail Price. All prices are subject to VAT at 20% reflecting the VAT rate most likely to be in force at the time of delivery. The VAT rate may change if the vehicle is delivered before 4 January 2011 or if the VAT rate subsequently changes.



# S line Special Edition model equipment

In addition to S line model equipment

<p><b>Basic RRP</b> £212.50</p> <hr/> <p><b>Total RRP inc VAT</b> £255.00*</p>
--

The Audi A6 is a rather special car – so think of this as extra special. The S line Special Edition package builds on S line specification, adding equipment including parking aids, larger alloy wheels and heated seats. Extras that combine to create the ultimate in refinement and luxury.

### Wheels, tyres and suspension

19" x 8.5J '7-double-spoke' design alloy wheels with 255/35 R19 tyres

### Exterior equipment

Acoustic parking system – rear  
Metallic paint

### Seats

Heated front seats

### Interior equipment

Light package



RRP – Recommended Retail Price. All prices are subject to VAT at 20% reflecting the VAT rate most likely to be in force at the time of delivery. The VAT rate may change if the vehicle is delivered before 4 January 2011 or if the VAT rate subsequently changes.  
\*Valid for new vehicle orders placed up to and including 31 March 2011. Offers subject to availability



## In addition to A6 Standard model equipment

Whether you opt for the Saloon or Avant, this model features a very potent engine – the 5.2 V10 FSI®. The first ever V10 from Audi, this 435PS powerhouse has been developed with technical input from Lamborghini. The performance speaks for itself – 0-62mph in the Saloon takes just 5.2 seconds, with a mere tenth-of-a-second's difference in the Avant. Channelling all that power and maximising both handling and agility is our advanced quattro® system, modified aluminium Sports suspension and 19" alloy wheels.

### Wheels, tyres and suspension

19" x 9J 5-arm 'S' design alloy wheels with 265/35 R19 tyres  
Full-size spare wheel

### Audio and communication

6-disc CD changer  
Bluetooth mobile phone preparation – High  
Satellite Navigation system – HDD-based  
MMI 3G Multi Media Interface with 7" high resolution screen

### Seats

Leather/Alcantara 'S' Sports seats – electrically adjustable with electric lumbar support  
Split-folding rear seats

### Interior equipment

Auto-dimming rear-view mirror  
Carbon Atlas inlays

Coloured instrument inserts with white needles  
Colour Driver's Information System (DIS)  
Light package  
Leather-trimmed 3-spoke multi-function steering wheel with 'S6' logo, contrasting stitching and gear-change shift paddles in aluminium look  
'S' gear knob in leather and aluminium  
Storage pack (for details see page 52)

### Exterior equipment

80-litre fuel tank  
Aluminium-look wing mirrors  
Black-painted brake callipers featuring the S6 logo at front (15" brake discs at front, 13" at rear)  
Dual-branch oval exhaust system (4 tailpipes)  
LED daytime-running lights integrated in the bumper

'S' grille (Platinum grey): double vertically-oriented chrome struts  
'S' rear spoiler  
'S' specific bumpers  
'S' specific Sports chassis with latest-generation quattro® all-wheel-drive, incorporating a 60/40 rear-biased torque-split  
S6 door-sill trim in aluminium look  
V10 badge on wheel arch  
Xenon Plus headlights including headlight washers



'S' Sports seats in optional Silk Nappa leather

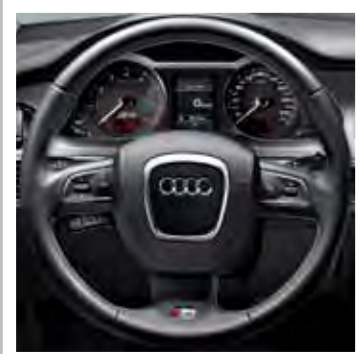

Leather-trimmed 3-spoke multi-function steering wheel with S6 logo

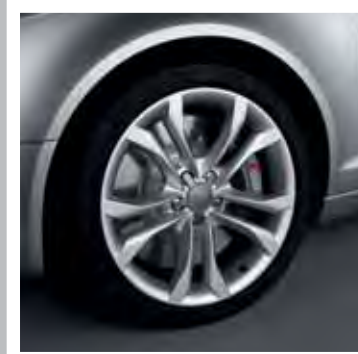

19" x 9J 5-arm 'S' design alloy wheels



LED daytime-running lights integrated in the bumper



'S' Sports seats in optional Silk Nappa leather

## A6 Saloon Standard

Engines	Power	Transmissions	Basic RRP	Total RRP inc VAT	Recommended OTR
2.0 TFSI	170PS	6-speed manual	£22,158.33	£26,590.00	£27,485.00
2.0 TDIe	136PS	6-speed manual	£21,816.67	£26,180.00	£26,935.00
2.0 TDI	170PS	6-speed manual	£22,670.83	£27,205.00	£27,975.00

## A6 Avant Standard

Engines	Power	Transmissions	Basic RRP	Total RRP inc VAT	Recommended OTR
2.0 TFSI	170PS	6-speed manual	£23,495.83	£28,195.00	£29,090.00
2.0 TDIe	136PS	6-speed manual	£23,154.17	£27,785.00	£28,540.00
2.0 TDI	170PS	6-speed manual	£24,008.33	£28,810.00	£29,610.00

**Please note:** The maximum power output figures are quoted in PS (or Pferdestärke, which is the metric equivalent of brake horsepower). To convert to brake horsepower, divide the PS figure by 1.0139.

**Recommended On-The-Road (OTR) retail prices include:** delivery charge, half a tank of fuel, number plates at £590.00 (inc. VAT), Road Fund Licence (which may vary depending on model/transmission – see page 69 for details) and first registration fee at £55.00. Vehicle Excise Duty correct at time of going to print, but this may alter to reflect any change in the applicable VED rate.

RRP – Recommended Retail Price. All prices are subject to VAT at 20% reflecting the VAT rate most likely to be in force at the time of delivery. The VAT rate may change if the vehicle is delivered before 4 January 2011 or if the VAT rate subsequently changes.

## A6 Saloon SE

Engines	Power	Transmissions	Basic RRP	Total RRP inc VAT	Recommended OTR
2.0 TFSI	170PS	6-speed manual	£23,266.67	£27,920.00	£28,815.00
2.8 FSI	220PS	7-speed multitronic	£27,041.67	£32,450.00	£33,520.00
2.8 FSI quattro	220PS	6-speed tiptronic	£28,362.50	£34,035.00	£35,230.00
3.0 TFSI quattro	290PS	6-speed tiptronic	£30,829.17	£36,995.00	£38,190.00
2.0 TDIe	136PS	6-speed manual	£22,925.00	£27,510.00	£28,265.00
2.0 TDI	170PS	6-speed manual	£23,779.17	£28,535.00	£29,305.00
2.7 TDI	190PS	6-speed manual	£26,479.17	£31,775.00	£32,575.00
2.7 TDI quattro	190PS	6-speed tiptronic	£29,033.33	£34,840.00	£35,910.00
3.0 TDI quattro	240PS	6-speed manual	£29,766.67	£35,720.00	£36,665.00

## A6 Avant SE

Engines	Power	Transmissions	Basic RRP	Total RRP inc VAT	Recommended OTR
2.0 TFSI	170PS	6-speed manual	£24,604.17	£29,525.00	£30,420.00
2.8 FSI	220PS	7-speed multitronic	£28,379.17	£34,055.00	£35,125.00
2.8 FSI quattro	220PS	6-speed tiptronic	£29,700.00	£35,640.00	£36,835.00
3.0 TFSI quattro	290PS	6-speed tiptronic	£32,166.67	£38,600.00	£39,795.00
2.0 TDIe	136PS	6-speed manual	£24,262.50	£29,115.00	£29,870.00
2.0 TDI	170PS	6-speed manual	£25,116.67	£30,140.00	£30,940.00
2.7 TDI	190PS	6-speed manual	£27,816.67	£33,380.00	£34,180.00
2.7 TDI quattro	190PS	6-speed tiptronic	£30,370.83	£36,445.00	£37,515.00
3.0 TDI quattro	240PS	6-speed manual	£31,104.17	£37,325.00	£38,270.00

## A6 Saloon S line

Engines	Power	Transmissions	Basic RRP	Total RRP inc VAT	Recommended OTR
2.0 TFSI	170PS	6-speed manual	£24,329.17	£29,195.00	£30,090.00
2.8 FSI	220PS	7-speed multitronic	£28,104.17	£33,725.00	£34,795.00
2.8 FSI quattro	220PS	6-speed tiptronic	£29,425.00	£35,310.00	£36,505.00
3.0 TFSI quattro	290PS	6-speed tiptronic	£31,891.67	£38,270.00	£39,465.00
2.0 TDIe	136PS	6-speed manual	£23,987.50	£28,785.00	£29,540.00
2.0 TDI	170PS	6-speed manual	£24,841.67	£29,810.00	£30,580.00
2.7 TDI	190PS	6-speed manual	£27,541.67	£33,050.00	£33,850.00
2.7 TDI quattro	190PS	6-speed tiptronic	£30,095.83	£36,115.00	£37,185.00
3.0 TDI quattro	240PS	6-speed manual	£30,829.17	£36,995.00	£37,940.00

## A6 Avant S line

Engines	Power	Transmissions	Basic RRP	Total RRP inc VAT	Recommended OTR
2.0 TFSI	170PS	6-speed manual	£25,666.67	£30,800.00	£31,695.00
2.8 FSI	220PS	7-speed multitronic	£29,441.67	£35,330.00	£36,400.00
2.8 FSI quattro	220PS	6-speed tiptronic	£30,762.50	£36,915.00	£38,110.00
3.0 TFSI quattro	290PS	6-speed tiptronic	£33,229.17	£39,875.00	£41,070.00
2.0 TDIe	136PS	6-speed manual	£25,325.00	£30,390.00	£31,145.00
2.0 TDI	170PS	6-speed manual	£26,179.17	£31,415.00	£32,215.00
2.7 TDI	190PS	6-speed manual	£28,879.17	£34,655.00	£35,455.00
2.7 TDI quattro	190PS	6-speed tiptronic	£31,433.33	£37,720.00	£38,790.00
3.0 TDI quattro	240PS	6-speed manual	£32,166.67	£38,600.00	£39,545.00

## A6 Saloon S line Special Edition

Engines	Power	Transmissions	Basic RRP	Total RRP inc VAT	Recommended OTR
2.0 TFSI	170PS	6-speed manual	£24,541.67	£29,450.00	£30,345.00
2.8 FSI	220PS	7-speed multitronic	£28,316.67	£33,980.00	£35,050.00
2.8 FSI quattro	220PS	6-speed tiptronic	£29,637.50	£35,565.00	£36,760.00
3.0 TFSI quattro	290PS	6-speed tiptronic	£32,104.17	£38,525.00	£39,720.00
2.0 TDI	170PS	6-speed manual	£25,054.17	£30,065.00	£30,835.00
2.7 TDI	190PS	6-speed manual	£27,754.17	£33,305.00	£34,105.00
2.7 TDI quattro	190PS	6-speed tiptronic	£30,308.33	£36,370.00	£37,440.00
3.0 TDI quattro	240PS	6-speed manual	£31,041.67	£37,250.00	£38,195.00

## A6 Avant S line Special Edition

Engines	Power	Transmissions	Basic RRP	Total RRP inc VAT	Recommended OTR
2.0 TFSI	170PS	6-speed manual	£25,879.17	£31,055.00	£31,950.00
2.8 FSI	220PS	7-speed multitronic	£29,654.17	£35,585.00	£36,655.00
2.8 FSI quattro	220PS	6-speed tiptronic	£30,975.00	£37,170.00	£38,365.00
3.0 TFSI quattro	290PS	6-speed tiptronic	£33,441.67	£40,130.00	£41,325.00
2.0 TDI	170PS	6-speed manual	£26,391.67	£31,670.00	£32,470.00
2.7 TDI	190PS	6-speed manual	£29,091.67	£34,910.00	£35,710.00
2.7 TDI quattro	190PS	6-speed tiptronic	£31,645.83	£37,975.00	£39,045.00
3.0 TDI quattro	240PS	6-speed manual	£32,379.17	£38,855.00	£39,800.00

**Please note:** The maximum power output figures are quoted in PS (or Pferdestärke, which is the metric equivalent of brake horsepower). To convert to brake horsepower, divide the PS figure by 1.0139.

**Recommended On-The-Road (OTR) retail prices include:** delivery charge, half a tank of fuel, number plates at £590.00 (inc. VAT), Road Fund Licence (which may vary depending on model/transmission – see page 69 for details) and first registration fee at £55.00. Vehicle Excise Duty correct at time of going to print, but this may alter to reflect any change in the applicable VED rate.

RRP – Recommended Retail Price. All prices are subject to VAT at 20% reflecting the VAT rate most likely to be in force at the time of delivery. The VAT rate may change if the vehicle is delivered before 4 January 2011 or if the VAT rate subsequently changes.



## S6 quattro Saloon

Engines	Power	Transmission	Basic RRP	Total RRP inc VAT	Recommended OTR
S6 quattro	435PS	6-speed tiptronic	£48,912.50	£58,695.00	£60,290.00

## S6 quattro Avant

Engines	Power	Transmission	Basic RRP	Total RRP inc VAT	Recommended OTR
S6 quattro	435PS	6-speed tiptronic	£50,250.00	£60,300.00	£61,895.00

**Please note:** The maximum power output figures are quoted in PS (or Pferdestärke, which is the metric equivalent of brake horsepower). To convert to brake horsepower, divide the PS figure by 1.0139.

**Recommended On-The-Road (OTR) retail prices include:** delivery charge, half a tank of fuel, number plates at £590.00 (inc. VAT), Road Fund Licence (which may vary depending on model/transmission – see page 69 for details) and first registration fee at £55.00. Vehicle Excise Duty correct at time of going to print, but this may alter to reflect any change in the applicable VED rate.

RRP – Recommended Retail Price. All prices are subject to VAT at 20% reflecting the VAT rate most likely to be in force at the time of delivery. The VAT rate may change if the vehicle is delivered before 4 January 2011 or if the VAT rate subsequently changes.

## Transmissions

	7-speed multitronic transmission	6-speed tiptronic transmission
2.0 TFSI	●	–
2.8 FSI	S	–
2.8 FSI quattro	–	S
3.0 TFSI quattro	–	S
S6 quattro	–	S
2.0 TDi*	●	–
2.0 TDI 170PS	●	–
2.7 TDI	●	–
2.7 TDI quattro	–	S
3.0 TDI quattro	–	●
<b>Basic RRP</b>	<b>£1,233.33</b>	<b>£1,191.67</b>
<b>Total RRP inc VAT</b>	<b>£1,480.00</b>	<b>£1,430.00</b>

– = Not available

● = Available

S = Standard

\*Please note that due to higher CO<sub>2</sub> emissions, the 2.0 TDI multitronic® is not an 'e' model.



## Audi exclusive





## Audi exclusive

Every Audi is intrinsically exclusive. It's the breathtaking design, the exceptional engineering, the Vorsprung durch Technik. But for that special touch you can specify your new A6 with options from Audi exclusive. Whether you want a unique, custom-mixed paint colour or seats in a combination of complementary shades, Audi exclusive will enable you to drive the car you've always imagined.

Both the exclusive and standard options can be found on the following pages.



## Audi exclusive line



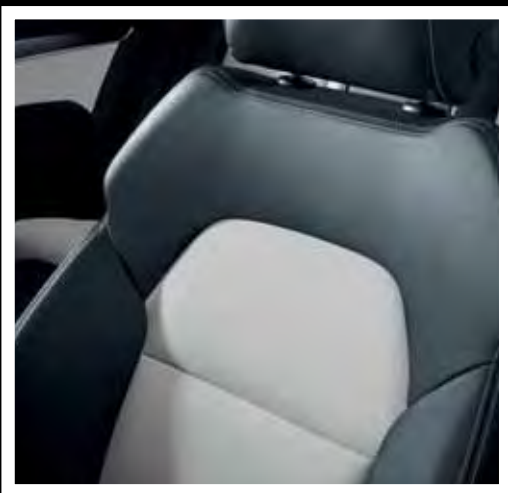

# Paint

You can select one of the standard colours shown opposite or, for a different look, choose from a range of optional finishes.

## Standard colours



Ibis white – T9

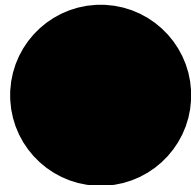

Brilliant black – A2

## Optional colours

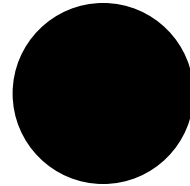

Phantom black, pearl effect – L8

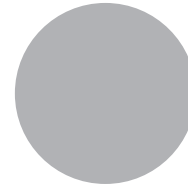

Ice silver, metallic – P5

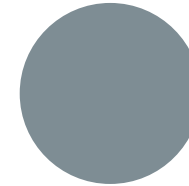

Quartz grey, metallic – Q4

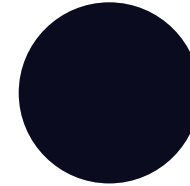

Oyster grey, metallic\* – X1

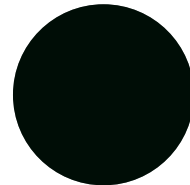

Deep green, pearl effect – 3W

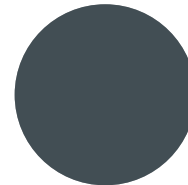

Condor grey, metallic – 5Q

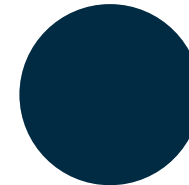

Polar blue, metallic\* – 6A

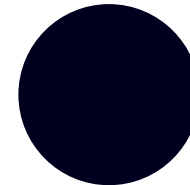

Night blue, pearl effect – 7X

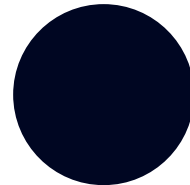

Aventurine blue, pearl effect – 7Y

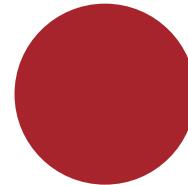

Garnet red, pearl effect\* – 9C

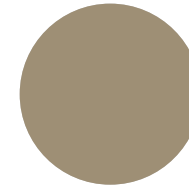

Dakar beige, metallic\* – 9X

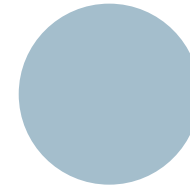

Monza silver, metallic\*\* – U7

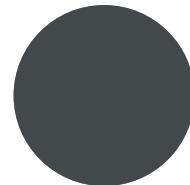

Daytona grey, pearl effect\*\* – 6Y

Options are subject to availability and may extend delivery.

\*Not available on S6 models.

\*\*Only available on S line models.

All the colour swatches on this page are matched as accurately as possible to the actual paint colours used. However, due to print processes, Audi UK cannot guarantee that colours shown are 100% accurate.

Visit your local Audi Centre for a more accurate colour swatch.

RRP – Recommended Retail Price.

All prices are subject to VAT at 20% reflecting the VAT rate most likely to be in force at the time of delivery. The VAT rate may change if the vehicle is delivered before 4 January 2011 or if the VAT rate subsequently changes.

### Optional colours

**Basic RRP**  
£595.83

**Total RRP inc VAT**  
£715.00

No charge on S line Special Edition models.

**S6 colours**

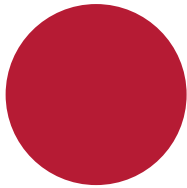

Brilliant red - CB

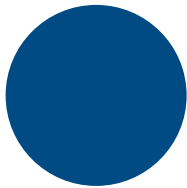

Sprint blue, pearl effect - 5N

# Paint

## Audi exclusive

Everyone has a favourite colour. No matter what yours is, Audi exclusive provides a range of unique colours that have been designed to set your car apart. Choose from the swatches here, or specify any other paint colour in the Audi range - whether it's Jet blue from the Audi R8 or Alpine white from the original Audi quattro®. The choice is yours.

## Customised

If you have a particular colour in mind, we'll mix the exact metallic or pearl-effect shade you want.\*

\*Custom paint is subject to factory approval, and is available for metallic and pearl-effect water-based paints only. Three-colour process colours and two-tone schemes are not available.

\*\*Visit your local Audi Centre for colour samples

All the colour swatches on this page are matched as accurately as possible to the actual paint colours used. However, due to print processes, Audi UK cannot guarantee that colours shown are 100% accurate.

Visit your local Audi Centre for a more accurate colour swatch.

RRP - Recommended Retail Price.

All prices are subject to VAT at 20% reflecting the VAT rate most likely to be in force at the time of delivery. The VAT rate may change if the vehicle is delivered before 4 January 2011 or if the VAT rate subsequently changes.

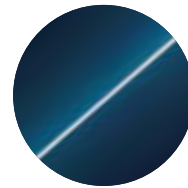

Palace blue, pearl effect

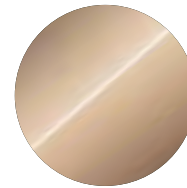

Sand beige, pearl effect

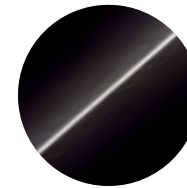

Saddle brown, pearl effect

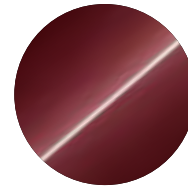

Classic red, pearl effect

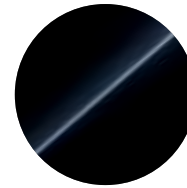

Mamba black, metallic

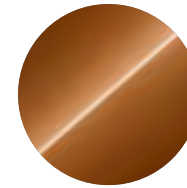

Ipanema brown, metallic



Any colour in the Audi range



100 Audi exclusive colours to choose from\*\*

<p><b>Audi exclusive</b></p> <p><b>Basic RRP</b> £1,445.83</p> <hr/> <p><b>Total RRP inc VAT</b> £1,735.00</p>
--



Customised paint

<p><b>Customised</b></p> <p><b>Basic RRP</b> £2,041.67</p> <hr/> <p><b>Total RRP inc VAT</b> £2,450.00</p>
--

# Upholstery

## Standard seats









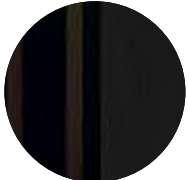
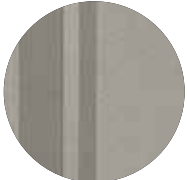

Choose your favourite upholstery from the swatches shown opposite to give your car's interior the look and feel you want.

Options are subject to availability and may extend delivery.

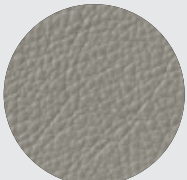
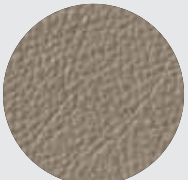
- = Not available
- = Available
- S = Standard

RRP - Recommended Retail Price.

All prices are subject to VAT at 20% reflecting the VAT rate most likely to be in force at the time of delivery. The VAT rate may change if the vehicle is delivered before 4 January 2011 or if the VAT rate subsequently changes.

						Standard	SE	S line	S line Special Edition	S6 quattro	Basic RRP	Total RRP inc VAT
Meridian cloth						S	-	-	-	-	No charge	No charge
	Black - GD	Light grey - GV										
Arkana cloth						•	-	-	-	-	£104.17	£125.00
	Black - GD	Light grey - GV	Cardamom beige - GX									
Milano leather						•	S	-	-	-	£1,275.00	£1,530.00
	Black - GD	Light grey - GV	Cardamom beige - GX	Amaretto brown - LR								
Valcona leather						•	-	-	-	-	£1,533.33	£1,840.00
	Black - GD	Light grey - GV	Cardamom beige - GX	Linen beige - GS								
						-	•	-	-	-	£258.33	£310.00
	Amaretto brown - LR											

# Upholstery

## Sports seats









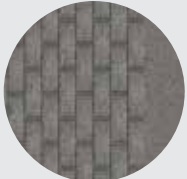

Front Sports seats including 4-way electric lumbar support and manual height adjustment.

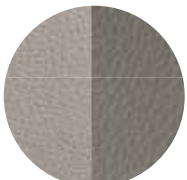
Options are subject to availability and may extend delivery.

- = Not available  
• = Available  
S = Standard

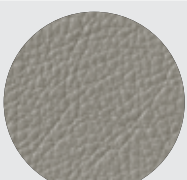
RRP – Recommended Retail Price.





All prices are subject to VAT at 20% reflecting the VAT rate most likely to be in force at the time of delivery. The VAT rate may change if the vehicle is delivered before 4 January 2011 or if the VAT rate subsequently changes.

						Standard	SE	S line	S line Special Edition	S6 quattro	Basic RRP	Total RRP inc VAT
Mistral cloth		Black – GD		Light grey – GV		•	-	-	-	-	£404.17	£485.00
		Black – GD		Light grey/Silver – GW		•	-	-	-	-	£1,937.50	£2,325.00
Valcona leather		Cardamom beige/Linen beige – GZ				-	•	-	-	-	£662.50	£795.00
		Black – GD		Light grey – GV		•	-	-	-	-	£1,679.17	£2,015.00
Milano leather		Black – GD		Light grey – GV		-	•	-	-	-	£404.17	£485.00
		Black – GD		Light grey – GV		•	-	-	-	-	£1,341.67	1,610.00
Leather/Alcantara		Black – GD		Light grey – GV		-	•	-	-	-	£66.67	£80.00

# Upholstery

## S line seats

Embossed with S line logo.

		Standard	SE	S line	S line Special Edition	S6 quattro	Basic RRP	Total RRP inc VAT
Milano leather	 Black - QE	-	-	S	S	-	No charge	No charge
Sprint cloth/Leather	 Black - QE/QF	-	-	•	•	-	No charge	No charge
Valcona leather	 Black - QE	-	-	•	•	-	£254.17	£305.00
Leather/Alcantara (perforated Alcantara)	 Black - QE/QF	-	-	•	•	-	No charge	No charge

Options are subject to availability and may extend delivery.

- = Not available
- = Available
- S = Standard

RRP – Recommended Retail Price.

All prices are subject to VAT at 20% reflecting the VAT rate most likely to be in force at the time of delivery. The VAT rate may change if the vehicle is delivered before 4 January 2011 or if the VAT rate subsequently changes.



# Upholstery

## S6 quattro® seats

Embossed with S6 quattro® logo.

Silk Nappa leather /Alcantara



Black - SC



Pearl silver - SE

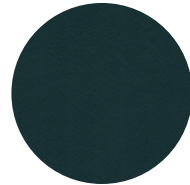

Black - SC



Pearl silver - SE

	Standard	SE	S line	S line Special Edition	S6 quattro	Basic RRP	Total RRP inc VAT
Alcantara	-	-	-	-	S	No charge	No charge
Silk Nappa leather	-	-	-	-	●	£341.67	£410.00

Options are subject to availability and may extend delivery.

- = Not available
- = Available
- S = Standard

RRP – Recommended Retail Price.

All prices are subject to VAT at 20% reflecting the VAT rate most likely to be in force at the time of delivery. The VAT rate may change if the vehicle is delivered before 4 January 2011 or if the VAT rate subsequently changes.

# Colour and trim guide

## Interior trim colours

### Standard seats

To help you choose the right interior for your new Audi A6, please use this guide, showing the carpet, dashboard and headlining colours that have been matched to your chosen upholstery.

Order Code	Upholstery	Carpet	Dashboard (upper/lower)	Headlining	Meridian cloth (N2C)	Arkana cloth (N3A)	Valcona leather (N5D)	Milano leather (N5W)
GD	Black	Black	Black	Silver	●	●	●	●
GS	Linen beige	Black	Black	Linen beige	—	—	●	—
GT	Linen beige/Black	Black	Black	Linen beige	—	—	—	—
LR	Amaretto brown	Black	Black	Amaretto brown	—	—	●	●
GU	Amaretto brown/Black	Black	Black	Amaretto brown	—	—	—	—
GV	Light grey	Light grey	Graphite grey/Light grey	Silver	●	●	●	●
GW	Silver/Light grey	Light grey	Graphite grey/Light grey	Silver	—	—	—	—
GX	Cardamom beige	Cardamom beige	Taupe beige/Cardamom beige	Linen beige	—	●	●	●
GZ	Linen beige/Cardamom beige	Cardamom beige	Taupe beige/Cardamom beige	Linen beige	—	—	—	—

### Sports seats

Order Code	Upholstery	Carpet	Dashboard (upper/lower)	Headlining	Mistral cloth (NOD)	Valcona leather (N5D)	Alcantara/leather (N7U)	Milano leather (N5W)
GD	Black	Black	Black	Silver	●	●	●	●
GS	Linen beige	Black	Black	Linen beige	—	—	—	—
GT	Linen beige/Black	Black	Black	Linen beige	—	●	—	—
LR	Amaretto brown	Black	Black	Amaretto brown	—	—	—	—
GU	Amaretto brown/Black	Black	Black	Amaretto brown	—	●	—	—
GV	Light grey	Light grey	Graphite grey/Light grey	Silver	●	—	●	●
GW	Silver/Light grey	Light grey	Graphite grey/Light grey	Silver	—	●	—	—
GX	Cardamom beige	Cardamom beige	Taupe beige/Cardamom beige	Linen beige	—	—	—	—
GZ	Linen beige/Cardamom beige	Cardamom beige	Taupe beige/Cardamom beige	Linen beige	—	●	—	—

Options are subject to availability and may extend delivery.

— = Not available  
 ● = Available  
 S = Standard

# Colour and trim guide

## Interior trim colours

S line and S line  
Special Edition seats

Order Code	Upholstery	Carpet	Dashboard (upper/lower)	Headlining	Sprint cloth/ leather (N7V)	Milano leather (N1H)	Valcona leather (N1V)	Leather/Alcantara (perforated Alcantara) (N7K)
QE	Black	Black	Black	Black	●	●	●	●
QF	Black/Silver stitching	Black	Black	Black	●	—	—	●

S6 seats

Order Code	Upholstery	Carpet	Dashboard (upper/lower)	Headlining	Leather/Alcantara (N7N)	Silk Nappa leather (N1U)
SC	Black	Black	Black	Silver	●	●
SE	Pearl silver	Black	Black	Silver	●	●

Options are subject to availability and may extend delivery.

— = Not available  
● = Available  
S = Standard



# Upholstery

## Audi exclusive

With Audi exclusive, you can specify your seats in Valcona, Fine Nappa leather or a leather/Alcantara combination, in an array of different colours shown to the right.

Select just one all-over shade for each seat, or customise each panel in two or more complementary colours from the distinctive Audi exclusive palette. You can even choose the colour of the decorative stitching – to match or contrast with your chosen upholstery – from this varied collection. Whatever combination you decide upon, we think you'll be extremely comfortable with the result.

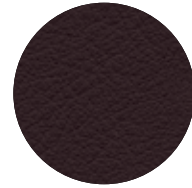

Chestnut brown

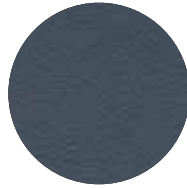

Jet grey

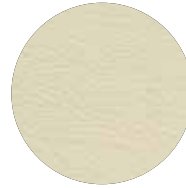

Alabaster white

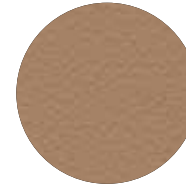

Sand beige

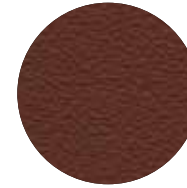

Saddle brown

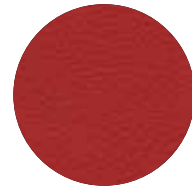

Crimson red



Magnolia white



Havanna brown

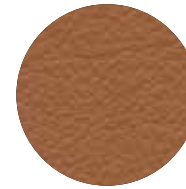

Cognac brown

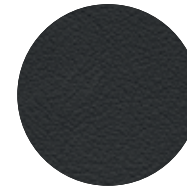

Night blue

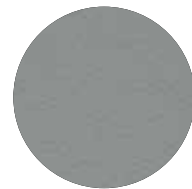

Cloudy grey

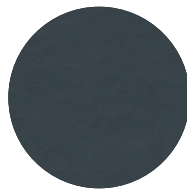

Smoky blue

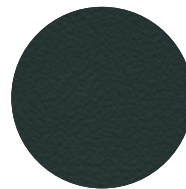

Iceland green

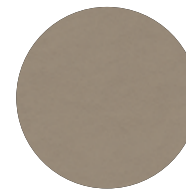

Powder beige

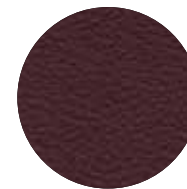

Classic red

### Also available:

**Alcantara colours:** available in all the Audi exclusive colours shown, except for Crimson red, Jet grey and Sand beige. Alcantara equivalents are Chilli red, Amethyst grey, and Sesame beige respectively.

Please consult your Audi Centre for examples of Alcantara and carpet colours.

# Upholstery

## Audi exclusive

Order Code		Standard	SE	S line	S line Special Edition	S6 quattro	Basic RRP	Total RRP inc VAT
PYA S3G	<b>Audi exclusive leather package 1 in Fine Nappa leather.</b> Includes leather-covered seat upholstery, door trim inserts and front centre armrest. Backrest covers and seat add-on parts come in the interior trim colour*	●	–	–	–	–	£3,575.00	£4,290.00
		–	●	–	–	–	£2,300.00	£2,760.00
PYB S3G	<b>Audi exclusive leather package 1 in Valcona leather.</b> Includes leather-covered seat upholstery, door trim inserts and front centre armrest. Backrest covers and seat add-on parts come in the interior trim colour*	●	–	–	–	–	£4,083.33	£4,900.00
		–	●	●	●	–	£2,808.33	£3,370.00
		–	–	–	–	●	£2,295.83	£2,755.00
PYC S3G	<b>Audi exclusive leather package 1 in Fine Nappa leather/Alcantara.</b> Includes leather-covered front and back seat-side trims, head restraints and front centre armrest, and Alcantara door trim inserts and seat-centre sections. Backrest covers and seat add-on parts come in the interior trim colour – only in combination with Sports seats	●	–	–	–	–	£3,575.00	£4,290.00
		–	●	●	●	–	£2,300.00	£2,760.00
PYC S3G	<b>Audi exclusive leather package 1 in Valcona leather/Alcantara.</b> Includes leather-covered front and back seat-side trims, head restraints, door trim inserts and front centre armrest, and Alcantara seat-centre sections. Backrest covers and seat add-on parts come in the interior trim colour – only in combination with Sports seats	–	–	–	–	●	£2,295.83	£2,755.00
PYD S3G	<b>Audi exclusive leather package 2 in Fine Nappa leather.</b> Includes all the contents of leather package 1 (PYA/S3G) plus: leather-covered seat backrest covers, door armrests and handles and colour coordinated seat-side trims add-on parts	●	–	–	–	–	£6,383.33	£7,660.00
		–	●	–	–	–	£5,108.33	£6,130.00
PYE S3G	<b>Audi exclusive leather package 2 in Valcona leather.</b> Includes all the contents of leather package 1 (PYB/S3G) plus: leather-covered seat backrest covers, door armrests and handles. Seat-side trims and add-on parts are colour coordinated	●	–	–	–	–	£6,808.33	£8,170.00
		–	●	●	●	–	£5,533.33	£6,640.00
		–	–	–	–	●	£4,979.17	£5,975.00
PYF S3G	<b>Audi exclusive leather package 2 in Fine Nappa leather/Alcantara.</b> Includes all the contents of leather package 1 (PYC/S3G) plus: leather-covered seat backrest covers, door armrests and handles. Seat-side trims add-on parts are colour coordinated – only in combination with Sports seats	●	–	–	–	–	£6,383.33	£7,660.00
		–	●	–	–	–	£5,108.33	£6,130.00
PYF S3G	<b>Audi exclusive leather package 2 in Valcona leather/Alcantara.</b> Includes all the contents of leather package 1 (PYC/S3G) plus: leather-covered backrest covers, door armrests and handles. Seat-side trims and add-on parts are colour coordinated – only in combination with Sports seats	–	–	–	–	●	£4,979.17	£5,975.00

Options are subject to availability and may extend delivery.

– = Not available  
● = Available  
S = Standard

\*Leather and stitching colours (where applicable) can be specified in a variety of colours from the Audi exclusive range.

RRP – Recommended Retail Price.

All prices are subject to VAT at 20% reflecting the VAT rate most likely to be in force at the time of delivery. The VAT rate may change if the vehicle is delivered before 4 January 2011 or if the VAT rate subsequently changes.

# Upholstery

## Audi exclusive line

Audi exclusive is ultimately about choice – but if you’d rather leave some of the decisions in the capable hands of our designers, the expert team at quattro GmbH have compiled Audi exclusive line, combining some of the most popular elements of the exclusive range in one, beautifully coordinated package.

Options are subject to availability and may extend delivery.

– = Not available  
 • = Available  
 S = Standard

\*On S line models, S line door sills supersede exclusive line door sills.

\*\*4-spoke steering wheel.

RRP – Recommended Retail Price.

All prices are subject to VAT at 20% reflecting the VAT rate most likely to be in force at the time of delivery. The VAT rate may change if the vehicle is delivered before 4 January 2011 or if the VAT rate subsequently changes.

Order Code		Standard	SE	S line	S line Special Edition	S6 quattro	Basic RRP	Total RRP inc VAT
<b>WQK</b>	<b>Audi exclusive line</b>	•	–	–	–	–	£2,979.17	£3,575.00
		–	•	–	–	–	£1,704.17	£2,045.00
<b>WQI</b>	<b>Audi exclusive line</b>	–	–	•	•	–	£1,020.83	£1,225.00



Silver – QL



Cognac – QX

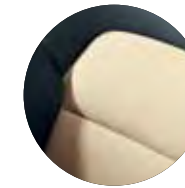

Magnolia white – QQ

### The package includes:

- ▶ Sports seats in two-tone Valcona leather, with black seat-side sections with coloured stitching and coloured seat-centre section in Silver (QL), Cognac (QX) or Magnolia white (QQ)
- ▶ Door-trim inserts in black to match interior trim
- ▶ Black dashboard and carpets
- ▶ Black cloth headlining
- ▶ Audi exclusive door sill trims\*
- ▶ Brushed aluminium inlays
- ▶ Floor mats in black with coloured piping (to match seat-centre section)
- ▶ Leather-covered steering wheel\*\* (multitronic® or tiptronic with shift paddles)
- ▶ Steering wheel rim and gear-lever gaiter with coloured stitching in matching colour to seat-centre section
- ▶ Head restraints with coloured stitching in matching colour to seat-centre section



Sports seats in two-tone Valcona leather, with black seat-side sections with coloured stitching and coloured seat-centre section in Magnolia white – QQ

# Inlays

Inlays are the all-important finishing touch that add flair and interest to your car's interior, available in a variety of textures and finishes.

Order Code		Standard	SE	S line	S line Special Edition	S6 quattro	Basic RRP	Total RRP inc VAT
<b>5TD</b>	<b>Radial aluminium</b>	S	S	-	-	-	No charge	No charge
<b>5TE</b>	<b>Aluminium trigon</b>	●	●	-	-	-	£212.50	£255.00
<b>5TG</b>	<b>Matt-brushed aluminium</b>	-	-	S	S	●	No charge	No charge
<b>5TL</b>	<b>Piano finish, black</b>	-	-	●	●	-	£466.67	£560.00
<b>5TZ</b>	<b>Fine grain birch wood, grey</b>	-	-	●	●	-	£295.83	£355.00
		-	-	-	-	●	No charge	No charge
<b>7TC</b>	<b>Fine grain birch wood, beige</b>	●	●	-	-	-	£295.83	£355.00
<b>5MG</b>	<b>Walnut, brown</b>	●	●	-	-	-	£295.83	£355.00
<b>7TL</b>	<b>Fine grain ash, natural</b>	●	●	-	-	-	£383.33	£460.00

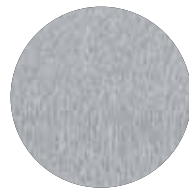

Radial aluminium – **5TD**

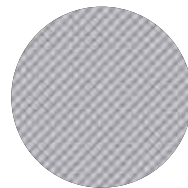

Aluminium trigon – **5TE**



Matt-brushed aluminium – **5TG**

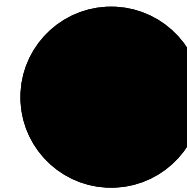

Piano finish, black – **5TL**



Fine grain birch wood, grey – **5TZ**



Fine grain birch wood, beige – **7TC**



Walnut, brown – **5MG**

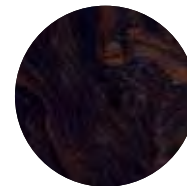

Fine grain ash, natural – **7TL**

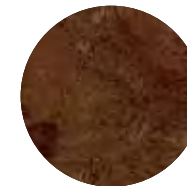

Walnut silk matt, mid brown – **5MS**

Options are subject to availability and may extend delivery.

- = Not available  
● = Available  
S = Standard

RRP – Recommended Retail Price.

All prices are subject to VAT at 20% reflecting the VAT rate most likely to be in force at the time of delivery. The VAT rate may change if the vehicle is delivered before 4 January 2011 or if the VAT rate subsequently changes.



# Inlays

## Audi exclusive

Audi exclusive has sourced a wide range of materials which you can select for your inlays, from Sepia oak to warm Saffron poplar.

Order Code		Standard	SE	S line	S line Special Edition	S6 quattro	Basic RRP	Total RRP inc VAT
YTA S3G	Audi exclusive inlays (cannot be combined with the inlays shown on page 40)	-	•	•	•	•	£979.17	£1,175.00



Fine grain ash, nougat



Fine grain myrtle, nutmeg



Poplar, saffron

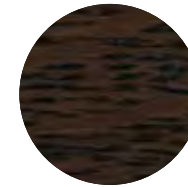

Oak, sepia

Options are subject to availability and may extend delivery.

- = Not available
- = Available
- S = Standard

RRP – Recommended Retail Price.

All prices are subject to VAT at 20% reflecting the VAT rate most likely to be in force at the time of delivery. The VAT rate may change if the vehicle is delivered before 4 January 2011 or if the VAT rate subsequently changes.

## Wheels, tyres and suspension

Choose a set of specially-selected alloy wheels to subtly enhance the way your car looks and drives. There's also adaptive air suspension with four levels for improved comfort.



17" x 8J '7-spoke Star' design alloy wheels\* - PRI



17" x 8J '5-spoke Y' design alloy wheels\* - PRN



18" x 8J '10-spoke Star' design alloy wheels\* - PRK



18" x 8J '5-arm Dynamic' design highly polished alloy wheels - PRL



18" x 8J '5-spoke' design alloy wheels - PQR



18" x 8J '15-spoke' design alloy wheels - PQH



18" x 8J '5-spoke V' design alloy wheels\* - PRC



19" x 8.5J '20-spoke two-piece' design alloy wheels - PQS



19" x 8.5J '5-segment-spoke' design alloy wheels - PQ3

\*Not available on 2.0 TDiE models.

Options are subject to availability and may extend delivery.

- = Not available  
• = Available  
S = Standard

RRP - Recommended Retail Price.

All prices are subject to VAT at 20% reflecting the VAT rate most likely to be in force at the time of delivery. The VAT rate may change if the vehicle is delivered before 4 January 2011 or if the VAT rate subsequently changes.



18" x 8J '10-spoke' design alloy wheels – PQ5



19" x 8.5J '7-double-spoke' design alloy wheels – PQF

Order Code		Standard	SE	S line	S line Special Edition	S6 quattro	Basic RRP	Total RRP inc VAT
PRI	17" x 8J '7-spoke Star' design alloy wheels with 245/45 R17 tyres*	●	●	–	–	–	£295.83	£355.00
PRN	17" x 8J '5-spoke Y' design alloy wheels with 245/45 R17 tyres*	●	●	–	–	–	£295.83	£355.00
PRK	18" x 8J '10-spoke Star' design alloy wheels with 245/40 R18 tyres*	●	●	–	–	–	£595.83	£715.00
PRC	18" x 8J '5-spoke V' design alloy wheels with 245/40 R18 tyres*	●	●	–	–	–	£595.83	£715.00
PQ5	18" x 8J '10-spoke' design alloy wheels with 245/40 R18 tyres	●	●	–	–	–	£937.50	£1,125.00
PRL	18" x 8J '8-arm Dynamic' design highly polished alloy wheels with 245/40 R18 tyres	●	●	–	–	–	£1,150.00	£1,380.00
PQR	18" x 8J '5-spoke' design alloy wheels with 245/50 R18 tyres	●	●	–	–	–	£937.50	£1,125.00
		–	–	S	–	–	No charge	No charge
PQH	18" x 8J '15-spoke' design alloy wheels with 245/40 R18 tyres	●	●	–	–	–	£937.50	£1,125.00
		–	–	●	–	–	No charge	No charge
PQS	19" x 8.5J '20-spoke two-piece' design alloy wheels with 255/35 R19 tyres (not available on any 2.0 TDI 136PS models)	●	●	–	–	–	£1,362.50	£1,635.00
		–	–	●	–	–	£425.00	£510.00
		●	●	–	–	–	£1,362.50	£1,635.00
PQF	19" x 8.5J '7-double-spoke' design alloy wheels with 255/35 R19 tyres*	–	–	●	–	–	£425.00	£510.00
		–	–	–	S	–	No charge	No charge
PQ3	19" x 8.5J '5-segment-spoke' design with tyres 255/35 R19 (quattro GmbH) (not available on 2.0 TDiE model)	●	●	–	–	–	£1,362.50	£1,635.00
		–	–	●	–	–	£425.00	£510.00
		–	–	–	●	–	No charge	No charge
1BK	<b>Adaptive air suspension.</b> Electronically-controlled pneumatic shock-absorbers with four modes (automatic, comfort, dynamic and lift) selected via MMI. Includes automatic level regulation. Only in combination with Adaptive headlights and not available on 2.0 TDiE models	●	●	●	●	–	£1,275.00	£1,530.00
1BE	<b>Sports suspension, lower by 20mm.</b> (Standard on 2.0 TDiE models)	●	●	S	S	–	£254.17	£305.00
PQZ	<b>S line Sports suspension, lower by 10mm.</b> (In addition to Sports suspension)	–	–	●	●	–	No charge	No charge

# Packages

Some items work well together, which is why we've created these special packages. They provide increased convenience and value by combining several of our most popular options.

Options are subject to availability and may extend delivery.

- = Not available
- = Available
- S = Standard

RRP – Recommended Retail Price.

All prices are subject to VAT at 20% reflecting the VAT rate most likely to be in force at the time of delivery. The VAT rate may change if the vehicle is delivered before 4 January 2011 or if the VAT rate subsequently changes.

Order Code	Standard	SE	S line	S line Special Edition	S6 quattro	Basic RRP	Total RRP inc VAT
<b>PNW Technology package – Low. Satellite Navigation system – DVD-based with CD changer</b>	•	S	S	S	–	£1,191.67	£1,430.00

**DVD Satellite Navigation.** DVD-based route-planning and guidance with MMI control logic and 6.5" colour monitor, RDS radio, DVD-player for navigation system, audio or MP3 CDs. Includes European coverage disc

Order Code	Standard	SE	S line	S line Special Edition	S6 quattro	Basic RRP	Total RRP inc VAT
<b>PNG Technology package – High. Satellite Navigation system – HDD-based with MMI 3G and CD changer</b>	–	•	•	•	S	£1,616.67	£1,940.00
						£425.00	£510.00

**HDD Satellite Navigation with MMI 3G.** 3rd generation of MMI including 2 FM tuners, high resolution (800x400) 7" colour TFT display, DVD movie-playing function, colour Driver's Information System, 2 SD card readers and 40GB hard drive – 10GB of which can be used to store up to 4,000 songs. HDD Navigation functionality includes advanced speech recognition, 3D and topographical mapping display and advanced 3D building display



DVD Satellite Navigation display



Advanced 3D building display (part of Satellite Navigation – HDD-based)

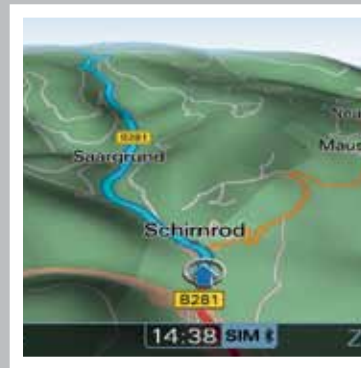

3D topographical mapping display (part of Satellite Navigation – HDD-based)

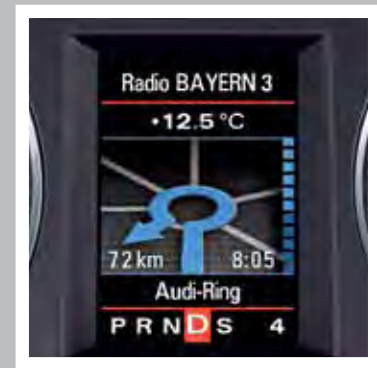

Colour Driver's Information System



A6 cockpit with Aluminium trigon inlays, Valcona leather in black and 3-spoke leather Sports multi-function steering wheel

# Audio and communication

Stay in touch using our range of communication functions, and give each journey its own soundtrack with our advanced audio equipment.

Options are subject to availability and may extend delivery.

- = Not available  
• = Available  
S = Standard

RRP – Recommended Retail Price.

All prices are subject to VAT at 20% reflecting the VAT rate most likely to be in force at the time of delivery. The VAT rate may change if the vehicle is delivered before 4 January 2011 or if the VAT rate subsequently changes.

Order Code		Standard	SE	S line	S line Special Edition	S6 quattro	Basic RRP	Total RRP inc VAT
QV3	<b>DAB digital radio.</b> Integrated into MMI, receives digitally-transmitted radio stations in addition to the range of analogue stations. Displays music track, artist and radio program. Reception dependent on local digital network. Automatic switch from DAB to FM reception if the network signal is not strong enough	•	•	•	•	•	£291.67	£350.00
QU1	<b>DAB digital radio in combination with TV reception – analogue and digital.</b> Only in combination with technology package – High	•	•	•	•	•	£975.00	£1,170.00
8RY	<b>BOSE® surround sound system.</b> 5.1 surround sound, dynamic noise-compensation, 8-channel amplifier, 13 loudspeakers including centre speaker in the dashboard and 2 surround loudspeakers in the rear shelf. Total output of 330 Watts	•	•	•	•	•	£487.50	£585.00
9ZX	<b>Mobile telephone preparation – Bluetooth interface.</b> Provides handsfree connection via Bluetooth using mobile phone aerial. Please contact your Audi Centre for phone compatibility. Only in combination with multi-function steering wheel	•	-	-	-	-	£216.67	£260.00
PT5	<b>Mobile telephone preparation – Low with Bluetooth and voice control.</b> Provides handsfree connection via Bluetooth using mobile phone aerial. Alternatively, it can use a cradle with charging facility for optimal reception via external aerial. Located in front centre armrest. Cradle available at extra cost – please contact your Audi Centre for phone compatibility	•	S	S	S	-	£362.50	£435.00
9ZW	<b>Mobile telephone preparation – High with Bluetooth.</b> Provides handsfree connection using an external aerial for optimal reception via a Bluetooth interface. Please note that your mobile phone must have SIM-Access Profile facility for full functionality. Only in combination with technology package – High or Low	•	-	-	-	-	£554.17	£665.00
		-	•	•	•	S	£191.67	£230.00



Mobile telephone preparation – High with privacy handset



BOSE® surround sound system

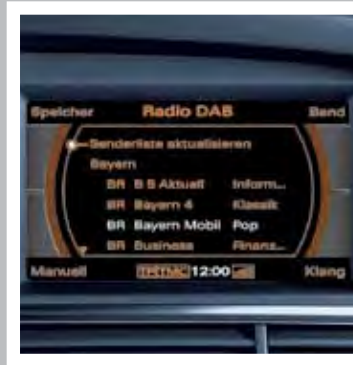

DAB digital radio



Mobile phone preparation – Low

# Audio and communication

Order Code		Standard	SE	S line	S line Special Edition	S6 quattro	Basic RRP	Total RRP inc VAT
PT4	<b>Mobile telephone preparation – High with Bluetooth privacy handset located in front centre armrest.</b> The cordless handset allows passengers to make private calls, provides remote control of the telephone functions as well as a convenient SMS text message function. The handset is charged from a docking station integrated into the front centre armrest. The SIM card can be put directly in the handset if the mobile phone does not have SIM-Access Profile (SAP). Only in combination with technology package – High or Low	●	–	–	–	–	£808.33	£970.00
		–	●	●	●	–	£445.83	£535.00
		–	–	–	–	●	£254.17	£305.00
UF7	<b>Audi Music Interface (AMI).</b> Universal connection for use with stereo audio sources, USB and MP3 devices including Apple iPod generation 4 onwards (iPod, iPod classic, iPod mini, iPod nano, iPod photo, iPod video, iPod touch). Provides intuitive control through the audio system and multi-function steering wheel. It also replicates the iPod display on the audio screen and DIS, including track titles. The interface provides charging function (dependent on device). Includes 2 cables to connect your iPod and USB MP3 device	●	●	●	●	●	£212.50	£255.00
7A6	<b>CD changer.</b> For six CDs with MP3 compatibility. Operated via MMI system. Located in glovebox	●	S	S	S	S	£254.17	£305.00
P14 9Q4	<b>Colour Driver's Information System (DIS)</b>	●	S	S	S	S	£108.33	£130.00
9WM	<b>Rear Seat Entertainment.</b> Includes two detachable DVD players/monitors fitted to the backs of the front seats (supplied by Audi Genuine Accessories). The backs of the front seats are fitted with mountings and power connections. The system can be used outside the car with a rechargeable battery or mains power connection, which is included in the package. Includes individual remote controls and two sets of headphones	●	●	●	●	–	£875.00	£1,050.00
QV9	<b>TV reception – analogue and digital.</b> TV tuner for reception of 'free-to-air' TV channels. Picture display only possible on MMI screen when vehicle is stationary, audio available at all times. Reception dependent upon local digital network availability. Only in combination with technology package – High	●	●	●	●	●	£679.17	£815.00

Options are subject to availability and may extend delivery.

- = Not available
- = Available
- S = Standard

RRP – Recommended Retail Price.

All prices are subject to VAT at 20% reflecting the VAT rate most likely to be in force at the time of delivery. The VAT rate may change if the vehicle is delivered before 4 January 2011 or if the VAT rate subsequently changes.



Rear Seat Entertainment



TV reception



Audio Music Interface



Mobile phone preparation – High

# Seats

Choose from a variety of different seat options so you can maintain the right driving posture at all times.

Options are subject to availability and may extend delivery.

- = Not available  
 • = Available  
 S = Standard

RRP – Recommended Retail Price.

All prices are subject to VAT at 20% reflecting the VAT rate most likely to be in force at the time of delivery. The VAT rate may change if the vehicle is delivered before 4 January 2011 or if the VAT rate subsequently changes.

Order Code		Standard	SE	S line	S line Special Edition	S6 quattro	Basic RRP	Total RRP inc VAT
4A3	<b>Heated front seats.</b> Individually controlled variable temperature adjustment	•	•	•	S	•	£254.17	£305.00
4A4	<b>Heated front and outer rear seats.</b> Individually controlled variable temperature adjustment	•	•	•	–	•	£466.67	£560.00
		–	–	–	•	–	£212.50	£255.00
7P1	<b>Electric lumbar support.</b> For front seats with horizontal and vertical adjustment	•	•	S	S	S	£170.83	£205.00
PV1	<b>Electrically-adjustable front seats.</b> Includes adjustment for height, forwards and backwards position, backrest angle and lumbar support	•	•	–	–	–	£637.50	£765.00
	Sports seats	•	•	•	•	S	£466.67	£560.00
PV3	<b>Electric front seats with driver's seat memory.</b> Includes adjustment for height, forwards and backwards position, backrest angle and lumbar support. Also includes memory for door mirrors and electrically adjusted steering column, if fitted. Only in combination with memory mirrors	•	•	–	–	–	£937.50	£1,125.00
	Sports seats	•	•	•	•	–	£766.67	£920.00
		–	–	–	–	•	£300.00	£360.00
PV6	<b>Electric front seats with driver's and front passenger seat memory.</b> Includes adjustment for height, forwards and backwards position, backrest angle and lumbar support. Also includes memory for door mirrors and electrically adjusted steering column, if fitted. Only in combination with memory mirrors	•	•	–	–	–	£1,062.50	£1,275.00
	Sports seats	•	•	•	•	–	£891.67	£1,070.00
		–	–	–	–	•	£425.00	£510.00
3X2	<b>Through-load facility.</b> Includes removable ski bag for transporting long objects	•	•	•	•	•	£137.50	£165.00
3LE	<b>Door armrest in leather.</b> Not available in combination with cloth seats	•	•	•	•	•	£179.17	£215.00



Door armrest in leather



Electric front seats

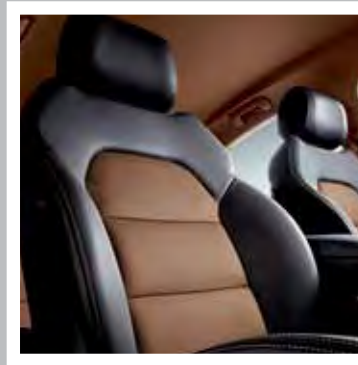

Sports seats, electric

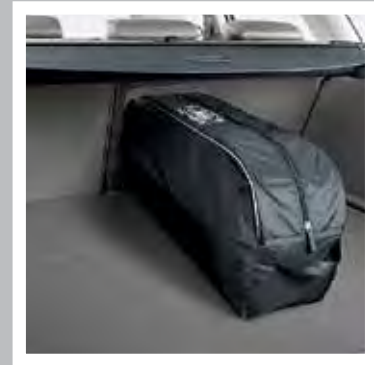

Through-load facility with removable ski bag





Alcantara/leather Sports seats with fine grain birchwood beige inlays

# Safety and security

Intelligent technology designed to give you better all-round awareness and safety on the road.

Options are subject to availability and may extend delivery.

- = Not available
- = Available
- S = Standard

RRP – Recommended Retail Price.

All prices are subject to VAT at 20% reflecting the VAT rate most likely to be in force at the time of delivery. The VAT rate may change if the vehicle is delivered before 4 January 2011 or if the VAT rate subsequently changes.

Order Code		Standard	SE	S line	S line Special Edition	S6 quattro	Basic RRP	Total RRP inc VAT
7X1	<b>Acoustic parking system (rear only).</b> Aids parking by acoustically indicating distances to obstacles	•	•	•	S	•	£279.17	£335.00
7X4	<b>Audi parking system plus.</b> Aids parking by acoustically and visually indicating distances to obstacles	•	•	•	-	•	£554.17	£665.00
		-	-	-	•	-	£275.00	£330.00
7X8	<b>Audi parking system advanced.</b> Aids parking by acoustically and visually indicating distances to obstacles with guiding lines. Measured by sensors and reversing camera	•	•	•	-	•	£808.33	£970.00
		-	-	-	•	-	£529.17	£635.00
PU1	<b>Audi lane assist.</b> Uses a discreet camera mounted at the top of the windscreen to monitor the road ahead. The driver is warned via a vibration of the steering wheel if the vehicle is about to exit the lane unintentionally. Only in combination with a 4-spoke multi-function steering wheel	•	•	-	-	-	£341.67	£410.00
7Y1	<b>Audi side assist.</b> Aids the driver when changing lane. Audi side assist monitors the area behind your car, using radar sensors located discreetly in the rear bumper, informing the driver with a visual warning signal in the door mirror if there is a vehicle in their blind spot or approaching quickly from behind. The system is activated using a button in the driver's door	•	•	•	•	•	£383.33	£460.00
PU2	<b>Audi side assist and lane assist.</b> Only in combination with a 4-spoke multi-function steering wheel	•	•	-	-	-	£725.00	£870.00
1T3	<b>First-aid kit</b>	-	•	•	•	•	£16.67	£20.00
4L6	<b>Auto dimming rear view mirror</b>	•	S	S	S	S	£104.17	£125.00



Acoustic parking system plus



Audi parking system advanced

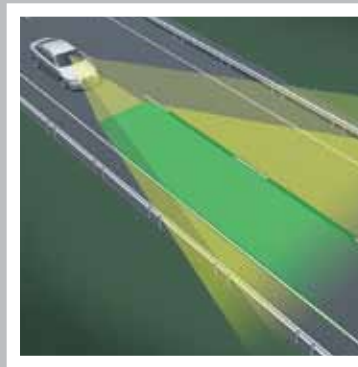

Audi lane assist



Audi side assist

# Safety and security

Order Code		Standard	SE	S line	S line Special Edition	S6 quattro	Basic RRP	Total RRP inc VAT
4L7	<b>Auto dimming rear view mirror with compass</b>	•	–	–	–	–	£170.83	£205.00
		–	•	•	•	•	£66.67	£80.00
4X4	<b>Rear side airbags.</b> Situated in side of rear seats	•	•	•	•	•	£254.17	£305.00
7K6	<b>Tyre pressure loss indicator.</b> A visual and acoustic warning is given when the system detects a potential loss of tyre pressure	•	•	•	•	•	£70.83	£85.00

Options are subject to availability and may extend delivery.

- = Not available
- = Available
- S = Standard

RRP – Recommended Retail Price.

All prices are subject to VAT at 20% reflecting the VAT rate most likely to be in force at the time of delivery. The VAT rate may change if the vehicle is delivered before 4 January 2011 or if the VAT rate subsequently changes.



# Interior equipment

Specify every detail of your car's interior with this range of exclusive options.

Order Code		Standard	SE	S line	S line Special Edition	S6 quattro	Basic RRP	Total RRP inc VAT	
8T4	<b>Adaptive cruise control (ACC).</b> Automatic distance regulation, using radar sensors to maintain required distance by braking and accelerating. Four programs (distance 1 to distance 4) set via steering column controls of the cruise control system. Standard models – only available in combination with Technology Package – Low	●	●	●	●	●	£937.50	£1,125.00	
4F2	<b>Advanced key.</b> Access and authorisation system which automatically exchanges data between key and vehicle, allowing the driver to keep the key in their pocket or bag at all times. To unlock and open, simply lift the exterior door handle. To lock, press the button on the handle. Pressing the start/stop button integrated in the centre console starts and stops the engine	●	●	●	●	●	£679.17	£815.00	
3FE	<b>Electric slide-and-tilt sunroof.</b> Includes position pre-selection, tinted glass insert, variable sunshield and convenience closing*	●	●	●	●	●	£725.00	£870.00	
3FR	<b>Electric slide-and-tilt solar-panel sunroof.</b> Includes position pre-selection and convenience closing. Uses the sun's energy to supply a constant flow of air to reduce the temperature inside a parked car*	●	●	●	●	●	£1,000.00	£1,200.00	
VC1	<b>Garage door opener (Homelink®**).</b> Programmable radio-operated remote control for compatible doors/gates. Control buttons integrated in the front roof module	●	●	●	●	●	£162.50	£195.00	
QQ1	<b>Light package.</b> Illumination of the area below the wing mirrors, ambient lighting of the centre console using red LED technology, ambient lighting of the door panels at the front and rear, active reflectors in front and rear doors, footwell lighting using LED technology and entry and exit lights at the front and rear	●	●	●	S	S	£191.67	£230.00	
PKH	<b>Luggage package.</b> Comprising universal net with fixing hooks and 12V socket. Only available on Saloon models	●	●	●	●	●	£62.50	£75.00	
QE1 PAC	<b>Storage package.</b> Comprising storage nets on front-seat backrests, storage compartment under front seats, net on side of centre console in passenger footwell and two drinks holders in rear armrest. Also includes universal net with fixing hooks on Avant models	Saloon	●	●	●	●	–	£70.83	£85.00
		Avant	●	●	●	●	S	£83.33	£100.00
3GN	<b>Load-area fixing kit.</b> Includes telescopic bar and securing belt for dividing up luggage compartment. Only available on Avant models	●	●	●	●	●	£108.33	£130.00	
4Y2	<b>Load-area lockable side compartment.</b> Includes storage compartment cover to right of luggage area which is lockable with vehicle key. Only available on Avant models	●	●	●	●	●	£33.33	£40.00	
6SJ	<b>Reversible load floor mat.</b> Luggage compartment floor mat can be reversed to provide a rubber mat which extends to protect rear bumper	●	●	●	●	●	£62.50	£75.00	
3Y1	<b>Rear window blind – manual.</b> Only available on Avant models	●	●	●	●	●	£83.33	£100.00	
3Y3	<b>Rear window and side window blinds – manual.</b> Only available on Avant models	●	●	●	●	●	£170.83	£205.00	
3Y2	<b>Rear window blind – electric.</b> Only available on Saloon models	●	●	●	●	●	£200.00	£240.00	
3Y5	<b>Rear window blind – electric.</b> Includes manual side window blinds. Only available on Saloon models	●	●	●	●	●	£275.00	£330.00	
6Q6	<b>Aluminium gear knob</b>	●	●	●	●	–	£108.33	£130.00	
6NQ	<b>Cloth headlining – black.</b> Only in combination with upholstery codes GD, GS, GT, LR and GU	●	●	S	S	●	£170.83	£205.00	

\*Not available on 2.0 TDi models.

\*\*Homelink® is a registered trademark of Johnson Controls. For information on compatibility, visit [www.homelink.com](http://www.homelink.com).

Options are subject to availability and may extend delivery.

– = Not available  
● = Available  
S = Standard

RRP – Recommended Retail Price.

All prices are subject to VAT at 20% reflecting the VAT rate most likely to be in force at the time of delivery. The VAT rate may change if the vehicle is delivered before 4 January 2011 or if the VAT rate subsequently changes.

# Interior equipment

Options are subject to availability and may extend delivery.

- = Not available  
• = Available  
S = Standard

\*The leather, stitching, seat belts and leather piping (where applicable) can be selected from any of the exclusive colours shown on page 36. The carpet colour can also be selected from any of the exclusive colours shown on page 36, except for Crimson red and Saddle brown.

\*\*Available in all the Audi exclusive colours shown on page 36 except for Alabaster white, Magnolia white, and Sand beige.

RRP – Recommended Retail Price.

All prices are subject to VAT at 20% reflecting the VAT rate most likely to be in force at the time of delivery. The VAT rate may change if the vehicle is delivered before 4 January 2011 or if the VAT rate subsequently changes.

Order Code		Standard	SE	S line	S line Special Edition	S6 quattro	Basic RRP	Total RRP inc VAT
<b>OMS</b>	<b>80-litre fuel tank.</b> Standard on quattro® models	•	•	•	•	S	£62.50	£75.00
<b>YSN S3G</b>	<b>Audi exclusive leather-covered cockpit on driver's side</b> (available in black leather only)*	-	-	-	-	•	£766.67	£920.00
<b>YSO S3G</b>	<b>Audi exclusive leather-covered dashboard with contrast stitching**</b>	-	•	•	•	•	£1,275.00	£1,530.00
<b>YTO S3G</b>	<b>Audi exclusive seat belts*</b>	-	•	•	•	•	£1,275.00	£1,530.00
<b>YSR S3G</b>	<b>Audi exclusive floor mats with leather piping.</b> Includes 4 floor mats for front and rear (cannot be combined with option YSQ/S3G – Audi exclusive carpets)*	-	•	•	•	•	£325.00	£390.00
<b>YSQ S3G</b>	<b>Audi exclusive carpets.</b> Includes 4 Audi exclusive floor mats with leather piping (cannot be combined with option YSR/S3G – Audi exclusive floor mats)*	-	•	•	•	•	£1,445.83	£1,735.00



Advanced key (start/stop button)



Exterior lighting integrated into door mirrors



Load-area fixing kit



Rear window blind – manual

# Exterior equipment

Make sure your car looks exactly as you want it to by selecting some of the striking options from our detailed list.

Options are subject to availability and may extend delivery.

- = Not available
- = Available
- S = Standard

RRP – Recommended Retail Price.

All prices are subject to VAT at 20% reflecting the VAT rate most likely to be in force at the time of delivery. The VAT rate may change if the vehicle is delivered before 4 January 2011 or if the VAT rate subsequently changes.

Order Code		Standard	SE	S line	S line Special Edition	S6 quattro	Basic RRP	Total RRP inc VAT
8N7	<b>High-beam assist.</b> Automatically adjusts headlights from high-beam to dipped-beam when another vehicle is approaching	-	•	•	•	•	£91.67	£110.00
PX4 8Q6	<b>Adaptive headlights.</b> Swivelling headlights for improved illumination of a winding road. Includes Xenon Plus headlights with LED daytime-running lights and headlight washers. Also includes kerb lights (not available on S6 models)	•	•	-	-	-	£1,129.17	£1,355.00
		-	-	•	•	•	£320.83	£385.00
4E5	<b>Automatically opening boot lid.</b> When you unlock the luggage compartment, the lid automatically opens to make loading easier. Only available on Saloon models	•	•	•	•	•	£25.00	£30.00
PGA	<b>Power-operated tailgate.</b> Opens and closes the boot lid electrically. Opened via radio-operated remote car key, button in the driver's door or the soft-touch button in the boot-lid recess. Closed by pressing the button on the inside of the boot lid. Only available on Avant models	•	•	•	•	•	£341.67	£410.00
PZH	<b>Power door closure.</b> Electrically operated power doors with soft close feature	•	•	•	•	•	£362.50	£435.00
4ZM	<b>Black styling pack.</b> Radiator grille-frame in highly polished black, number plate holder, window surround and roof rails in matt black	•	•	•	•	•	£383.33	£460.00
2Z7	<b>Deletion of engine technology designation at rear</b>	•	•	•	•	-	No charge	No charge
2Z0	<b>Deletion of model and engine technology designation at rear</b>	•	•	•	•	•	No charge	No charge
6XE	<b>Door mirrors – electrically folding</b>	•	•	•	•	•	£108.33	£130.00



Adaptive headlights with LED daytime-running lights



LED rear lights with model designation (Saloon)

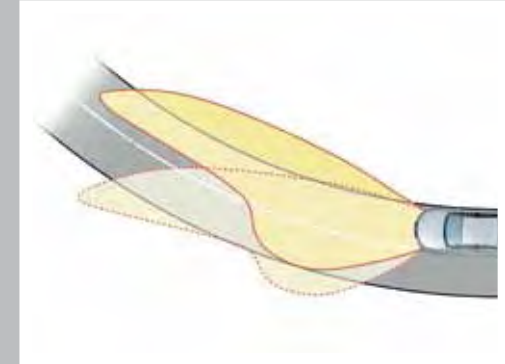

Adaptive headlight beam

# Exterior equipment

Order Code		Standard	SE	S line	S line Special Edition	S6 quattro	Basic RRP	Total RRP inc VAT
PAK	Door mirrors – electrically folding and auto-dimming	●	–	–	–	–	£316.67	£380.00
		–	●	●	●	●	£212.50	£255.00
PAH	Door mirrors – electrically folding and auto-dimming with memory function. Only in combination with electric front seats and memory function	●	–	–	–	–	£316.67	£380.00
		–	●	●	●	●	£212.50	£255.00
4KF	Privacy glass. Dark tinted glass from B-pillar backwards	●	●	●	●	●	£275.00	£330.00
PDG	Twin-pane UV and heat-insulating glass. Please note that the reflective layer may impede the operation of portable GPS, GSM or road toll devices. Not available on 2.0 TDi models. Not in combination with privacy glass	●	●	●	●	●	£725.00	£870.00
PDJ	Twin-pane UV and heat-insulating privacy glass. Please note that the reflective layer may impede the operation of portable GPS, GSM or road toll devices. Not available on 2.0 TDi models	●	●	●	●	●	£1,000.00	£1,200.00
1D4	Towing equipment – manual and swivelling	●	●	●	●	●	£637.50	£765.00



A6 Avant SE in Ice silver with 18" "5-spoke V" design alloy wheels and privacy glass

# Steering wheels

Our steering wheels are available in a range of textures and designs and can give you control of key vehicle features such as phone and stereo, as well as the automatic transmission (if selected).

\*The colour of the leather and stitching (where applicable) can be selected from any of the exclusive colours shown on page 36.

Options are subject to availability and may extend delivery.

- = Not available
- = Available
- S = Standard

RRP – Recommended Retail Price.

All prices are subject to VAT at 20% reflecting the VAT rate most likely to be in force at the time of delivery. The VAT rate may change if the vehicle is delivered before 4 January 2011 or if the VAT rate subsequently changes.

Order Code		Standard	SE	S line	S line Special Edition	S6 quattro	Basic RRP	Total RRP inc VAT
<b>1XW</b> (S line 2PU)	<b>3-spoke multi-function steering wheel.</b> Manual models only	•	•	S	S	–	£83.33	£100.00
<b>1XX</b> (S line 2FQ)	<b>3-spoke multi-function steering wheel with gear-shift paddles.</b> Automatic models only	•	•	S	S	S	£83.33	£100.00
<b>2ZD</b>	<b>Heated 4-spoke multi-function leather steering wheel with gear-shift paddles.</b> Automatic models only	•	•	–	–	–	£137.50	£165.00
<b>2ZM</b>	<b>Heated 4-spoke multi-function leather steering wheel.</b> Manual models only	•	•	–	–	–	£137.50	£165.00
<b>6F9</b>	<b>Wood and leather 4-spoke multi-function steering wheel with gear-shift paddles.</b> Includes wooden gear knob. Only in combination with walnut or fine grain birch wood inlays and not with Audi exclusive inlays	•	•	–	–	–	£200.00	£240.00
<b>P32</b>	<b>Wooden 3-spoke multi-function steering wheel with gear-shift paddles.</b> Includes wooden gear knob. Only in combination with walnut brown inlays. Automatic models only	•	•	–	–	–	£220.83	£265.00
<b>2C7</b>	<b>Electrically adjustable steering column.</b> Includes adjustment for height and reach and easy-exit function	•	•	•	•	•	£254.17	£305.00
<b>YRI</b> <b>S3G</b>	<b>Audi exclusive steering wheel in wood and leather.</b> Wood and leather can be chosen from the Audi exclusive inlays and leather colours respectively. (Only in combination with Audi exclusive wooden inlays)*	–	•	–	–	–	£612.50	£735.00
<b>YRH</b> <b>35G</b>	<b>Audi exclusive leather-covered steering wheel*</b>	–	•	•	•	•	£316.67	£380.00



3-spoke leather Sports multi-function steering wheel



Wooden 3-spoke Sports multi-function steering wheel



# Audi exclusive controls packs and gear levers

Our fingertips and palms contain more touch receptors than any other part of our body – so shouldn't the parts of our car we handle the most also be the most pleasing to touch? As with Audi exclusive seats, you even have free choice on the colour of the decorative stitching used. Choose a controls pack and you can extend this exclusive look and feel to your car's handbrake, gearknob and gaiter too.

\*Leather and stitching (where applicable) can be selected from any of the exclusive colours shown on page 36.

Options are subject to availability and may extend delivery.

- = Not available
- = Available
- S = Standard

RRP – Recommended Retail Price.

All prices are subject to VAT at 20% reflecting the VAT rate most likely to be in force at the time of delivery. The VAT rate may change if the vehicle is delivered before 4 January 2011 or if the VAT rate subsequently changes.

Order Code		Standard	SE	S line	S line Special Edition	S6 quattro	Basic RRP	Total RRP inc VAT
<b>YTD S3G</b>	<b>Audi exclusive gear lever in wood</b> (automatic models, only available in combination with Fine grain birch wood beige, Walnut brown or matching Audi exclusive inlays)	-	•	•	•	•	£187.50	£225.00
<b>YTG S3G</b>	<b>Audi exclusive gear lever in wood</b> (manual models, only available in combination with Fine grain birch wood beige, Walnut brown or matching Audi exclusive inlays)	-	•	•	•	-	£154.17	£185.00
<b>YRB S3G</b>	<b>Audi exclusive controls package</b> – includes leather-covered steering wheel and gear-shift gaiter*	-	•	•	•	•	£491.67	£590.00



## Service Plan

Choosing an Audi Service Plan provides an easy way to cover all your car's scheduled servicing with a convenient monthly payment plan. It can take care of everything from fluid and filter changes to your full service, ensuring you retain a full Audi service history. There are no servicing bills to plan for and you'll continue to benefit from today's prices for the length of your agreement.

Order Code		Standard	SE	S line	S line Special Edition	S6 quattro	Basic RRP	Total RRP inc VAT
-	<b>3-Service Plan.</b> Comprehensive package covering servicing costs for 3 services or 30,000 miles (whichever occurs sooner). Visit <a href="http://audi.co.uk/serviceplans">audi.co.uk/serviceplans</a> for full details including terms and conditions	●	●	●	●	●	£33.33	£40.00
-	<b>5-Service Plan.</b> Comprehensive package covering servicing costs for 5 services or 50,000 miles (whichever occurs sooner). Visit <a href="http://audi.co.uk/serviceplans">audi.co.uk/serviceplans</a> for full details including terms and conditions	●	●	●	●	●	£41.67	£50.00

## Warranty

Options are subject to availability and may extend delivery.

- = Not available  
● = Available  
S = Standard

\*Prices are based on the Audi Fixed Inspection Service Schedule and 10,000 miles per annum or less. For more information on the Service Schedule, please see page 69.

\*\*Only available when ordering your new Audi A6. Please speak to your Audi Centre for full details.

RRP – Recommended Retail Price.

All prices are subject to VAT at 20% reflecting the VAT rate most likely to be in force at the time of delivery. The VAT rate may change if the vehicle is delivered before 4 January 2011 or if the VAT rate subsequently changes.

Order Code		Standard	SE	S line	S line Special Edition	S6 quattro	Basic RRP	Total RRP inc VAT
-	<b>Audi Warranty,</b> covering you for unlimited mileage in the first 2 years of ownership, and up to 60,000 miles in the third year. Transferable between owners**	●	●	●	●	●	No charge	No charge
EA6	<b>Audi Warranty,</b> covering you for up to 4 years or 75,000 miles, whichever comes soonest. Cover includes a 2-year unlimited mileage warranty, and up to 75,000 miles in the third and fourth years. Transferable between owners**	●	●	●	●	●	£466.67	£560.00
EA9	<b>Audi Warranty,</b> covering you for up to 5 years or 90,000 miles, whichever comes soonest. Cover includes a 2-year unlimited mileage warranty, and up to 90,000 miles in the third, fourth and fifth years. Transferable between owners**	●	●	●	●	●	£1,112.50	£1,335.00

# Merchandise

From the enthusiasts' motorsport collection to the sophisticated Audi collection, there's a wide variety of adults' and children's clothing, lifestyle accessories and collectables, all of which bear the Audi name.

Please speak to a member of our team at your local Audi Centre to see the full Audi collection and to place an order. A selection of Audi merchandise is also available to buy from [audi.co.uk/merchandise](http://audi.co.uk/merchandise).



Audi kids



Bags and leather goods



Clothing



Motorsports



Sport and travel



Model cars

# Accessories

Choosing an Audi isn't just a matter of deciding on the model you want; it's about creating a car that suits your needs perfectly. And that's why we've developed a whole range of accessories to enhance your A6, enabling you to customise it down to the last detail. Like your Audi, all these accessories are developed to the highest possible standards. And they're all available exclusively from Audi.

To find out more, just visit [audi.co.uk/accessories](http://audi.co.uk/accessories) or contact your local Audi Centre.

## Warranty

All of the accessories available on the A6 are covered by a three-year warranty\* if they are ordered and included in the purchase price of the car at date of delivery. Any accessories ordered and installed after delivery include a two-year warranty.\*



Sport and design

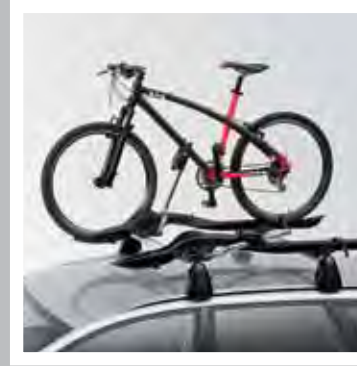

Transport and touring



Entertainment and communication



Comfort and protection

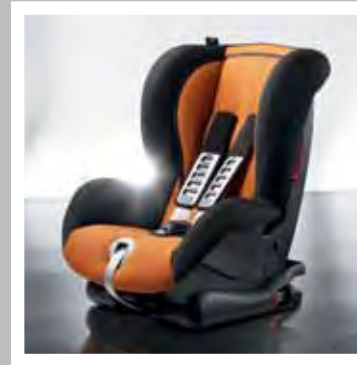

Family



Safety and security

\*Excluding Road Angel products.  
Audi Accessories warranty terms and conditions can be found at [audi.co.uk](http://audi.co.uk)

# A6 Saloon Petrol technical data

Engine	2.0 TFSI	2.0 TFSI	2.8 FSI	2.8 FSI quattro®	3.0 TFSI quattro®	S6 quattro®
Transmission	6-speed manual	7-speed multitronic	7-speed multitronic	6-speed tiptronic	6-speed tiptronic	6-speed tiptronic
Cylinder	4-cylinder	4-cylinder	V6	V6	V6	V10
Displacement, cubic cm	1984	1984	2773	2773	2995	5204
Max. power <sup>1</sup> , PS at rpm	170/4300	170/4300	220/5750	220/5750	290/4850	435/6800
Max. torque, Nm at rpm	280/1800	280/1800	280/3000	280/3000	420/2500	540/3000
0-62mph acceleration, seconds	8.2	8.5	7.3	7.7	5.9	5.2
Top speed <sup>2</sup> , mph	142	139	149	149	155*	155*
CO <sub>2</sub> emissions <sup>3</sup> , g/km	174	179	196	212	219	299
Benefit in kind (BIK) %	23%	24%	28%	31%	32%	35%
Fuel consumption, mpg (l/100km) Urban	27.7 (10.2)	27.2 (10.4)	23.9 (11.8)	22.2 (12.7)	21.4 (13.2)	15.3 (18.5)
Fuel consumption, mpg (l/100km) Extra Urban	47.9 (5.9)	46.3 (6.1)	44.1 (6.4)	40.9 (6.9)	39.8 (7.1)	31.0 (9.1)
Fuel consumption, mpg (l/100km) Combined	37.7 (7.5)	36.7 (7.7)	33.6 (8.4)	31.4 (9.0)	30.1 (9.4)	22.4 (12.6)
ABI insurance group 1-20/1-50**	15/29 E	15/29 E	16/33 E	16/33 E	17/38 E	20/43 E
Unladen weight <sup>4</sup> , kg	1520	1550	1570	1680	1725	1910
Gross weight limit, kg	2100	2130	2150	2260	2305	2490
Roof load limit/nose weight, kg	100/85	100/85	100/85	100/85	100/85	100/85
Max trailer load unbraked <sup>5</sup> , kg	750	750	750	750	750	750
Max trailer load with 12% gradient <sup>5</sup> , kg	1400	1500	1900	1900	1900	2100
Max trailer load with 8% gradient <sup>5</sup> , kg	1600	1700	2000	2100	2100	2100
Luggage compartment capacity, litres	546	546	546	546	546	546
Fuel tank capacity approx, litres	70	70	70	80	80	80

\*Electronically limited.

\*\*Highest insurance group rating shown. Group may be lower dependent on trim level. Please visit [www.thatcham.org/abigrouprating](http://www.thatcham.org/abigrouprating) for details.

<sup>1</sup>The given value was obtained in accordance with the specified measurement procedure (the respective current version of the Directive 80/1269/EEC).

<sup>2</sup>Top speed is achieved in top gear.

<sup>3</sup>The given values were calculated in accordance with the specified measurement procedure (the respective current version of Directive 80/1268/EEC). This information does not relate to a single vehicle and does not comprise part of the offer but is merely intended for the purpose of comparison between the different vehicle types.

<sup>4</sup>Vehicle's unladen weight without driver (calculated in accordance with the current version of Directive 80/1268/EEC). The fitting of additional equipment may increase the vehicle's unladen weight and drag coefficient, whereupon the potential carrying capacity and top speed will be correspondingly reduced.

<sup>5</sup>The engine's power output always goes down with increasing altitude. At 1,000m above sea level, and for every additional 1,000m, deduct 10% from the weight of the outfit (trailer load limit + gross weight of the towing vehicle).

**Please note:** The maximum power output figures are quoted in PS (or Pferdestärke, which is the metric equivalent of brake horsepower). To convert to brake horsepower, divide the PS figure by 1.0139.

# A6 Saloon Diesel technical data

Engine	2.0 TDIe	2.0 TDI	2.0 TDI	2.0 TDI	2.7 TDI	2.7 TDI	2.7 TDI quattro®	3.0 TDI quattro®	3.0 TDI quattro®
Transmission	6-speed manual	7-speed multitronic	6-speed manual	7-speed multitronic	6-speed manual	7-speed multitronic	6-speed tiptronic	6-speed manual	6-speed tiptronic
Cylinder	4-cylinder	4-cylinder	4-cylinder	4-cylinder	V6	V6	V6	V6	V6
Displacement, cubic cm	1968	1968	1968	1968	2698	2698	2698	2967	2967
Max. power <sup>1</sup> , PS at rpm	136/4000	136/4000	170/4200	170/4200	190/3500	190/3500	190/3500	240/4000	240/4000
Max. torque, Nm at rpm	320/1750	320/1750	350/1750	350/1750	400/1400	400/1400	450/1750	500/1400	500/1500
0-62mph acceleration, seconds	10.3	9.9	8.9	8.9	7.9	7.9	8.2	6.6	6.8
Top speed <sup>2</sup> , mph	129	127	140	135	144	141	143	155*	155*
CO <sub>2</sub> emissions <sup>3</sup> , g/km	139	151	149	153	164	169	189	179	189
Benefit in kind (BIK)%	19%	22%	21%	22%	24%	25%	29%	27%	29%
Fuel consumption, mpg (l/100km) Urban	40.4 (7.0)	38.7 (7.3)	37.7 (7.5)	38.7 (7.3)	34.0 (8.3)	35.3 (8.0)	30.1 (9.4)	31.7 (8.9)	30.4 (9.3)
Fuel consumption, mpg (l/100km) Extra Urban	65.7 (4.3)	57.6 (4.9)	60.1 (4.7)	56.5 (5.0)	56.5 (5.0)	51.4 (5.5)	48.7 (5.8)	52.3 (5.4)	48.7 (5.8)
Fuel consumption, mpg (l/100km) Combined	53.3 (5.3)	48.7 (5.8)	49.6 (5.7)	48.7 (5.8)	45.6 (6.2)	44.1 (6.4)	39.8 (7.1)	42.2 (6.7)	39.8 (7.1)
ABI insurance group 1-20/1-50**	13/25 E	13/25 E	14/28 E	14/28 E	15/30 E	15/30 E	15/33 E	16/37 E	16/37 E
Unladen weight <sup>4</sup> , kg	1550	1575	1565	1590	1635	1660	1765	1760	1785
Gross weight limit, kg	2130	2155	2145	2170	2215	2240	2345	2340	2365
Roof load limit/nose weight, kg	100/85	100/85	100/85	100/85	100/85	100/85	100/85	100/85	100/85
Max trailer load unbraked <sup>5</sup> , kg	750	750	750	750	750	750	750	750	750
Max trailer load with 12% gradient <sup>5</sup> , kg	1500	1600	1600	1600	1600	1800	1900	1800	1900
Max trailer load with 8% gradient <sup>5</sup> , kg	1700	1800	1800	1800	1800	1900	2100	2000	2100
Luggage compartment capacity, litres	546	546	546	546	546	546	546	546	546
Fuel tank capacity approx, litres	70	70	70	70	70	70	80	80	80

\*Electronically limited.

\*\*Highest insurance group rating shown. Group may be lower dependent on trim level. Please visit [www.thatcham.org/abigrouprating](http://www.thatcham.org/abigrouprating) for details.

All diesel engines are fitted with a Diesel Particulate Filter.

<sup>1</sup>The given value was obtained in accordance with the specified measurement procedure (the respective current version of the Directive 80/1269/EEC).

<sup>2</sup>Top speed is achieved in top gear.

<sup>3</sup>The given values were calculated in accordance with the specified measurement procedure (the respective current version of Directive 80/1268/EEC). This information does not relate to a single vehicle and does not comprise part of the offer but is merely intended for the purpose of comparison between the different vehicle types.

<sup>4</sup>Vehicle's unladen weight without driver (calculated in accordance with the current version of Directive 80/1268/EEC). The fitting of additional equipment may increase the vehicle's unladen weight and drag coefficient, whereupon the potential carrying capacity and top speed will be correspondingly reduced.

<sup>5</sup>The engine's power output always goes down with increasing altitude. At 1,000m above sea level, and for every additional 1,000m, deduct 10% from the weight of the outfit (trailer load limit + gross weight of the towing vehicle).

**Please note:** The maximum power output figures are quoted in PS (or Pferdestärke, which is the metric equivalent of brake horsepower). To convert to brake horsepower, divide the PS figure by 1.0139.

# A6 Avant Petrol technical data

Engine	2.0 TFSI	2.0 TFSI	2.8 FSI	2.8 FSI quattro®	3.0 TFSI quattro®	S6 quattro®
Transmission	6-speed manual	7-speed multitronic	7-speed multitronic	6-speed tiptronic	6-speed tiptronic	6-speed tiptronic
Cylinder	4-cylinder	4-cylinder	V6	V6	V6	V10
Displacement, cubic cm (valves per cylinder)	1984	1984	2773	2773	2995	5204
Max. power <sup>1</sup> , PS at rpm	170/4300	170/4300	220/5750	220/5750	290/4850	435/6800
Max. torque, Nm at rpm	280/1800	280/1800	280/3000	280/3000	420/2500	540/3000
0-62mph acceleration, seconds	8.5	8.8	7.6	7.9	6.1	5.3
Top speed <sup>2</sup> , mph	139	137	146	146	155*	155*
CO <sub>2</sub> emissions <sup>3</sup> , g/km	174	181	199	214	223	299
Benefit in kind (BIK)%	23%	25%	28%	31%	33%	35%
Fuel consumption, mpg (l/100km) Urban	27.7 (10.2)	26.9 (10.5)	23.5 (12.0)	22.1 (12.8)	21.2 (13.3)	15.3 (18.5)
Fuel consumption, mpg (l/100km) Extra Urban	47.9 (5.9)	45.6 (6.2)	43.5 (6.5)	40.4 (7.0)	39.2 (7.2)	31.0 (9.1)
Fuel consumption, mpg (l/100km) Combined	37.7 (7.5)	36.2 (7.8)	33.2 (8.5)	31.0 (9.1)	29.7 (9.5)	22.4 (12.6)
ABI insurance group 1-20/1-50**	15/29 E	15/29 E	16/33 E	16/33 E	17/38 E	20/43 E
Unladen weight <sup>4</sup> , kg	1590	1620	1640	1740	1790	1970
Gross weight limit, kg	2220	2250	2270	2370	2420	2600
Roof load limit/nose weight, kg	100/85	100/85	100/85	100/85	100/85	100/85
Max trailer load unbraked <sup>5</sup> , kg	750	750	750	750	750	750
Max trailer load with 12% gradient <sup>5</sup> , kg	1400	1500	1900	1900	1900	2100
Max trailer load with 8% gradient <sup>5</sup> , kg	1600	1700	2000	2100	2100	2100
Luggage compartment capacity, litres /rear seats folded flat	565/1660	565/1660	565/1660	565/1660	565/1660	565/1660
Fuel tank capacity approx, litres	70	70	70	80	80	80

\*Electronically limited.

\*\*Highest insurance group rating shown. Group may be lower dependent on trim level. Please visit [www.thatcham.org/abigrouprating](http://www.thatcham.org/abigrouprating) for details.

<sup>1</sup>The given value was obtained in accordance with the specified measurement procedure (the respective current version of the Directive 80/1269/EEC).

<sup>2</sup>Top speed is achieved in top gear.

<sup>3</sup>The given values were calculated in accordance with the specified measurement procedure (the respective current version of Directive 80/1268/EEC). This information does not relate to a single vehicle and does not comprise part of the offer but is merely intended for the purpose of comparison between the different vehicle types.

<sup>4</sup>Vehicle's unladen weight without driver (calculated in accordance with the current version of Directive 80/1268/EEC). The fitting of additional equipment may increase the vehicle's unladen weight and drag coefficient, whereupon the potential carrying capacity and top speed will be correspondingly reduced.

<sup>5</sup>The engine's power output always goes down with increasing altitude. At 1,000m above sea level, and for every additional 1,000m, deduct 10% from the weight of the outfit (trailer load limit + gross weight of the towing vehicle).

**Please note:** The maximum power output figures are quoted in PS (or Pferdestärke, which is the metric equivalent of brake horsepower). To convert to brake horsepower, divide the PS figure by 1.0139.

# A6 Avant Diesel technical data

Engine	2.0 TDIe	2.0 TDI	2.0 TDI	2.0 TDI	2.7 TDI	2.7 TDI	2.7 TDI quattro*	3.0 TDI quattro*	3.0 TDI quattro*
Transmission	6-speed manual	7-speed multitronic	6-speed manual	multitronic	6-speed manual	7-speed multitronic	6-speed tiptronic	6-speed manual	6-speed tiptronic
Cylinder	4-cylinder	4-cylinder	4-cylinder	4-cylinder	V6	V6	V6	V6	V6
Displacement, cubic cm (valves per cylinder)	1968	1968	1968	1968	2698	2698	2698	2967	2967
Max. power <sup>1</sup> , PS at rpm	136/4000	136/4000	170/4200	170/4200	190/3500	190/3500	190/3500	240/4000	240/4000
Max. torque, Nm at rpm	320/1750	320/1750	350/1750	350/1750	400/1400	400/1400	450/1750	500/1400	500/1500
0-62mph acceleration, seconds	10.7	10.2	9.2	9.2	8.2	8.2	8.4	6.8	7.0
Top speed <sup>2</sup> , mph	127	124	137	133	142	139	140	152	152
CO <sub>2</sub> emissions <sup>3</sup> , g/km	139	155	152	154	164	172	189	179	189
Benefit in kind (BIK)%	19%	23%	22%	22%	24%	26%	29%	27%	29%
Fuel consumption, mpg (l/100km) Urban	40.4 (7.0)	37.7 (7.5)	37.7 (7.5)	38.2 (7.4)	34.0 (8.3)	34.9 (8.1)	30.1 (9.4)	31.7 (8.9)	30.4 (9.3)
Fuel consumption, mpg (l/100km) Extra Urban	65.7 (4.3)	56.5 (5.0)	58.9 (4.8)	56.5 (5.0)	56.5 (5.0)	50.4 (5.6)	48.7 (5.8)	52.3 (5.4)	48.7 (5.8)
Fuel consumption, mpg (l/100km) Combined	53.3 (5.3)	47.9 (5.9)	48.7 (5.8)	47.9 (5.9)	45.6 (6.2)	43.5 (6.5)	39.8 (7.1)	42.2 (6.7)	39.8 (7.1)
ABI insurance group 1-20/1-50*	13/25 E	13/25 E	14/28 E	14/28 E	15/30 E	15/30 E	15/33 E	16/37 E	16/37 E
Unladen weight <sup>4</sup> , kg	1635	1645	1635	1660	1705	1735	1825	1820	1845
Gross weight limit, kg	2265	2275	2265	2290	2335	2365	2455	2450	2475
Roof load limit/nose weight, kg	100/85	100/85	100/85	100/85	100/85	100/85	100/85	100/85	100/85
Max trailer load unbraked <sup>5</sup> , kg	750	750	750	750	750	750	750	750	750
Max trailer load with 12% gradient <sup>5</sup> , kg	1500	1600	1600	1600	1600	1800	1900	1800	1900
Max trailer load with 8% gradient <sup>5</sup> , kg	1700	1800	1800	1800	1800	1900	2100	2000	2100
Luggage compartment capacity, litres /rear seats folded flat	565/1660	565/1660	565/1660	565/1660	565/1660	565/1660	565/1660	565/1660	565/1660
Fuel tank capacity approx, litres	70	70	70	70	70	70	80	80	80

\*Highest insurance group rating shown. Group may be lower dependent on trim level. Please visit [www.thatcham.org/abigrouprating](http://www.thatcham.org/abigrouprating) for details.

All diesel engines are fitted with a Diesel Particulate Filter.

<sup>1</sup>The given value was obtained in accordance with the specified measurement procedure (the respective current version of the Directive 80/1269/EEC).

<sup>2</sup>Top speed is achieved in top gear.

<sup>3</sup>The given values were calculated in accordance with the specified measurement procedure (the respective current version of Directive 80/1268/EEC). This information does not relate to a single vehicle and does not comprise part of the offer but is merely intended for the purpose of comparison between the different vehicle types.

<sup>4</sup>Vehicle's unladen weight without driver (calculated in accordance with the current version of Directive 80/1268/EEC). The fitting of additional equipment may increase the vehicle's unladen weight and drag coefficient, whereupon the potential carrying capacity and top speed will be correspondingly reduced.

<sup>5</sup>The engine's power output always goes down with increasing altitude. At 1,000m above sea level, and for every additional 1,000m, deduct 10% from the weight of the outfit (trailer load limit + gross weight of the towing vehicle).

**Please note:** The maximum power output figures are quoted in PS (or Pferdestärke, which is the metric equivalent of brake horsepower). To convert to brake horsepower, divide the PS figure by 1.0139.



# A6 Saloon dimensions

The technical drawings opposite show the exact dimensions of the A6 Saloon, so you can check everything – from whether the car will fit in your garage to whether your luggage will fit in the boot.

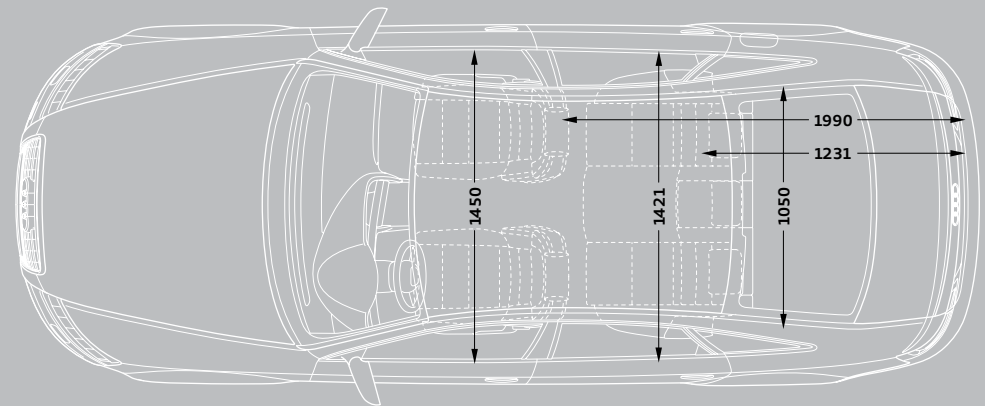
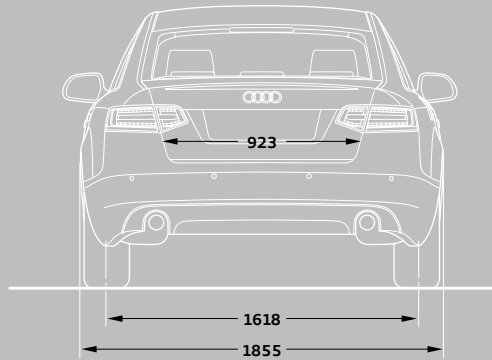
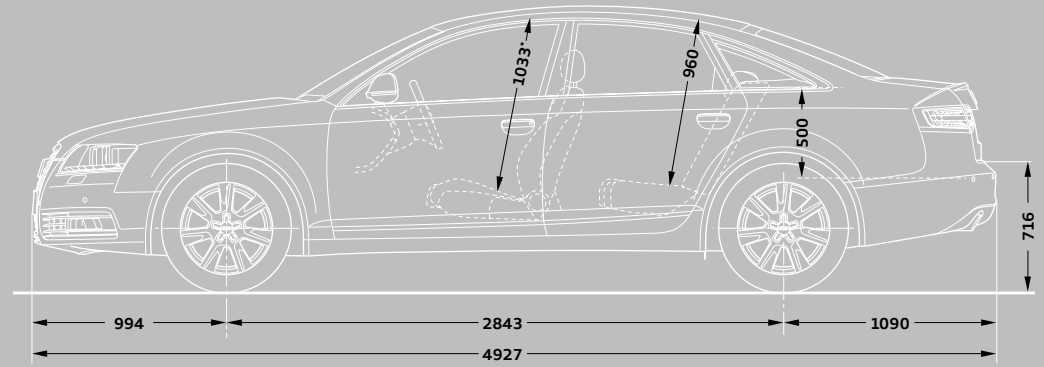
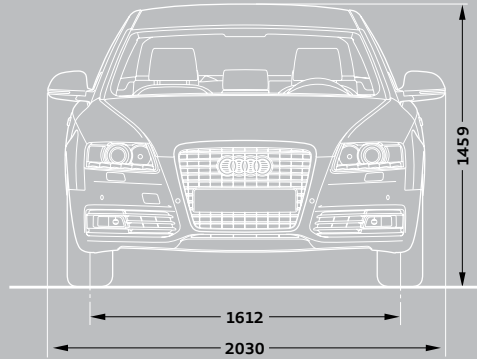

Dimensions were measured with vehicle at unladen weight.

Turning circle approx 11.9m.

Dimensions in millimetres.

\*Maximum headroom.

# A6 Avant dimensions

The technical drawings opposite show the exact dimensions of the A6 Avant, so you can check everything - from whether the car will fit in your garage to whether your luggage will fit in the boot.

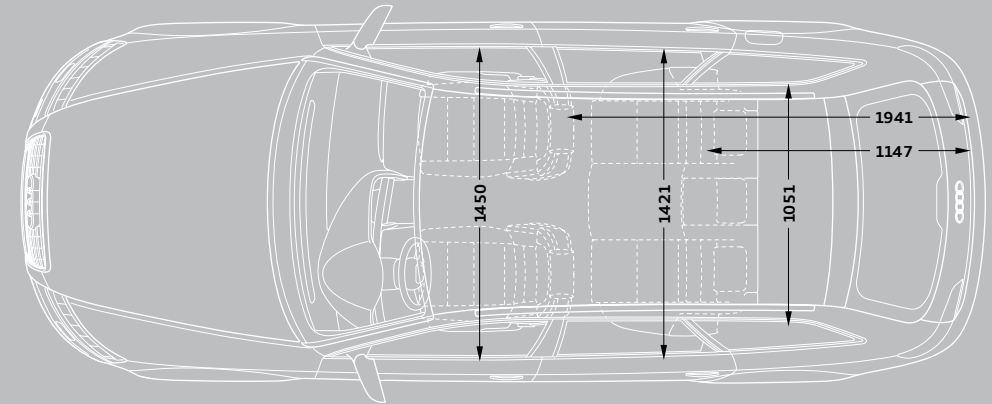
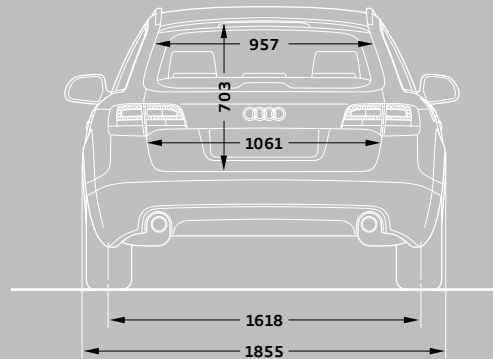
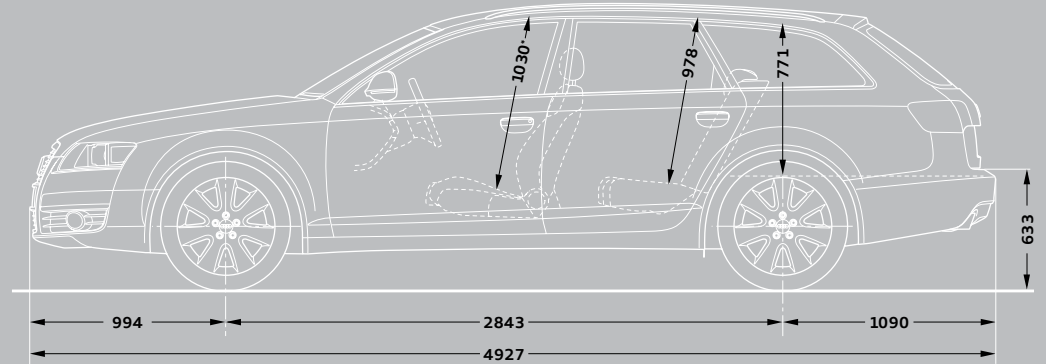
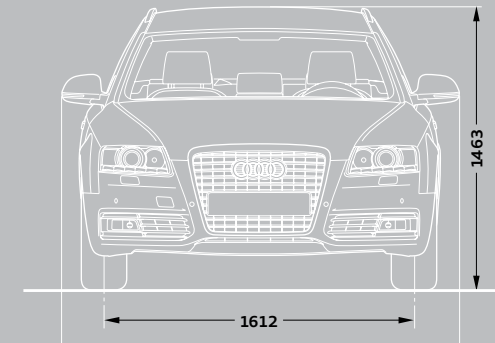

Dimensions were measured with vehicle at unladen weight.

Turning circle approx 11.9m.

Dimensions in millimetres.

\*Maximum headroom.

# S6 Saloon dimensions

The technical drawings opposite show the exact dimensions of the S6 Saloon, so you can check everything – from whether the car will fit in your garage to whether your luggage will fit in the boot.

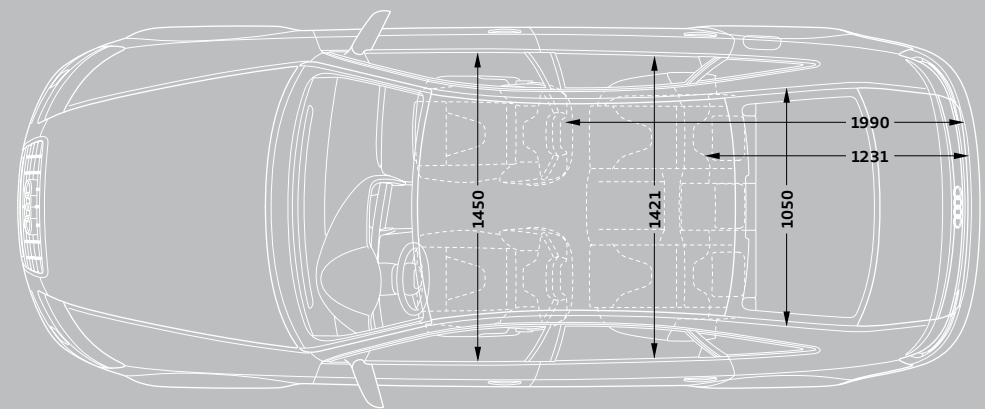
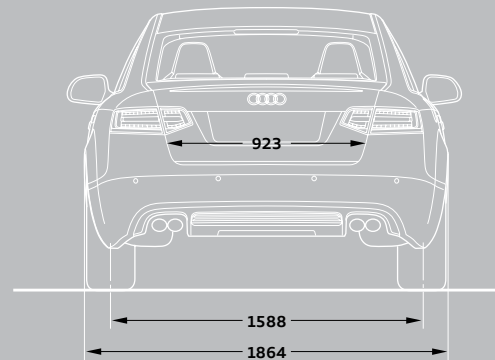
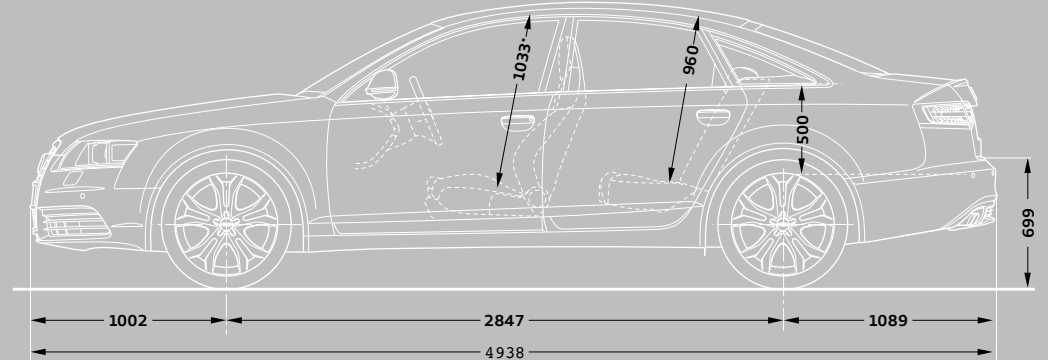
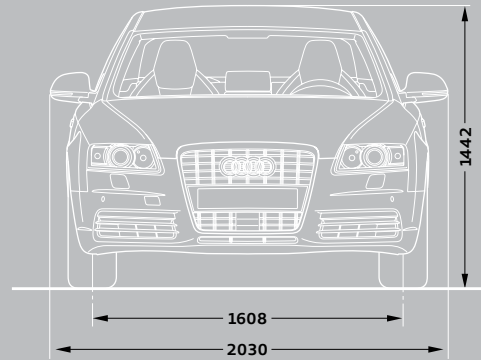

\*Maximum headroom

Dimensions were measured with vehicle at unladen weight.

Turning circle approx 11.9m

Dimensions in millimetres

# S6 Avant dimensions

The technical drawings opposite show the exact dimensions of the S6 Avant, so you can check everything - from whether the car will fit in your garage to whether your luggage will fit in the boot.

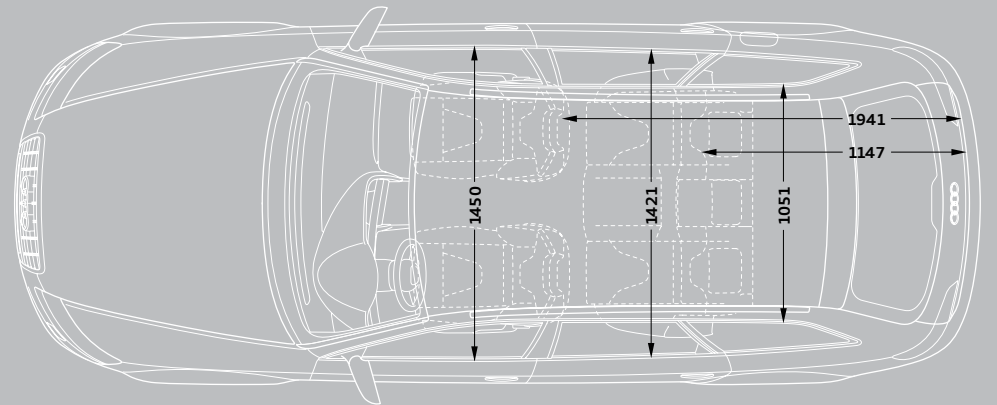
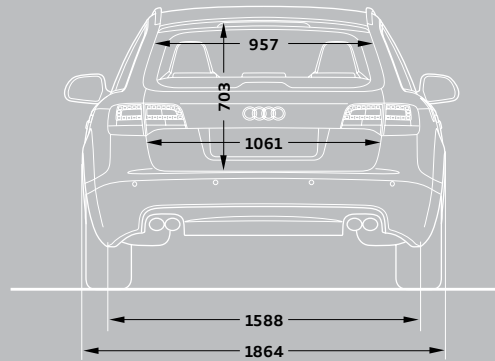
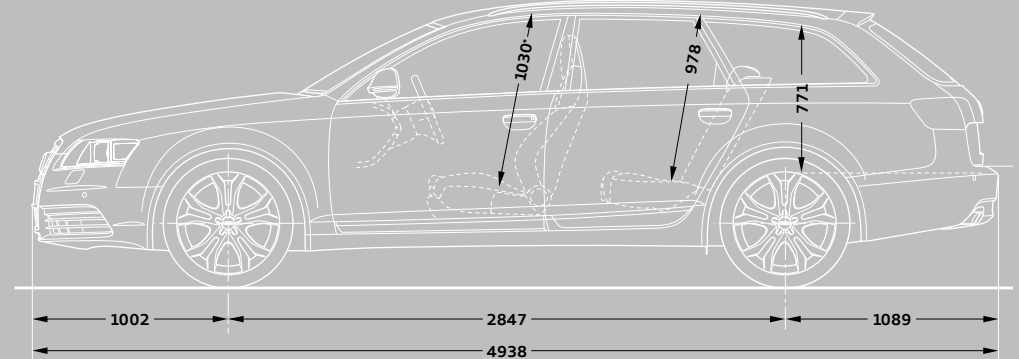
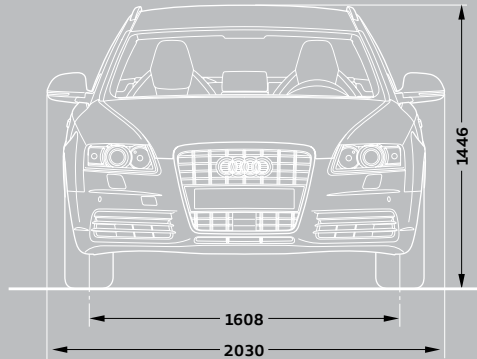

Dimensions were measured with vehicle at unladen weight.

Turning circle approx 11.9m.

Dimensions in millimetres.

\*Maximum headroom.

# Additional information

## CO<sub>2</sub> data and information

### CO<sub>2</sub> emissions-based Vehicle Excise Duty

Vehicle Excise Duty (Road Fund Licence) is based upon the amount of Carbon Dioxide (CO<sub>2</sub>) a vehicle emits, measured in grams per kilometre (g/km). The DVLA has created thirteen categories:

#### Petrol and Diesel engines

A - up to 100g/km	£0.00
B - 101 to 110g/km	£0.00
C - 111 to 120g/km	£0.00
D - 121 to 130g/km	£0.00
E - 131 to 140g/km	£110.00
F - 141 to 150g/km	£125.00
G - 151 to 165g/km	£155.00
H - 166 to 175g/km	£250.00
I - 176 to 185g/km	£300.00
J - 186 to 200g/km	£425.00
K - 201 to 225g/km	£550.00
L - 226 to 255g/km	£750.00
M - over 255g/km	£950.00

Vehicle Excise Duty (VED) rates correct at time of going to print, but these may alter to reflect any change in the applicable VED rate

### Servicing tailored to your needs

Regular servicing is key to safeguarding your Audi's performance and a full Audi service history could help you preserve the future re-sale value. To make servicing easy, the Audi Service Schedules have been designed to work with your individual driving style and vehicle.

There are two schedules available and your Audi Centre will advise which schedule is most suited to your needs. The conventional fixed Audi Inspection Service Schedule has fixed intervals for the Oil-change and Inspection Service that are based on time

and distance, whichever comes first. With the Audi LongLife Service Schedule, sensors take account of driving style and conditions in which the vehicle is used to indicate when the Oil-change Service is required. Oil-change Service intervals are therefore variable and are conveniently indicated via the on-board service interval display.

#### Fixed Inspection Service Schedule

	Vehicle usage:
Mileage	Less than 10,000 miles per annum
Type of journey	Mainly city/town centre driving. Short journeys
Conditions	Frequent cold starts. High engine loading – e.g. frequent hill climbs, vehicle fully loaded, towing
Driving style	Uneconomical – e.g. heavy acceleration, heavy braking, constant changes in speed, constant use of high revs, 'sporty' driving
	Service Intervals:
Oil-change Service	Fixed to every 9,000* miles/1 year
Inspection Service	Fixed to every 19,000* miles/2 years

#### Variable LongLife Service Schedule

	Vehicle usage:
Mileage	More than 10,000 miles per annum
Type of journey	Motorway and main road driving. Mainly longer distance journeys. Constant speeds
Conditions	Normal engine loading – e.g. with little or no towing, with little or no hill climbs. Normal vehicle loading
Driving style	Moderate acceleration, moderate braking, engine revs mainly below 3,000
	Service Intervals:
Oil-change Service	Variable to a maximum of every 19,000* miles/2 years
Inspection Service	Fixed to every 19,000* miles/2 years

\*As indicated by the service interval display. Mileages are approximate as the Service Indicator system uses kilometres as its distance measurement.

# Additional information

## Welcome to Audi

By placing an order for your Audi, you're choosing to get behind the wheel of one of the most sophisticated cars on the road. And because we believe the service we offer should be just as advanced, we wanted to let you know exactly what you can expect from us, now and in the future.

We've agreed a set of standards with all our Centres, which governs the way we do business with you. It outlines the kind of service we promise to deliver for every customer, right down to filling each new Audi we sell with half a tank of fuel.

So whether you're interested in the date your car will arrive in the UK or the way we'll dispose of non-biodegradable materials after we service your Audi, you can have total confidence in us.

## Audi Promise

### Audi Centres

We guarantee that all of our Centres will be open as follows:

Sales: Monday to Friday 9am–6pm  
Saturday 9am–5pm

Service: Monday to Friday 8am–6pm  
Saturday 8.30am–1pm

Sunday opening is at local discretion.

### New car delivery

Once we've confirmed a delivery date for your car, we'll keep you informed of progress. Subject to reasonable notice, we'll then deliver it to a place of your choice, whether that's your home or place of work. In the unlikely event of a delay, we'll provide a courtesy car to minimise inconvenience and keep you mobile.

### The experts in Vorsprung durch Technik

Would you entrust your Audi to anyone who hasn't been regularly trained to Audi standards? Our network of Audi Approved Master Technicians have undergone an impressive 100,000 hours of training over a 10-year programme to ensure they have the latest technical expertise for maintaining and servicing your Audi. All of our Service Advisors undergo a specialist induction and training to ensure they are Audi professionals and able to talk to you about any issues you may have with your Audi vehicle. What's more, we have so much expertise and experience in looking after Audi vehicles that we are able to make a note of your mileage and the state of your vehicle as and when we see it and predict when certain key events may occur. As part of our commitment to you, we will notify you in plenty of time so you can make an appointment with us.

### Your convenience comes first

At Audi you can choose from a range of convenient services that suit your needs. Why not book a 'service while you wait' appointment\* and enjoy our complimentary refreshments while your car is with us? Or, if you need to be mobile, take advantage of one of our courtesy cars which we can even collect and deliver to you.\* We guarantee we can service your Audi within 5 days without a courtesy car, or within 10 days if you need transport. We will also ensure your car is returned to you with a full valet.

### Audi Genuine Parts

Would you put a part into your Audi that wasn't the same quality as the factory fitted original? You can rest assured that only Audi Genuine Parts will be used on your vehicle. What's more, Audi parts and labour come with a 2-year guarantee.\*\* We stock a wide variety of parts, so we are well covered. However, if we don't have a part in stock at our Centre we have the back-up of parts at other Audi Centres, at our national warehouse and our factory and can usually source the relevant part very quickly.

### We don't like surprises either

We believe strongly in transparency and there will be no hidden costs. For added peace of mind, we will give you a quotation over the phone for the work you have requested and email you the price confirmation. We'll consult you if any additional work on your car is needed when it is with us. We won't carry out any extra work without asking your permission first.

### The Audi Stamp

Regular servicing is key to safeguarding your Audi's performance and a full Audi service history could help you preserve the future re-sale value of your car. Only the Audi Stamp will prove your approved Audi service history.

### Getting better every time

We continually gather feedback from our Audi Trained Technicians, as well as our customers, to ensure our vehicles are running as they should. Whenever we see an Audi for a service, we connect it directly to our headquarters in Ingolstadt which enables us to check your car's software and make sure it's as up-to-date as possible. If the factory has released a software upgrade for your model, it can be applied immediately – improving anything from your car's efficiency to the precision of its parking system.

### Environmental commitment

We promise to dispose of all non-biodegradable materials from your vehicle in a responsible manner.

\*Subject to availability.

\*\*Excludes wear and tear.

# Pricing information

## Pricing

Prices and specifications given are correct at the time of printing. Always check details with your Audi Centre, as Audi policies are continually developing. We reserve the right to change prices or specifications at any time.

All prices are subject to VAT, currently charged at 20% but this may alter to reflect any change in the applicable VAT rate.

Delivery charges and number plates are not included in the vehicle price.

Delivery charge	£471.66
Number plate	£20.00
VAT	£98.34
Total	£590.00

## Audi Roadside Assistance

Your new car comes complete with 3 years' complimentary roadside assistance and recovery across the UK provided by RAC Motoring Services. Also included is roadside assistance throughout Europe, managed by RAC Motoring Services.

For further information and terms and conditions please visit [audi.co.uk](http://audi.co.uk)

## Audi Customer Care

Every new Audi benefits from the comprehensive Audi Customer Care Package, which comprises:

- ▶ A 3-year Audi warranty, which covers you for unlimited mileage in the first 2 years of ownership, with a full mechanical and electrical warranty which covers you for up to 60,000 miles in the 3rd year

- ▶ A 3-year paint warranty
- ▶ A 12-year anti-corrosion warranty
- ▶ 3 years' UK roadside assistance and recovery

You also have the option when ordering your new car of choosing a 4-year or 5-year Audi warranty. Speak to a member of the sales team for more information.

## Audi Tax-Free Sales

If you are entitled to purchase a vehicle free of VAT, normally through Military or Diplomatic privilege, please contact your Audi Centre. Should you have any difficulty obtaining the information you require, please call Freephone 0800 585878.

## Audi Finance

Audi Finance specialise in providing funding solutions for Audi drivers. Whether your Audi is for private or business use, there are a range of funding options to choose from.

Below is the full range of finance products.

- ▶ Solutions – a Personal Contract Plan
- ▶ Hire purchase
- ▶ Lease purchase
- ▶ Finance lease
- ▶ Contract hire

With all products, you can choose a fixed-cost maintenance plan designed to help you budget accurately.

No matter what Audi model you choose, your local Audi Centre can provide you with

a personalised quote which could fit your budget and motoring needs.

Audi Finance is a trading name of Volkswagen Financial Services (UK) Limited. An offer of finance depends on certain conditions. Available to people over 18 in the UK only.

## Audi Insurance

We want you to start enjoying your new car from day one and thanks to Audi Insurance complimentary seven day cover, you can. Call free on 0800 316 7893 (lines are open Monday to Friday 8am - 9pm, and Saturday 9am - 5pm), provide a few details and a cover note will be sent to your Audi Centre. They will then tax your car and you can drive it away.

Audi Insurance is a trading name of Volkswagen Insurance Service (Great Britain) Limited, an appointed representative of Volkswagen Financial Services (UK) Limited, Brunswick Court, Yeomans Drive, Blakelands, Milton Keynes MK14 5LR. Registered in England number 2835230. Audi Insurance is sold, underwritten and administered by Allianz Insurance plc registered in England number 84638. Registered office 57 Ladymead, Guildford, Surrey GU1 1DB. Volkswagen Financial Services (UK) Limited and Allianz Insurance plc are authorised and regulated by the Financial Services Authority. Volkswagen Financial Services (UK) Limited and Allianz Insurance plc are not part of the same corporate group.





**Audi UK**

Customer Services  
Selectapost 29  
Sheffield  
S97 3FG  
0800 699888  
audi.co.uk

Specifications and prices subject  
to change without notice.

© Audi (UK)

Printed in the UK  
Edition 5.0 10/10  
2011 Model Year

Images are for illustrative purposes only.