

VOLVO

244

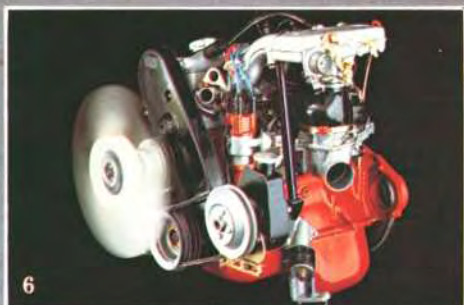



There is nothing quite like a Volvo

When you hear the name "Volvo", you probably immediately think of safety-and rightly so. But "Volvo" means far more-it means a car which embodies a unique combination of quality, durability and reliability, coupled

with a high standard specification, and exceptional value for money. These we call the "Volvo virtues" and it's these virtues which have meant that 3 out of every 4 Volvo owners buy another Volvo when changing their car. For 1981, you'll



find that the traditional "Volvo virtues" are retained and enhanced. But you will also find an elegant new exterior, a completely redesigned dashboard, a spoiler on GL, GLE & GLT models, and new improved bumpers, plus many

other refinements which indicate that this year's models represent another significant step forward.

In this brochure, we will describe the 1981 Volvos. But the only way to really appreciate them is to take a test drive. So why not try the

new generation Volvos for yourself? You will find your Dealer's address and telephone number in Yellow Pages or by telephoning Volvo Customer Services on High Wycombe (0494) 33444. (UK only).



The new Volvo features for 1981:

1. New front end and headlights
2. New integral wrap around safety bumpers
3. New grille
4. Distinctive new window surround
5. New, redesigned dashboard
6. The new B23E engine (136hp)-
244 GLT



The choice is Yours

The new 1981 model Volvo 244 saloons come in 4 different variants—the 244DL, 244GL, 244GLE and the powerful 244GLT. All are exceptionally well equipped as standard, with the GL, GLE and GLT offering particularly refined performance.

A guide to the various specifications appears at the back of this brochure to assist you in choosing the combination most appropriate to your requirements.

The 244GL has tinted glass, metallic paint, sunroof, ribbed plush upholstery, and overdrive as standard. It's powered by the 2.1 litre carburettor engine. The GLE has an economical, but more powerful, fuel injection engine, electrically operated front windows and a choice of leather or plush upholstery according to exterior colour. Both models have distinctive chromium trim above the bumper and an aerodynamic spoiler to reduce wind resistance.

1. The 244DL uses the 107 hp 2.1 litre carburettor engine. It has an unrivalled standard specification which includes headlamp wipers/washers, electrically

heated driving seat, rev counter, interior adjustable door mirror, and a high degree of colour coordination including pile carpeting and cloth upholstery.

2. The new 244GLT is powered by the newly-developed B23E fuel injection engine (136hp) which gives acceleration of 0-60 mph in 10 seconds. Technically the chassis has been developed to complement the extra power-special stabilisers, gas filled rear shock absorbers, ventilated disc brakes at the front, power assisted steering, overdrive and mag/alloy wheels with special low profile tyres.



1



2







Make Yourself really comfortable

There's more to comfort than just sinking into deep soft cushions. Seats should be soft, but they must also be firm enough to provide adequate support, especially for drivers who do extremely high mileage each year.

The widely acclaimed Volvo driver's seat is the result of extensive research and cooperation between Volvo designers and orthopaedic specialists. It features the world famous Volvo lumbar support and the seat cushion and backrest are electrically heated with the element switching on automatically at temperatures below 14 °C.

The Volvo driver's seat can also be raised or lowered by levers to help you find your ideal position. Your rear seat passengers ride in comfort as well because the seats are well shaped, have a centre armrest and seat belts as standard and rear leg room is exceptionally good.

The 1981 model Volvo feels light, precise and easy to handle. All controls are within easy reach. Overall visibility is excellent. Once behind the wheel, you'll feel everything is right where it should be. And there is the new Volvo instrumentation. All this will help you feel fresh and alert even after hours of driving!

1. The famous Volvo seats have integrated, see-through head restraints. The unique Volvo lumbar support is easily adjusted by means of a large knob at the side.

2. Front seat backrests are infinitely adjustable down to a fully reclined position.

3. Small turning diameter of only 32' 2" makes for easy manoeuvring in tight spots.

4. The well tested Volvo heating and ventilation system cools your face while it changes the air. You'll find it extremely efficient-14 vents let you direct the air to the exact spot where you want it!

5. You'll appreciate the many small, thoughtful details like the illuminated, lockable glove box with its fold-down tray and vanity mirror.

6. The GLE offers the option of genuine leather upholstery as standard dependent on exterior colour (DL & GLT have cloth upholstery, GL has ribbed plush as standard).

7. An opening in the rear seat when needed lets you stow long and narrow fragile objects well protected inside the car.

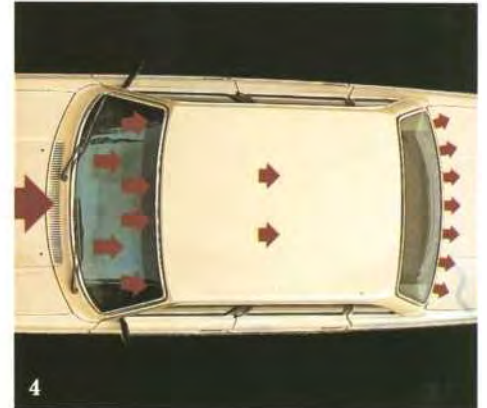

Put yourself in the driver's seat

Driving today, whether at high motorway speeds or in congested traffic, demands continuous concentration. You have to be alert and capable of absorbing a continuous stream of information and reacting in a split second to an ever-changing environment.

This means the driver's area must be designed to provide you with the maximum of comfort, visibility and control.

Look around you ! From your driver's seat you will experience extraordinarily good all-round visibility (a full 91%). Washers/wipers, effective demisters and defrosters, electrically heated rear

window, a large, antidazzle interior mirror and a door mirror adjustable from inside make sure that you keep that visibility at all times and in all weather conditions. Look down! The new exciting dashboard contains an impressive array of instruments. From the moment you sit down, the "Fasten seat belt" light starts flashing the first message. During driving, all functions are supervised and signals are given should anything require attention. And, even as you leave the car the system is still working : the Volvo warning buzzer will remind you that you have left the key in the ignition or your headlights on.

Another feature of your Volvo is that the instruments only light up when needed. During normal

driving, you see a few, like the speedometer, the rev counter and fuel and coolant temperature gauges. Others, like the brake failure warning, or the unique bulb integrity sensor do not light up until you need to be reminded. In practice, this means you are not distracted by a series of lights when driving under normal conditions-you are left in peace to concentrate on the road.

Now look at the controls. Ergonomically designed and refined over the years they are ready to respond to your every need. They are right there at your fingertips. The controls for windscreen wiper/washer, headlamp wiper/washer, main/dipped beam, and turn indicators are all on stalks on the steering





column. All the other controls too are easily accessible, as the illustration below demonstrates. The new dashboard has a compartment on the left where extra instruments can be fitted, and also features two new shelves for sunglasses, sweets etc., one right over the glove box, the other

on top of the centre console, which has been moved 35 mm closer to the driver to make controls easier to reach.

1. The anti-dazzle exterior rear view mirror is adjustable from inside the car.
2. The new overdrive button automatically disengages when changing down, so that you do not inadvertently go right back into overdrive when engaging 4th gear again.
3. The DL, GL and GLE can be obtained with fully automatic transmission.



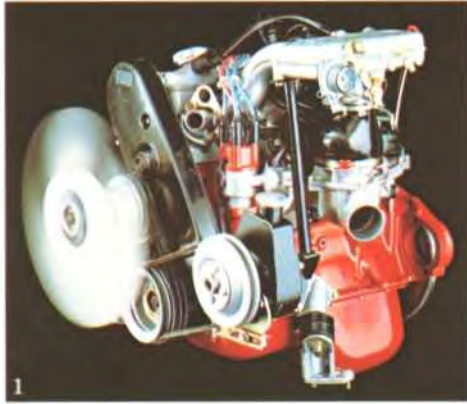

The 244 GLT-The first performance car that's as safe as a Volvo

This special high performance variant is widely used by the police so its speed and handling have got to be good. Fitted with the 136 hp B23E engine, it accelerates from 0 to 60 mph in 10 seconds!

That is faster, according to Motor Magazine, than the BMW 525. But the engine is only half the story.

The chassis has been especially developed to complement the extra power, with gas-filled rear shock absorbers, special stabilizers, and light alloy wheels with special low profile tyres. The four-speed manual gearbox has overdrive fitted on top gear and the GLT is the only 240 series car to be equipped with power steering as standard.

The GLT also boasts an exclusive exterior, with its all-black bumpers, front spoiler, wide black side trim moulding with rubber insert, distinctive silver GLT emblem front and rear and the unmistakable rear black area between the extra large tail lamp clusters.

The GLT also has a sunroof and tinted windows as standard and is available in two distinctive metallic colours, wine red and silver.

For a complete list of standard and optional equipment, please consult the check list at the back of this brochure.

1. The newly-developed B23E engine has an output of 136 hp.

2. Light alloy 5 spoke rims with 195/60 HR tyres are standard on the GLT.

3. The distinctive black window and side trims distinguish the GLT.

4. The GLT is equipped with extra large tail lamps, and the area between these is black.





Volvo's extra safety margin

Over the years Volvo engineers have ensured that our cars have been refined and developed to provide you with real driving pleasure. So you don't have to drive very fast or face a dangerous situation to know that your 1981 Volvo has light and responsive steering and braking, good acceleration for overtaking, sure-footed stability and roadholding and minimal roll when cornering.

If you have not driven a Volvo for some time, or you have never driven one and believe that Volvos are heavy to drive you're in for a big surprise when you get behind the wheel of the new 1981 models.

Power when you really need it
In today's inflationary environment very few people will admire you for getting away at a green light with a screech of

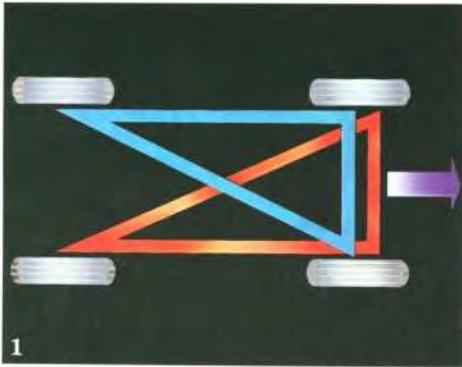

burning rubber. But this does not mean that power and acceleration are not important. Rather it means that you should have power when you need it-when overtaking. That is why Volvo engines have been designed to give their utmost in power in that critical 45-70 mph range.

Dual circuit reliability

Volvos have a triangle-split dual circuit braking system, including a stepped-bore master cylinder. This means that if one circuit should fail, both front brakes and one rear will still operate, retaining about 80% braking effect with maximum directional stability. The brake pedal feels and works almost as normal, and so does not cause the driver to panic. In fact the only thing you would probably notice is the warning light on the dashboard.

Steering that you control

The 1981 Volvo rack and pinion steering gives a light and precise steering response with a carefully balanced time-lag between steering wheel movement and wheel movement. The car responds in exactly the way the average motorist expects: it's stable *and* predictable.

Constant wheel angle and track -good road holding

The Volvo 244 has spring strut front suspension and a live rear axle. The movement of the rear axle is controlled by two support arms, two torque rods which prevent wind-up during acceleration and braking, and a track rod which holds the axle laterally. Coil springs, a stabilizer and shock absorbers complete the picture. The benefit of this arrangement is that it fully conveys the feel of the road to the driver. This adds to driver comfort and increases your control of the car.

1. Triangle-split dual braking system retains a full 80% of power even with one circuit out of operation.

2. Volvo engines give maximum power when needed-e.g. when overtaking-in the 45-70 mph speed range.

3. Among other things, the near-ideal weight distribution and advanced suspension contribute to Volvo's superior road-holding qualities.



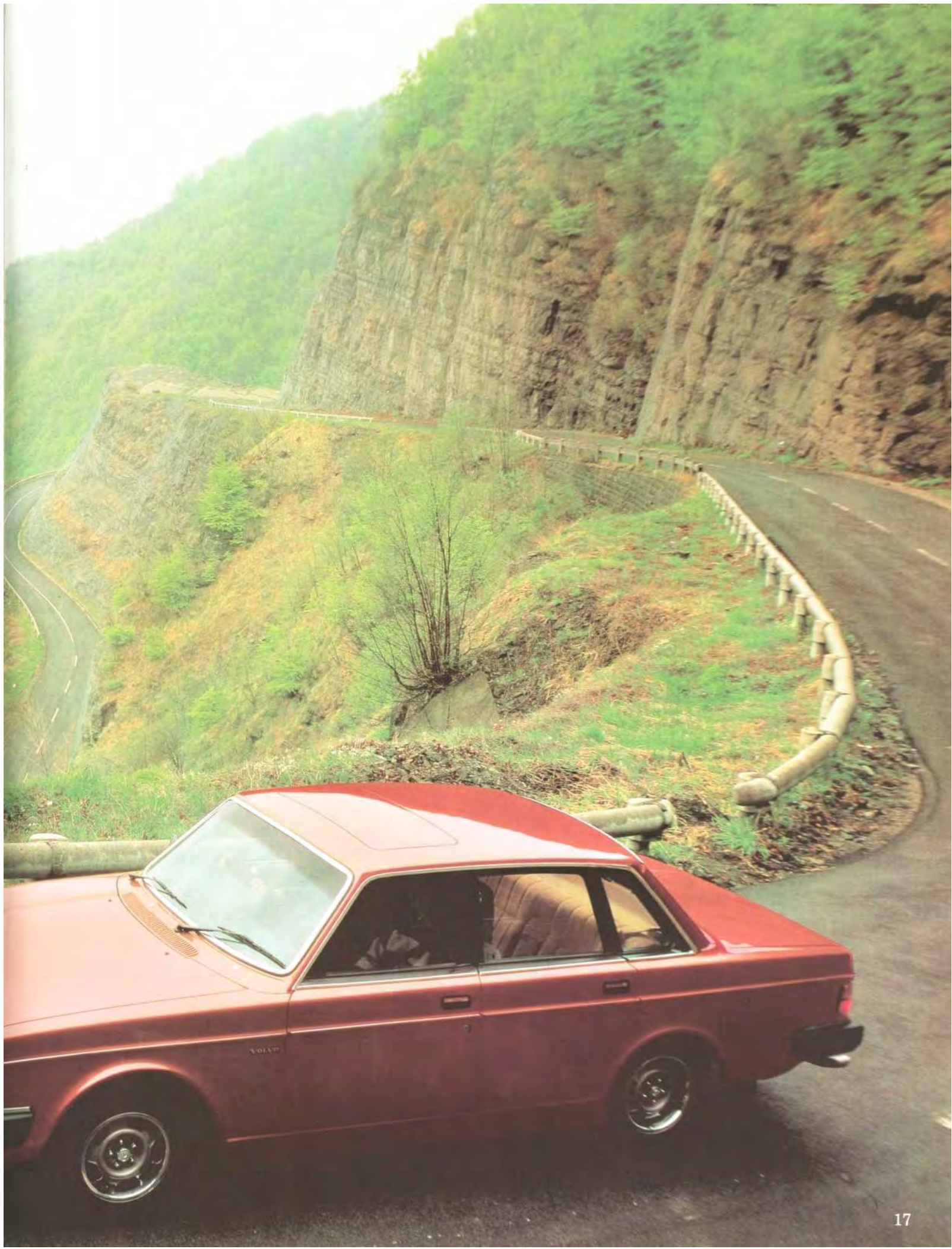

Volvo life insurance

Volvo is internationally acknowledged as a pioneer within the field of crash safety among car manufacturers. These efforts have won Volvo many international awards, but they have also saved lives-ask any Volvo owner who has ever been in a crash what "Volvo safety" really means.

Modern safety belts owe much of their present proven effectiveness to extensive pioneering work by Volvo. Today, all Volvos have three-point safety belts as standard front and rear. The inertia reel lets you move freely when there is no stress on the belt-and a flashing light reminds you to wear it-always!

Volvo interior safety includes careful design and ample padding inside the car-as well as crash-resistant front seats. The front seats incorporate head restraints and withstand many times the test loads stipulated by law.

The high-impact, laminated windscreen is so strong and so securely fastened to the body that it will withstand the weight of a person who (as a result of not wearing a belt) is thrown against it in a barrier crash at a speed of 30 mph.

1. Crumple zones front and rear. The unusually long energy-absorbing front means that, in a collision, a Volvo 200 series will crumple and absorb much of the impact instead of transferring it direct to driver and passengers. Also, upon impact the engine will slide down and under-instead of into -the passenger compartment.

2. The Volvo steering gear is designed to fold, crumple and telescope under extreme pressure in order not to transfer the crash impact to the driver.

3/4. The legendary Volvo "safety cage" around the passenger area is another Volvo first. All body apertures are reinforced by exceptionally strong box type steel profiles. Another unique Volvo feature is the strong steel tubes inside the doors for side impact protection.

5. The fuel tank is specifically located away from the rear bumper, but outside the safety cage. The top end of the fuel pipe is fastened to the outer body by means of a rubber fitting. This means that in the event of a collision, the screw cap stays securely in place even if the pipe is disconnected from the body.

6. The new 200 series Volvos have strong bumpers (the front mounted on telescopic shock absorbers.) They'll withstand minor crashes (at speeds up to 2 mph) without any damage whatsoever to the body.

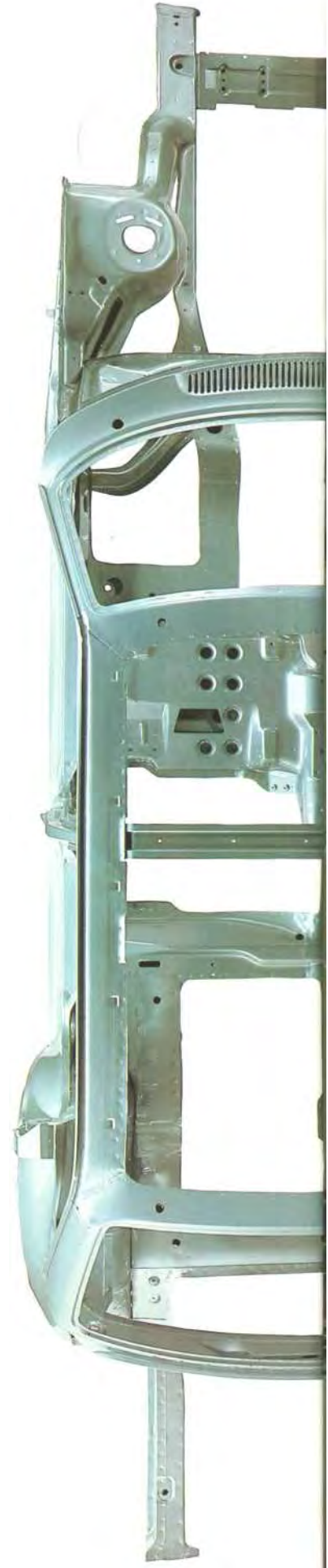

Volvo life expectancy

Official statistics* show Volvo to have the longest life expectancy of all cars on the Swedish market -and its lead is increasing every year. Last year showed Volvo with 17.9 years-which is a good 22 years more than its closest competitor, Mercedes Benz, with 15.2 years. Then come Volkswagen with 14.3 years, BMW with 13.5, Ford with 12.9, Peugeot with 11.6 ...

Now we don't expect everybody to keep their new Volvo for nearly 18 years, but the figures (and a number of other international independent surveys which back them up) do indicate Volvo's superior overall quality. This long life expectancy also contributes to good total economy and certainly helps you get a good second-hand price when you do decide to exchange your Volvo for a new model at some time in the future. Maybe this is one reason why 3 out of 4 Volvo owners buy another Volvo when changing cars.

One reason why Volvos hold their price so well is their durability and reliability coupled with exceptionally high specifications. To protect this investment most Volvo owners ensure that their car is properly serviced by an authorised Volvo dealer.

Another reason why Volvos hold their value is the body protection treatment given to all Volvo cars in order to protect them from the Swedish winter. After a multi-stage painting process, rustproofing agents are applied not only to the underbody of the car, but also inside all body members and other cavities. These are the main stages:

1. Degreasing
2. All parts of inaccessible closed sections are coated with zinc primer before welding
3. Phosphating
4. Electrophoretic treatment
5. Priming
6. Sealing all body seams
7. PVC underbody coating
8. A protective coating of PVC on sills and side panels
9. Finishing
10. Before final assembly a

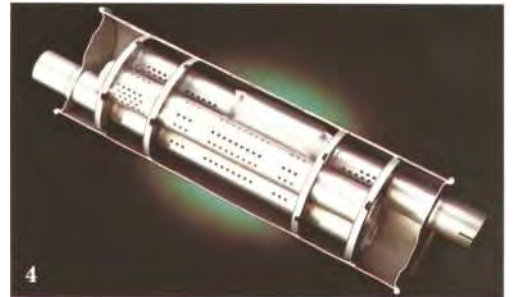
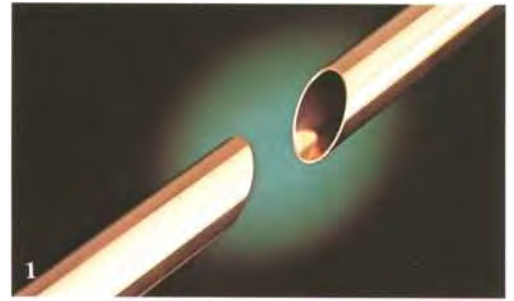

transparent rustproofing agent is liberally sprayed inside the doors and window openings.
11. Full underbody and inner cavity rust-proofing

1. The brake pipes are made of highly corrosion-resistant copper/nickel alloy

2. Slipstream air effectively ventilates inside of door sills.

3. Double-sided hot zinc coated plate is generously used for vulnerable components.

4. Exposed parts of the exhaust system have rust-resisting aluminium finish.

*Based on the findings of the Swedish Motor Vehicle Inspection Co.

Tailor your car to your individual needs

Volvo Accessories-for the Individualist

The Volvo 244 is built to the highest specification standards. But every Volvo owner is an individual with his own particular motoring needs which cannot always be fulfilled even by the exceptionally comprehensive standard equipment of a Volvo. For example, the family man needs child safety equipment, the caravanner needs specialist towing accessories.

This section of our brochure illustrates some of the extensive range of Volvo accessories which enable you to tailor your car to your individual motoring needs.

Accessories for Every Need

All Volvo accessories are manufactured to the same high quality standards as the car. They are designed to complement the style of the car to avoid the 'add-on' look projected by many non-Volvo accessories. And because they are developed by Volvo, fitting has been made as quick and easy as possible.

Ask your Volvo dealer for details of the full range of accessories.



1981 models have special provision for additional instruments to be fitted. Instruments available include the oil pressure gauge, ambient temperature gauge and voltmeter illustrated here.



Volvo Sound

In conjunction with one of the world's leading radio manufacturers, Volvo has developed a comprehensive range of high quality in-car audio equipment. The three-band stereo radio/cassette player, high power 20 watt speakers and power amplifier shown here are just part of the Volvo Sound range.



Child Safety

Cars are designed primarily for adults, but at Volvo we believe that young children too have the right to travel in comfort and safety. The tests shown here, part of a continuous and detailed Volvo child safety research programme, illustrate all too clearly what happens to an unrestrained child in a crash. In a head-on collision at 31 mph a child

weighing 44 lbs will be thrown forward with a force of nearly 2 tons.

From the results of the research programme Volvo has developed a range of child safety equipment unrivalled by any other car manufacturer. The equipment includes a carrycot restraint system and a unique child safety cushion which enables the 6-12 year old to use the standard adult seat belt.





Volvo's space-saving fuel can fits snugly inside the spare wheel. Its capacity is 5 litres.



Volvo's range of Senator seat covers are faced with high quality, foam-backed plush material with nylon velour side and rear panels for easy fitting. Supplied in complete sets for front and rear seats in a choice of colours to complement the interior trim. Matching head restraint cushions are also available in pairs for front and rear.

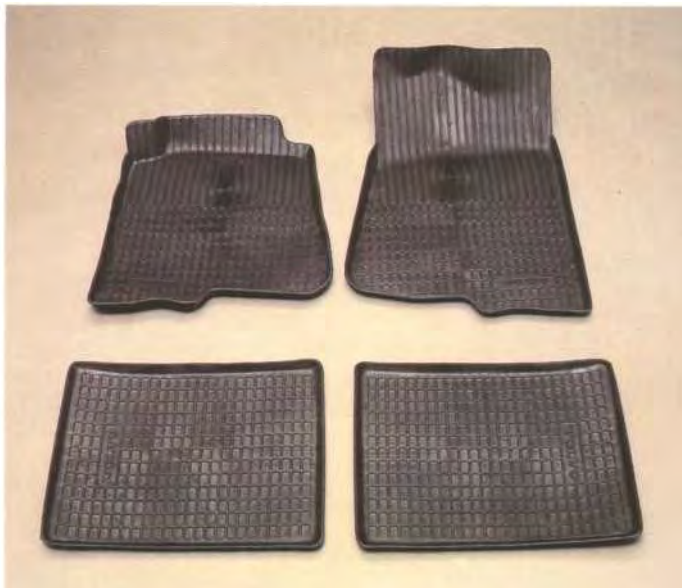

The raised edges of thermoplastic mats prevent dirt and water getting under them and the tailored fit and seined base effectively anchor the mats in place. Supplied in complete sets for front and rear.

Alloy wheels reduce your car's unsprung weight and increase brake cooling. This 25 spoke 'sunburst' design polished aluminium alloy wheel is available with either a small (as illustrated) or large hub cap.



Quick and easy to fit to either wing without drilling the bodywork, the Volvo caravan mirror affords an excellent rear view.



A recent addition to the accessory range are these powerful auxiliary lamps. Two 186mm fog or spot lamps are supplied in complete kits including Halogen bulbs, wiring, switch and fitting brackets.





When towing or carrying a heavy load, a levelling system will maintain the car's normal level, comfort and stability, preventing the headlights from dazzling

on-coming drivers and the car from 'bottoming' on rough roads. Choose between a manual system using a garage air line or a 'finger-tip' system using a

dash-mounted control panel which operates a built-in compressor to inflate or deflate the special rear shock absorbers.



To prevent pilferage or contamination of valuable fuel, fit this strong lockable tank cap. The cap is specially designed so that it will not be dislodged in the event of a crash.



The sturdy tubular steel tow bar will pull a load of 3,300 lbs (1500 kg) as will the alternative 'swing away' version.

Specially designed for the 1981 model, this new roof rack is made from plastic-coated steel tubing and is fitted with quick-release catches. The load area is a practical 40" x 38" and the rack will carry up to 220 lbs.



Self adhesive bumper stripes reflect light at night. Complete set for front (white) and rear (red).



Technical information	244 DL/GL ²	244 GLE	244 GLT
Engine			
Designation	B 21A	B 21E	B 23E
Configuration	In-line 4-cyl	In-line 4-cyl	In-line 4-cyl
Displacement (cc)	2127	2127	2316
Bore/stroke (mm)	92/80	92/80	96/80
Max output, kW DIN at r/s (hp DIN r/min)	79/92 (107/5500)	90/92 (123/5500)	100/92 (136/5500)
Max torque, Nm DIN at r/s (kpm DIN r/min)	170/42 (17.3/2500)	162/58 (16.5/3500)	190/75 (19.4/4500)
Compression ratio/Octane rating	9.3:1/97-98	9.3:1/91-93	10.0:1/97-98
Fuel system	Carburettor	CI system	CI system
Engine block and cylinder head	Cast-iron/light alloy	Cast-iron/light alloy	Cast-iron/light alloy
Valve system	Overhead camshaft	Overhead camshaft	Overhead camshaft
Transmission			
Manual gearbox	4-speed, 4-speed with overdrive ²	4-speed with overdrive	4-speed with overdrive
Automatic	3-stage torque converter	3-stage torque converter	
Cooling system			
Frost-proofed and sealed. Volume (L/pts)	9.5/16.6	9.5/16.6	9.5/16.6
Electrical system			
Battery capacity	12 V/60 Ah	12 V/60 Ah	12 V/60 Ah
Alternator rating	55 A	55 A	55 A
Ignition system	Mech.	Contactless, transist.	Contactless, transist.
Fuel tank			
Volume (litres/galls)	60/13.2	60/13.2	60/13.2
Steering gear			
Rack and pinion steering. Split steering column of safety type. Ratio	21.3:1	21.3:1	17.2:1 Power assisted
Turns of steering, lock to lock	4.3	4.3	3.5
Turning circle diameter (metres/ft)	9.8/32' 2"	9.8/32' 2"	9.8/32' 2"
Suspension			
Front	Spring strut	Spring strut	Spring strut
Rear	Live	Live	Live
Brakes			
Front/rear	Disc/disc	Disc/disc	Disc/disc
Wheels			
Rims	5 J x 14" / 5½ J x 14" ²	5½ J x 14"	6 J x 15"
Tyres	175 SR 14/185/70 SR 14 ²	185/70 SR 14	195/60 HR 15
Weights/Capacity			
Gross laden weight, kg/lb	1780/3921	1780/3921	1780/3921
Permissible trailer weight, kg/lb	1500/3307	1500/3307	1500/3307
Boot capacity cu/ft	21.7	21.7	21.7

Instrumentation and Controls

Padded dashboard. Rheostat-controlled instrument lighting. Six-figure mileometer, tripmeter, fuel gauge and coolant temperature gauge. Warning lamps for alternator charging, oil pressure, choke, main beam, hand brake and brake failure. Tachometer. Bulb integrity sensor. Audible and optical signs for turn indicators. Glove box light. Combined steering wheel lock and ignition switch. Centre console houses controls for electrically heated rear window, headlamp wiper/washers and 4-way hazard warning flashers; seat belt reminder; controls for heating and ventilation; cigar lighter; ashtray; space for radio.

The 244 DL, GL and GLE are suitable for conversion to run on Liquefied Petroleum Gas (LPG) which can offer fuel cost saving benefits as well as the reassurance of a secondary fuel system.

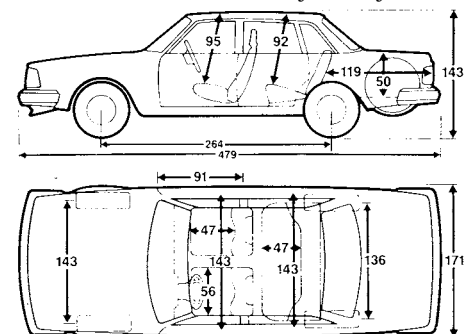

Warranty

12-month unlimited mileage warranty.

The factory reserves the right to make changes at any time, without notice, to prices, colours, materials, equipment, specifications and models and also to discontinue models.

Standard equipment	244 DL	244 GL	244 GLE	244 GLT
Front seats with adjustable lumbar support	●	●	●	●
Electrically heated rear window	●	●	●	●
Head restraints, front	●	●	●	●
Vertical adjustment of driving seat	●	●	●	●
Power assisted brakes	●	●	●	●
Disc brakes all round	●	●	●	●
Bulb integrity sensor (showing if a bulb has failed)	●	●	●	●
Warning lamp for brake circuit failure	●	●	●	●
Reminder lamps for seat belts, front and rear	●	●	●	●
Illuminated ash tray for rear seat	●	●	●	●
Ignition/lights buzzer warning	●	●	●	●
Quartz clock	●	●	●	●
Halogen headlights	●	●	●	●
Day-running lights	●	●	●	●
Automatic reversing lights	●	●	●	●
Inertia reel seat belts front and rear	●	●	●	●
Child-proof rear door latches	●	●	●	●
Fuel tank with safety location	●	●	●	●
Stepped bore brake master cylinder	●	●	●	●
Radial ply, steel belted tyres	●	●	●	●
Storage recesses in doors (front)	●	●	●	●
Intermittent windscreen wipers	●	●	●	●
Headlamp wiper/washers	●	●	●	●
Collapsible steering system	●	●	●	●
Rheostat controlled instrument lighting	●	●	●	●
Laminated windscreen	●	●	●	●
Trip-meter	●	●	●	●
Hazard warning lights	●	●	●	●
Vanity mirror	●	●	●	●
Cigar lighter	●	●	●	●
Mud flaps	●	●	●	●
Full carpeting	●	●	●	●
Day/night rear view mirror	●	●	●	●
Boot/luggage compartment lighting	●	●	●	●
Engine bay light	●	●	●	●
Driver's door mirror, adjustable from inside	●	●	●	●
Energy absorbing bumpers	●	●	●	●
12 month unlimited mileage warranty	●	●	●	●
Side impact protection	●	●	●	●
Tachometer	●	●	●	●
Rear foglights	●	●	●	●
Tinted glass		●	●	●
Metallic paint		●	●	●
Overdrive (on manual gearbox)		●	●	●
Fuel injection			●	●
Leather upholstery			●	
Plush upholstery		●	●	
Cloth upholstery	●			●
Electric front windows			●	
Electrically heated driver's seat	●	●	●	●
Sunroof	option	●	●	●
Front spoiler		●	●	●
Magnesium/alloy wheels				●
Lower profile tyres				●
Power assisted steering				●

All models can be obtained with automatic transmission.
Power assisted steering is available on special order for all DL, GL and GLE models.



VOLVO