

THE NEW VOLVO C30





THERE'S MORE TO LIFE THAN A VOLVO. THAT'S WHY THE NEW VOLVO C30 HAS AS MANY LOOKS AS YOU DO, WHY THERE ARE MORE PERSONALISATION POSSIBILITIES THAN EVER, WHY WE OFFER THE NEW 1.6 DRIVE WITH LOWER EMISSIONS, WHY THIS FOUR-SEATER IS A WORLD BEATER AND WHY YOUR INDIVIDUALITY STILL COULDN'T BE IN A SAFER PLACE. THAT'S WHY YOU DRIVE ONE.

It's different. But that's not the only benefit.

Nature makes sure we all start out unique. And the new Volvo C30 can help you stay that way. First-class comfort, world-class safety and elegant Scandinavian design are all part of the special Volvo DNA and instantly apparent here. At first glance you'll notice unique Volvo design details such as the bigger, bolder iron mark on a larger, trapezoidal grill, aggressive headlamps that sweep back gracefully, yet peer out protectively and demonstrative rear lamps that include state-of-the-art Adaptive Brake Lights that warn cars behind when you brake harder than normal. Add to that exceptional road holding and scores of exterior and interior customisation possibilities, including the sporty R-DESIGN trim, and you'll discover the new Volvo C30 is highly qualified to protect you and yours, especially from boredom.



Volvo safety technology. Because people are only human.

Cars are driven by people. That's why all our safety research and development continues to investigate the capabilities, limitations and tendencies of human nature. This people-centric research is always based on real situations, and with the vision to create cars that do not crash.

To help you avoid accidents while maintaining the fun of driving, Volvo safety technologies are designed to support the driver in various situations without unnecessary interference. All these intelligent technologies share information and interact with split-second precision. Today, a new Volvo can "read" actual situations and provide optimal support and protection for example, by sensing normal driving patterns or panic situations and by taking protective action before, during and after a collision. Still, technology can never take the responsibility away from you, the driver. Final decisions are always in your hands. But if these technologies help make you more alert and relaxed, they will also contribute to the overall safety of those in and around your Volvo.

Read more about our safety research at volvocars.co.uk



“Cars are driven by people. Therefore, the guiding principle behind everything we make at Volvo is – and must remain – safety.”

Assar Gabrielsson and Gustaf Larson, founders of Volvo

Volvo Accident Research Team

Since 1970, Volvo's Accident Research Team has investigated accidents involving Volvo cars on Swedish roads. Today, our own statistical database contains over 36,000 accidents with more than 60,000 occupants. In addition to studies on the scene of the accident, our researchers also investigate what happened before the crash to understand how to improve the driver's conditions to avoid a collision. These findings give us unique knowledge that guides us in creating technology that helps prevent or mitigate accidents and, if an accident can't be avoided, to help protect the occupants.

Volvo Cars Safety Centre

Based on the findings from our accident research, we can recreate a variety of real-life traffic situations and crashes. Beyond numerous virtual crash tests in super-computers, we perform around 400 crash tests each year. We crash test car-to-car at different speeds and from different angles. We perform frontal impacts, rear impacts, side impacts and roll-over tests and test cars off-road as well as against genuine Swedish granite rock-face, we can even simulate impacts with wild animals.

If you make it here, you make it anywhere

Other car manufacturers come to Sweden for final car testing under harsh and capricious conditions. For us it's home. Our own proving ground Hällered with its 34 miles of test tracks includes different road types from all over the world. Here we scrutinise our cars' ability to support their drivers in all imaginable and unimaginable situations during thousands of test kilometres, not to mention the distances driven on ordinary Swedish roads.

Towards a future where cars don't crash

We already know what we want to achieve: no accidents. By applying a holistic approach which considers the driver and the vehicle as well as the infrastructure, we can realise a future where cars interact with other cars, the road and the traffic-control systems. For example, this includes cars that can brake and steer automatically, if needed. This makes it possible to design cars in completely new ways to protect and preserve life.



THERE'S MORE TO LIFE THAN A VOLVO.

For decades, we've created cars that encourage people to enjoy life and help protect it in the event of an accident. Many of the most important car safety innovations are the hallmark of Volvo, and hundreds of thousands of people all over the world can say they're still alive thanks to Volvo ingenuity.

This is not by coincidence. Our founders stated that safety is, and shall always be, at the heart of what we do. As a result, Volvo is recognised the world over for our passion and dedication to provide the safest cars on the road.

The protective character of Volvo also encompasses the world we share. Already in 1972, Volvo was the first car manufacturer to acknowledge and actively respond to the environmental impact of cars. In fact, we invented the three-way catalytic converter, and are constantly innovating to reduce the environmental impact of the cars we make and how we make them.

Of course, choosing a Volvo will always be something you do for both yourself and the people around you, because our cars will always consider the well-being of everyone. Even if those people happen to be outside your car or are part of future generations.

THAT'S WHY WE INNOVATE FOR LIFE.

Find more innovations at volvocars.co.uk

The three-point safety belt

In 1959, Nils Bohlin, a Volvo safety engineer, invented the three-point safety belt. So important is this invention, it is considered to be one of the most life-saving technical innovations in the history of mankind.

The three-way catalytic converter with Lambda sensor

In 1976, Volvo Cars was the first car manufacturer to introduce the three-way catalytic converter with Lambda sensor for exhaust emission control. Today virtually all petrol powered cars are fitted with this ingenious component, just as indispensable for the environment as the three-point safety belt is for safety.

WHIPS (Whiplash Protection System)

In 1998 Volvo introduced this unique front seat integrated technology to help protect occupants from whiplash injury in the event of a low speed rear impact. It's considered one of the most effective systems in the automotive world.

ROPS (Roll-Over Protection System)

This technology including a roll sensor that activates various restraint systems in a roll-over was introduced in 1997 in the Volvo C70 convertible. In 2002 ROPS was further enhanced with the Roll Stability Control (RSC) in the Volvo XC90. ROPS is available in the Volvo C70, XC90 and XC60.

CWAB (Collision Warning with Auto Brake)

In 2006 this radar and camera based technology became available in a Volvo to help alert the driver, and even help mitigate a crash by braking the car, if the distance to the vehicle in front becomes too short. Collision Warning with Auto Brake is available in the Volvo S80, V70, XC70 and XC60.

DAC (Driver Alert Control)

Introduced in 2007, this Volvo innovation can detect erratic driving behaviour due to tiredness or inattentiveness and remind the driver it may be time for a break. Driver Alert Control is available in the Volvo S80, V70, XC70 and XC60.

City Safety collision avoidance technology

In 2008, Volvo Cars introduced the new XC60 with City Safety, the world's first standard-fitted collision avoidance and mitigation technology active at speeds up to 19 mph. Helping to lower the risk of low-speed collisions and whiplash injury, City Safety is a major step towards safer urban driving. At the moment, City Safety is available in the Volvo XC60.



Do the green light proud.

240 Nm of maximum torque makes it easy to believe green is the way to go. Yet, the source of this power, a modified 1.6 litre turbodiesel with technology achieving up to 74.3 mpg* while emitting only 99 grams of CO₂ per kilometre. These numbers help the new Volvo C30 1.6D DRiVe with Start/Stop achieve eco-car status, but it might be the aerodynamic enhancements – from the special tyres, wheels and grill to the roof spoiler and even the under-carriage – that make sure this hyper-efficient automobile is even friendlier to the environment and more fun to drive.

*Based on a combined cycle.

99g CO₂ per km.

Our latest eco-progress, the Volvo C30 1.6D DRIVe with Start/Stop, satisfies itself with up to 74.3 mpg*, for minimum emissions and maximum style.

Green at the red lights.

To further reduce fuel consumption and CO₂ emissions when driving in the city, the 1.6D DRIVe turbo diesel is available with Volvo's new Start/Stop technology.

85% recyclable.

To help minimise its total environmental impact, every Volvo is designed to facilitate recovery and recycling at the end of its useful life.

Maximised fuel efficiency with diesel.

Volvo's advanced common-rail turbodiesel technology ensures superior fuel economy and lower CO₂ emissions, from the 109 PS 1.6D DRIVe with Start/Stop to the 180 PS D5, 74.3-45.6 mpg* and 99-164g CO₂/km.

FSC certified interior wood trim.

Choosing the Nordic Light Oak trim you can be confident that the wood in the interior trim comes from responsibly managed forests and is certified according to Forest Stewardship Council (FSC).

Safer interior materials.

All our upholsteries and interior textiles are tested for certain allergy-inducing or harmful substances and comply with Oeko-Tex Standard 100. And several interior metal details are tested with regard to contact allergies. Good for you, and for anyone who shares your ride.

Fresh cabin air.

Continuously monitoring incoming air and shutting out carbon monoxide, ground-level ozone and nitrogen dioxide.

Eco driving support

Displaying when it's optimum to shift gear, the gear shift indicator in the 1.6D DRIVe variants helps you save fuel and reduce your CO₂ emissions.

Fuel-saving design.

To reduce energy-loss from wind and roll resistance, we utilise advanced aerodynamic design, light-weight materials and low-friction technology. Together with state-of-the-art engine technology, this lowers your CO₂ emissions and helps you travel further on fuel.

Brake for energy.

Driving the 1.6D DRIVe with Start/Stop, the battery is fed with extra power everytime you brake. Smart and fuel-saving.

Cleaner exhaust.

Fast responding after a cold start, Volvo's advanced emission control eliminates between 95 and 99% of carbon monoxide, hydrocarbons and nitrogen oxides from petrol engine exhaust gases. The Volvo turbodiesels feature a particulate filter that removes about 95% of the particles from the diesel exhaust gases.

*Based on a combined cycle.

What's in it for you?

We are committed to creating cars that contribute to a better life, be it inside or outside the vehicle. Utilising advanced technology, your Volvo is designed to use fuel efficiently and reduce its impact on the environment. And nowhere is this more evident than in Volvo's new environmentally optimised DRIVe variants. This caring attitude continues inside your Volvo. Here you and your passengers can experience one of the automotive industry's cleanest and healthiest cabin environments. It's as enjoyable as it's responsible. Just as you would expect of a Volvo.





Because nobody likes pollution but everybody likes to drive.

Thirty years ago the CEO of Volvo said, "Our cars produce pollution, noise and waste." This truth inspired us to do more than just make cars safer to be in. Starting with innovations like the three-way catalytic converter with a Lambda sensor to today's seven new eco-designated DRIVE models, our goal at Volvo is crystal clear: to build cars that leave a minimal impact on the environment. DRIVE captures all our environmental work – from production to recycling – and represents our commitment and continued efforts for sustainable mobility.

Today's DRIVE models are equipped with state-of-the-art diesel engines optimised to reduce fossil fuel-based CO₂ emissions. In addition, some DRIVE models are equipped with Start/Stop technology that allows the engine to switch off when the car is at a standstill – saving even more fuel. Thankfully, the imperative to make our cars more earth-friendly has inspired innovations that make these DRIVE cars even more rewarding to drive.

Our corporate responsibility

At Volvo Cars, our overriding objective is to balance the needs of our company, our customers, society and future generations in a sustainable way. To find out more, please visit www.volvocars.com/sustainability



Motion

We must minimise the emissions of fossil CO₂ (which leads to climate change) and increase the energy efficiency of our cars. **Continuous improvements** within aerodynamics, rolling resistance, lightweight materials and drivetrain technology help us lower fuel consumption. To significantly reduce fossil CO₂ emissions, we offer many **DRIVE turbodiesel** variants with lower CO₂ emissions. We have also introduced **Powershift**, a new fuel-saving dual-clutch automatic transmission technology. In our new **Hybrid technology centre** in Göteborg, we develop the next generation power trains for future Volvos. The goal is that we use hybrid technology in all of our car models.

Inside

We know that more and more people are suffering from asthma and allergies. To ensure a healthy interior for you and your passengers, we test upholstery and interiors in the **Volvo Environmental Laboratory** in Sweden. All upholstery materials and interior textiles also comply with **Oeko-Tex Standard 100**, an international benchmark for human ecological safety of textiles. All **leathers are chromium-free**, they're tanned using vegetable or synthetic substances instead of chromium. And to meet high requirements on an allergy-friendly interior, we've developed the **Clean Zone Interior Package (CZIP)** together with the Swedish Asthma and Allergy Association. What's more, some panel trims are **Forest Stewardship Council (FSC) certified** to ensure the wood comes from responsibly managed forests.

Lifecycle

Already from the early stages of conception we've considered our cars' environmental impact: from design and manufacturing to useful life and recycling. For example, we've seen to it that our factories are powered by electricity produced by wind and hydro power and use energy and water responsibly. Our production facilities are certified under **the global environmental standard ISO 14001**, and we make sure that all our major suppliers meet our strict environmental standards. At the end of its useful life, every Volvo is designed to be **85% recyclable**. We also offer **re-manufactured exchange parts** which substantially reduces the need for raw materials and energy.

Please note: Some of the environmental technologies are only available on certain Volvo models and may be optional. For more information, talk to your Volvo dealer or visit www.volvocars.co.uk



There is nothing normal about these factory settings.

R-DESIGN removes embarrassing sameness with one sweet application. Features factory-installed bodykit, tailgate spoiler, 17" 5-spoke Cratus aluminium wheels, front grille and side mirrors in a special silver matt finish and dual 90 mm tailpipes (with T5 or D5). Inside, superbly comfortable seats with unique upholstery show off an embossed R-DESIGN logo across the front seats. Other exclusive R-DESIGN touches throughout the cabin help define a style that moves beyond the ordinary without fear of being fabulous.

R-DESIGN upholstery

Settle back in unique Off Black or Off Black/Cream leather-faced/T-Tec seats with embossed R-DESIGN logo.

R-DESIGN deco inlay

The centre stack and door handle inlays convey a sporty, contemporary feel.

Sports gear knob

Leather and aluminium are combined to give the gear knob an exciting look and feel.

Sports pedals

Enhance the driving experience with these tough, ridged sports pedals.

Sports steering wheel

Every R-DESIGN model features an exclusive sports steering wheel with embossed logo.

Combi instruments

At the centre of the instrument panel, the speedometer and rev counter feature attractive blue inserts.

Sports floor mats

Look down and you'll see exclusive sports floor mats are brought to life with contrasting piping.

A selection of R-DESIGN items are also available in our Accessory range. Please contact your local dealer for further information.



Be quiet, tomorrow.

Music is life. And Volvo's modern sound systems are among the best in class, especially with the latest generation of Dolby® Pro Logic® II Surround Sound and extremely efficient digital Class D amplification. The Dolby® Pro Logic® II Surround Sound utilises a centre loudspeaker and sophisticated sound processing calibrated especially for the interior of the Volvo C30. This system ensures that every passenger enjoys a well-balanced stereo presence regardless of seating position, a remarkable achievement considering how nobody sits in the middle of the car. Connect your iPod® or USB player and your playlists are easy to select and your music is ready to travel, non-stop.



Dynaudio loudspeakers

The ten high-end loudspeakers by the Danish sound specialist Dynaudio in the Dynaudio Premium Sound audio system are powered by a 5x130 W digital amplifier. There are two separate speakers, woofer and tweeter, in each door, and in the side panels at the rear seats there is a similar set-up. Each speaker has a crossover filter to maximise fidelity. The latest generation Dolby® Pro Logic® II Surround Sound with a centre loudspeaker and sound processor recreates authentic sound with a strong sense of presence for everyone in the car. The digital class D amplifier features new technology that provides extremely high efficiency, enabling it to generate the most audio power from the least amount of current.

Dolby, Pro Logic, and the double-D symbol are registered trademarks of Dolby Laboratories.

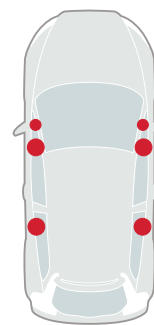

Performance audio system

A console-integrated radio and CD player. It sounds good, looks good and it's easy to use. Performance equipment includes:

- RDS radio
- CD player
- Aux Input in front centre armrest
- 4x20 W amplifier
- 6 loudspeakers

Options: Steering wheel remote audio controls and 6 x CD player* (in place of 1 x CD player) Accessories: USB and iPod® Music Interface.

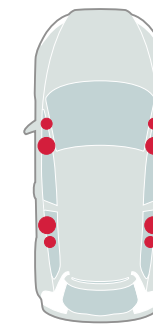

High Performance audio system

A powerfully versatile system. Each loudspeaker is fitted with a more powerful magnet and a larger coil. In combination with the amplifier, this system promotes excellent transient reproduction and high power, quite simply superb sound. High Performance audio system includes:

- RDS radio
- MP3 and WMA compatible CD player
- USB and Aux Input in front centre armrest
- 4x40 W High Performance amplifier
- 8 High Performance loudspeakers

Options: Steering wheel remote audio controls and 6 x CD player* (in place of 1 x CD player) Accessories: USB and iPod® Music Interface.

*This option deletes the USB input

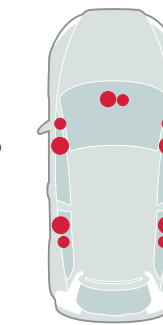

Dynaudio Premium Sound

Our top-of-the line audio system designed for perfect sound dynamics, featuring ten loudspeakers by Dynaudio, a world leader in loudspeaker technology. With Dolby® Pro Logic® II Surround Sound for an authentic audio experience in all seats. Premium Sound equipment includes:

- RDS radio
- MP3 and WMA compatible CD player
- USB and Aux Input in front centre armrest
- 5x130 W digital class D amplifier
- Dolby® Pro Logic® II Surround Sound with centre loudspeaker and digital sound processor
- 10 high-end loudspeakers by Dynaudio

Options: Steering wheel remote audio controls and 6 x CD player* (in place of 1 x CD player) Accessories: USB and iPod® Music Interface.

*This option deletes the USB input



C30 S

The comprehensive standard specification includes ECC (Electronic Climate Control), 16" alloy wheels, DSTC (Dynamic Stability and Traction Control), passenger airbag cut-off switch, power windows, a leather steering wheel and gear knob, floor mats, a CD player and an Aux input for MP3 players.

C30 SE

The SE model brings added luxury. Leksand Textile/T-Tec upholstery, aluminium inlays, cruise control and steering wheel remote controls on the inside are complemented by the 17" Styx White alloy wheels, autofolding power door mirrors with ground lights and fog lights on the outside.

C30 SE LUX

The most luxurious version of the Volvo C30 offers leather upholstery and power drivers seat with memory, whilst 17" Spartacus alloy wheels and active bending lights with headlamp cleaning system identify this model from the outside.

C30 *R*DESIGN

The striking exterior lines are enhanced with 17" Cratus alloy wheels with full bodykit, lowered sports chassis, and logo on the grille. The unique interior design is complemented with embossed Leather/T-Tec upholstery, sports steering wheel and unique aluminium inlay.

C30 *DRIVE*

DRIVE is a series of modifications, adjustments and enhancements designed to make it easy to reduce both your impact on the environment and your running costs. All C30 1.6D DRIVE models produce less than 120 g/km CO₂. The S, SE and SE Lux models can benefit further from Start/Stop technology to produce only 99 g/km CO₂ and fuel consumption up to 74.3 mpg*, which means there is no vehicle excise duty payable.

* Based on a combined cycle

On the road

How much will it cost to get behind the wheel of your own Volvo C30? Simply decide which model variant and engine type are right for you and then take a look at the full price list below.

C30 S

	Basic £	VAT £	Rec Retail Price £	On the Road Price £
PETROL				
1.6 S	£11,952.17	£1,792.83	£13,745.00	£14,495.00
DIESEL				
1.6D DRIVe S	£13,595.65	£2,039.35	£15,635.00	£16,245.00
1.6D DRIVe S with Start/Stop	£14,030.43	£2,104.57	£16,135.00	£16,710.00

C30 SE

	Basic £	VAT £	Rec Retail Price £	On the Road Price £
PETROL				
1.6 SE	£13,473.91	£2,021.09	£15,495.00	£16,245.00
2.0 SE	£14,343.48	£2,151.52	£16,495.00	£17,245.00
DIESEL				
1.6D DRIVe SE	£15,117.39	£2,267.61	£17,385.00	£17,995.00
1.6D DRIVe SE with Start/Stop	£15,552.17	£2,332.83	£17,885.00	£18,460.00
2.0D SE	£15,552.17	£2,332.83	£17,885.00	£18,610.00
D5 SE	£16,856.52	£2,528.48	£19,385.00	£20,110.00

C30 SE LUX

	Basic £	VAT £	Rec Retail Price £	On the Road Price £
PETROL				
2.0 SE Lux	£15,430.43	£2,314.57	£17,745.00	£18,495.00
DIESEL				
1.6D DRIVe SE Lux	£16,204.35	£2,430.65	£18,635.00	£19,245.00
1.6D DRIVe SE Lux with Start/Stop	£16,639.13	£2,495.87	£19,135.00	£19,710.00
2.0D SE Lux	£16,639.13	£2,495.87	£19,135.00	£19,860.00
D5 SE Lux	£17,943.48	£2,691.52	£20,635.00	£21,360.00

C30 R-DESIGN

	Basic £	VAT £	Rec Retail Price £	On the Road Price £
PETROL				
1.6 R-DESIGN	£13,473.91	£2,021.09	£15,495.00	£16,245.00
2.0 R-DESIGN	£14,560.87	£2,184.13	£16,745.00	£17,495.00
T5 R-DESIGN	£16,908.70	£2,536.30	£19,445.00	£20,235.00
DIESEL				
1.6D DRIVe R-DESIGN	£15,334.78	£2,300.22	£17,635.00	£18,245.00
2.0D R-DESIGN	£15,769.57	£2,365.43	£18,135.00	£18,860.00
D5 R-DESIGN	£17,073.91	£2,561.09	£19,635.00	£20,360.00

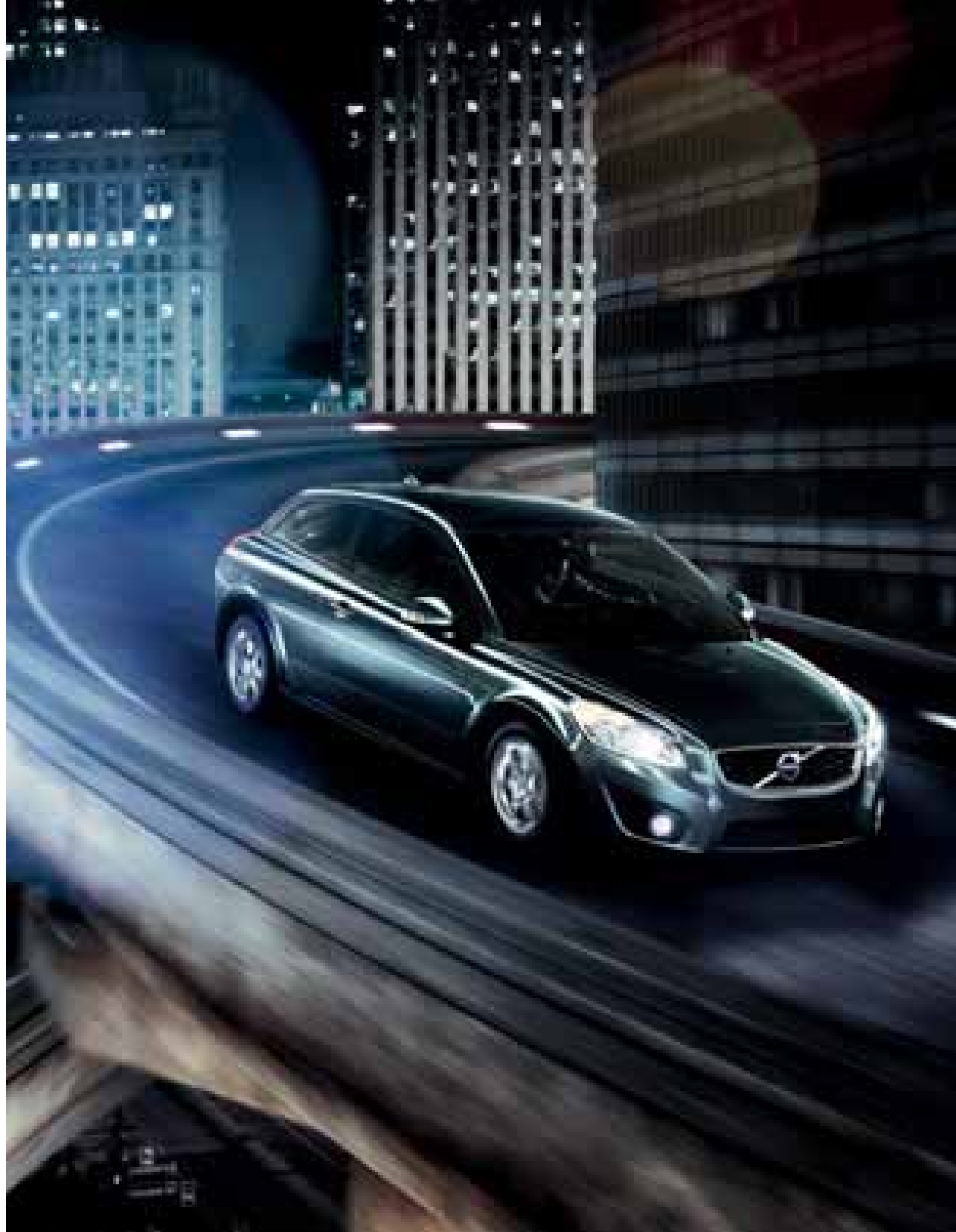

The right equipment

It's essential that your Volvo comes equipped with everything you need. Below you'll find the standard equipment lists for each model variant, plus optional equipment to personalise your Volvo C30. And as you'd expect, there is an array of industry-leading, cutting edge safety innovations.

STANDARD EQUIPMENT - SAFETY & SECURITY	S	SE	SE LUX	REDESIGN
Dual Stage Driver and Passenger Airbags	•	•	•	•
SIPS (Side Impact Protection System)	•	•	•	•
SIPS Airbags	•	•	•	•
IC (Inflatable Curtain)	•	•	•	•
WHIPS (Whiplash Protection System)	•	•	•	•
ABS (Anti-lock Brake System) with EBD (Electronic Brake Distribution) and Electronic Brake Assistance	•	•	•	•
DSTC (Dynamic Stability and Traction Control)	•	•	•	•
4 Three Point Seat Belts	•	•	•	•
Seat Belt Pre-tensioners (Front and Rear)	•	•	•	•
Head Restraints - All 4 Seats	•	•	•	•
ISOFIX Attachment - Rear Seats	•	•	•	•
Anti-theft Alarm including Immobiliser and Level Sensor	•	•	•	•
Key Integrated Remote Control Central Locking including Fuel Flap with Deadlocking System	•	•	•	•
Auto Open/Close Power Windows/and Sunroof (if ordered)	•	•	•	•
Tinted Windows	•	•	•	•
Hard Load Cover	•	•	•	•
Visible VIN Plate	•	•	•	•
Day Running Lights	•	•	•	•
Headlamp Levelling System	•	•	•	•
High Level LED Brake Light	•	•	•	•
Side Marker Illumination	•	•	•	•
Home Safe and Approach Lighting	•	•	•	•
IDIS (Intelligent Driver Information System)	•	•	•	•
Passenger Airbag Cut Off Switch	•	•	•	•

STANDARD EQUIPMENT - EXTERIOR	S	SE	SE LUX	REDESIGN
16" Convectur Alloy Wheels (Silver Stone) - 205/55 R16 W Tyres	•			
16" Libra Alloy Wheels (Diamond Cut) - 205/55 R16 V Energy Saving Tyres (1.6D DRIVE only)	•			
17" Styx White Alloy Wheels - 205/50 R17 W Tyres		•		
17" Spartacus Alloy Wheels (Silver Bright) - 205/50 R17 W Tyres			•	
17" Cratus Alloy Wheels (Silver Bright Matt) - 205/50 R17 W Tyres				•
Locking Wheel Nuts	•	•	•	•
Tyre Sealant Kit and Compressor	•	•	•	•
Active Bending Lights with Headlamp Cleaning System		•	•	•
Power Adjustable and Heated Door Mirrors	•	•	•	•
Autofolding Power Door Mirrors with Ground Lights		•	•	•
Front Fog Lights		•	•	•
Black Painted Lower Sill and Wheel Arch Mouldings		•	•	•
Colour Coordinated Door Mirrors	•	•	•	•
REDESIGN Silver Matt Door Mirrors				•
REDESIGN Silver Matt Grille with Logo				•
Rain Sensor - Automatic Windscreen Wiper Activation		•	•	•
Dynamic Chassis	•	•	•	•
DRIVE Lowered Chassis (1.6D DRIVE only)	•	•	•	•
Lowered Sports Chassis (Not 1.6)				•
Rear Spoiler (D5, T5, 1.6D DRIVE REDESIGN, 1.6D DRIVE with Start/Stop)	•	•	•	•
REDESIGN Full Bodykit (Front and Rear Spoilers, Side Skirts, Body Colour Wheel Arch Mouldings and Unique Tail Pipe)				•

STANDARD EQUIPMENT - INTERIOR	S	SE	SE LUX	REDESIGN
ECC (Electronic Climate Control) and Pollen Filter	•	•	•	•
Information Centre	•	•	•	•
Exterior Temperature Gauge	•	•	•	•
Cruise Control		•	•	•
Front Power Windows	•	•	•	•
Illuminated Driver and Passenger Vanity Mirrors	•	•	•	•
Front Reading Lights	•	•	•	•
Autodimming Rear View Mirror with Humidity Sensor		•	•	•
Front and Rear Centre Armrest	•	•	•	•
Front Storage Box with Removable Cupholders	•	•	•	•
Bottle Holder		•	•	•
Front and Rear 12V Socket	•	•	•	•
Power Driver's Seat with Seat Memory			•	•
Height Adjustable Passenger Seat with Lumbar Support		•	•	•
Folding Rear Seats	•	•	•	•
Leather Steering Wheel, Gear Knob and Handbrake Lever	•	•	•	•
REDESIGN Leather Sports Steering Wheel with Aluminium Inserts and Logo				•
REDESIGN Sports Gear Knob with Aluminium Inserts and Leather Handbrake Lever				•
Height and Reach Adjustable Steering Column	•	•	•	•
REDESIGN Blue Instrument Dials				•
REDESIGN Aluminium Sports Pedals				•
Bauxite Trim	•			•
Aluminium Trim		•	•	•
REDESIGN Deco Aluminium Trim				•
Falsterbo Upholstery	•			•
Leksand Textile/T-Tec Upholstery		•		•
Leather-faced Upholstery			•	•
REDESIGN Leather/T-Tec Upholstery with Logo				•
Floor Mats	•	•	•	•
REDESIGN Sports Floor Mats with Contrasting Piping				•
Performance Sound Audio System - 1 x CD/Radio, 4 x 20W Amplifier and 6 Speakers	•	•	•	•
Aux Input for MP3 Player	•	•	•	•
Steering Wheel Remote Audio Controls		•	•	•



OPTIONAL EQUIPMENT – SAFETY & SECURITY	Basic £	VAT £	Rec Retail Price £	S	SE	SE LUX	REDESIGN
BLIS (Blind Spot Information System) with Autofolding Power	£565.22	£84.78	£650.00	o	u (£450)	u (£450)	o
Door Mirrors and Ground Lights	£260.87	£39.13	£300.00	o	o	o	o
Laminated Side Windows	–	–	–	nco	nco	nco	nco
Soft Load Cover	–	–	–	nco	nco	nco	nco

OPTIONAL EQUIPMENT – EXTERIOR	Basic £	VAT £	Rec Retail Price £	S	SE	SE LUX	REDESIGN
Black Paint (Solid)	£217.39	£32.61	£250.00	o	o	o	n/a
Metallic/Pearlescent Paint	£456.52	£68.48	£525.00	o	o	o	o
Inscription™ Paint	£652.17	£97.83	£750.00	o	o	o	o
Contrast Coloured Lower Sill and Wheel Arch Mouldings	£152.17	£22.83	£175.00	n/a	o	o	n/a
16" Libra Alloy Wheels (Diamond Cut) – 205/55 R16 V Energy Saving Tyres (1.6D DRIVE only)	–	–	–	●	nco	nco	n/a
17" Styx White Alloy Wheels – 205/50 R17 W Tyres	£434.78	£65.22	£500.00	o	●	nco	n/a
17" Zaurak Alloy Wheels (Silver Bright) – 205/55 R16 W Tyres	£434.78	£65.22	£500.00	o	nco	nco	n/a
17" Spartacus Alloy Wheels (Silver Bright) – 205/50 R17 W Tyres	£434.78	£65.22	£500.00	o	n/a	●	n/a
18" Atreus Alloy Wheels (Diamond Cut/Dark Grey) – 215/45 R18 W Tyres (Not 1.6 or 1.6D DRIVE) ⁽ⁱ⁾	£434.78	£65.22	£500.00	n/a	n/a	n/a	o
18" Midir Alloy Wheels (Diamond Cut/Light Grey) – 215/45 R18 W Tyres (Not 1.6 or 1.6D DRIVE) ⁽ⁱ⁾	£434.78	£65.22	£500.00	n/a	n/a	n/a	o
Tempa Spare Wheel and Jack Kit	–	–	–	nco	nco	nco	nco
Front Fog Lights	£173.91	£26.09	£200.00	o	●	●	●
Autofolding Power Door Mirrors with Ground Lights	£173.91	£26.09	£200.00	o	●	●	o
Rear Park Assist	£304.35	£45.65	£350.00	o	o	o	o
Lowered Sports Chassis (Not 1.6, 1.6D DRIVE SE and SE Lux or with 18" Alloys)	£347.83	£52.17	£400.00	n/a	o	o	●



OPTIONAL EQUIPMENT – INTERIOR	Basic £	VAT £	Rec Retail Price £	S	SE	SE LUX	REDESIGN
Powershift (6 Speed Automatic Transmission) (2.0D only)	£1,217.39	£182.61	£1,400.00	n/a	o	o	o
Geartronic Transmission (T5 and D5 only)	£1,130.43	£169.57	£1,300.00	n/a	o	o	o
Keyless Drive	£304.35	£45.65	£350.00	o	o	o	o
Power Glass Tilt and Slide Sunroof	£608.70	£91.30	£700.00	o	o	o	o
Power Driver's Seat with Seat Memory	£478.26	£71.74	£550.00	o	o	●	o
Height Adjustable Passenger Seat with Lumbar Support	£86.96	£13.04	£100.00	o	●	●	o
Heated Front Seats	£217.39	£32.61	£250.00	o	o	o	o
Aluminium Trim	£217.39	£32.61	£250.00	o	●	●	n/a
Oyster Burst Trim	£217.39	£32.61	£250.00	o	nco	nco	n/a
Leksand Textile/T-Tec Upholstery	–	–	–	n/a	●	nco	n/a
Leather-faced Upholstery	£1,043.48	£156.52	£1,200.00	o	u (£600)	●	n/a
Steering Wheel Remote Audio Controls	£65.22	£9.78	£75.00	o	●	●	●
6 x CD Player ⁽ⁱⁱⁱ⁾	£65.22	£9.78	£75.00	o	o	o	o
High Performance Sound Audio System – 1 x CD/Radio, 4 x 40W Amplifier, USB and Aux Input and 8 Speakers (MP3/WMA Compatible)	£347.83	£52.17	£400.00	o	o	o	o
Dynaudio Premium Sound Audio System – with Dolby Pro Logic II Surround Sound ^(iv) , 5 x 130W Amplifier, USB and Aux Input, 1 x CD and 10 Speakers (MP3/WMA Compatible)	£1,000.00	£150.00	£1,150.00	o	o	o	o
Satellite Navigation System (RTI) with RDS-TMC and Map Data on Hard Disk ^(v)	£1,391.30	£208.70	£1,600.00	o	o	o	o
Bluetooth® Handsfree System ^(vi)	£217.39	£32.61	£250.00	o	o	o	o
Dual Band Integrated GSM Telephone and Volvo On Call ^(vi)	£434.78	£65.22	£500.00	o	o	o	o

WINTER PACK	Basic £	VAT £	Rec Retail Price £	S	SE	SE LUX	REDESIGN
Heated Front Seats and Headlamp Cleaning System	£304.35	£45.65	£350.00	o	o	n/a	o
Winter Pack with Active Bending Lights	£804.35	£120.65	£925.00	o	o	n/a	o
COMMUNICATIONS PACK							
Satellite Navigation System (RTI) with RDS-TMC ⁽ⁱⁱ⁾ , Remote Control and Map Data on Hard Disk, Keyless Drive and Bluetooth® Handsfree System ^(vi)	£1,608.70	£241.30	£1,850.00	o	o	o	o
CONVENIENCE PACK							
Autodimming Rear View Mirror with Humidity Sensor, Rain Sensor and Bottle Holder	£239.13	£35.87	£275.00	n/a	n/a	n/a	o

● = standard, o = option, n/a = not available, nco = no cost option, u (£) = upgrade, ® = Registered Trademark.
(i) Cannot be combined with Lowered Sports Chassis on 2.0D and 2.0P. Dynamic Chassis becomes standard.
(ii) Must be ordered in conjunction with High Performance or Dynaudio Premium Sound Audio Systems.
(iii) If a 6 x CD Player is ordered, standard USB port is removed from the audio system.
(iv) Dolby and Pro Logic Surround™ are trademarks of Dolby Laboratories Licensing Corporation.
(v) Aux Input is removed when Bluetooth® Handsfree System is ordered in conjunction with Performance Sound Audio System.
(vi) Volvo On Call includes Safety package (Security package available at additional cost).

Inside information

Here you can learn more about the features and technology of your Volvo C30. Some are standard, some are optional. For more detailed information, please contact your Volvo dealer or visit www.volvocars.co.uk

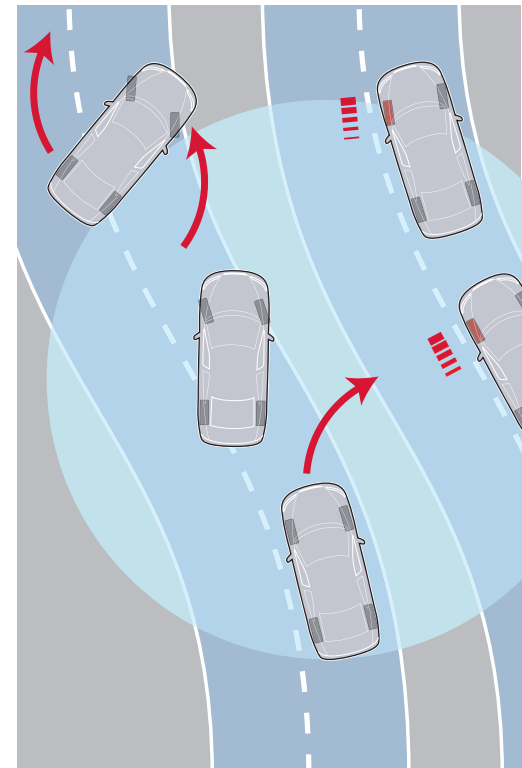

Dynamic Stability and Traction Control (DSTC)

Dynamic Stability and Traction Control, DSTC, enhances driving stability and helps you maintain traction in a wide range of situations. At the core of DSTC, a gyroscope senses the car's direction and compares this with steering wheel movements as well as the actual rotation of the car's wheels. DSTC is able to detect a potential skid and help counteract one by reducing the engine's power output, or braking on one or more wheels.

Whiplash Protection System (WHIPS)

Integrated in the front seats, Volvo's WHIPS cradles the occupant to help reduce the risk of whiplash injury (one of the most common types of traffic injury and often the result of a low-speed rear impact collision). The function is activated by a collision of sufficient force from behind. Independent research has shown that WHIPS is one of the most effective systems in the world and can reduce the risk of long-term invalidity by 50%.



Active Bending Lights (ABL)

Compared to conventional halogen headlamps, Active Bending Lights use Dual Xenon technology to expand your vision range by about 230%. This means you'll be helped to gain 45 metres more for braking. And using motorised lamps that turn up to 15° in either direction, this technology gives a 90% boost to your vision round bends at night. You can enjoy highly effective low beam illumination on narrow, winding roads and extremely powerful full beams on the motorway. A daylight sensor disengages the adaptive function during daytime to extend its lifespan. Independent of the load, these headlights self-adjust to maintain the correct angle to the road – even during hard acceleration or braking.

IC (Inflatable Curtain)

The Inflatable Curtain (IC) helps protect the heads of both front and rear outboard occupants. It also stays inflated for some seconds to provide prolonged protection for subsequent impacts.



ISOFIX

ISOFIX attachments only allow you to fit the child seat in the correct way. They also make the child seat easier to fit and remove. We offer two rearfacing child seats with ISOFIX attachments: one for infants and small children up to 13 kg, and one for children weighing between 9 and 18 kg.



Side Impact Protection System (SIPS)

SIPS is a Volvo unique safety system that has been developed to help protect where occupants are most exposed to the crash forces. The steel framework of the car – including the front seats – is designed and reinforced to help displace the impact of a side-collision away from the occupants to other parts of the car body and help prevent intrusion into the cabin. The side structure is extremely strong to help withstand a severe side impact – even with a larger vehicle. The Inflatable Curtain (IC) for all the occupants and the front seat side airbags interact to help provide further protection.



Dual-stage airbags, driver and front passenger

Helping to optimise protection, the dual-stage airbags adapt the level of inflation depending on the force of the collision. The driver's airbag also interacts with the deformation of the collapsible steering column.



Road and Traffic Information (RTI)

Volvo's GPS-based RTI navigation system offers both voice guidance and graphic navigation all the way to your destination. Via TMC (Traffic Message Channel) radio data broadcasts, RTI also lets you know if there's weather-related trouble on route and recommends an alternative. Extremely swift and precise, this new generation RTI features a hard disc drive covering maps for major parts of Europe. The system is fully integrated in your Volvo and is easily controlled from the steering wheel or optional remote, and the screen is positioned so you can keep your attention on traffic. You can choose between two operating modes – Easy and Advanced. When RTI is not needed, the screen is hidden into the dash. To help you keep track of new roads and points of interest, you can join our MapCare programme for two free map updates.

Load cover, hard

This load cover keeps cargo out of sight. It also provides a shelf where you can put light objects such as gloves and hats. To access your load, simply open up the convenient hatch. And when the load cover's not needed, it's easy to remove.



Integrated Bluetooth® handsfree system

Bluetooth® technology enables a mobile phone to be connected to the infotainment system in your Volvo, wirelessly. Once configured for a mobile phone, the system automatically recognises your phone as you enter the car. And as you climb in and out of the car, the system automatically allows you to switch freely from the phone to the handsfree system and back again. With Volvo's integrated Bluetooth® handsfree system you conveniently operate your phone using the buttons in the steering wheel or the centre console keypad. Available as an accessory, there's also a voice-controlled Bluetooth® handsfree system that will listen to your command and make calls for you.

The Bluetooth word mark and logos are owned by the Bluetooth SIG, Inc. and any use of such marks by Volvo Car Corporation is under license. Other trademarks and trade names are those of their respective owners.

Keyless Drive

Keep the car key in your pocket or handbag. Using the keyless drive technology you can unlock the doors and drive away without using the car key. To start the engine, just turn the starter control in the instrument panel.



Autofolding Power Door Mirror with Ground Lights

At the touch of a button, these door mirrors can be folded flat against the car where they are less likely to get damaged after you've parked. They also fold or unfold automatically every time you lock or unlock the car. The integrated ground lighting is activated with the remote control. Beyond enhancing security to and from your car at night, this is also convenient when getting in and out.

Park assist

Activated when you engage reverse gear, rear park assist helps you when reversing into tight spaces. The audio system is turned down and a pulsating sound from the rear loudspeakers becomes a continuous tone as you approach an obstacle.

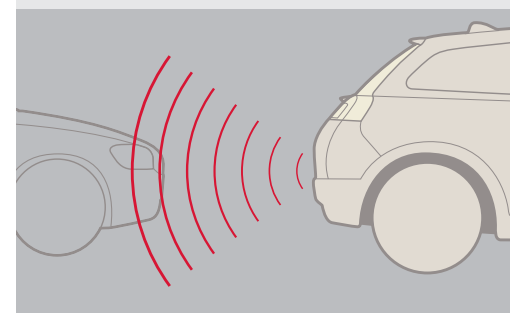

Accessories from Volvo

Of course, your New Volvo C30 won't be perfect until it's exactly how you want it. So here's a selection of our range of accessories to completely personalise your new car.



Floating centre console
Add your own personality by choosing from a range of specially designed centre consoles.

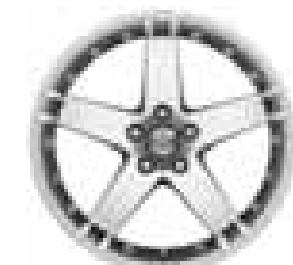

18" Medea Split
Silver Bright



17" Freja
Diamond Cut/Light Grey

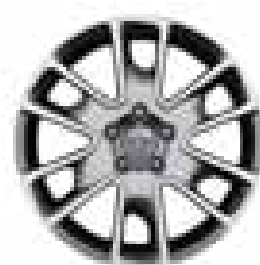

17" Freja
Diamond Cut/Dark Grey Matt



USB and iPod® music interface
Simply connect your iPod® or USB device and seamlessly integrate with your Volvo's audio system.



"Space design" roof box
A lightweight, aerodynamic roof box available in two sizes: 380 and 480 litres.



Towbars
Our lockable, easy-to-remove towbars are designed specifically for your Volvo.

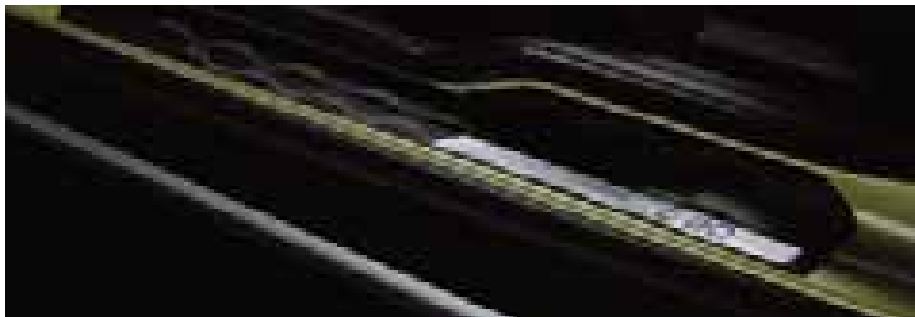

Sill protection
Add extra protection to the sill with this stylish sill deco, featuring the same pattern as the front grille.



Towbar-mounted bike rack
This state-of-the-art holder secures your bicycles conveniently and safely on the back of your Volvo.



Portable navigation system
Designed to complement your Volvo, this easy-to-use Garmin nüvi® navigation unit guides you all the way.



Infant seat (up to 13 kg)
Infants can travel safely backwards in this comfortable, easy-to-carry seat with five-point harness.



Cargo floor mats
Equipped with a high-friction coating, these mats stop dirt and water seeping into the cargo compartment.



Styling
Enhance the youthful, sporty feel of your Volvo C30 with this exclusive exterior styling kit.

Take a look at all our accessories and full pricing information, at www.volvocars.co.uk/accessories

COLOUR YOUR VOLVO. When it comes to the appearance of your Volvo, the choice of exterior colour and wheels are probably your most important design decisions. For more exterior styling options and to build your new Volvo online, please visit www.volvocars.co.uk

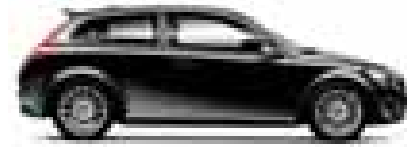

019 Black Stone

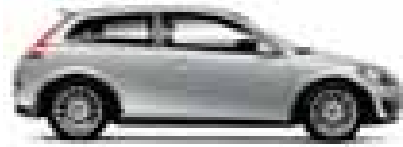

426 Silver metallic

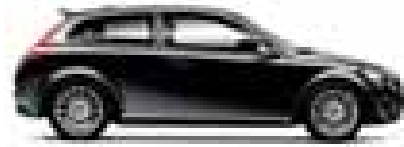

452 Black Sapphire metallic⁰

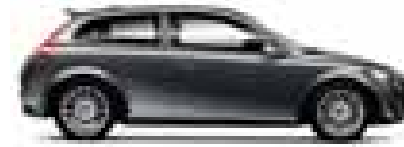

455 Titanium Grey pearl⁰



466 Barents Blue pearl

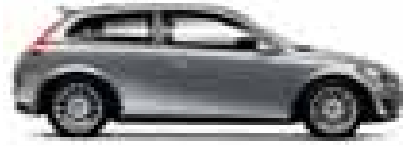

477 Inscription™ Electric Silver coarse flake metallic⁰
(sparkling metallic, shifts from silver to blue effect depending on light)

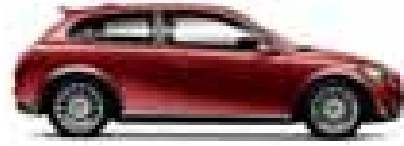

478 Maple Red pearl

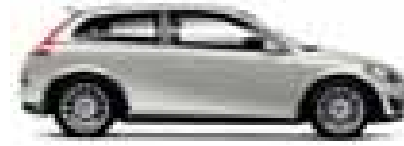

481 Cosmic White metallic⁰



490 Chameleon Blue pearl
(shifts from blue to gold or transparent effect depending on light)



495 Lime Grass Green metallic⁰



612 Passion Red⁰

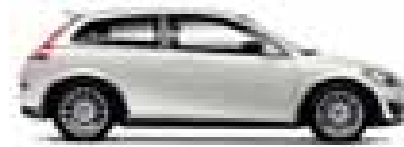

614 Ice White⁰

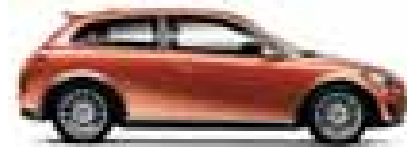

701 Orange Flame metallic⁰

⁰ Also available for R-design.

Please note: It's not possible to reproduce exact original shades in printed matter. Please ask your dealer to show you samples.

Clean colours

To reduce usage of environmentally hazardous solvents all Volvo exterior colours are water-based. What's more, our painting facilities are among the cleanest in the world.

EXTERIOR DESIGN Aluminium wheels



18" Atrius
Diamond Cut/Dark Grey



18" Midir
Diamond Cut/Light Grey



17" Cratus
Silver Bright Matt



17" Spartacus
Silver Bright



17" Styx
White



17" Zaurak
Silver Bright



16" Convector
Silver Stone



16" Libra
Diamond Cut/Light grey

EXTERIOR DESIGN Contrast Colour Collection

The design of the new Volvo C30 features lower body panels that enhance the appearance of the wheels at the car's corners and while making the wheels look bigger. The C30 S comes with black plastic lower body panel but when you choose the SE or SE LUX trim levels, many more dramatic possibilities are available. The contrast colour collection, shown here, offers some combinations suggested by our designers. To see more possibilities, mix and match your colour choices online at www.volvocars.com



426 Silver metallic
The C30 S with black plastic lower body panels.



426 Silver metallic
The C30 SE/SE LUX with 442 Java metallic lower body panels in matt finish.



426 Silver metallic
The C30 SE/SE LUX with 455 Titanium Grey metallic lower body panels in matt finish.



426 Silver metallic
The C30 SE/SE LUX with 452 Black Sapphire metallic lower body panels in matt finish.
Equipped with Exterior Styling Pack.

Lower body panels	452 Black Sapphire metallic	442 Java metallic	463 Blackcurrant metallic	480 Shadow Blue metallic	455 Titanium Grey metallic
701 Orange Flame metallic	●		○		
478 Maple Red metallic	●		○		
614 Ice White	●	●	●	○	●
426 Silver metallic	●	●	○	●	●
477 Inscription™ Electric Silver coarse flake metallic	●	●	●	○	●
481 Cosmic White metallic	●	○	●	●	●
490 Chameleon Blue metallic	●			○	
495 Lime Grass Green metallic	●	○			
612 Passion Red	○				
466 Barents Blue metallic	○				
019 Black Stone	●	●		○	
452 Black Sapphire metallic	●	○		●	
455 Titanium Grey metallic	●		○		●

● = Available combination ○ = Designers choice



426 Silver metallic
The C30 SE/SE LUX with 452 Black Sapphire metallic lower body panels in matt finish.



426 Silver metallic
The C30 SE/SE LUX with 480 Shadow Blue metallic lower body panels in matt finish.



426 Silver metallic
The C30 SE/SE LUX with 463 Blackcurrant metallic lower body panels in matt finish.

IMAGINE YOUR NEW INTERIOR. Crafted according to your requirements, the interior of your Volvo can take on any number of personalities. Choose between three interior colours – Offblack, Offblack/Blond, Espresso/Blond – and different upholstery variants. Pick the interior that suits you and add the finishing touch with the interior trim, steering wheel, gear knob and floor mat of your choice. After all, you're probably going to spend a lot of time here.

ERGONOMIC DESIGN Developed in cooperation with ergonomic specialists to provide generous support for the body during hours of driving, the seats in the Volvo C30 are among the most comfortable in the automotive world. Multiple adjustment possibilities and adjustable lumbar support make it easy to find the perfect driving position.



Leather

This is the upholstery that affords the Volvo C30 an atmosphere of luxury. It's a new hide quality that's smooth, durable and has a fine grain pattern. Like all Volvo leather, it's organically tanned and ages beautifully.

Leksand

Contemporary textile upholstery trimmed with ultra-modern T-Tec, inspired by wetsuits and durable outdoor gear. The ribbed backrest and contrasting seams add further zest.

Falsterbo

Textile upholstery with contrasting piping, reflecting the sporty yet relaxed elegance of the Volvo C30.

INTERIOR DESIGN



Leather steering wheel



R-DESIGN Leather sports steering wheel with aluminium inlay

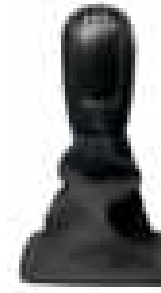

Leather gear knob, manual



Leather gear knob, Geartronic



R-DESIGN Leather gear knob with aluminium inlay, manual



R-DESIGN Leather gear knob with aluminium inlay, Geartronic



Bauxite centre stack and door panel inlays



Aluminium centre stack and door panel inlays

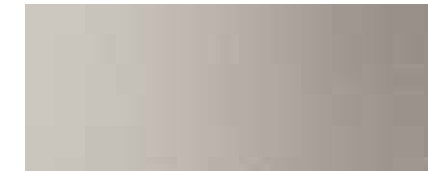

Oyster Burst centre stack and door panel inlays

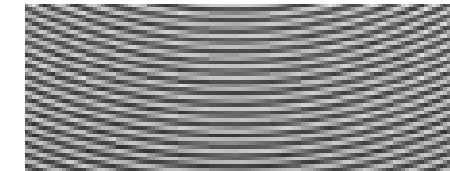

R-DESIGN centre stack and door panel inlays

Upholstery	Upholstery code	Interior colour	Upholstery colour	Dashboard top & upper door panel	Lower door panel, lower dashboard & tunnel console	Floor mats	Door insert colour
R-DESIGN Leather/T-Tec with Logo	5FS7	Off Black	Off Black	Off Black	Off Black	Off Black	Off Black
	5FSK	Off Black	Off Black/Cream	Off Black	Off Black	Off Black	Calcite
Leather-faced	5DSM	Off Black	Cranberry	Off Black	Off Black	Off Black	Cranberry
	5DNM	Off Black/Blond	Cranberry	Off Black	Blond	Off Black	Cranberry
	5DQP	Espresso/Blond	Blond	Espresso	Blond	Espresso	Blond
	5DSH	Off Black	Off Black	Off Black	Off Black	Off Black	Off Black
	5DSP	Off Black	Blond	Off Black	Off Black	Off Black	Blond
5DBH	Off Black	Off Black	Off Black	Off Black	Off Black	Red	Off Black
Leksand textile/T-Tec	5HBH	Off Black	Off Black	Off Black	Off Black	Red	Off Black
	5HS3	Off Black	Off Black/Spring Green	Off Black	Off Black	Off Black	Off Black
	5HSV	Off Black	Off Black/Sunburst Orange	Off Black	Off Black	Off Black	Off Black
	5HNN	Off Black/Blond	Off Black/Blond	Off Black	Blond	Off Black	Blond
	5HQ3	Espresso/Blond	Blond/Spring Green	Espresso	Blond	Espresso	Blond
5HQV	Espresso/Blond	Blond/Sunburst Orange	Espresso	Blond	Espresso	Blond	
Falsterbo textile	57SL	Off Black	Off Black	Off Black	Off Black	Off Black	Off Black
	57SP	Off Black	Blond	Off Black	Off Black	Off Black	Blond
	57SA	Off Black	Surf Blue	Off Black	Off Black	Off Black	Surf Blue

The roof lining is always in Quartz and the steering wheel in Off Black

INTERIOR DESIGN Leather-faced



Off Black interior
Leather-faced Off Black, 5DSH
Off Black carpeting and floor mats



Off Black interior
Leather-faced Cranberry, 5DSM
Off Black carpeting and floor mats



Off Black interior
Leather-faced Blond, 5DSP
Off Black carpeting and floor mats

INTERIOR DESIGN Leksand



Off Black interior
Leksand Off Black, 5HBH
Red carpeting and floor mats



Off Black interior
Leksand Off Black/Spring Green, 5HS3
Off Black carpeting and floor mats



Off Black interior
Leksand Off Black/Sunburst Orange, 5HSV
Off Black carpeting and floor mats



Off Black interior
Leather-faced Off Black, 5DBH
Red carpeting and floor mats



Off Black/Blond interior
Leather-faced Cranberry, 5DNM
Off Black carpeting and floor mats



Espresso/Blond interior
Leather-faced Blond, 5DQP
Espresso carpeting and floor mats



Off Black/Blond interior
Leksand Off Black/Blond, 5HNN
Off Black carpeting and floor mats



Espresso/Blond interior
Leksand Blond/Spring Green, 5HQ3
Espresso carpeting and floor mats



Espresso/Blond interior
Leksand Blond/Sunburst Orange, 5HQV
Espresso carpeting and floor mats

INTERIOR DESIGN Falsterbo



Off Black interior
Falsterbo Off Black, 57SL
Off Black carpeting and floor mats



Off Black interior
Falsterbo Blond, 57SP
Off Black carpeting and floor mats



Off Black interior
Falsterbo Surf Blue, 57SA
Off Black carpeting and floor mats

INTERIOR DESIGN R-DESIGN



Off Black interior
R-DESIGN Off Black, 5FS7
R-DESIGN centre stack and door panel inserts
Off Black carpeting and R-DESIGN floor mats



Off Black interior
R-DESIGN Off Black/Cream, 5FSK
R-DESIGN centre stack and door panel inserts
Off Black carpeting and R-DESIGN floor mats



Off Black textile mats

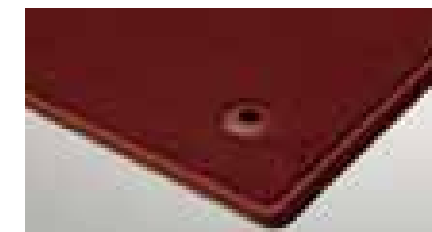

Red textile mats



Espresso textile mats

Improvise.

Modern physics suggests a certain amount of fundamental randomness in the universe, which makes the versatile new Volvo C30 perfect for impromptu shopping. Like every Volvo, this car is built to provide an intelligent mix of performance and practicality. For example, the seating and storage configurations are flexible enough to provide 876 litres of loading capacity as well as a flat cargo space almost 150 cm long. Of course, roof-mounted carrying accessories are also available and, if you're really serious about shopping, a tow bar might be an option.



Buckle up.

Settle in to one of the world's most comfortable driver's seats and you'll find everything you need close at hand. The unique floating centre console presents intuitive controls for the infotainment and climate systems and is available in a variety of finishes including the Hagstrom guitar inspired Oyster Burst. The overall effect is stimulating, yet the elegant simplicity of pure Scandinavian design also invites you to relax, while wearing the stylish 3-point safety belt Volvo invented for you, of course.





Lean back.

The seats in your new Volvo C30 are an extremely comfortable example of ergonomic excellence. In fact, year after year Volvo seats are said to be the most comfortable in the automobile industry. Part of that comfort, we believe, comes from riding in one of the safest cars on the road. In this car, with four seats, no one rides the hump. The back seats, set closer together for a better view forward, have a VIP lounge feeling with a centre armrest, tilted backrests and convenient amenities such as side storage and a clever table that is the flip-side of the front-centre armrest.

In fine detail

The nuts and bolts of your Volvo C30. Whatever you need to know about your new car – whether that's fuel consumption, CO₂ emissions, top speed or boot space – you'll find it here.

ENGINE	1.6 Man	2.0 Man	T5	1.6D DRIVe Man	2.0D	D5
Configuration	Transverse – 16 valve	Transverse – 16 valve	Transverse – 20 valve	Transverse – 16 valve	Transverse – 16 valve	Transverse – 20 valve
Cylinders	4	4	5	4	4	5
Engine capacity, cc	1596	1999	2521	1560	1997	2400
Bore x stroke, mm	79 x 81.4	87.5 x 83.1	83 x 93.2	75 x 88.3	85 x 88	81 x 93.2
Max. output ECE, PS/kw/rpm	100/74/6000	145/107/6000	230/169/5000	109/80/4000	136/100/4000	180/132/4000
Max. torque ECE, Nm/rpm	150/4000	185/4500	320/1500 – 5000	240/1750	320/2000	400/2000 – 2750
Octane rating	95 RON Unleaded	95 RON Unleaded	98 RON ⁽ⁱ⁾ Unleaded	N/A Diesel	N/A Diesel	N/A Diesel
Fuel system	Multipoint fuel injection	Multipoint fuel injection	Multipoint fuel injection	Multipoint direct fuel injection	Multipoint direct fuel injection	Multipoint direct fuel injection
Compression ratio	11.0:1	10.8:1	9.0:1	18.3:1	18.5:1	17.3:1

PERFORMANCE	1.6 Man	2.0 Man	T5		1.6D DRIVe Man	2.0D		D5	
			Man	Gt	Man	Man	P/shift	Man	Gt
Top speed (mph)	115	130	149	146	118	127	127	140	137
Acceleration 0-60mph, sec	11.2	8.8	6.2	6.6	10.7	8.8	9.0	7.3	7.8
Acceleration 0-62mph (0-100kmh), sec	11.8	9.4	6.7	7.1	11.3	9.4	9.5	7.7	8.4
Drag co-efficient	0.31	0.31	0.31		0.28	0.31		0.31	

FUEL CONSUMPTION ⁽ⁱⁱ⁾⁽ⁱⁱⁱ⁾	1.6 Man	2.0 Man	T5		1.6D DRIVe		2.0D		D5	
			Man	Gt	S/S Man	Man	Man	P/shift	Man	Gt
Urban mpg (l/100km)	30.4 (9.3)	27.7 (10.2)	22.4 (12.6)	20.9 (13.5)	61.4 (4.6)	49.6 (5.7)	37.2 (7.6)	37.2 (7.6)	34.0 (8.3)	29.7 (9.5)
Extra Urban mpg (l/100km)	49.6 (5.7)	48.7 (5.8)	44.1 (6.4)	43.5 (6.5)	85.6 (3.3)	74.3 (3.8)	61.4 (4.6)	57.6 (4.9)	56.5 (5.0)	52.3 (5.4)
Combined mpg (l/100km)	40.4 (7.0)	38.2 (7.4)	32.5 (8.7)	31.4 (9.0)	74.3 (3.8)	62.8 (4.5)	49.6 (5.7)	47.9 (5.9)	45.6 (6.2)	40.9 (6.9)
CO ₂ g/km	167	177	203	211	99	119	151	156	164	182
VED (Vehicle Excise Duty) Band	H	I	K	K	A	C	G	G	G	I
Fuel tank volume, litres	55	55	62	62	52	52	52	52	60	60
Emissions Level	Euro IV	Euro V	Euro V		Euro IV		Euro IV		Euro IV	

NB All diesel models are fitted with a Diesel Particulate Filter, except 2.0D Manual

INSURANCE GROUPS	1.6 Man	2.0 Man	T5	1.6D DRIVe Man	2.0D	D5
S	TBC	-	-	TBC	-	-
SE	TBC	TBC	-	TBC	TBC	TBC
SE Lux	-	TBC	-	TBC	TBC	TBC
R-DESIGN	TBC	TBC	TBC	TBC	TBC	TBC

E = Exceeds security requirements for model concerned and group rating has been reduced.

WEIGHTS	1.6 Man	2.0 Man	T5		1.6D DRIVe		2.0D		D5	
			Man	Gt	S/S Man	Man	Man	P/shift	Man	Gt
Min. kerb weight, kg (actual kerb weight dependent on spec.)	1286	1344	1437	1448	1370	1365	1430	1454	1479	1495
Max. possible towing weight braked, kg	1200	1350	1500	1500	N/A	1300	1500	1500	1500	1500
Max. towing weight unbraked approx, kg ^(v)	600	650	700	700	N/A	650	700	700	700	700
Max. towball weight, kg	75	75	75	75	N/A	75	75	75	75	75
Max. total weight, kg	1700	1750	1860	1860	1780	1780	1840	1840	1900	1900
Max. roofload, kg	75	75	75	75	75	75	75	75	75	75
Max. payload, kg (dependent on spec.)	414	406	423	412	410	415	410	386	421	405

LUGGAGE COMPARTMENT	All models		POWER STEERING SYSTEM		
Volume, litres	433		16"	17"	18"
Volume, rear seats down, litres	947		(rack & pinion)	10.6 (34.9)	10.6 (34.9)
			Turning circle, m (ft)	11.6 (38.1)	11.6 (38.1)

BRAKES	1.6/2.0/1.6D/1.6D DRIVe/2.0D	T5/D5
Disc diameter front, mm	15" – 278 Ventilated	16" – 300 Ventilated
Disc diameter rear, mm	280	280

TRANSMISSION	
Manual 2.0D/T5/D5	6 speed
Manual 1.6/2.0/1.6D/1.6D DRIVe	5 speed
Geartronic T5/D5	5 speed
Powershift (Automatic Gearbox) (2.0D)	6 speed

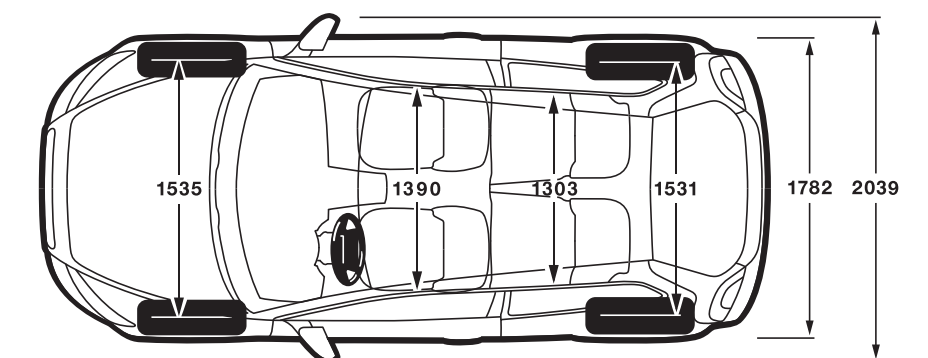
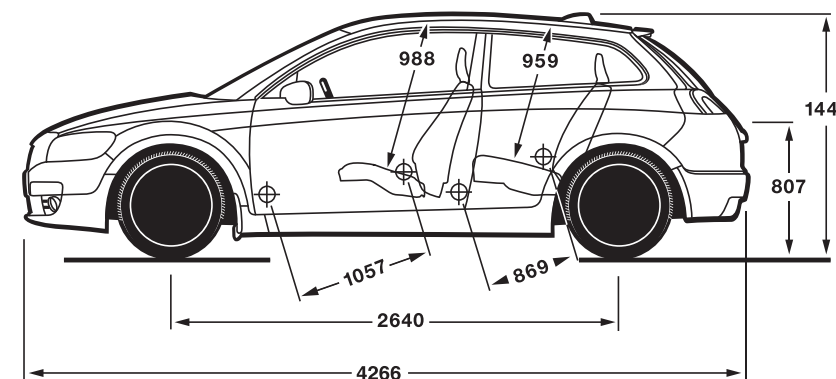

- (i) For best performance and lowest fuel consumption 98 RON is recommended, 95 RON can be used for normal driving.
- (ii) The results do not express or imply any guarantee of the fuel consumption of a particular car.
- (iii) Official fuel consumption figures are obtained in accordance with Directive 93/116/EC as amended by 1999/100/EC. The figures are obtained under controlled test conditions and as such consumption achieved on the road will not necessarily accord with the official test results. Factors including driving styles and road, car and weather conditions will also have a bearing on actual fuel consumption achieved.

- (iv) CO₂ and fuel consumption is based on petrol operation.
- (v) Unbraked towing weight must not exceed 50% of kerb weight up to a maximum of 700 kg.

Notes
The weight of the vehicle will influence the level of CO₂ emitted and as a result, vehicles with higher levels of specification and factory fit options may emit higher levels of CO₂. However, Vehicle Excise Duty is charged according to the weight and CO₂ emissions of the standard vehicle, as published in this price list. The weight effect of any additional items does not affect the amount of Vehicle Excise Duty payable.

A weighbridge must be used to determine specific weights. Data valid for manual transmission unless specified.

All measurements in mm.

Gt = Geartronic Automatic Transmission.

P/shift = Powershift Automatic.

S/S = Start/Stop technology.

The Max. output figures are quoted in PS (Pferdestärke), which is the metric equivalent of brake horsepower.

NB Some of the information in this price list may not be correct due to product changes which may have occurred since it was printed. Some of the equipment described or shown may now be available only at extra cost. Before ordering, please ask your Volvo dealer for the latest information. The manufacturer reserves the right to make changes at any time, without notice, to prices, colour, materials, specifications and models.

Volvo Car UK Limited, Globe Park, Marlow, Buckinghamshire, SL7 1YQ.

Meet the family.

Fuel consumption and CO₂ emissions for the Volvo range:

Fuel consumption mpg (l/100 km):
Urban: 57.7 (4.9) – 14.1 (20.0).
Extra Urban: 83.1 (3.4) – 28.8 (9.8).
Combined: 74.3 (3.8) – 20.9 (13.5).
CO₂ emissions: 99 – 322g/km.

Please note: Some of the information in this brochure may be incorrect due to changes in product specification that may have occurred since printing. Some of the equipment described or shown may now only be available at extra cost. Before ordering, please ask your Volvo dealer for the latest information. The manufacturer reserves the right to make changes at any time and without notice, to prices, colours, materials, specifications and models.

Furthermore: There are options, accessories and packages that can be chosen separately or combined as you like. For more information, please contact your Volvo dealer.

S



Volvo S40 The compact and energetic saloon.



Volvo S80 The premier saloon, meticulously engineered for superior driving comfort.

V



Volvo V50 The Sportswagon – flexible, compact and full of zest.



Volvo V70 The genuine family estate – highly competitive yet comfortably versatile.

XC



Volvo XC60 A sporty coupe and a capable all-roader fused into a Swedish crossover experience.



Volvo XC70 The rugged yet stylish all-roader.



Volvo XC90 The versatile SUV that takes you anywhere with grace.

C



The new Volvo C30 The compact and charismatic SportsCoupe.



The new Volvo C70 A retractable hardtop convertible that seats four adults with comfort.

The end is just the beginning

VOLVO TOTAL CARE

We want your experience of buying and owning a Volvo to be one of life's pleasures, that's why we're here to make it as care-free and easy as possible. It's simple – Volvo Total Care is a single port of call for all your motoring requirements, from funding your purchase to protecting your investment with Volvo Car Insurance to monthly payment plans for servicing. We will even provide you with special offers during your ownership. Volvo Total Care is designed to make owning a Volvo rewarding. For further information on Volvo Total Care please contact your dealer or go to www.volvocars.co.uk/totalcare

FINANCE

As part of Volvo, Volvo Car Finance has developed a series of funding plans that will provide you with maximum choice and flexibility when acquiring a Volvo[®]. For details of the current promotions available, please visit www.volvocars.co.uk/financepromotions

WHAT NEXT? If you'd like to find out more about the range of products and services that make up Care by Volvo, the story continues at www.volvocars.co.uk. Alternatively you can contact your nearest Volvo dealer or request relevant brochures.

(i) Finance subject to status. Guarantees/indemnities may be required. Volvo Car Finance SL7 1YQ.

(ii) When using a Volvo approved Body and Paint repairer.

(iii) Volvo Car Insurance is underwritten by Royal & Sun Alliance Insurance plc (No. 93792). Registered in England and Wales at St Mark's Court, Chart Way, Horsham, West Sussex RH12 1XL. Authorised and regulated by the Financial Services Authority. For your protection telephone calls will be recorded and may be monitored. All benefits are subject to qualifying status, terms and conditions, cover level and underwriting criteria. Service and repair benefits are subject to being carried out by a recommended repairer.

INSURANCE

Volvo Car Insurance is designed for Volvo drivers and because we know Volvos inside out, we can offer exactly the right tools and expertise, fitting only genuine Volvo parts by trained Volvo technicians[®]. Your Volvo will come with seven days drive away insurance, so you've already got peace of mind. Because Volvo drivers have an excellent reputation, we can also offer extensive cover at a reasonable price[®].

Call now for your insurance quote on **0800 238 239**, quoting reference BROCH.

SERVICING YOUR VOLVO

Your Volvo dealer has the unique know-how to tailor a service programme according to Volvo's strict recommendations and guarantees you years of safety and driving pleasure. In addition, why not save yourself money on service costs by taking out a Volvo Service Plan? They're designed to spread servicing costs on an interest-free monthly basis, providing you with economic, convenient servicing and peace of mind.

Whatever option you choose your costs are fixed no matter what happens to labour, parts or oil prices. You will also have the satisfaction of being able to have your Volvo serviced at any one of our UK Volvo dealers and Service Centres. For further information and to purchase online please go to www.volvocars.co.uk/serviceplan

VOLVO ON CALL

Subscribe to Volvo On Call and you'll never be completely on your own. It's a GPS-based communication system providing 24-hour access to both emergency and roadside assistance wherever you are. See the Volvo On Call brochure for more information.

LOOKING AHEAD

You'll probably never find out just how good some of these services are. But should the unexpected happen, we'd like to think that you'd be even happier you chose a Volvo.

ROADSIDE ASSISTANCE

Every new car comes with one year's Volvo Assistance cover. You'll enjoy free breakdown and recovery assistance, anywhere in Europe, 24 hours a day. You can even extend cover for £85 for one year or £155 for two years. Call Volvo Assistance on **08701 650 978**.

WARRANTY

Every new Volvo comes with comprehensive protection. Our warranty covers the first three years or 60,000 miles, whichever comes first. There's a three year unlimited mileage warranty on the paintwork, and either eight or twelve years against rust perforation. If a component fails due to a defect or material fault, your dealer will swiftly rectify the problem, free of charge.

THERE'S MORE TO LIFE THAN A VOLVO.

Volvo. for life



THAT'S WHY YOU DRIVE ONE.

VOLVO

Volvo Car UK Limited
www.volvocars.co.uk

All "On The Road" prices quoted in this price list include Volvo standard national delivery charge, inclusive of number plates and VAT at £520 and the VED (Vehicle Excise Duty) car tax as of 1st May 2009. This charge does not include any provision for fuel. The "On The Road" price also includes a \$55 vehicle first registration fee (as set by the government – excludes Channel Islands and Isle of Man). Recommended retail prices quoted do not include these additions.

MODEL YEAR 2010.5 EDITION 1
Issued 05/10/2009