



Commercial
Vehicles

The Amarok



Build your own

Find a Van Centre

Test drive

Offers & Finance

Conversions

Comparator

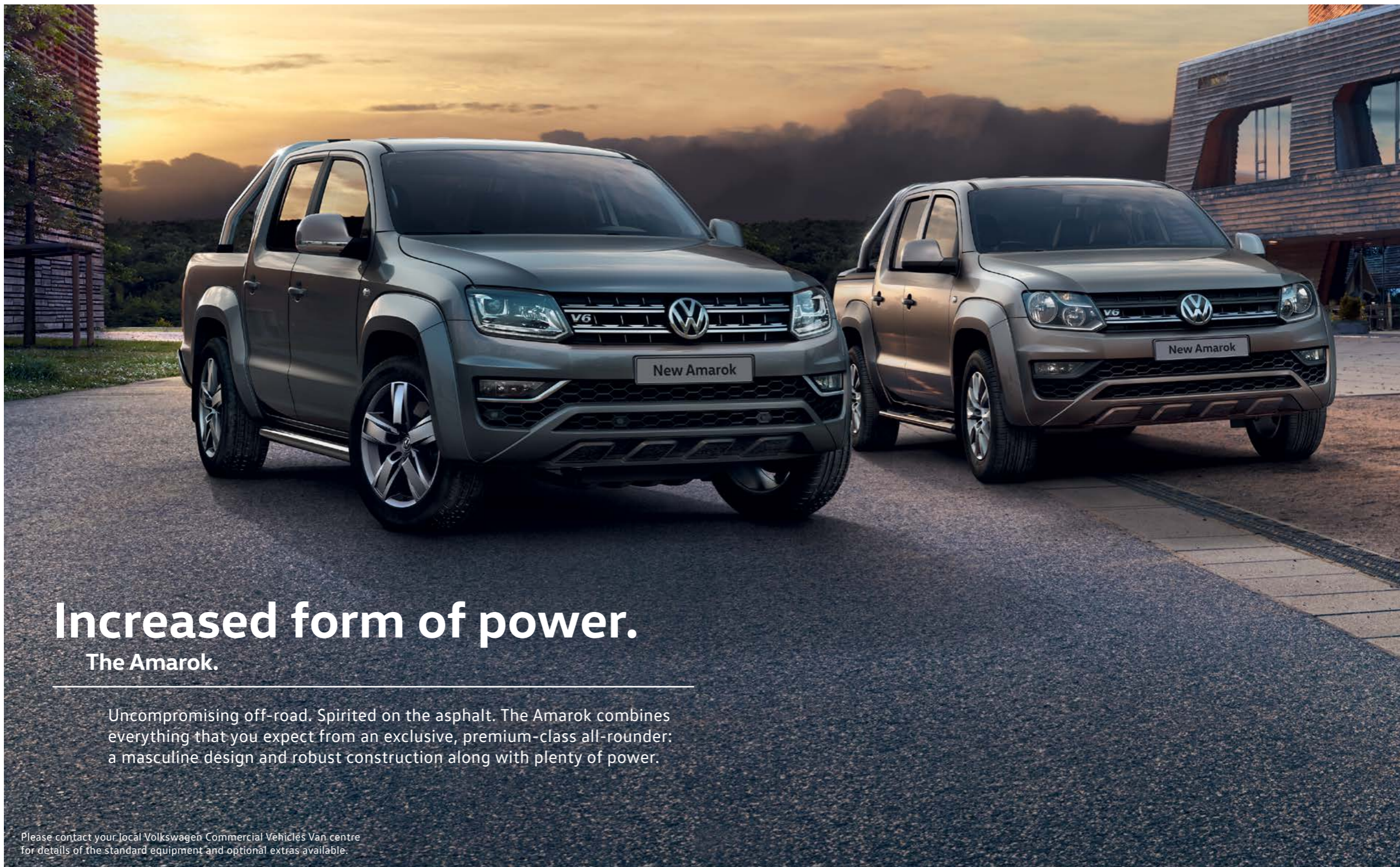

Increased form of power.

The Amarok.

Uncompromising off-road. Spirited on the asphalt. The Amarok combines everything that you expect from an exclusive, premium-class all-rounder: a masculine design and robust construction along with plenty of power.

Please contact your local Volkswagen Commercial Vehicles Van centre for details of the standard equipment and optional extras available.

The Amarok.

100% pickup. 100% premium.

V6

Perfect for off-road.

4MOTION all-wheel drive with two distinct, innovative systems; Selectable and Permanent.

Optimised safety.

Automatic Post-Collision Braking System utilising 17" disc brakes in the front and 16" disc brakes at rear.

Load platform surface usage.

Widest load platform in its class and moving tailgate.

Towing capacity and payload.

Towing load of up to 3.1 tonnes and 1,146kg payload.¹

Exterior design.

Styling bar plus² and up to 19" alloy wheels.³

Interior design.

Intuitive controls and the only vehicle with 'ergoComfort' seats with 14-way adjustment.³

Modern infotainment systems.

Radio and navigation systems with Car-Net mobile online services.

V6 3.0 litre TDI engines.

With a power output of up to 224PS and torque of up to 550 Nm.

Unique drive combinations.

Selectable 4MOTION all-wheel drive with 6-speed manual gearbox. Permanent 4MOTION all-wheel drive with 8-speed automatic gearbox.

Fuel-saving technology.

Including start/stop system.

- 1 Amarok Trendline 3.0 litre V6 TDI 204PS engine, Permanent 4MOTION all-wheel drive with 8-speed automatic transmission.
- 2 Optional at extra cost.
- 3 Optional on Amarok Highline models.

Please contact your local Volkswagen Commercial Vehicles Van centre for details of the standard equipment and optional extras available.



Contents.

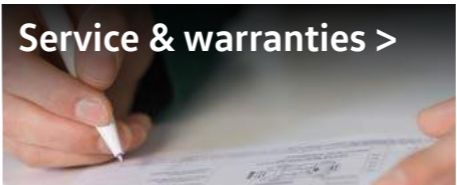
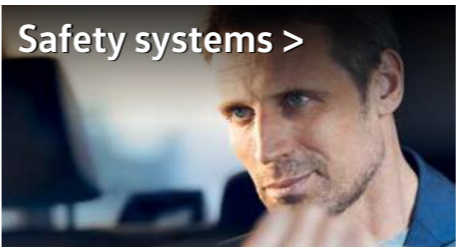
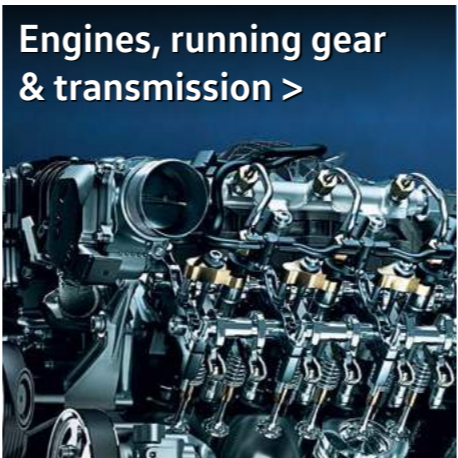
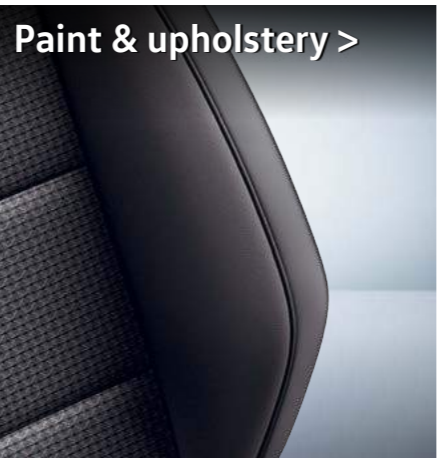
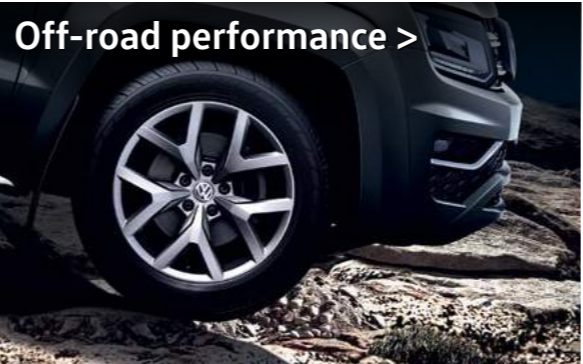

More dynamic.

Clear lines and bi-xenon headlights.

The Amarok is eye-catching from any angle, with its wide stance and rugged appearance combined with powerful engines, strong chassis and superb interior styling. The chiselled contours and styling highlights exude quality and style, beautifully complemented by the striking rear design, making it as much at home for the family as it is at work.



Please contact your local Volkswagen Commercial Vehicles Van centre for details of the standard equipment and optional extras available.



With the sporty leather trimmed **multifunction steering wheel with paddles**¹ you have the entire vehicle in your grasp – while the **multifunction display plus** helps you to keep an eye on everything. The **servotronic power steering** also improves steering response and creates a dynamic driving experience.

¹ Available as an option. Please contact your local Volkswagen Commercial Vehicles Van centre for details of the standard equipment and optional extras available.

More exclusive.

Stylish cockpit with premium equipment, intuitive infotainment systems and Car-Net mobile online services.

The interior provides a convincing combination of space, high comfort and numerous extras. All Amarok models feature as standard, a dash panel with decorative trim, A4 format storage compartment and a leather trimmed multifunction steering wheel. Depending on your choice of model, the Amarok also includes either the Composition Media DAB+ radio system or the Discover Media navigation system.



'App-Connect' is available in conjunction with the Composition Media radio system or the Discover Media navigation systems. 'App-Connect' comprises MirrorLink™, CarPlay™ and Android Auto™. The availability of these technologies may vary depending on the country in question. Please note that 'App-Connect' is not currently supported by every mobile telephone on the market. Volkswagen is working closely with major smartphone producers to promote broader compatibility for 'App-Connect'.



Please contact your local Volkswagen Commercial Vehicles Van centre for details of the standard equipment and optional extras available.

More reassuring.

Equipped with the Automatic Post-Collision Braking System and electronic trailer stabilisation system as standard.

Safety on almost any terrain: The Amarok is the only pick-up in its class to come with an Automatic Post-Collision Braking System as standard. What's more, the Amarok also features 17" brake discs at the front and 16" brake discs in the rear. Add to that, the trailer stabilisation system which provides the best possible protection against snaking trailers, and it all provides even further peace of mind.

For more information please refer to the Infotainment, driver assistance and safety systems section.



More powerful.

With its 3.0 litre V6 TDI engine, the Amarok is the only pickup in its class with an 8-speed automatic gearbox.

Powerful like no other, the 204PS six-cylinder turbo diesel engine with 3.0 litre capacity has more than enough power reserves even in the most demanding situations. Should you opt for the V6 224PS TDI engine, not only do you get additional output, this engine also features an overboost function which briefly increases its performance up to an impressive 245PS, depending on the driving situation.

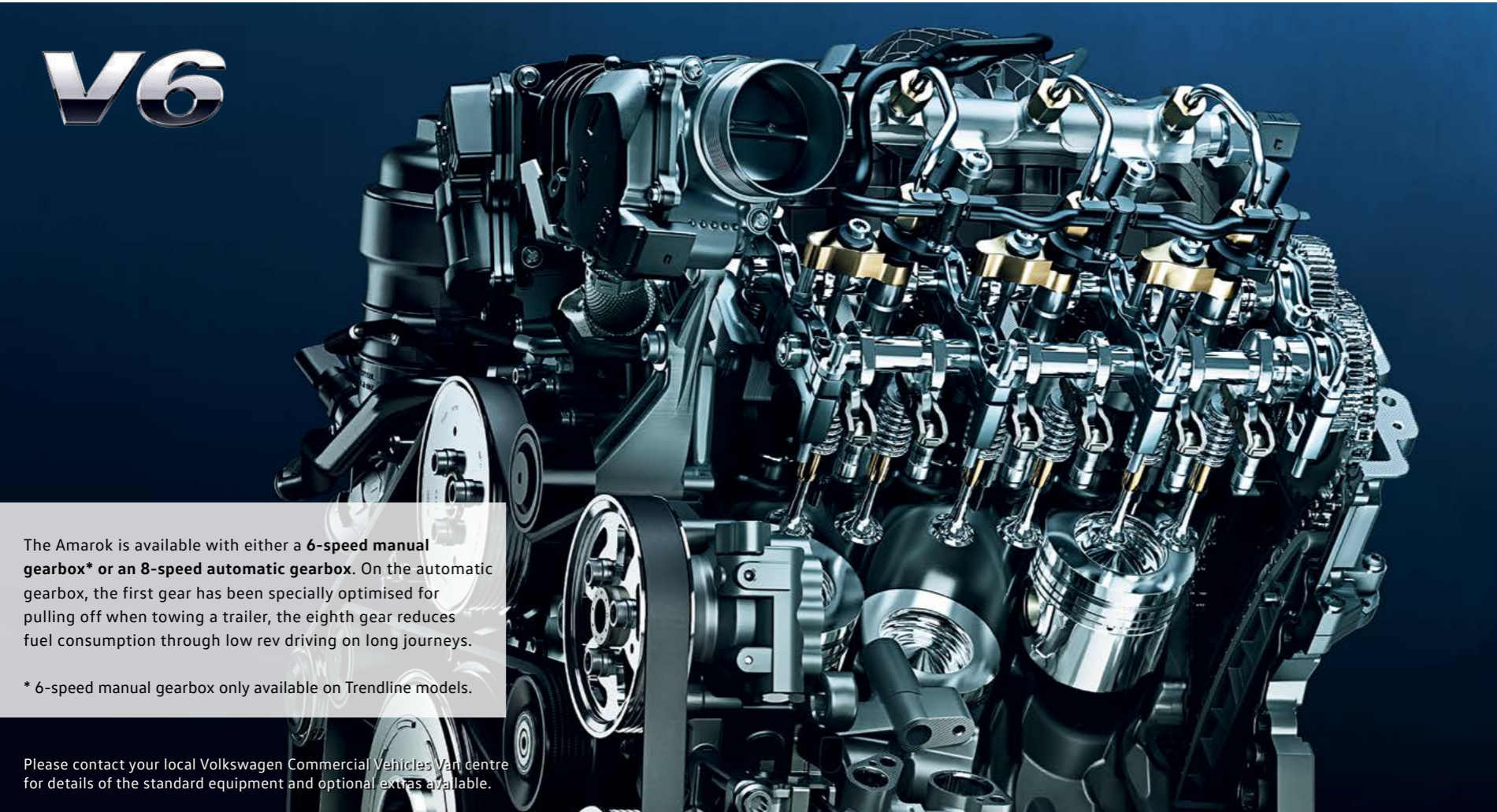

3.0 litre TDI 224PS engine with 8-speed automatic gearbox and 550 Nm of torque and overboost function up to 245PS.

Combined cycle fuel consumption: 34.9 mpg
CO₂ emissions: 212 g/km

3.0 litre TDI 204PS engine with 6-speed manual gearbox and 500 Nm of torque.

Combined cycle fuel consumption: 32.5 mpg
CO₂ emissions: 229 g/km

3.0 litre TDI 204PS engine with 8-speed automatic gearbox and 500 Nm of torque.

Combined cycle fuel consumption: 34.9 mpg
CO₂ emissions: 212 g/km

3.0 litre TDI 163PS engine with 6-speed manual gearbox and 450 Nm of torque.

Combined cycle fuel consumption: 32.5 mpg
CO₂ emissions: 228 g/km

The Amarok is available with either a **6-speed manual gearbox*** or an **8-speed automatic gearbox**. On the automatic gearbox, the first gear has been specially optimised for pulling off when towing a trailer, the eighth gear reduces fuel consumption through low rev driving on long journeys.

* 6-speed manual gearbox only available on Trendline models.

Please contact your local Volkswagen Commercial Vehicles Van centre for details of the standard equipment and optional extras available.

More powerful.

4MOTION all-wheel drive, off-road ABS and Hill Descent Assist.

The Amarok offers premium driving comfort, even under the toughest of conditions. This is due to the perfect harmony created between the running gear and drive train – combined with the proven and tested 4MOTION all-wheel drive which knows how to pack a punch when it needs to. The outstanding off-road ABS function also helps to reduce braking distances on loose terrain.



The Amarok is the only pickup in its class to offer drivers the **luxury of combining the Permanent 4MOTION all-wheel drive with an 8-speed automatic gearbox.** The automatic gear-change system increases driving comfort considerably, particularly on challenging terrain or in hilly regions.

Selectable 4MOTION all-wheel drive with a 6-speed manual gearbox, is also available on Trendline models and proves its strength through the open terrain.

Please contact your local Volkswagen Commercial Vehicles Van centre for details of the standard equipment and optional extras available.



Off-road performance.

Ready for the challenge.

The Amarok's innovative Selectable and Permanent 4MOTION all-wheel drive systems enable sure-footed progress when you encounter rain, snow, sand, mud or gravel. They're designed to maintain traction while off-road, as well as offering improved road holding and increased safety in poor surface conditions.



01

01 Selectable 4MOTION all-wheel drive. This allows you to switch between high and low gear ranges and rear or all-wheel drive. In all-wheel drive mode, power is distributed evenly between the front and rear axles to ensure the best possible traction.

Permanent 4MOTION all-wheel drive (not shown). This 4x4 drive system with a self-locking Torsen central differential is unique in the pickup segment and provides a balanced 40:60 distribution for all on-road and off-road tasks.¹ This vehicle also comes into its own on the road by significantly increasing traction when cornering.

Mechanical differential lock (not shown). The Amarok is also available with an optional mechanical differential lock which helps provide ideal traction on sandy and slippery terrain. Following activation, both of the rear wheels are powered with even power and even speed.

Hill Hold Assist (not shown). This prevents the vehicle from rolling back on inclines and simplifies hill starts.

¹ The distribution varies depending on the surface.

Please contact your local Volkswagen Commercial Vehicles Van centre for details of the standard equipment and optional extras available.



02



04



03



05

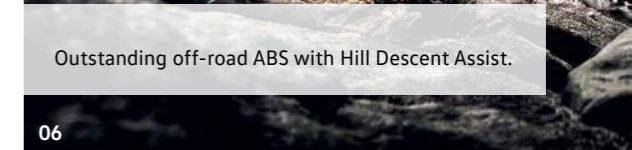

06

02 Brakeover angle. Thanks to increased ground clearance and depending on the loading condition, the Amarok can climb ramps with an angle from 15.6° up to 20.1°. ¹

04 Ramp angle and wading depth. The maximum angles of approach and departure for the Amarok is 29.5° at the front and 18.0° at the rear. It also has a wading depth of 500mm.

03 Gradients. The Amarok handles inclines up to 45°. ¹

05 Traverse gradient. The broad wheelbase of the Amarok provides enormous stability even when traversing slopes with a 50° incline. ^{1,2}

06 Off-road ABS. Once activated, the wheels lock when braking on loose surfaces with a larger interval, essentially digging the tyres into the surface creating a wedge which significantly reduces the braking distance. This noticeably increases the driving safety.

06 Hill Descent Assist. Allows you to drive down slopes in a safe, controlled way, thanks to the engine management's ability to govern the engine speed, and apply the brakes when driving off-road if necessary. The vehicle's speed is maintained at a constant crawling pace.

1 The values vary depending on the equipment and engine.
 2 The incline on the left side is 49.7° and 50.8° on the right side.

Please note: these figures result from static calculations. The illustrations on these pages can only be regarded as a general guide. Please contact your local Volkswagen Commercial Vehicles Van centre for details of the standard equipment and optional extras available.

More robust.

Sturdy ladder frame design and an impressive towing capacity of up to 3.1 tonnes.

Exceptionally robust and with a premium finish, the Amarok is built to impress, even in heavy use. A warp-resistant ladder frame, which guarantees excellent body stability, and special leaf springs allow for a maximum payload of up to 1,126kg¹ and a trailer load of up to 3.1 tonnes.



The fixed **tow bar** with a ball head design is exceptionally durable and manufactured to tow a trailer load of up to 3.1 tonne braked.¹ Optional on all models.

The standard **3+2 leaf springs** offer high driving comfort and the highest UK payload.

¹ Amarok Trendline 3.0 litre V6 TDI 204PS 4MOTION.

Please contact your local Volkswagen Commercial Vehicles Van centre for details of the standard equipment and optional extras available.



Larger.

The widest load platform in its class, allowing Euro pallets to be loaded crosswise.

No other pick-up provides so much space between the wheel housings. The loading width of 1,222mm even enables Euro pallets to be loaded crosswise. The spacious 2.52m² cargo area features some impressive dimensions – such as the 508mm high side panels and the low loading sill height of 780mm.

Please contact your local Volkswagen Commercial Vehicles Van centre for details of the standard equipment and optional extras available.



01 Load platform. The load platform in the Amarok is precisely 1,222mm across between the wheel housings – this is unique in its vehicle class and allows Euro pallets to be loaded across the platform. If necessary, the tailgate with a 200kg payload can be used as an extension of the load platform. When loaded to capacity, the cargo area offers space for 1.28m³ of bulk goods on a surface of 2.52m².

TL HL DL

02 Load platform lighting. Integrated lights illuminate the load platform, allowing you to load your cargo in the dark. In addition, it also features the integrated third brake light.

TL HL DL

01

02



03 Load compartment coating. The UV-resistant special coating in anthracite provides excellent protection against mechanical and chemical wear.

HL DL

04 12V sockets (not shown). Four 12V sockets are available, including one in the cargo area.

HL DL

Standard Optional

TL | Trendline HL | Highline DL | Dark Label

Exterior	Interior & comfort	Safety systems	Engines, running gear & transmission	Off-road performance	Towing capacity & payload	Load platform	Equipment lines	Paint & upholstery	Alloy wheels & interior & comfort	Infotainment & assistance systems	Mobile online services	Technical information	Build your own	Offers & finance	Service & warranties
----------	--------------------	----------------	--------------------------------------	----------------------	---------------------------	---------------	-----------------	--------------------	-----------------------------------	-----------------------------------	------------------------	-----------------------	----------------	------------------	----------------------

More individual.

A range of models with exclusive equipment.



Please contact your local Volkswagen Commercial Vehicles Van centre for details of the standard equipment and optional extras available.

The Amarok Trendline.

For every purpose.



17" 'Posadas' alloy wheels.

Choice of 6-speed manual with Selectable 4MOTION, or 8-speed automatic with Permanent 4MOTION.

Body-coloured front bumper.

Please contact your local Volkswagen Commercial Vehicles Van centre for details of the standard equipment and optional extras available.

The Amarok Trendline.

For every purpose.



Standard equipment – Trendline.

Audio and communications

- App-Connect
- Bluetooth® mobile phone preparation
- Composition Media DAB+ radio system with 6.33" touch-screen, voice enhancer, single MP3 compatible CD drive, SD card slot, USB interface, AUX-IN socket and six speakers
- Multi-function display plus
- Voice Control

Interior

- Carpet floor covering in cab and rear passenger area
- Centre console with cover for storage compartment
- 'Climatronic' air conditioning
- Cruise control
- Cup holder in cab
- Decorative inserts in Deep Inox
- Driver and passenger seats with armrests, height and lumbar adjustment
- Dust and pollen filter
- Electric windows
- Heater air vents in cab and rear passenger area
- Kemisu fabric upholstery
- Leather multi-function steering wheel, gearknob, gaiter and handbrake handle
- Moulded headlining
- Servotronic speed-related variable steering
- Smoking pack with individually mountable ashtray
- Storage compartments under front seats
- Three rear headrests
- Three-seat bench in rear row with ISOFIX mountings to outer seats
- Twin sun visors with vanity mirrors and airbag label on passenger sun visor
- Windscreen wiper intermittent control, including manual dimming mirror
- 12V sockets x 3

Exterior

- Black rear bumper with integrated step
- Body-coloured door mirrors, handles and front bumper with single chrome detailing in upper grille
- Centre high-mounted brake light
- Daytime running lights
- Door mirrors – electrically heated and adjustable
- Driver and front passenger seats with height adjustment
- Four load-lashing rings
- Front and rear fog lights
- Halogen twin headlights
- Headlight range adjustment
- Heated rear window
- Heat insulating glass
- Licence plate lighting
- Lockable tailgate
- Rear side windows and rear window in privacy glass
- Trailer hitch preparation
- Wide wheel arch extensions

Safety and Security

- Airbags – driver and front passenger side and front head protection
- Anti-lock Braking System (ABS)
- Automatic Post-Collision Braking System
- Electronic Stabilisation Programme (ESP)
- Hill Hold Assist
- Remote central locking with interior locking switch and two remote folding keys
- Seatbelt warning when not engaged
- Thatcham Category 1 approved alarm and immobiliser with back-up horn, tilt sensor and tow-away protection
- 17" braking system to the front and 16" braking system at the rear

Wheels and tyres

- 17" Posadas alloy wheels 8J x 17
- 245/65 R17 111T tyres
- Full size steel spare wheel
- Lockable wheel bolts
- Tool kit and jack



'Climatronic' air conditioning.

Watch video >



Composition Media DAB+ radio system.

Watch video >

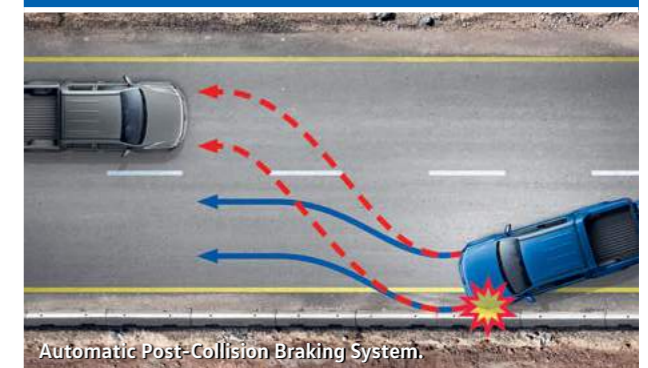

Automatic Post-Collision Braking System.



17 inch 'Posadas' alloy wheel.

Please contact your local Volkswagen Commercial Vehicles Van centre for details of the standard equipment and optional extras available.

The Amarok Highline.

For added refinement.



- Bi-xenon headlights.
- 18" 'Manaus' alloy wheel.
- Side bars in stainless steel.
- Two double chrome trims on the radiator grille.
- Chrome-plated rear bumper.

Please contact your local Volkswagen Commercial Vehicles Van centre for details of the standard equipment and optional extras available.

The Amarok Highline.

For added refinement.



'Vienna' leather seat upholstery.¹

Heated driver and front passenger seats with individual settings.

Front and rear parking sensors and rear-view camera.

¹ Centre seat panel and inner seat bolsters in 'Vienna' leather. The 'Vienna' upholstery is a leather seat upholstery with leatherette sections.

Please contact your local Volkswagen Commercial Vehicles Van centre for details of the standard equipment and optional extras available.

Additional equipment – Highline.

Interior

Decorative inserts in Light Silver

Heated driver and front passenger seats with individual control

Vienna leather upholstery¹

12V sockets x 4, including x 1 in the cargo area

Exterior

Additional exterior dust seals

Bi-xenon headlights with separate LED daytime running lights

Chrome rear bumper with integrated step

Darkened rear tail light lenses

Front and rear parking sensors with rear-view camera

Front grille with two chrome detailing strips and six vertical chrome ribs

Heated washer nozzles

LED licence plate lighting

Side bars in stainless steel

Washer fluid level indicator

Wheels and tyres

18" Manaus alloy wheels 7.5J x 18

255/60 R18 112T tyres



18 inch 'Manaus' alloy wheel.



Front and rear parking sensors.



Rear-view camera.



Bi-xenon headlights with separate LED daytime running lights.

¹ Centre seat panel and inner seat bolsters in 'Vienna' leather. The 'Vienna' upholstery is a leather seat upholstery with leatherette sections.

Please contact your local Volkswagen Commercial Vehicles Van centre for details of the standard equipment and optional extras available.

The Amarok Dark Label.

For confident road presence.



18" 'Rawson' alloy wheels.

'Dark Label' decals.

Exclusive 'Carbon Steel' metallic paint.

Lights & Vision pack.

Side bars and styling bar plus in matt black.

Discover Media navigation system including Guide & Inform.

Choice of 'Alcantara' or leather upholstery

Black headlining.

'Dark Label' pack.

Leather-trimmed multifunction steering wheel.

Please contact your local Volkswagen Commercial Vehicles Van centre for details of the standard equipment and optional extras available.

Additional equipment – Dark Label.

Audio and communications

Discover Media navigation system with 6.33" touch-screen, voice enhancer and Guide & Inform

Multi-function display premium

Interior

Black headlining

Choice of 'Alcantara' or leather upholstery

'Dark Label' floor mats

Decorative inserts in Deep Inox and vent bezels in chrome silk gloss

Lumbar support for seats in the first row, manually adjustable

Exterior

Black door handles

'Dark Label' decals

Exclusive 'Carbon Steel' metallic paint finish

Matt black exterior mirror housings

Rear bumper painted in black with integrated step

Side bars in matt black

Styling bar plus in matt black

Underbody styling

Safety and Security

Automatic headlight control with coming home and leaving home feature

Exterior mirrors power adjustable, heated and folding

Windshield wipers with rain sensor

Wheels and tyres

18" Rawson alloy wheels 7.5J x 18

255/60 R18 112H tyres



18 inch 'Rawson' alloy wheel.



Discover Media navigation system.



Matt black side bars.



Underbody styling.

Paint.



Candy White. Solid paint finish. TL HL



Tornado Red. Solid paint finish. TL HL



Carbon Steel. Metallic paint finish. DL



Indium Grey. Matt paint finish. HL DL



Reflex Silver. Metallic paint finish. TL HL



Mojave Beige. Metallic paint finish. TL HL



Indium Grey. Metallic paint finish. TL HL



Chestnut Brown. Metallic paint finish. TL HL



Starlight Blue. Metallic paint finish. TL HL



Ravenna Blue. Metallic paint finish. HL



Deep Black. Pearl Effect paint finish. TL HL DL

Standard Optional at extra cost
TL | Trendline HL | Highline DL | Dark Label

The illustrations on these pages can only be regarded as a general guide. Screen technology cannot render the colours with absolute accuracy. Please contact your local Volkswagen Commercial Vehicles Van centre for details of the standard equipment and optional extras available.

Exterior	Interior & comfort	Safety systems	Engines, running gear & transmission	Off-road performance	Towing capacity & payload	Load platform	Equipment lines	Paint & upholstery	Alloy wheels & interior & comfort	Infotainment & assistance systems	Mobile online services	Technical information	Build your own	Offers & finance	Service & warranties
----------	--------------------	----------------	--------------------------------------	----------------------	---------------------------	---------------	-----------------	--------------------	-----------------------------------	-----------------------------------	------------------------	-----------------------	----------------	------------------	----------------------

Upholstery.

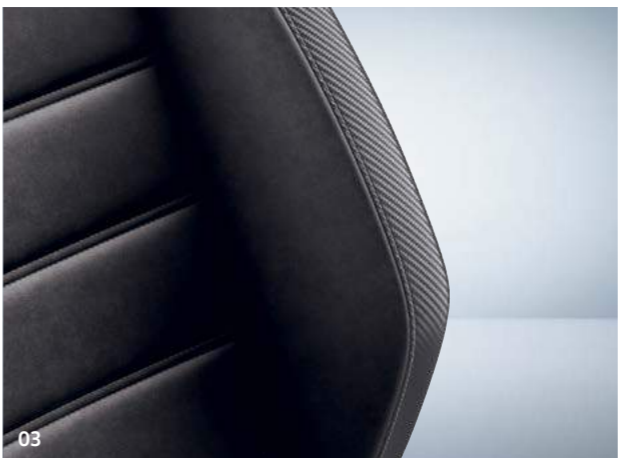
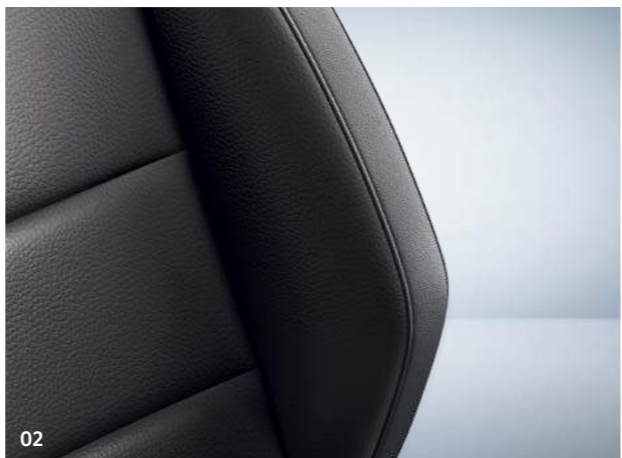
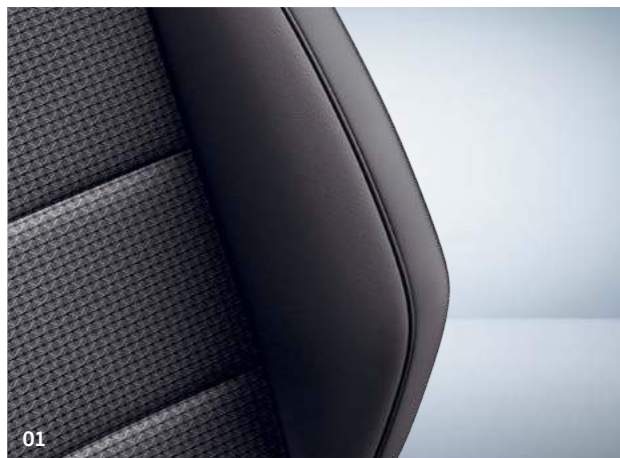

- 01 'Kemisu' cloth seat upholstery in Palladium Grey. **TL**
- 02 'Vienna'¹ leather seat upholstery in Palladium Grey and Titanium Black. Also available in Noisette Brown and Titanium Black. **HL DL**
- 03 'Alcantara' seat upholstery in Titanium Black. **TL DL**

Standard Optional at extra cost
 TL | Trendline HL | Highline DL | Dark Label

1 Centre seat panel and inner seat bolsters in 'Vienna' leather. The 'Vienna' upholstery is a leather seat upholstery with leatherette sections.

The illustrations on these pages can only be regarded as a general guide. Screen technology cannot render the colours with absolute accuracy. Please contact your local Volkswagen Commercial Vehicles Van centre for details of the standard equipment and optional extras available.

Please note: Dark Label models have a choice of either 'Vienna' leather or 'Alcantara' upholstery.

Alloy wheels.



01



02



03



04

01 17" 'Posadas' alloy wheel. 8.0 J x 17. With 245/65 R17 tyres. **TL**

02 18" 'Manaus' alloy wheel. 7.5 J x 18. With 255/60 R18 tyres. **HL**

03 18" 'Rawson' alloy wheel. 7.5 J x 18. With 255/60 R18 tyres. **DL**

04 19" 'Cantera' alloy wheel. 8.0 J x 19. With 255/55 R19 tyres. **HL**

Roll resistance-optimised tyres (not shown). All Amarok models are equipped with fuel-conserving summer tyres as standard. These are manufactured from a special rubber compound which minimises deformation from driving. This can reduce fuel consumption depending on the speed and driving style.

Please contact your local Volkswagen Commercial Vehicles Van centre for details of the standard equipment and optional extras available.

Interior and comfort.

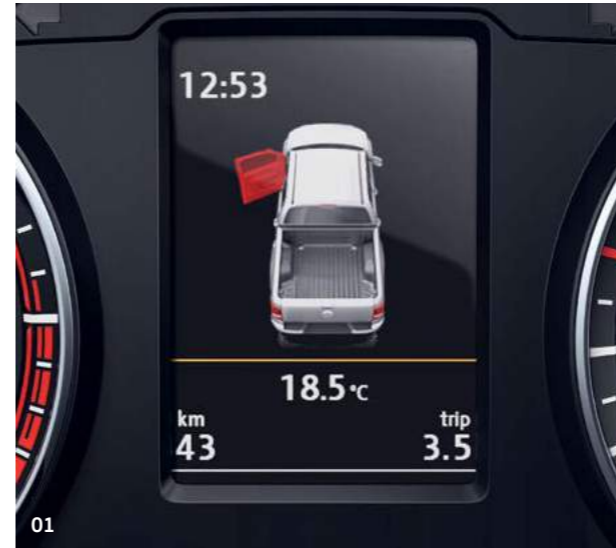

01



02



03

01 'Premium' colour multifunction display.

It comes with a high-resolution 3D colour display and animated menu guidance. Optional as part of the Navigation Tech package.

HL DL

Multifunction display plus (not shown).

It displays up-to-date information, such as remaining range, outside temperature and average fuel consumption.

TL HL

02 Leather-trimmed multifunction steering wheel with paddles.

It gives you excellent grip and is extremely user-friendly. The radio or navigation system and your mobile phone can be controlled using the buttons. Ergonomic paddles allow you to change gears for a sportier driving style.

TL HL

Winter pack (not shown). Making the start of the day that little bit more comfortable in the colder months. The package includes heated windscreen washer nozzles, a washer fluid display and seat heating for the driver and front passenger seat.

TL HL DL

03 'Climatronic' air conditioning. This system offers 2-zone temperature control for the driver and front passenger, manual air recirculation and an air quality sensor. Depending on the intensity of the sun's rays and the outside temperature, the air conditioning adds more or less cool air accordingly.

TL HL DL

Auxiliary water heater (not shown). It enables you to pre-heat the engine while also heating up the interior quicker, or pre-heating it before you get in. The control unit is built into the roof console. Of course, you can also activate and deactivate the auxiliary water heater using the handy remote control.

HL

Standard **Optional at extra cost**

TL | Trendline HL | Highline DL | Dark Label

Infotainment.



01



02 | 03



04

01 Voice control. Operate the telephone, navigation and audio functions without taking your hands off the steering wheel. This function allows you to call up virtually all of the menus and notifications on the radio or navigation system display using voice commands.

TL HL DL

Electronic voice enhancer (not shown).¹ This function makes sure that passengers in the rear seats can hear the driver. The voice input is recorded through a hands-free microphone, amplified, and then transmitted over the loudspeaker in the rear.

TL HL DL

02 Composition Media DAB+ radio system. The Composition Media DAB+ radio system features a 6.33" touch-screen with proximity sensor, USB port, Bluetooth®, SD card slot, AUX-IN interface, MP3 and WMA compatible CD drive, 4 x 20 watt output with four speakers and a dual tuner with PhaseDiversity for optimum radio reception. 'App-Connect' guarantees the best possible connection.²

TL HL

03 'App-Connect'.² With this software, selected apps from your smartphone can be used while driving. 'App-Connect' supports 'MirrorLink™', Apple 'CarPlay' and 'Android Auto'.

TL HL DL

04 Discover Media navigation system. In addition to the Composition Media features, it also includes a second SD card slot and an SD card with map data for Europe. Volkswagen MapCare provides access to free updates for the installed maps. 'Guide & Inform' is an extension of the Discover Media navigation system and retrieves the latest information from the internet. If, for instance, a traffic jam is building, your chosen route will be changed in response to this. You can also choose to display the cheapest petrol station nearby, find car parks, get updates on the latest news and weather and much more. 'Guide & Inform' can be activated in just a few steps and used free-of-charge for three years.³

TL HL DL

¹ The electronic voice amplification is included in the Composition Media radio system and Discover Media navigation system.

² Compatible with 'MirrorLink™', Apple 'CarPlay' and 'Android Auto'. Please ensure that your end device is compatible with 'App-Connect'. 'App-Connect' apps are operated exclusively through your mobile phone. Please note the conditions of your contract with regard to the data and Internet connection. Further information is available at www.volkswagen-commercial-vehicles-carnet.com

³ Only available in conjunction with the Discover Media navigation system. From the fourth year, usage carries an extra charge. In order to establish an Internet connection, the customer will require their own mobile wireless router (e.g. a smartphone with Hotspot capability) or a suitable USB dongle that works with their own SIM card with an internet data tariff.

Please contact your local Volkswagen Commercial Vehicles Van centre for details of the standard equipment and optional extras available.

Standard Optional at extra cost
TL | Trendline HL | Highline DL | Dark Label

Driver assistance systems.

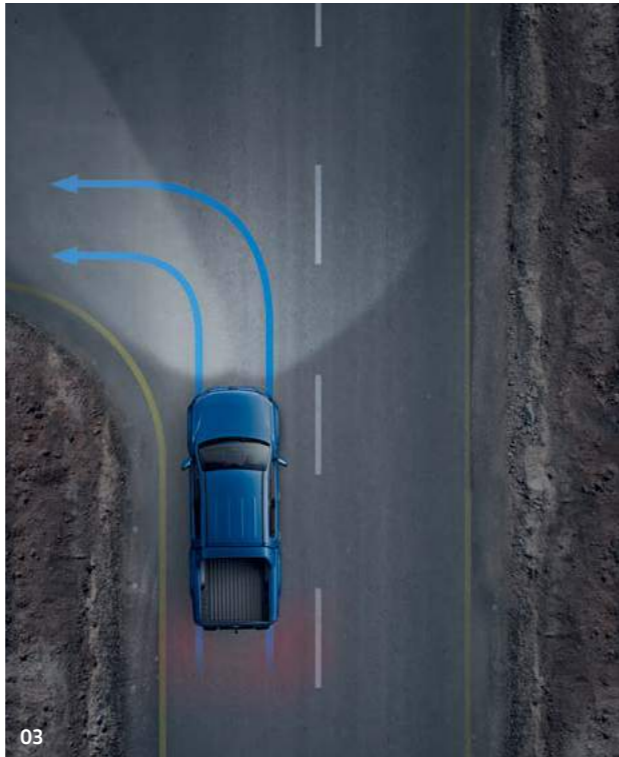

01 Parking sensors. ¹ Emits audible warnings when obstacles are detected in front of or behind the vehicle when parking, and also provides a visual display of the vehicle's distance from the obstacles. **TL HL DL**

02 Rear-view reversing camera. Simplifies parking by showing a limited view of the area behind the vehicle on the display of the radio or navigation system. Static guidelines facilitate the parking process. **TL HL DL**

Tyre pressure monitoring system (not shown). ¹ Measures the tyre pressure of each wheel on an ongoing basis and displays it on the multifunction display. The driver is warned if the pressure drops. **TL HL DL**

03 Fog lights with integrated static cornering lights. Ensures optimal visibility in poor weather conditions. The headlight nearest to the corner illuminates the roadside when turning. **TL HL DL**

Lights and Vision pack (not shown). The windscreen wipers are activated if it starts raining and the wiping interval is adapted to the intensity of the rainfall. Furthermore, the interior mirror is automatically tinted if the headlights in the vehicle behind are too bright. Also included in the package is an automatic headlight control for when light diminishes and the automatic 'coming home/leaving home' function. **TL HL DL**

¹ Within the system thresholds.
Please contact your local Volkswagen Commercial Vehicles Van centre for details of the standard equipment and optional extras available.

Standard Optional at extra cost
TL | Trendline HL | Highline DL | Dark Label

Safety systems.

01 Automatic Post-Collision Braking System. ¹ Triggers braking after a collision, with the aim of preventing secondary collisions. After a short delay, the vehicle begins a phased braking action down to 6 mph, during which the driver can intervene at any time. **TL HL DL**

Electronic stabilisation programme (not shown). Helps to prevent under- or over-steering via targeted braking of individual wheels. **TL HL DL**

02 Trailer stabilisation. ¹ Should the trailer start to deviate heavily, the system slows it down by means of controlled braking and reduced engine torque. This helps the trailer and increases driving safety. **TL HL DL**

Anti-theft warning system (not shown). Triggers acoustic and visual warnings at signs of unauthorised entry. As well as interior monitoring, the system includes an electronic immobiliser, a de-activatable safelock and a tow-away warning. **TL HL DL**

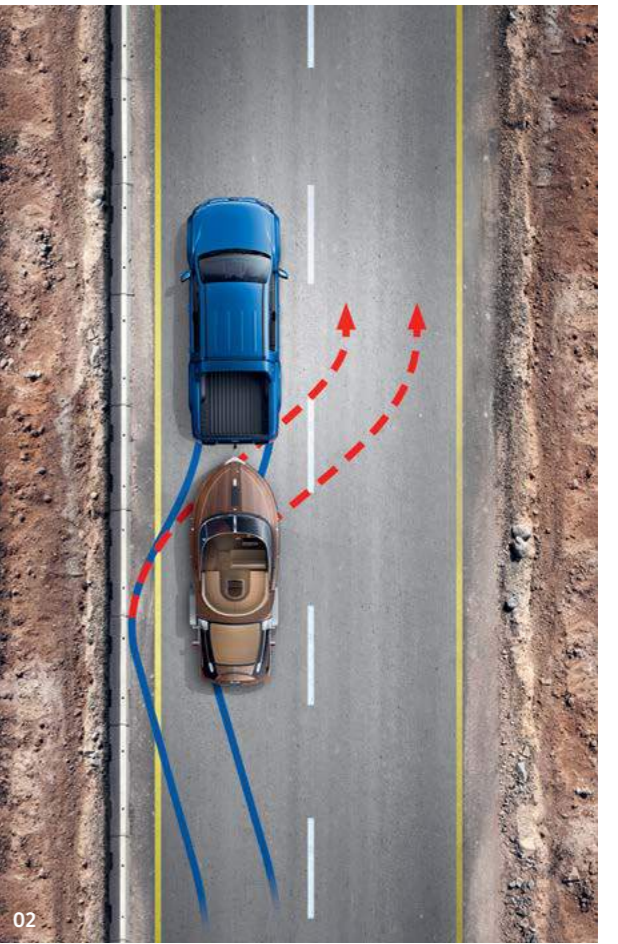
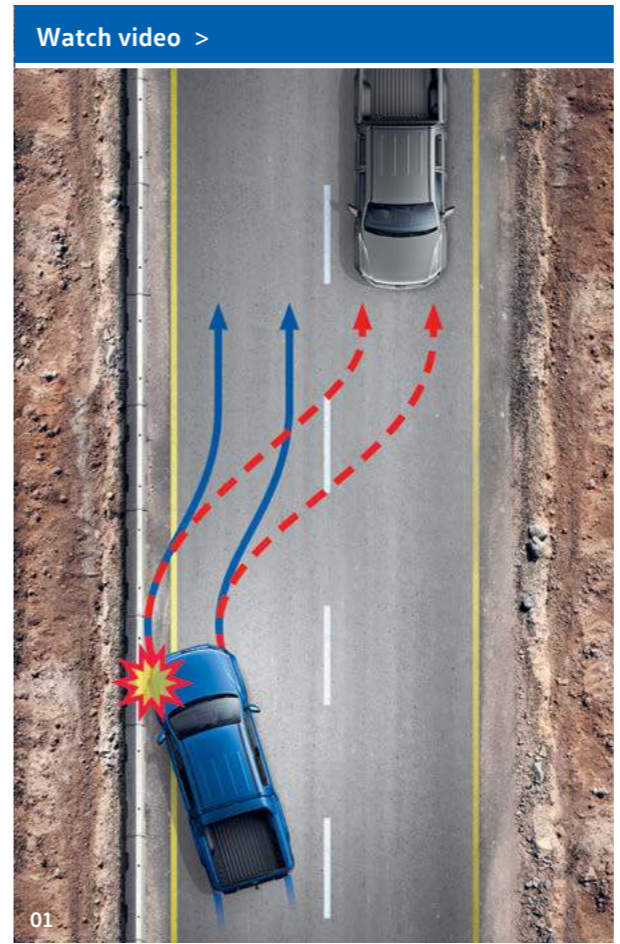

Perfectly connected.

The future of mobility is now the present – and available upon request in your Volkswagen commercial vehicle. The mobile online services enable you to enhance the Amarok, transforming it into an Internet-based information centre. 'App-Connect' enables you to conveniently use and control content on your smartphone even while driving.

TL HL DL

Using 'Guide & Inform', you expand the Discover Media navigation system to include numerous additional on-board information services.

TL HL DL



■ Standard □ Optional at extra cost
TL | Trendline HL | Highline DL | Dark Label

'App-Connect'.¹

Experience infotainment on the road and integrate your smartphone or tablet into your vehicle with 'App-Connect' via a USB port. 'App-Connect' mirrors compatible apps from your smartphone on the radio or navigation system's touchscreen display. Using 'Android Auto', Apple 'CarPlay' or 'MirrorLink™', you can comfortably control certain apps via the touchscreen display while driving.









You can use the following Volkswagen apps via 'MirrorLink™' while driving: 'Drive & Track', 'Shared Audio', 'Call & Remind' and 'My Guide'. More information is available at www.volkswagen-vans.co.uk/about-us/technology/car-net

'Guide & Inform'.²

If your vehicle is fitted with an optional navigation system, you can activate the online-based 'Guide & Inform' services. 'Guide & Inform' is available free of charge for the first three years after registration. You can utilise two types of services: services that support you directly in the vehicle and services you configure from home - either via the customer portal or via the Car-Net app. To use 'Guide & Inform' in the vehicle, simply generate a hotspot with your smartphone.





Well informed in your vehicle.

'Guide & Inform' keeps the driver up to date: with online-based traffic information, fuel station prices, available parking spaces nearby and a Google POI search in the navigation system.

-  Online Traffic Information
-  Fuel Info
-  Parking Info³
-  Online Traffic Information
-  News
-  Weather

Well organised from home.

Using the customer portal, you can set-up online routes, destinations and POIs and then import them into the navigation system. The Car-Net app also synchronises calendar entries and driving destinations.

-  Online Route Import
-  Online Destination Import
-  My POIs
-  Vehicle Health Report
-  Time Manager

Registration - A few simple steps:

- 1** 

Create your personal account at www.volkswagen-car-net.com/portal/en_GB/web/gb/login
- 2** 

Enter your vehicle identification number (VIN).
- 3** 

You receive an 8 digit registration code.
- 4** 

Use your smartphone to create a mobile hotspot or use the Volkswagen CarStick.
- 5** 

Enter the registration code into the navigation system.

¹ 'App-Connect' is available in conjunction with the Composition Media radio system or the Discover Media systems. 'App-Connect' comprises MirrorLink™, CarPlay™ and Android Auto™. The availability of these technologies may vary depending on the country in question. Please note that 'App-Connect' is not currently supported by every mobile telephone on the market. Volkswagen is working closely with major smartphone producers to promote broader compatibility for 'App-Connect'. ² The use of 'Guide & Inform' mobile online services is only possible with the optional Discover Media system. You will also require a mobile device (e.g. smartphone) that is capable of acting as a mobile wireless hotspot, which must be paid for separately. The Guide & Inform services are only available with an existing mobile network contract or one to be concluded separately for this purpose between you and your mobile phone network provider, and only within the respective mobile phone network coverage. Depending on your mobile phone tariff, receiving data from the Internet may incur additional charges, particularly if you are using the phone abroad (e.g. roaming charges). Due to the amount of data needed when using Car-Net services, we strongly recommend signing up to a flat rate data plan with your mobile phone provider. Use of Car-Net is governed in a separate agreement concluded online with Volkswagen AG. After receiving possession of the vehicle, the customer has 90 days in which to register the vehicle at www.volkswagen-car-net.com/portal/en_GB/web/gb/login. Availability of Car-Net Services may vary depending on the country in question. These services are available for the duration of the contract term agreed, and may be subject to changes in days of content during the contract period. More detailed information on Car-Net is available at www.volkswagen-vans.co.uk/about-us/technology/car-net and from your Volkswagen Partner; contact your mobile network provider for information on your mobile network tariff conditions. ³ Available for car parks with suitable technical infrastructure. There is currently no information available regarding entry heights for the car parks in question. Please contact your local Volkswagen Commercial Vehicles Van centre for details of the standard equipment and optional extras available.

Engine & gearbox data.

Engine specifications.	3.0 V6 TDI 163PS	3.0 V6 TDI 204PS	3.0 V6 TDI 224PS
Engine type	V6 cylinder diesel engine	V6 cylinder diesel engine	V6 cylinder diesel engine
Mixture preparation/injection method	Common-rail/exhaust-gas turbocharger	Common-rail/exhaust-gas turbocharger	Common-rail/exhaust-gas turbocharger
EU exhaust emission standard	EURO 6	EURO 6	EURO 6
Number of cylinders	6	6	6
Cubic capacity	2,970cc	2,970cc	2,970cc
Output, PS at rpm	163 at 2,750-4,500	204 at 3,000-4,500	224 at 3,000-4,500
Torque, max. Nm at rpm	450 at 1,250-2,500	500 at 1,250-2,750	550 at 1,400-2,750
Fuel tank capacity	80 litre	80 litre	80 litre
AdBlue® tank capacity	13 litre	13 litre	13 litre
Diesel Particulate Filter [DPF]	Yes	Yes	Yes
6-speed manual gearbox	Yes	Yes	No
8-speed automatic gearbox	No	Yes	Yes
Selectable 4MOTION all-wheel drive	Yes	Yes	No
Permanent 4MOTION all-wheel drive	No	Yes	Yes
Alternator	120A-180A	120A-180A	120A-180A
Battery	92Ah (520A)	92Ah (520A)	92Ah (520A)

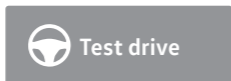
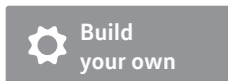

Fuel consumption, performance and emissions.

Engine/transmission	Urban mpg (ltr/100 km) ¹	Extra-Urban mpg (ltr/100 km) ¹	Combined mpg (ltr/100 km) ¹	Acceleration, seconds 0 - 62 mph	Top speed, mph, (where the law permits)	CO ₂ emissions, g/km ¹
Trendline.						
3.0 V6 TDI 163PS Selectable 4MOTION 6-speed manual	27.2 (10.4)	36.7 (7.7)	32.5 (8.7)	9.8	110	228
3.0 V6 TDI 204PS Selectable 4MOTION 6-speed manual	27.2 (10.4)	36.7 (7.7)	32.5 (8.7)	8.4	119	229
3.0 V6 TDI 204PS Permanent 4MOTION 8-speed automatic	31.4 (9.0)	37.2 (7.6)	34.9 (8.1)	9.1	117	212
Highline.						
3.0 V6 TDI 204PS Permanent 4MOTION 8-speed automatic	31.4 (9.0)	37.2 (7.6)	34.9 (8.1)	9.1	114	212
3.0 V6 TDI 224PS Permanent 4MOTION 8-speed automatic	31.4 (9.0)	37.2 (7.6)	34.9 (8.1)	8.0	119	212
Dark Label.						
3.0 V6 TDI 204PS Permanent 4MOTION 8-speed automatic	31.4 (9.0)	37.2 (7.6)	34.9 (8.1)	9.1	114	212

¹ Fuel consumption and CO₂ figures are obtained under standardised EU test conditions. This allows a direct comparison between different manufacturer models but may not represent the actual fuel consumption achieved in 'real world' driving conditions. In addition to the fuel efficiency of a vehicle, driving behaviour as well as other non-technical factors (such as environmental conditions, including weather and traffic) play a role in determining a vehicle's fuel consumption and CO₂ emissions. More information is available at www.dft.gov.uk/vca. Other factors including Gross Vehicle Weight, trimline, extra equipment, options and accessories (wheels, tyres, etc.) may change vehicle parameters such as the weight, rolling resistance of the tyres and the aerodynamics and thus influence the fuel consumption, CO₂ emissions and driving performance values.

Weights.

Engine/transmission	Gross vehicle weight, kg	Axle load limit, front/rear, kg	Trailer weight braked 12%/unbraked, kg	Gross train weight, kg	Unladen weight ¹ , kg	Payload ² , kg
Trendline.						
3.0 V6 TDI 163PS Selectable 4MOTION 6-speed manual	3,200	1,445 / 1,860	3,000 / 750	5,550	2,127	1,073
3.0 V6 TDI 204PS Selectable 4MOTION 6-speed manual	3,200	1,445 / 1,860	3,000 / 750	6,000	2,130	1,070
3.0 V6 TDI 204PS Permanent 4MOTION 8-speed automatic	3,290	1,445 / 1,930	3,100 / 750	6,000	2,144	1,146
Highline.						
3.0 V6 TDI 204PS Permanent 4MOTION 8-speed automatic	3,290	1,445 / 1,930	3,100 / 750	6,000	2,178	1,112
3.0 V6 TDI 224PS Permanent 4MOTION 8-speed automatic	3,290	1,445 / 1,930	3,100 / 750	6,000	2,178	1,112
Dark Label.						
3.0 V6 TDI 204PS Permanent 4MOTION 8-speed automatic	3,290	1,445 / 1,930	3,100 / 750	6,000	2,222	1,068

¹ Unladen weight includes approximately 90% fuel load.

² Payload = gross vehicle weight minus unladen weight. Quoted weights are for vehicles with standard specification. Unladen weight and payload may be influenced by trimline, factory options and Van Centre fitted accessories. Roof load limit: 100kg. Trailer nose weight: 140kg.

Dimensions.

Wheelbase		3,097
Length		5,254
Width		1,954
Load area	length	1,555
	width	1,620
	width between wheel arches	1,222
	load area	2.52m ²
Rear tailgate	width	1,364
	height	508
Ground clearance		192
Wading depth		500
Turning circle (wall to wall)		12.95m

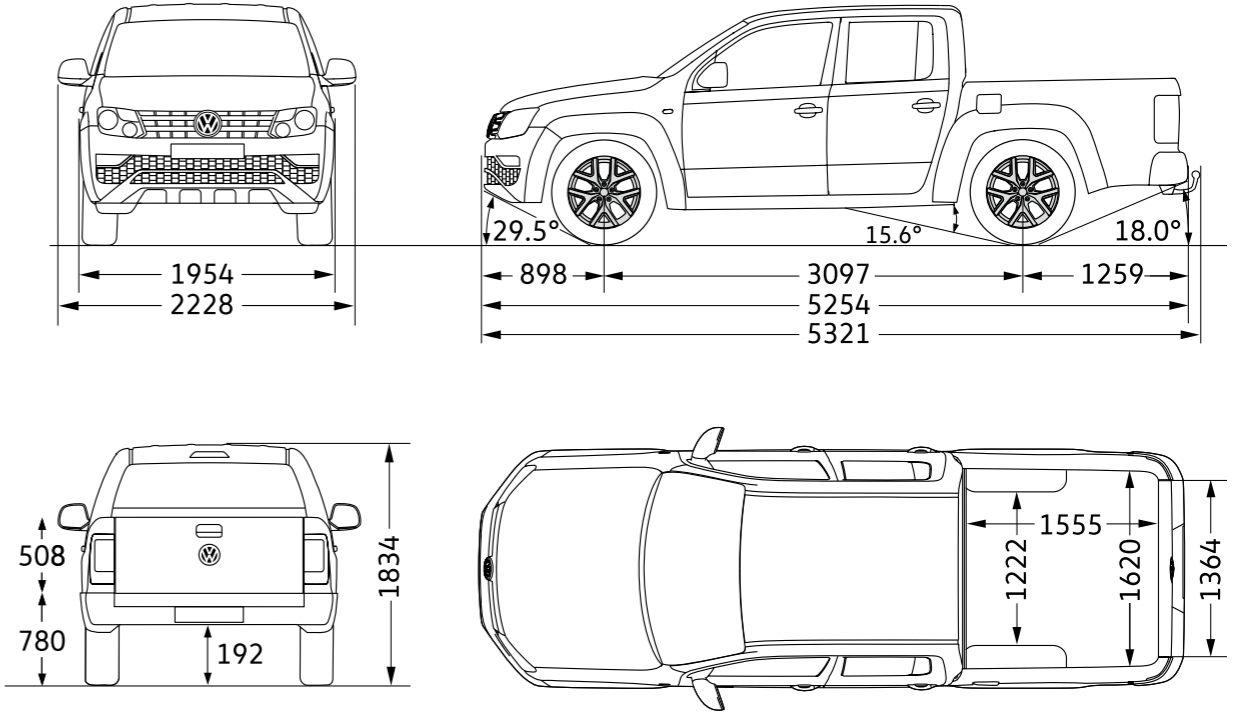

Please note: Vehicle drawings are not to scale. All dimensions in millimetres (mm), unless otherwise stated. The height measurements listed may vary by ± 50mm depending on model and equipment fitted.

Configure your Volkswagen van.

Load

Choose fewer models

Show all



Caddy Panel van



Caddy Kombi



Caddy Window van



Caddy Life



Transporter Single Cab



Transporter Double Cab



Transporter Panel van



Transporter Kombi



Transporter Window van



Transporter Shuttle



California



Caravelle



The NEW Crafter Single Cab



The NEW Crafter Double Cab



Amarok



The NEW Crafter Panel van



Book a test drive
Meet your new Volkswagen



Contact your local Van Centre
Talk to one of our experts



Load
Load a previous configuration

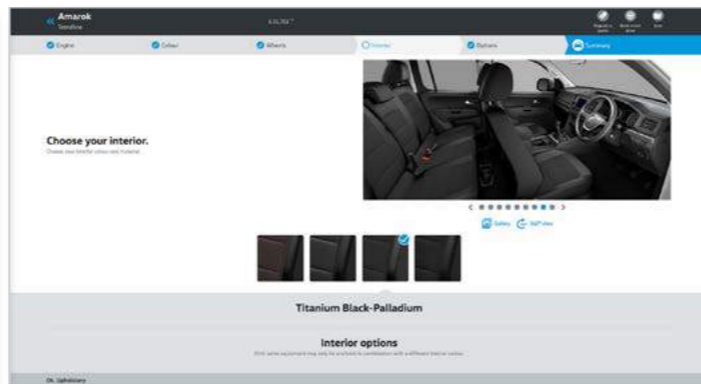
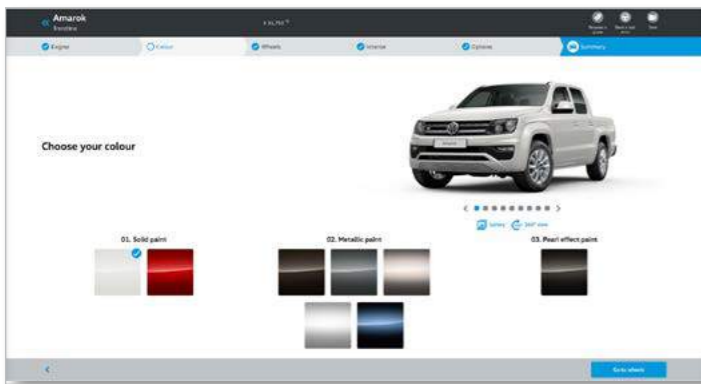

Build your own.

Create your perfect Volkswagen commercial vehicle with the 'build your own' configurator found on our web site by simply clicking on the button above.

Offers & finance.

Learn more about our range of finance products to find a finance package that suits you. Alternatively, take a look at the latest offers available to you.

Cost of your vehicle

Deposit
As little as one monthly repayment

Monthly repayments
Spread across 18 to 49 months

Optional final payment
You have three choices at the end of your agreement



Solutions Personal Contract Plan

Cost of your vehicle

Deposit
As little as one monthly repayment

Repayments
Spread across 12 to 60 months



Hire Purchase

Cost of your vehicle

Initial rental
As little as one rental repayment in advance

Rental repayments
Spread across 12 to 48 months

Final 'balloon' repayment



Lease Purchase

Cost of your vehicle

Initial rental
As little as one rental repayment

Repayments
Spread across 12 to 60 months



Contract Hire

Cost of your vehicle

Initial rental
As little as one rental repayment in advance

Repayments
Spread across 12 to 60 months



Finance Lease (full pay out)

Cost of your vehicle

Initial rental
As little as one rental repayment in advance

Rental repayments
Spread across 12 to 48 months

Final 'balloon' repayment
You have two options at the end of your agreement



Finance Lease (balloon repayment)

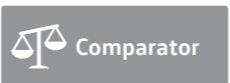
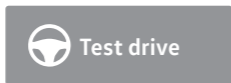
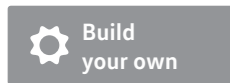

Service & warranties.

Finance and insurance.¹

When it comes to paying for your van, we've got options including Contract Hire and Finance Lease, or Hire Purchase. We can also offer you competitive insurance.

A choice of packages.²

Whether you prefer to lease your vehicles, with none of the concerns of ownership and the freedom to change models easily, or purchase outright to own the vehicle, we're here to help you consider your options.

You can go flexible, by choosing a payment plan that suits your finances, with options to reduce your monthly costs and your repayment period. Or choose a fixed monthly price that allows you to budget confidently for the longer term.

You can even include your road tax and servicing costs to arrive at one simple, all-inclusive payment. For more information, pick up a finance brochure, or ask at your Van Centre.

Volkswagen insurance.

Volkswagen Commercial Vehicles Insurance³ provides cost-effective and comprehensive motor insurance³, as well as gap insurance⁴, which helps replace your vehicle and protect you from any financial shortfall if it's written off.

Insurance benefits include:

- Complimentary 5-day insurance cover to allow you to drive your vehicle away.
- All repairs performed by approved repairers.
- Volkswagen Genuine Parts[®] used on all repairs.
- Courtesy vehicle provided during repair following an accident.
- Cover for breakage and damage to glass.
- In-vehicle personal belongings cover (up to £250).
- Vehicle recovery.
- 90-day European Union cover.
- Legal expenses cover (up to £100,000).

For more information about motor and gap insurance products, ask at your Van Centre, call **0330 303 6942**, or visit insurewithvwc.co.uk.

Servicing and support.

We're here to keep you moving, with our range of three award-winning⁵ servicing and maintenance options, as well as free Roadside Assistance. Some exclusions apply. For more detail, please visit www.volkswagen-vans.co.uk/aftersales.

Pay monthly.

This option is available for vehicles that are less than 12 months old and have covered less than 10,000 miles. It makes budgeting easier by splitting the cost of servicing into fixed monthly payments – whether you want Service only; Service and Maintenance; or Service, Maintenance and Tyres.

Pay upfront.⁶

If you can pay for more than one service upfront, we'll help by reducing your costs. Buy two upfront and you'll receive one interim and one full service at a discounted rate. Buy four and you'll receive two interim and two full services, with your next MOT also included.

Pay on demand.

If you're looking for freedom and flexibility with your servicing, it's good to know we're ready when you are. So with our third option, you can choose to pay for your services as and when you need them, with our National Service Pricing. Ask your Van Centre for an up-to-date pricing guide.

Roadside Assistance.

We understand the need to keep you mobile. That's why all new vans come with three-year, unlimited mileage roadside cover. Should the unexpected happen, one call gets you straight through to a team trained to help you through any breakdown or accident. Supporting you every day will be a team of vehicle technicians, fully-trained by Volkswagen and carrying the latest diagnostic equipment, specialist tools and parts.

Assistance benefits include:

- Assistance at home, by the roadside or place of work.
- Recovery to your preferred location.
- Onward travel, for you and your cargo.
- Cover 24 hours a day, 365 days a year.
- Free cover for three years (on new vehicles).
- Unlimited mileage.
- European cover.
- Option to extend cover beyond three years.

Warranties.

You can count on us long after you purchase your vehicle, thanks to its comprehensive three-year, 100,000 mile warranty. While your vehicle is under warranty, we'll fix any defect in manufacture or workmanship free of charge, even if you purchase and service the vehicle at different Van Centres. Some exclusions apply and the vehicle must be cared for using the guidance in your owner's manual. For more detail, please visit www.volkswagen-vans.co.uk/aftersales.

Extended warranty.

You can also extend your warranty beyond the three-year, 100,000 mile period, choosing either Comprehensive or Major Component cover, as a one-off or monthly payment. For more detail of cover levels, along with terms and conditions, please visit volkswagencvwarranty.co.uk where you'll also be able to obtain a quote and purchase an extended warranty.

Paint and body warranty.

Your vehicle's exterior paintwork is covered against manufacturing defects for a period of three years, while its body sections and panels are covered against rusting through from the inside for 12 years. Some exclusions apply and the vehicle must be cared for using the guidance in your owner's manual.

The Van Centre network.

Our **dedicated Van Centre network** is at the core of everything we do and is always there to help. As a separate brand within the Volkswagen Group, it makes sense to make use of your nearest Van Centre – it's full of experts who understand your vehicle better than anyone else and can help you to get the most out of it.

Over **70 Van Centres** and **24 Authorised Repairers**, means you're only around 45 minutes on average from our door.

1 Volkswagen Commercial Vehicles Insurance and Volkswagen Commercial Vehicle Financial Services are trading names of Volkswagen Financial Services (UK) Limited, Brunswick Court, Yeomans Drive, Blakelands, Milton Keynes MK14 5LR, which is authorised and regulated by the Financial Conduct Authority (FCA). Registered in England and Wales No. 2835230. Volkswagen Financial Services (UK) Limited financial services register number is 311988.

2 An offer of finance depends on certain conditions. Finance subject to status. Available to 18s and over. Terms and conditions apply. Volkswagen Commercial Vehicle Financial Services.

3 Volkswagen Commercial Vehicles Motor Insurance from Volkswagen Insurance Service (Great Britain) Limited is sold and administered by Ageas Retail Limited. Registered in England and Wales No. 1324965. Registered Office: Ageas House, Hampshire Corporate Park, Templars Way, Eastleigh, Hampshire SO53 3YA. Ageas Retail Limited is authorised and regulated by the Financial Conduct Authority, registration number 312468. Volkswagen Insurance Service (Great Britain) Limited is an appointed representative of Volkswagen Financial Services (UK) Limited.

4 Volkswagen Commercial Vehicle Insurance gap insurance is underwritten by MAPFRE Asistencia Compañía Internacional de Seguros y Reaseguros Sociedad Anonima authorised by Dirección General de Seguros y Fondos de Pensiones and subject to limited regulation by the Financial Conduct Authority and Prudential Regulation Authority, number 203041. Details about the extent of their regulation by the Financial Conduct Authority and Prudential Regulation Authority are available on request. MAPFRE Asistencia Compañía Internacional de Seguros y Reaseguros Sociedad Anonima is incorporated and registered in the Kingdom of Spain and registered as a foreign company in the United Kingdom with company number FC021974, acting through its UK branch with branch number BR008042 and whose principal office is at Alpha House, 5th Floor, 24A Lime Street, London EC3M 7HS. Volkswagen Commercial Vehicle Insurance gap insurance is administered by Abraxas Insurance Administration Services Limited, who is authorised and regulated by the Financial Conduct Authority with FCA number 308702 and who acts on behalf of the Insurer. Abraxas Insurance Administration Services Limited is registered in England and Wales with company number: 02928787 and whose registered office is at One Glass Wharf, Bristol BS2 0SX. Volkswagen Financial Services (UK) Limited is authorised and regulated by the Financial Conduct Authority (FCA). Authorisation details can be checked on the Financial Services register at www.fca.org.uk/firms/systems-reporting/register or call 0800 111 6768. Volkswagen Financial Services (UK) Limited is not part of the same corporate group as MAPFRE Asistencia Compañía Internacional de Seguros y Reaseguros Sociedad Anonima and Abraxas Insurance Administration Service Limited.

5 Business Vans Awards 2014 and 2015: Best Service Package for Van Owners.

6 Class 4 MOT only. This option is available to all new and used vehicles up to four years old or with less than 80,000 miles on the clock. Services must be used consecutively prior to vehicle reaching eight years old.

Exterior	Interior & comfort	Safety systems	Engines, running gear & transmission	Off-road performance	Towing capacity & payload	Load platform	Equipment lines	Paint & upholstery	Alloy wheels & interior & comfort	Infotainment & assistance systems	Mobile online services	Technical information	Build your own	Offers & finance	Service & warranties
----------	--------------------	----------------	--------------------------------------	----------------------	---------------------------	---------------	-----------------	--------------------	-----------------------------------	-----------------------------------	------------------------	-----------------------	----------------	------------------	----------------------

 Build
your own

 Find a
Van Centre

 Test drive

 Offers &
Finance

 Conversions

 Comparator



The Amarok

VWVW18AMAROK

This brochure supersedes all previous publications.

Issue: 8 February 2018

www.volkswagen-vans.co.uk

Please note: Screen technology does not allow exact reproduction of the paint and upholstery colours. Some of the vehicles shown are European specification and may be fitted with optional equipment or accessories that are available at extra cost, or do not reflect current specification. All data and specifications are in accordance with information available at the time of publication and are subject to change without notice. Vehicles not currently in UK stock and customer order vehicles may take a number of weeks for delivery. Certain combinations of vehicle specifications and factory-fitted options are not compatible and therefore all orders received are subject to confirmation. Models, factory fitted-options and paint and upholstery options are subject to availability. Please check details and availability with an authorised Volkswagen Van Centre at the time of ordering.