

The Caddy Life Brochure

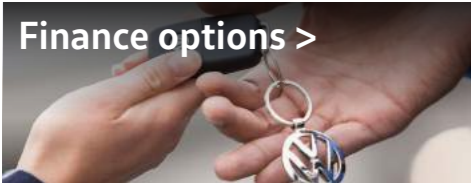

Commercial
Vehicles

Contents

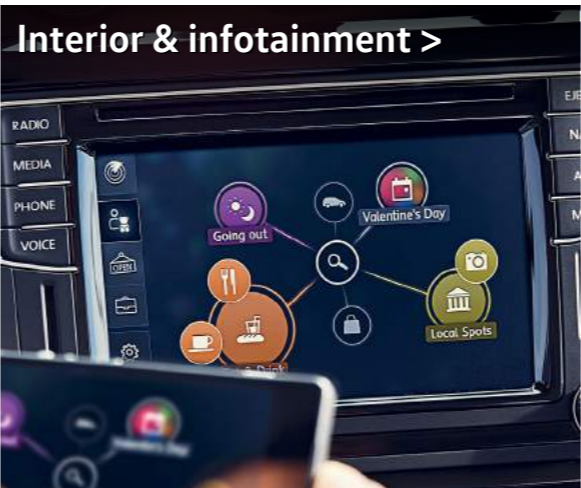
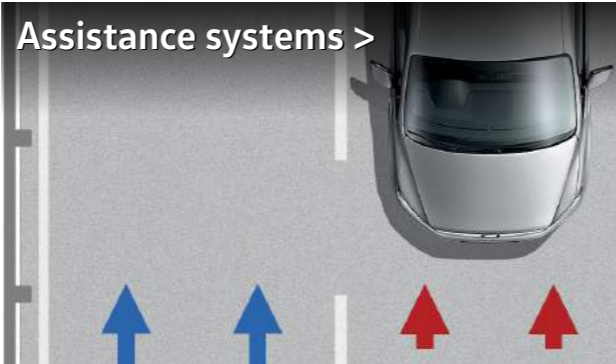

Designed for everyday life.

No matter how you look at it, the Caddy Life impresses from every angle. Designed for life, its uncluttered contours and dynamic styling deliver a bold stance. Clever design details such as the tailgate's integrated roof spoiler, elegantly sculptured rear light clusters, stylish side indicators and an attractive range of alloy wheels help it to stand out – whether it's a family holiday or the regular school run.



Optional Bi-xenon headlights.



Standard stylish rear light clusters.



Standard side sliding doors with sliding windows and child locks. Optional privacy glass is also available.



Stylish 17" Canyon alloy wheels. Optional on Caddy Maxi Life models.

The interior.

Step inside the Caddy Life and you'll find a quality interior that's attractive, ergonomic and rugged. Seating up to seven (including the driver), you'll feel totally at home in a driver's seat with 8-way adjustment, including height and lumbar support and a leather steering wheel that adjusts for reach and rake. Of course, safety is of paramount importance, so the driver and front passenger receive front and curtain airbags, height-adjustable headrests, 3-point seatbelts that adjust for height and seatbelt tensioners as standard. At the rear there's seating for up to five further passengers along two rows of seats. These also feature curtain airbags, 3-point seatbelts and height-adjustable headrests as standard. For the protection of younger passengers, ISOFIX child seat mountings are fitted to the two outer seats on the three-seat bench in the second row. In a vehicle where flexibility is key, you'll find the rear passenger area includes a host of storage solutions and supportive, flexible seating that can be configured in a variety of positions, or completely removed to create a cavernous load area that's able to cope with most of what life can throw at it.



Optional Composition Media DAB+ radio system.



Standard leather multi-functional steering wheel.



Optional App-Connect system.

Infotainment systems.

When you get behind the wheel of the Caddy Life, you'll be greeted by an ergonomic, highly-specified interior with quality finishing and an exclusive atmosphere. With the current generation Caddy Life, we've taken things a step further by offering a range of stylish and innovative radio and infotainment systems.

Radio and navigation. Devices include the standard Composition Colour touch-screen DAB+ radio system and optional Composition Media DAB+ radio system.

App-Connect. Available as an option, App-Connect allows you to operate special apps. The screen of your smartphone can be shown on the radio system's display.

Connectivity. Available as an option, external media devices, such as MP3 players, can be connected via an additional USB port. Furthermore, the standard mobile phone interface offers a Bluetooth® hands-free speaking system.

The flexible passenger compartment.

When you need to transport passengers and their luggage, we know that flexibility is key. With this in-mind, we've designed the Caddy Life's passenger compartment to offer versatility in abundance with seats that can be folded, double-folded or completely removed. What's more, with the optional load-through facility, the interior load length increases to an impressive 3.1m. When you also consider the low rear sill height and flat load surface, you'll discover a passenger compartment that's as spacious as it is flexible.

Caddy Life.
Standard 5 seats.



5 Seats

Caddy Maxi Life.
Standard 7 seats.



7 Seats

The Caddy Maxi Life is 470mm longer than the Caddy Life and offers an additional 340 litres of luggage space.



Second row bench folded down.

Second row bench folded forward.

Second row bench removed.

Safety systems.

Your safety is vital, so we ensure that a long list of safety and security features are built into every vehicle we produce. Since we first introduced structural safety features on commercial vehicles over 35 years ago, Volkswagen has maintained a policy of continuous safety development. Every Volkswagen model incorporates a range of both active and passive safety features, to help ensure the safety and security of both you, your passengers and your load.

With the vehicle's design contributing to safety, occupants are securely enclosed within a rigid safety cell with crumple zones to absorb crash energy, while the chassis and suspension are designed for excellent directional stability and handling. Features such as Anti-lock Braking System (ABS), Electronic Brakeforce Distribution (EBD), Electronic Stabilisation Programme (ESP), driver and passenger front and curtain airbags, electric seatbelt tensioners, Automatic Post-Collision Braking System and ISOFIX child seat mountings to the outer seats in the rear passenger area are fitted as standard.

For additional security and protection, an electronic immobiliser and remote central locking with dead locking and internal locking button are standard, while optional features such as anti-theft devices, front and rear parking sensors, Bi-xenon headlights, automatic rain-sensing wipers and front fog lights with integrated cornering lights all offer additional peace-of-mind.



Automatic Post-Collision Braking System.
Standard on all Caddy Life and Caddy Maxi Life models, it triggers braking after a collision, with the aim of preventing secondary collisions.



Electronic Stabilisation Programme (ESP).
Designed to prevent the vehicle from swerving in critical driving conditions by controlled and targeted intervention in the brake and engine management. This helps to maximise directional stability.



Anti-lock Braking System (ABS).
Designed to prevent wheels from locking up and assist manoeuvrability of the vehicle under heavy braking.



Traction Control System (TCS).
Aids smooth starts and acceleration by reducing wheel-spin. The system also incorporates the Electronic Differential Lock (EDL) and makes up part of the Electronic Stabilisation Programme (ESP).



Electronic Differential Lock (EDL).
Allows smooth starts on slippery or loose road surfaces. If one wheel starts to spin, EDL is designed to brake the wheel as necessary, directing power to the wheel with greater traction.



Airbags.
Driver and passenger front and curtain airbags are standard for the first time, as are curtain airbags for rear passengers. They offer occupants improved protection in the event of head-on or side impacts..



Seatbelt warning.
The seatbelt warning reminds the driver that their seatbelt is not fastened. Audio and visual signals are used to request that the seatbelt is fastened before driving.

[Watch video >](#)



Automatic Post-Collision Braking System.
Standard on all Transporter models, it triggers braking after a collision, with the aim of preventing secondary collisions.



Driver assistance systems.







To help ensure every journey ends as stress-free as it begins, the Caddy Life and Caddy Maxi Life are equipped with a number of intelligent systems – all of which are activated in critical situations as a preventative measure. Add to this a variety of innovative driver assistance systems and you'll discover the Caddy Life and Caddy Maxi Life offer high levels of safety and peace-of-mind.



Optional parking sensor display.



Optional rear-view camera display.

 <p>Cruise control including speed limiter. Fitted as standard, cruise control maintains the selected speed, or limits the top speed to a value set by the driver.</p>	 <p>Brake Assist. Fitted as standard, the system registers the speed at which the brake pedal is pressed. During emergency braking, it helps ensure full brake pressure is applied more quickly.</p>	 <p>Hill Hold Assist. Fitted as standard, the convenient Hill Hold Assist helps to prevent your vehicle from rolling back when pulling away on an incline. The hold operates for approximately two seconds.</p>
 <p>Driver Alert System. Fitted as standard, the Driver Alert System registers deviation from normal steering patterns and uses visual and acoustic warnings to recommend that the driver takes a break.</p>	 <p>Daytime running lights. Fitted as standard, daytime running lights offer increased visibility. For extra driver convenience, the dipped beam headlights are automatically switched on when you start your vehicle.</p>	 <p>Tyre pressure monitoring. Fitted as standard, the tyre pressure monitoring display activates a warning signal to highlight significant changes in tyre pressure. This lets the driver know that the tyre pressure should be checked as soon as possible.</p>

An intelligent driving experience. Assistance when you need it.

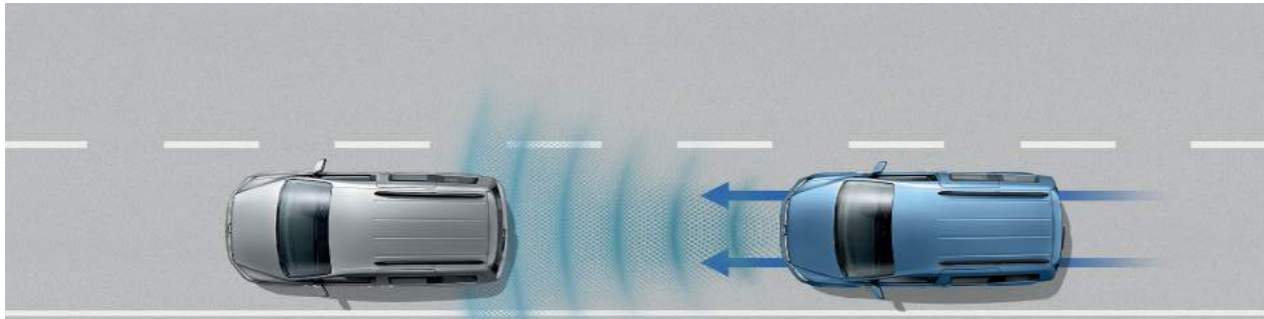

Front Assist with City Emergency Braking System.

Standard Front Assist area monitoring system with City Emergency Braking System detects critical distances, warns of hazardous situations and when necessary, triggers emergency braking.



Adaptive Cruise Control (ACC).

Available as an option, ACC uses a front radar to measure the distance (up to 120m) and speed relative to vehicles driving ahead. It automatically regulates the pre-set distance.

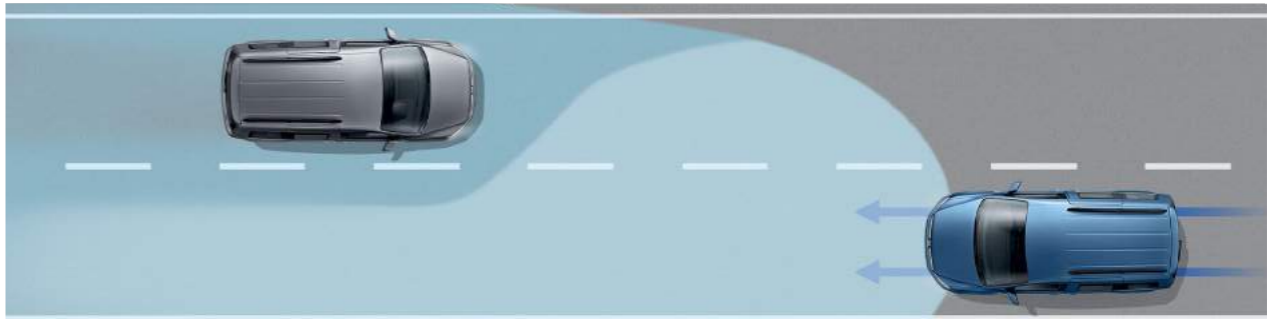

High Beam Assist.

Available as an option, High Beam Assist automatically dips the headlights and prevents dazzle for oncoming vehicles, or vehicles travelling ahead. At night time at speeds of above 37mph, the system automatically switches the headlights to high-beam.

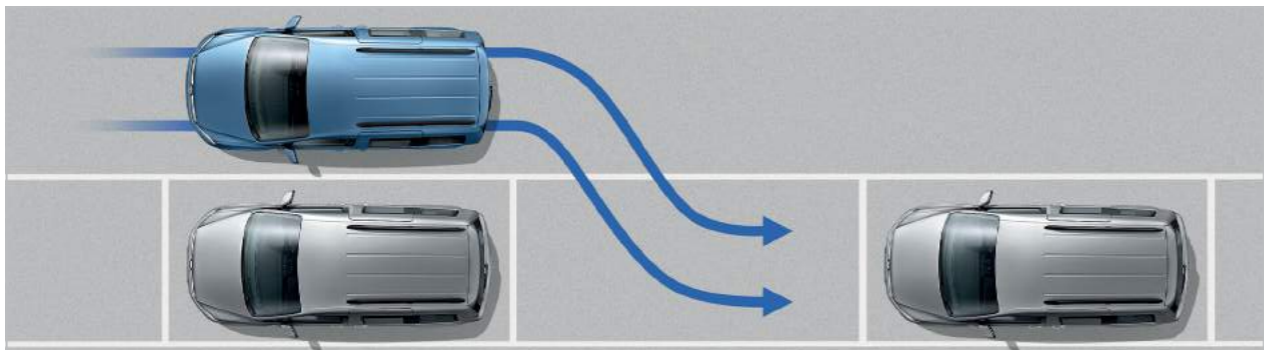

Park Assist.

This useful option aids positioning into parking spaces. When reverse is engaged, the vehicle assumes control of the steering. All that's required of the driver is to operate the clutch, accelerator and brake pedals.

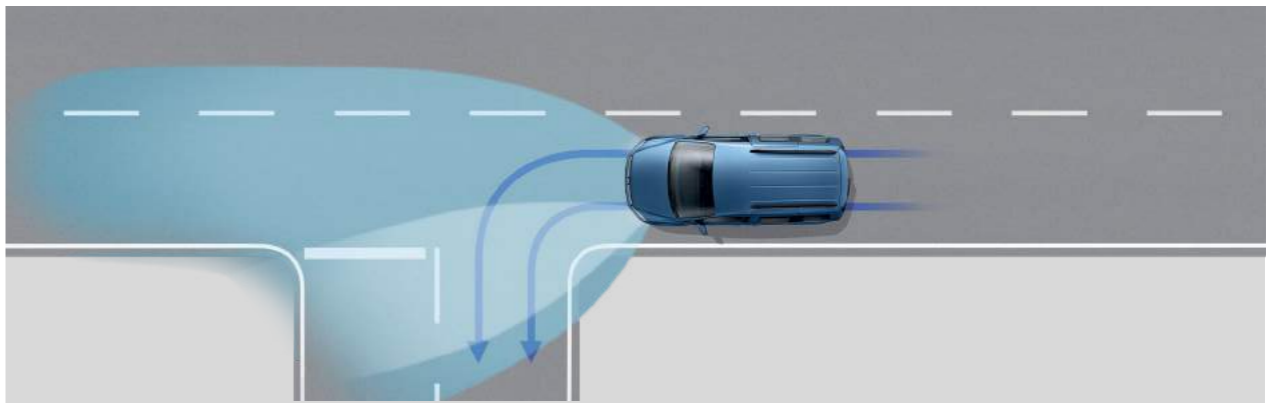

Fog lights with integrated cornering lights.

Available as an option, these help to illuminate curves and bends in the road ahead. This aids the driver in spotting any obstacles where the vehicle is turning.

The Caddy Life.

When you need a vehicle with the ability to adapt to your way of life, be it private or commercial use, the Caddy Life has the answer. Seating up to five (including the driver) as standard, it's as equally at home whether packed with passengers, or with the seats removed, loaded with bikes, luggage, camping gear and other bulky items that wouldn't easily fit into a conventional passenger vehicle. Access is through near-side and off-side sliding doors and a standard tailgate with heated window and wash-wipe. If preferred, glazed asymmetric rear wing doors can be specified as an option. With a comprehensive standard specification including, full wheel trims and sumptuous Kutamo cloth upholstery, the Caddy Life is ideal for users who desire more.

Starting from **£23,035[†]** [Please click here for more details.](#)



Climatic air conditioning for cab and rear passenger area.



Standard open storage tray with 12V socket.



Standard above-cab storage shelf.

[†] Volkswagen Commercial Vehicles may change RRP's at any time (this includes where there are government changes in regulation and/or legislation). There may be a delay to any RRP displaying correctly on our materials. Always obtain prices from your chosen authorised Van Centre.

Design	Interior & infotainment	Seating configurations	Assistance systems	Caddy Life	Caddy Maxi Life	Caddy Life & Maxi Life standard equipment	Paint & upholstery	Wheels, audio & communications	Mobile online services	Technical information	Price list	Finance options	Finance, insurance, servicing & warranties
------------------------	---	--	------------------------------------	----------------------------	---------------------------------	---	--	--	--	---------------------------------------	----------------------------	---------------------------------	--

The Caddy Maxi Life.

Starting from **£26,011†**

Please click here for more details.

The Caddy Maxi Life features a near identical specification to the shorter Caddy Life, with the addition of the most valuable of commodities – more space. Seating up to seven as standard (including the driver), it's 470mm longer and offers an impressive extra 340 litres of load capacity. For passengers, this means more space to relax, but most importantly, extra space for luggage or kit. What's more, for the perfect finishing touches, 16 or 17 inch stylish alloy wheels contribute to the road presence of the Caddy Maxi Life. Offering a blend of comfort, flexibility and space, it's the perfect family vehicle.



† Volkswagen Commercial Vehicles may change RRP's at any time (this includes where there are government changes in regulation and/or legislation). There may be a delay to any RRP displaying correctly on our materials. Always obtain prices from your chosen authorised Van Centre.

Design	Interior & infotainment	Seating configurations	Assistance systems	Caddy Life	Caddy Maxi Life	Caddy Life & Maxi Life standard equipment	Paint & upholstery	Wheels, audio & communications	Mobile online services	Technical information	Price list	Finance options	Finance, insurance, servicing & warranties
------------------------	---	--	------------------------------------	----------------------------	---------------------------------	---	--	--	--	---------------------------------------	----------------------------	---------------------------------	--

Caddy Life and Caddy Maxi Life standard equipment.

Audio and communications.

Composition Colour DAB+ radio including AUX-IN, SD card slot, Bluetooth®, MP3 compatible CD player and six speakers.

Wheels and tyres.

15" full wheel trims (Caddy Life).

16" Fortaleza alloy wheels (Caddy Maxi Life).

Full size steel spare wheel.

Tool kit and jack.

Efficiency technology.

Hill Hold Assist.

Low rolling resistance tyres.

Regenerative braking.

Start/Stop.

Exterior.

Body-coloured door mirrors and handles.

Body-coloured front and rear bumpers.

Fixed side windows in third row.

Front fog lights.

Heated windscreen (TDI models only).

Radiator grille with single chrome finishing strip.

Roof rails finished in Black.

Side sliding doors to passenger compartment on driver and passenger side.

Sliding windows and child locks within both side sliding doors to passenger compartment.

Tailgate with heated window and wash-wipe.



15" full wheel trims. Standard on Caddy Life 102PS.



Radiator grille with single chrome finishing strip.



16" Fortaleza alloy wheels. Standard on Caddy Maxi Life.



Front fog lights. Also available with optional cornering lights.



Composition Colour DAB+ radio system.

Caddy Life and Caddy Maxi Life standard equipment (continued).

Interior – cab area.

- Carpet floor covering.
- Centre armrest between driver and front passenger seats.
- Climatic manually controlled air conditioning with dust and pollen filter and air recirculation.
- Digital clock.
- Dimmable dashboard illumination.
- Door mirrors – electrically heated and adjustable.
- Driver seat with 8-way adjustment, including height and lumbar support.
- Electric front windows.
- Four drinks holders and storage compartment in centre console.
- Interior light in headliner.
- Kutamo cloth upholstery.
- Leather multi-function steering wheel, gearknob and gaiter.
- Lockable glovebox with illumination.
- Passenger seat with 8-way adjustment, including lumbar support.
- Reach and rake adjustable steering column.
- Rear-view mirror with anti-dazzle function.
- Servotronic speed-related power-assisted steering.
- Trip computer with multi-function display.
- Twin sun visors with vanity mirrors.
- Under-seat storage compartment below driver and front passenger seats.
- 12V sockets x 3 – dashboard front, dashboard top tray and luggage compartment.

Interior – passenger area.

- Carpet floor covering.
- Five seats, including the driver (Caddy Life).
- Folding luggage compartment cover.
- Four overhead nets.
- Kutamo cloth upholstery.
- Seven seats, including the driver (Caddy Maxi Life).
- Six load-lashing rings.
- Three-seat bench in second row – split/folding and removable with ISOFIX mountings to outer seats.
- Two door-activated interior lights.
- Two-seat bench in third row – removable (Caddy Maxi Life).



Load-lashing rings.



Climatic air conditioning for cab and rear passenger area.

Safety and security.

- Airbags – driver and front passenger (with passenger deactivation), front side and curtain head protection to front and second row.
- Anti-lock Braking System (ABS).
- Automatic hazard light activation under emergency braking.
- Cruise control with speed limiter.
- Electronic Brakeforce Distribution (EBD).
- Electronic Differential lock (EDL).
- Electric seatbelt tensioners.
- Electronic Stabilisation Programme (ESP).
- Engine drag torque control (MSR).
- Front Assist with City Emergency Braking System.
- Halogen main headlights with range control and daytime running lights.
- Height-adjustable head restraints.
- Remote central locking with deadlocks, interior locking and two remote keys.
- Seatbelt warning when not engaged.
- Thatcham category 1 approved alarm and immobiliser.
- Traction Control System (TCS).
- Visibility pack including auto-dimming rear-view mirror, rain sensors with automatic wipers and intermittent control.



Electric front windows.

Paint and upholstery.

Formulated to withstand the rigours of everyday life, the Caddy Life's paint and upholstery are designed to stand the test of time. As you'd expect from any Volkswagen, exterior paints offer a smooth and tough finish, while the interior upholstery is made from high-quality materials that are both attractive and robust.



Candy White solid paint



Cherry Red solid paint



Reflex Silver metallic paint.¹



Indium Grey metallic paint.¹



Sandstorm Yellow metallic paint.¹



Fortana Red metallic paint.¹



Blackberry metallic paint.¹



Chestnut Brown metallic paint.¹



Viper Green metallic paint.¹



Starlight Blue metallic paint.¹



Acapulco Blue metallic paint.¹



Deep Black pearl effect paint.¹

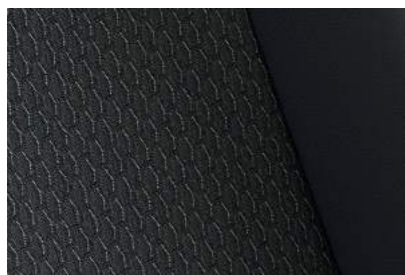

Kutamo L ML
Titanium Black/Moonrock Grey cloth

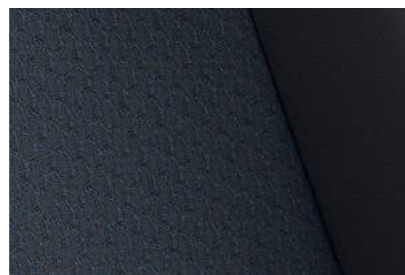

Kutamo L ML
Titanium Black/Blue cloth

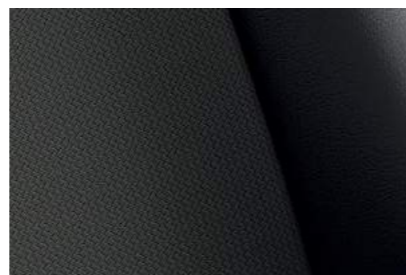

Mesh¹ L ML
Titanium Black synthetic leather

¹ Available at extra cost.

Please note: Not all paint and upholstery combinations can be ordered together and in some instances certain combinations may incur extra cost. Not all paint finishes may be available for every trimline. Please check details and availability with your Volkswagen Van Centre at the time of ordering. Screen representations do not allow exact reproduction of paint and upholstery colours.

Standard Optional
L | Caddy Life ML | Caddy Maxi Life

Wheels.

01 15" full wheel trim. Standard on Caddy Life 102PS.

02 15" Caloundra. 6J x 15 alloy wheels with 195/65 R15 tyres.

03 16" Bendigo. 6J x 16 alloy wheels with 205/55 R16 tyres.

04 16" Fortaleza. 6J x 16 alloy wheels with 205/55 R16 tyres. Standard on Caddy Maxi Life.

05 17" Canyon. Silver/Anthracite. 6J x 17 alloy wheels with 205/55 R17 tyres.



Audio and communications.



01



02



03



04

01 Composition Colour DAB+ radio system.
Standard on all Caddy Life models, the Composition Colour DAB+ radio system features a 5" TFT touch-screen colour display, USB port, Bluetooth®, SD card slot, AUX-IN interface, MP3 and WMA compatible CD drive, 4 x 20 watt output with six speakers and a dual tuner with PhaseDiversity for optimum radio reception.

02 Composition Media DAB+ radio system.
The optional Composition Media DAB+ radio system features an increased touch-screen size of 6.33" with proximity sensor, USB port, Bluetooth®, SD card slot, AUX-IN interface, MP3 and WMA compatible CD drive, 4 x 20 watt output with six speakers and a dual tuner with PhaseDiversity for optimum radio reception. App-Connect is available as an option for this system.

03 Discover Media satellite navigation system.
The optional Discover Media satellite navigation system builds on the strengths of the Composition Media DAB+ radio system by adding satellite navigation and a second integrated SD card slot compatible for map data. The system includes free updates for the pre-installed European maps through Volkswagen MapCare. App-Connect is available as an option for this system.

04 App-Connect.¹ Available as an option with the Composition Media DAB+ radio system or Discover Media navigation system. App-Connect allows you to operate special apps. The screen of your smartphone can be shown on the radio system's display.

¹ The 'App' control button on the optional Discover Media navigation system is only enabled when ordered in conjunction with the optional App-Connect system.

Design	Interior & infotainment	Seating configurations	Assistance systems	Caddy Life	Caddy Maxi Life	Caddy Life & Maxi Life standard equipment	Paint & upholstery	Wheels, audio & communications	Mobile online services	Technical information	Price list	Finance options	Finance, insurance, servicing & warranties
--------	-------------------------	------------------------	--------------------	------------	-----------------	---	--------------------	--------------------------------	------------------------	-----------------------	------------	-----------------	--

Mobile online services.

Optional App-Connect – Volkswagen apps.¹

Download special Volkswagen apps to your mobile or tablet, such as 'Shared Audio', 'Drive & Track', 'Call & Remind', 'My Guide' and 'Sound Journey' to make every journey more pleasant and interesting. The apps provide you with information about your driving behaviour, guide you to parking spaces in the vicinity, make detailed suggestions about exciting destinations – all taking into account the weather and traffic data.

Optional Car-Net Guide & Inform.²

Use Car-Net Guide & Inform to enhance your vehicle's optional Discover Media navigation system with online-based, up-to-date information services for greater convenience when travelling. For example, utilise real-time traffic information to avoid a sudden traffic jam, or refuel at the cheapest fuel station, or find a free parking space without the need for an infuriating search. Car-Net Guide & Inform helps you to reach your destination quickly and with the least amount of stress.

 **Online traffic information.**
Save time and avoid stress with real-time traffic information, enabling you to avoid traffic jams by dynamically adapting your route.

 **News.**
Subscribe to personalised news categories and use the news feeds to stay up-to-date.

 **Fuel stations.³**
View the fuel stations with the cheapest fuel prices in your immediate vicinity. Your vehicle's fuel type is automatically identified.

 **Online destination import.**
Conveniently plan your driving destinations from home using the customer portal and retrieve them using the navigation system.

 **Parking spaces.³**
Save time and view available parking options, along with prices and opening hours.

 **My special destinations.**
Use the customer portal to save your preferred destinations while at home and import these into your vehicle's navigation system.

 **Weather.**
Stay up-to-date with the latest weather information while on the move.

 **Vehicle status report.**
Retrieve the latest service information and error messages from your vehicle.

 **Online special destination search.**
Customised information about local services is sent directly to your touch-screen display.

 **Car-Net registration in a few easy steps:**

1. Create your personal account on the Car-Net website.
2. You will receive a registration code (PIN).
3. Enter your vehicle identification number (VIN).
4. Enter the PIN into your vehicle's navigation system.

1 Available as an option, App-Connect is only available in conjunction with the Composition Media DAB+ radio system or the Discover Media satellite navigation system. App-Connect comprises MirrorLink™, CarPlay™ and Android Auto™. The availability of these technologies can vary depending on the country in question. Please note that App-Connect is not currently supported by all mobile telephones on the market. Volkswagen is working closely with major smartphone producers to promote broader compatibility for App-Connect.

2 Available as an option, mobile online services (Car-Net) is only available in conjunction with the Discover Media satellite navigation system. You will also require a mobile device that is capable of acting as a mobile wireless hotspot. Car-Net services are only available with an existing mobile network contract or one to be agreed separately for this purpose between you and your mobile phone network provider and only within the respective mobile phone network coverage. Depending on your mobile phone tariff, receiving data from the internet may incur additional charges, particularly if you are using the phone abroad. Due to the amount of data needed when using Car-Net services, we strongly recommend signing-up to a data flat rate with your mobile phone provider. Use of Car-Net is governed in a separate agreement with Volkswagen AG online. After taking possession of the vehicle, you have 90 days in which to register the vehicle at www.volkswagen-commercial-vehicles-carnet.com. The availability of Car-Net services may vary depending on the country in question. These services are available for the duration of the contract term agreed and may be subject to changes in terms of content during the contract period. More detailed information on Car-Net is available at www.volkswagen-commercial-vehicles-carnet.com and from your Volkswagen Commercial Vehicles Van Centre. Contact your mobile network provider for information regarding your mobile network tariff.

3 Available at participating fuel stations and car parks.

Engine and gearbox data.

Engine specifications

	1.0TSI 102PS	2.0TDI 102PS
Engine type	Petrol, transverse, water-cooled, in-line, variable turbine geometry turbocharger with intercooler	Diesel, transverse, water-cooled, in-line, variable turbine geometry turbocharger with intercooler
Mixture preparation/injection method	Petrol, direct injection	Common-rail, direct injection
EU exhaust emission standard	EU6D Temp	EU6D Temp
Number of cylinders	3	4
Cubic capacity	999cc	1,968cc
Output, PS at rpm	102 at 5,000-5,500	102 at 2,900-4,000
Torque, max. Nm at rpm	175 at 2,000-3,500	250 at 1,300-2,800
Fuel tank capacity	55 litre	60 litre
AdBlue® capacity	-	9 litre
Diesel Particulate Filter [DPF]	-	●
5-speed manual gearbox	●	●
6-speed manual gearbox	-	-
6-speed dual clutch gearbox [DSG]	-	○
Front-wheel drive	●	●
Alternator	140 A	110 A
Battery	59 Ah (320 A)	61 Ah (330 A)

● Standard ○ Available - Not available

Fuel consumption, performance and emissions.

	Combined CO ₂ emissions,g/km ¹ , Max.	Combined CO ₂ emissions,g/km ¹ , Min.	Combined fuel consumption mpg ¹ , Max.	Combined fuel consumption mpg ¹ , Min.	Combined fuel consumption (ltr/100 km) ¹ , Max.	Combined fuel consumption (ltr/100 km) ¹ , Min.	Acceleration, secs 0 - 62 mph	Top speed, mph (where law permits)
Caddy Life								
1.0TSI 102PS 5-speed manual	169 - 159		38.2 - 40.4		7.4 - 7.0		12.1	107
2.0TDI 102PS 5-speed manual	152 - 144		48.7 - 51.4		5.8 - 5.5		12.9	107
2.0TDI 102PS 6-speed DSG	164 - 156		44.8 - 47.9		6.3 - 5.9		13.0	106
Caddy Maxi Life								
1.0TSI 102PS 5-speed manual	172 - 164		37.2 - 39.2		7.6 - 7.2		12.5	107
2.0TDI 102PS 5-speed manual	166 - 149		44.8 - 49.6		6.3 - 5.7		13.3	107
2.0TDI 102PS 6-speed DSG	166 - 161		44.8 - 46.3		6.3 - 6.1		13.4	106

¹ Figures shown are for comparability purposes; only compare fuel consumption and CO₂ figures with other vehicles tested to the same technical procedures. These figures may not reflect real life driving results, which will depend upon a number of factors including the accessories fitted (post-registration), variations in weather, driving styles and vehicle load. Data correct at 01.04.2020. Figures quoted are for a range of configurations (including non-UK) and are subject to change due to ongoing approvals/changes. Please consult your authorised Volkswagen Van Centre for further information.

Weights.

Engine/transmission	Gross vehicle weight, kg	Axle load limit, front/rear, kg	Trailer weight braked 12%/unbraked, kg	Gross train weight, kg	Unladen weight ¹ , kg	Payload ² , kg
Caddy Life						
1.0TSI 102PS 5-speed manual	2,160	1,100 / 1,200	1,200 / 680	3,200	1,524	636
2.0TDI 102PS 5-speed manual	2,275	1,150 / 1,200	1,500 / 730	3,650	1,638	637
2.0TDI 102PS 6-speed DSG	2,280	1,170 / 1,200	1,500 / 750	3,780	1,674	606
Caddy Maxi Life						
1.0TSI 102PS 5-speed manual	2,235	1,150 / 1,230	950 / 710	3,185	1,645	590
2.0TDI 102PS 5-speed manual	2,350	1,175 / 1,250	1,350 / 750	3,650	1,762	588
2.0TDI 102PS 6-speed DSG	2,380	1,200 / 1,250	1,400 / 750	3,780	1,798	582

¹ Unladen weight includes approximately 90% fuel load and 75kg for driver.

² Payload = gross vehicle weight minus unladen weight. Quoted weights are for vehicles with standard specification.

Unladen weight and payload may be influenced by trimline, factory options and Van Centre fitted accessories.

Roof load limit: 100kg. Trailer nose weight: 80kg.

Dimensions.

Caddy Life.

Wheelbase		2,682
Load compartment	length	1,353
	width	1,161
	width between wheel arches	1,136
	height	1,226
	load volume (seats in place)	2 seats: 3,200 litres 5 seats: 918 litres 7 seats: 190 litres
load length (seats in place)	2 seats:	1,781
	5 seats:	1,095
	7 seats:	224
Side sliding door	width	701
	height	1,084
Tailgate	width	1,183
	height	1,127
Turning circle (wall to wall)		11.1m

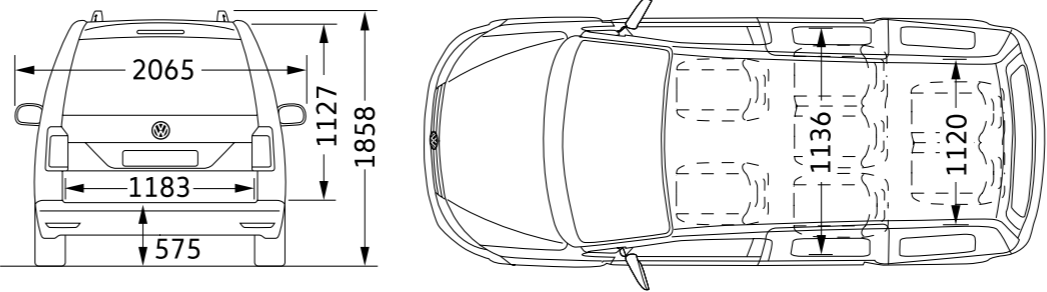
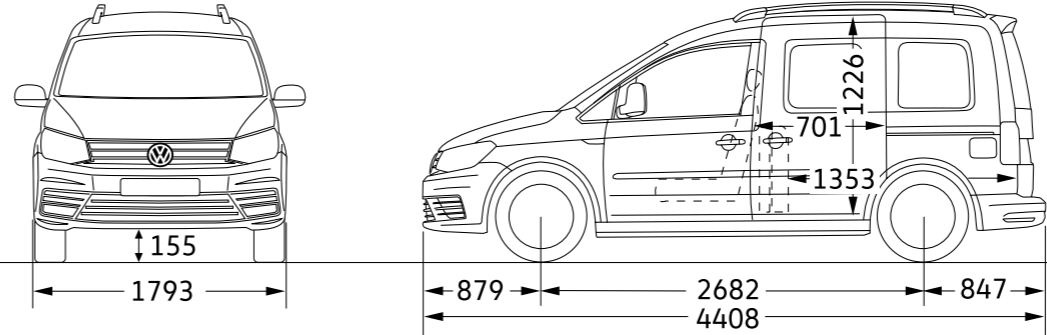

Caddy Maxi Life.

Wheelbase		3,006
Load compartment	length	1,823
	width	1,121
	width between wheel arches	1,120
	height	1,233
	load volume (seats in place)	2 seats: 4,130 litres 5 seats: 1,650 litres 7 seats: 530 litres
load length (seats in place)	2 seats:	2,250
	5 seats:	1,566
	7 seats:	644
Side sliding door	width	701
	height	1,084
Tailgate	width	1,183
	height	1,127
Turning circle (wall to wall)		12.2m

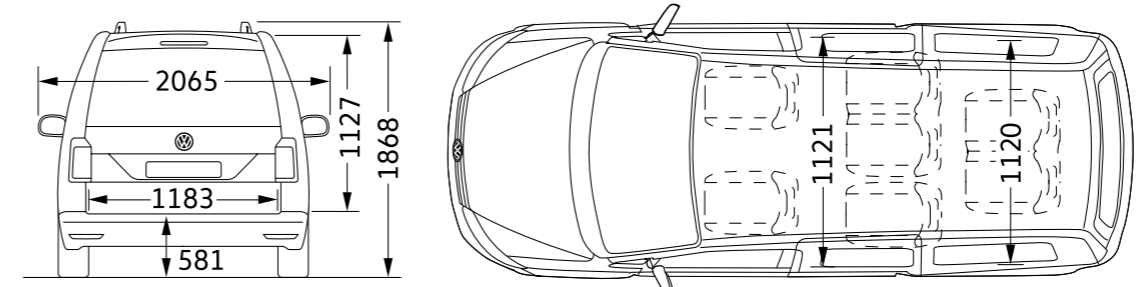
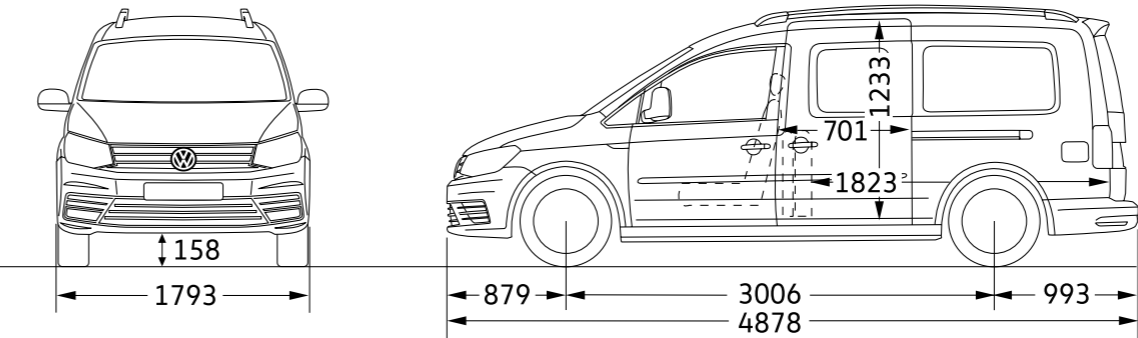

Please note: Vehicle drawings are not to scale. All dimensions in millimetres (mm), unless otherwise stated. The height measurements listed may vary by ± 50mm depending on model and equipment fitted.

Price list.



***Manufacturer's on the road (OTR) package.**

	Petrol	Diesel	Diesel
CO₂ emissions g/km	151-170	131-150	151-170
Delivery to Van Centre	£620.00	£620.00	£620.00
Number plates	£20.00	£20.00	£20.00
VAT	£128.00	£128.00	£128.00
First registration fee	£55.00	£55.00	£55.00
Vehicle excise duty (VED) 1st year	£540.00	£540.00	£870.00
Basic OTR price (exc. VAT)	£1,235.00	£1,235.00	£1,565.00
Total OTR price (inc. VAT)	£1,363.00	£1,363.00	£1,693.00

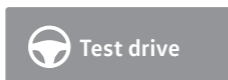
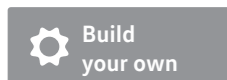

Model prices.

Trimline	Engine/transmission	Fuel type	Combined CO ₂ emissions g/km ¹	Basic exc. VAT	Total inc. VAT	Total RRP inc. OTR* ² exc. VAT	Total RRP inc. OTR* ² inc. VAT
Caddy Life Petrol	1.0TSI 102PS 5-speed manual	Petrol	159	£18,060.00	£21,672.00	£19,295.00	£23,035.00
Caddy Life Diesel	2.0TDI 102PS 5-speed manual	Diesel	144	£18,300.00	£21,960.00	£19,535.00	£23,323.00
	2.0TDI 102PS 6-speed DSG	Diesel	156	£19,960.00	£23,952.00	£21,525.00	£25,645.00
Caddy Maxi Life Petrol	1.0TSI 102PS 5-speed manual	Petrol	164	£20,540.00	£24,648.00	£21,775.00	£26,011.00
Caddy Maxi Life Diesel	2.0TDI 102PS 5-speed manual	Diesel	149	£20,780.00	£24,936.00	£22,015.00	£26,299.00
	2.0TDI 102PS 6-speed DSG	Diesel	161	£22,440.00	£26,928.00	£24,005.00	£28,621.00

* Please click here for more details on manufacturer's on the road (OTR) package.

Volkswagen Commercial Vehicles may change RRP's at any time (this includes where there are government changes in regulation and/or legislation). There may be a delay to any RRP displaying correctly on our materials. Always obtain prices from your chosen authorised Van Centre.

¹ Figures shown are for comparability purposes; only compare fuel consumption and CO₂ figures with other vehicles tested to the same technical procedures. These figures may not reflect real life driving results, which will depend upon a number of factors including the accessories fitted (post-registration), variations in weather, driving styles and vehicle load. Data correct at 01.04.2020. Figures quoted are for a range of configurations (including non-UK) and are subject to change due to ongoing approvals/changes. Please consult your authorised Volkswagen Van Centre for further information.

² From 1 April 2020, the official CO₂ emissions values used to calculate Vehicle Excise Duty (VED) charges will change for all passenger car registrations in the UK, due to a change in the method of testing. This will affect the Recommended 'On The Road' (ROTR) price you pay (in most circumstances, prices will increase). The Recommended 'On The Road' prices and any VED charges quoted reflect the VED charges which apply to vehicles registered after 1 April 2020. Choice of wheels and other options may affect fuel consumption, BIK and emissions data (which may affect the amount of VED payable and therefore the ROTR price). The price and charges you pay may differ from any prices or charges displayed or quoted before 1 April 2020.

Options.

Paint.	PR Code.	Life.		Maxi Life.	
		Basic exc. VAT	Total RRP inc. VAT	Basic exc. VAT	Total RRP inc. VAT
Solid. Candy White (B4B4), Cherry Red (4B4B).	As shown	○	○	○	○
Metallic. Acapulco Blue (2W2W), Blackberry (COCO), Chestnut Brown (H4H4), Fortana Red (I9I9), Indium Grey (X3X3), Mojave Beige (1B1B), Reflex Silver (8E8E), Sandstorm Yellow (9U9U), Starlight Blue (3S3S), Viper Green (6B6B).	As shown	£440.00	£528.00	£440.00	£528.00
Pearl effect. Deep Black (2T2T).	As shown	£440.00	£528.00	£440.00	£528.00
Upholstery.					
Seat trim covers and armrests in Mesh Leatherette.	ZS2	£60.00	£72.00	£60.00	£72.00
Interior trim colour.					
Titanium Black/Titanium Black – Titanium Black/Black. Seats in Titanium/Dashboard upper in Titanium Black – lower in Titanium Black/Floor covering in Black.		●	●	●	●
Titanium Black-Blue/Titanium Black – Titanium Black/Titanium Black. Seats in Titanium Black-Blue/Dashboard upper in Titanium Black – lower in Titanium Black/Floor covering in Black.		●	●	●	●
Titanium Black-Moon Rock/Titanium Black – Moon Rock/Titanium. Seats in Titanium Black-Moon Rock/Dashboard upper in Titanium Black – lower in Moon Rock/Floor covering in Black.		●	●	●	●
Seating.					
Deletion of 3rd row of seats. Includes deletion of seat preparation.	ZJ3	-	-	○	○
Heated driver and front passenger seats.	4A3	£260.00	£312.00	£260.00	£312.00
Height adjustment for driver and front passenger seats with drawers under front seats.	ZH3	£135.00	£162.00	£135.00	£162.00
Seats – 3rd row seats deleted.	ZJ4	-	-	○	○

● Standard – Not available ○ At no extra cost Where additional equipment is required by chosen options, additional equipment will be charged at the prices shown.

Volkswagen Commercial Vehicles may change RRP's at any time (this includes where there are government changes in regulation and/or legislation). There may be a delay to any RRP displaying correctly on our materials. Always obtain prices from your chosen authorised Van Centre.

Options (continued).

Wheel and tyres.	PR Code.	Life.		Maxi Life.	
		Basic exc. VAT	Total RRP inc. VAT	Basic exc. VAT	Total RRP inc. VAT
15" Steel wheels with full wheel covers. Weight optimised.	1NN	●	●	-	-
16" Bendigo alloy wheels. 6J x 16 205/55 R16 94H.	ZRD	£940.00	£1,128.00	○	○
16" Fortaleza alloy wheels. 6J x 16 205/55 R16 94H.	ZC6	-	-	●	●
17" Canyon alloy wheels, Anthracite. 6J x 17 205/50 R17 93H.	ZC7	-	-	£625.00	£750.00
Wheel and tyre accessories.					
Delete spare wheel.	1G0	○	○	○	○
Tyre mobility kit in lieu of spare wheel. Includes 12V compressor and tyre sealant.	1G8	○	○	○	○
Audio and communications.					
App-Connect. Only in combination with Discover Media navigation system at an additional cost.	9WT	£140.00	£168.00	£140.00	£168.00
Composition Media DAB+ radio system with 6.33" touch-screen.	Z46	£275.00	£330.00	£275.00	£330.00
Discover Media navigation system. Includes Guide and Inform, SD card maps.	Z50	£750.00	£900.00	£750.00	£900.00

● Standard - Not available ○ At no extra cost Where additional equipment is required by chosen options, additional equipment will be charged at the prices shown.

Volkswagen Commercial Vehicles may change RRP's at any time (this includes where there are government changes in regulation and/or legislation). There may be a delay to any RRP displaying correctly on our materials. Always obtain prices from your chosen authorised Van Centre.

Options (continued).

Driver assistance.	PR Code.	Life.		Maxi Life.	
		Basic exc. VAT	Total RRP inc. VAT	Basic exc. VAT	Total RRP inc. VAT
Adaptive Cruise Control (ACC) including speed limiter.	8T7/8T8	£255.00	£306.00	£255.00	£306.00
Front Assist including City Emergency Braking System with Adaptive Cruise Control (ACC). Only in combination with Adaptive Cruise Control (ACC) including speed limiter (8T7) at an additional cost.	6K3	○	○	○	○
High Beam Assist. Only in combination with Discover Media navigation system (Z49).	8G1	£135.00	£162.00	£135.00	£162.00
Parking sensors, rear.	7X1	£290.00	£348.00	£290.00	£348.00
Parking sensors – front and rear with Park Assist. Only in combination with Discover Media navigation system (Z49).	7X5	£615.00	£738.00	£615.00	£738.00
Parking sensors – front and rear with rear-view camera and Park Assist. Only in combination with Discover Media navigation system (Z49).	7X6	£840.00	£1,008.00	£840.00	£1,008.00
Parking sensors – rear with rear-view camera. Only in combination with a tailgate.	7X7	£500.00	£600.00	£500.00	£600.00
Power steering with mobility aid.	1N5	£75.00	£90.00	£75.00	£90.00
Packages.					
Exterior mirrors – electrically adjustable and heated.	6XE	£135.00	£162.00	£135.00	£162.00
Headlights – Bi-xenon with separate LED daytime running lights.	PL8	£690.00	£828.00	£690.00	£828.00
Heating and ventilation.					
Air conditioning – manual in the cab.	KH6	●	●	●	●
Air conditioning – 2-zone Climate control in the cab.	ZK5	£500.00	£600.00	£500.00	£600.00
Windows.					
Fixed window on driver side in driver compartment.	4DE	-£95.00	-£114.00	-£95.00	-£114.00
Fixed window on passenger side in passenger compartment.	4EE	-£95.00	-£114.00	-£95.00	-£114.00
Privacy glass, rear.	QC1	£165.00	£198.00	£165.00	£198.00

● Standard – Not available ○ At no extra cost Where additional equipment is required by chosen options, additional equipment will be charged at the prices shown.

Volkswagen Commercial Vehicles may change RRP's at any time (this includes where there are government changes in regulation and/or legislation). There may be a delay to any RRP displaying correctly on our materials. Always obtain prices from your chosen authorised Van Centre.

Finance made simple.

As dedicated to finance as we are to your new Caddy Life.

Learn more about our range of finance products to find a finance package that suits your budget.

Alternatively, 'Click on' the Offers & Finance button above to find out more about our latest offers to help your business thrive.

Cost of your vehicle

Deposit
As little as one monthly repayment

Monthly repayments
Spread across 18 to 49 months

Optional final payment
You have three choices at the end of your agreement



Own

Hire

Cost of your vehicle

Deposit
As little as one monthly repayment

Repayments
Spread across 12 to 60 months



Own

Cost of your vehicle

Deposit
As little as one monthly repayment

Rental repayments
Spread across 12 to 48 months

Final 'balloon' repayment



Own

Solutions Personal Contract Plan
Not sure if you want to own or hire? Make the decision later. Pay monthly payments for the length of your agreement. At the end you can decide to keep (once all payments have been made), upgrade or return the vehicle.

Hire Purchase
Make all the regular monthly payments. At the end the vehicles is yours.

Lease Purchase
Make lower monthly payments by deferring an amount until the end. Once paid the vehicle is yours.

Cost of your vehicle

Initial rental
As little as one rental repayment

Rental repayments
Spread across 12 to 60 months



Hire

Cost of your vehicle

Initial rental
As little as one rental repayment in advance

Rental repayments
Spread across 12 to 60 months



Hire

Cost of your vehicle

Initial rental
As little as one rental repayment in advance

Rental repayments
Spread across 12 to 48 months

Final 'balloon' repayment
You have two options at the end of your agreement



Hire

Contract Hire
Pay fixed monthly rentals to hire the vehicle. Look after it so at the end you can return it hassle free.

Finance Lease (full pay out)
Pay monthly rentals to hire the vehicle. At the end you have two options. Sell the vehicle and receive a percentage of the sale proceeds. Or retain the use of your vehicle by paying a reduced annual rental.

Finance Lease (balloon repayment)
Pay monthly rentals to hire the vehicle. At the end you have two options. Sell the vehicle to settle the outstanding amount and receive any excess sale proceeds. Or pay the 'balloon' payment and retain the use of your vehicle by paying a reduced annual rental.

Finance subject to status. Available to 18s and over in the UK only. Terms and Conditions apply. Volkswagen Commercial Vehicle Financial Services.

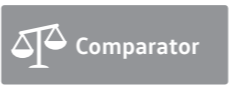
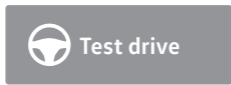

Finance, insurance, servicing and warranties.

Finance and insurance.¹

When it comes to paying for your van, we've got options including Contract Hire and Finance Lease, or Hire Purchase. We can also offer you competitive insurance with lots of features and benefits as standard, including our 3 Year Fixed Price commitment.

A choice of packages.²

Whether you prefer to lease your vehicles, with none of the concerns of ownership and the freedom to change models easily, or purchase outright to own the vehicle that's perfect for your business, we're here to help you consider your options.

You can go flexible, by choosing a payment plan that suits your finances, with options to reduce your monthly costs and your repayment period. Or choose a fixed monthly price that allows you to budget confidently for the longer term.

You can even include your road tax and servicing costs to arrive at one simple, all-inclusive payment. For more information, pick up a finance brochure, or ask at your Van Centre.

Volkswagen Car Insurance.³

Complimentary Drive Away Insurance

Every new and used Volkswagen comes with five days' complimentary Drive Away Insurance, so you can enjoy your new vehicle from day one. We will also provide you with a quote, giving you the option to purchase annual cover that comes with a 3 Year Fixed Price commitment; so you can relax knowing that if nothing changes over the next three years, the cost of your car insurance won't increase.

Subject to eligibility. Five days' Drive Away Insurance cannot be used in conjunction with any other insurance offer.

Annual insurance with a 3 Year Fixed Price commitment

Comprehensive insurance to offer you maximum convenience with minimum hassle – just as you'd expect.

Because we value your loyalty, you can benefit from the Volkswagen 3 Year Fixed Price commitment, so you can relax, knowing the cost of your car insurance won't increase each year. The price will only change if your circumstances do.

Cover runs for twelve months at a time and you'll receive a renewal notice confirming your fixed price for the following year. With Volkswagen Car Insurance, you're not tied in for the three years, so if you decide you no longer want cover, you can simply let us know before your cover renews.

Enjoy peace-of-mind and complete convenience and relax in the knowledge you have a policy tailored specifically for your Volkswagen.

With Volkswagen Car Insurance, you can enjoy the following benefits as standard:

- 3 Year Fixed Price commitment
- Volkswagen Approved Repairs carried out by Volkswagen Approved Technicians using only Volkswagen Genuine Parts[®] and paints (excludes windscreen claims)
- Guaranteed courtesy car whilst yours is in for repair
- Windscreen cover
- Uninsured driver promise (providing we have the car registration, make, model and driver details)
- Personal accident cover
- Personal belongings cover (excludes loss of money)
- Child seat replacement

How Volkswagen 3 Year Fixed Price Car Insurance works

When you take out Volkswagen Car Insurance, your premium will be fixed for two consecutive renewals, providing you choose to renew cover annually.

The price will only change if one or more of the following happens:

- if you or a named driver gain a motoring conviction or make a claim (excluding windscreen claims) after your policy has started
- if you make an amendment to your policy, such as changing your car or address, the revised premium will be fixed for the remaining renewal periods
- if the price of optional additional products and/or Insurance Premium Tax changes.

For more information or to get a quote, call us on: **0345 877 6464**

We're available Monday to Friday 8am-8pm and Saturday 9am-5pm.

Alternatively, visit: www.insurewithvolkswagen.co.uk

Volkswagen Commercial Vehicle GAP Insurance.⁴

If your Volkswagen Commercial Vehicle is written off, your motor insurer will usually settle your claim based on the current market value of your vehicle. This could be substantially less than the original value of your vehicle.

Volkswagen Commercial Vehicle GAP (also known as 'Guaranteed Asset Protection') Insurance helps to bridge the payment gap to get you back in a new Volkswagen Commercial Vehicle. Whether you purchase, finance, lease or hire your vehicle, Volkswagen Commercial Vehicle GAP Insurance is available and can be arranged up to 60 days after you have collected your new or used vehicle.

For more information about Volkswagen Commercial Vehicle GAP Insurance, visit: www.insurewithvvcv.co.uk/gap-insurance

Servicing and support.

We're here to keep your business moving, with our range of three award-winning⁵ servicing and maintenance options, as well as free Roadside Assistance. Some exclusions apply.

For more detail, please visit: www.volkswagen-vans.co.uk/aftersales

Fixed cost maintenance.

This option is available for vehicles that are less than twelve months old and have covered less than 10,000 miles. It makes budgeting easier by splitting the cost of servicing into fixed monthly payments – whether you want Service only; Service and Maintenance; or Service, Maintenance and Tyres.

Fixed price servicing.⁶

If you can pay for more than one service upfront, we'll help by reducing your costs. Buy two upfront and you'll receive one interim and one full service at a discounted rate. Buy four and you'll receive two interim and two full services, with your next MOT also included. You can also spread the cost with monthly payments, helping you budget⁷.

Pay on demand.

If you're looking for freedom and flexibility with your servicing, it's good to know we're ready when you are. So with our third option, you can choose to pay for your services as and when you need them, with our National Service Pricing. Ask your Van Centre for an up-to-date pricing guide.

Roadside Assistance.

We understand the need to keep you mobile. That's why all new vans come with three-year, unlimited mileage roadside cover. Should the unexpected happen, one call gets you straight through to a team trained to help you through any breakdown or accident. Supporting you every day will be a team of vehicle technicians, fully-trained by Volkswagen and carrying the latest diagnostic equipment, specialist tools and parts.

Assistance benefits include:

- Assistance at home, by the roadside or place of work.
- Recovery to your preferred location.
- Onward travel, for you and your cargo.
- Cover 24 hours a day, 365 days a year.
- Free cover for three years (on new vehicles).
- Unlimited mileage.
- European cover.
- Option to extend cover beyond three years.

Warranties.

You can count on us long after you purchase your Caddy Life, thanks to its comprehensive three-year, 100,000 mile warranty. You choose Volkswagen because your business depends on it, year in, year out. While your Caddy Life is under warranty, we'll fix any defect in manufacture or workmanship free of charge, even if you purchase and service the vehicle at different Van Centres. Some exclusions apply and the vehicle must be cared for using the guidance in your owner's manual.

For more detail, please visit: www.volkswagen-vans.co.uk/aftersales.

Extended warranty.

You can also extend your warranty beyond the three-year, 100,000 mile period, choosing either Comprehensive or Major Component cover, as a one-off or monthly payment.

For more detail of cover levels, along with terms and conditions, please visit: www.volkswagencvwarranty.co.uk where you'll also be able to obtain a quote and purchase an extended warranty.

Paint and body warranty.

Your Caddy Life's exterior paintwork is covered against manufacturing defects for a period of three years, while its body sections and panels are covered against rusting through from the inside for twelve years. Some exclusions apply and the vehicle must be cared for using the guidance in your owner's manual.

The Van Centre network.

Our **dedicated Van Centre network** is at the core of everything we do and is always there to help. As a separate brand within the Volkswagen Group, it makes sense to make use of your nearest Van Centre – it's full of experts who understand your vehicle better than anyone else and can help you to get the most out of it.

Over **65 Van Centres** and **30 Authorised Repairers**, means you're only around 45 minutes on average from our door.

1 Volkswagen Commercial Vehicles Insurance and Volkswagen Commercial Vehicle Financial Services are trading names of Volkswagen Financial Services (UK) Limited, Brunswick Court, Yeomans Drive, Blakelands, Milton Keynes MK14 5LR, which is authorised and regulated by the Financial Conduct Authority (FCA). Registered in England and Wales number: 2835230. Volkswagen Financial Services (UK) Limited financial services register number is 311988.

2 An offer of finance depends on certain conditions. Finance subject to status. Available to 18s and over. Terms and conditions apply. Volkswagen Commercial Vehicle Financial Services.

3 Volkswagen Car Insurance is underwritten by U K Insurance Limited. Calls may be recorded. Volkswagen Financial Services is a trading name of Volkswagen Financial Services (UK) Limited ('VWFS UK'), registered in England and Wales number: 2835230. Registered office: Brunswick Court, Yeomans Drive, Blakelands, Milton Keynes MK14 5LR. Volkswagen Insurance Service (Great Britain) Limited is an appointed representative of VWFS UK. VWFS UK is authorised and regulated by the Financial Conduct Authority, VWFS UK and U K Insurance Limited are not part of the same corporate group.

4 Volkswagen Commercial Vehicle GAP Insurance is administered by Abraxas Insurance Administration Services and underwritten by MAPFRE Asistencia Compañía Internacional de Seguros y Reaseguros, S.A. ('MAPFRE'). VWFS UK is not part of the same corporate group as MAPFRE and Abraxas Insurance Administration Services Limited.

5 Business Vans Awards 2014 and 2015: Best Service Package for Van Owners.

6 Class 4 MOT only. This option is available to all new and used vehicles up to seven years old with no mileage restrictions.

7 Pay monthly option eligible on vehicles with under 200,000 miles at point of activation.

Design	Interior & infotainment	Seating configurations	Assistance systems	Caddy Life	Caddy Maxi Life	Caddy Life & Maxi Life standard equipment	Paint & upholstery	Wheels, audio & communications	Mobile online services	Technical information	Price list	Finance options	Finance, insurance, servicing & warranties
--------	-------------------------	------------------------	--------------------	------------	-----------------	---	--------------------	--------------------------------	------------------------	-----------------------	------------	-----------------	--

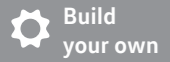

Build
your own



Find a
Van Centre



Test drive



Offers &
Finance



Conversions



Comparator



The Caddy Life

This brochure supersedes all previous publications.

Issue: 1 May 2020

www.volkswagen-vans.co.uk

Please note: Screen technology does not allow exact reproduction of the paint and upholstery colours. Some of the vehicles shown are European specification and may be fitted with optional equipment or accessories that are available at extra cost, or do not reflect current specification. All data and specifications are in accordance with information available at the time of publication and are subject to change without notice. Vehicles not currently in UK stock and customer order vehicles may take a number of weeks for delivery. Certain combinations of vehicle specifications and factory-fitted options are not compatible and therefore all orders received are subject to confirmation. Models, factory fitted-options and paint and upholstery options are subject to availability. Please check details and availability with an authorised Volkswagen Van Centre at the time of ordering.