

# Transit



*Ford*

# Meet the Transit Commercial Fleet

Welcome to the award-winning Ford Transit Commercial Range. Renowned for capability, dependability, safety, efficiency and car-like drive and comfort, the comprehensive Transit line-up is built to get the job done.



Transit Custom Sport 320S SWB shown in Blue Metallic



Transit 410L Bus shown in Frozen White



Transit 470E Single Cab Chassis with after-market tray shown in Frozen White



Above: Transit Custom 340L LWB shown in Frozen White

Front Cover (Left to Right): Transit 350L LWB FWD Van in Frozen White, Transit Custom Sport 320S SWB in Orange Glow, Transit Custom Double Cab in Van 340L LWB in Magnetic



Transit 350L LWB FWD Van shown in Moondust Silver

Transit 350L LWB FWD Van interior shown with Optional Satellite Navigation.

## Welcome to the world of Ford connectivity

Every vehicle in the Transit Commercial Range will arrive fitted with an embedded modem known as FordPass Connect. Using the FordPass App on your smartphone<sup>17</sup>, you can locate your vehicle, lock and unlock the doors, and even start the engine remotely to heat or cool the cabin to the last known setting.<sup>18</sup>

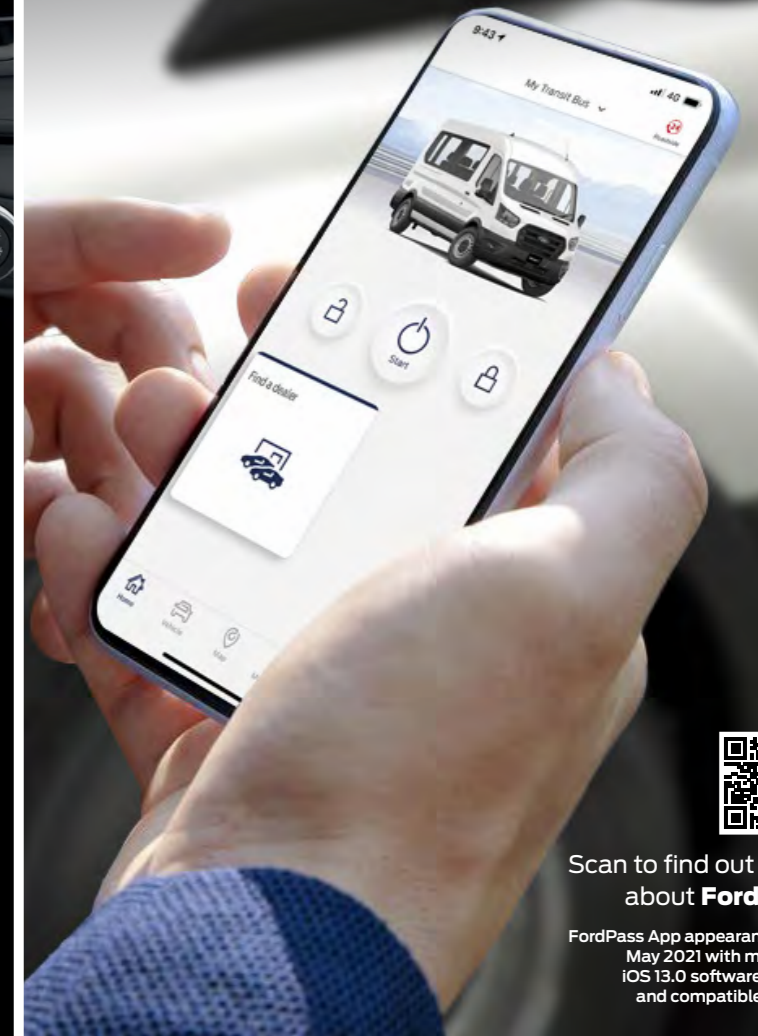

Scan to find out more about **FordPass**

FordPass App appearance as at May 2021 with minimum iOS 13.0 software or later and compatible device.

# The van that can

Delivering bold design, the versatility to take on tight streets and enough load space to keep your business moving, the Transit Commercial range is built tough. The advanced 2.0L EcoBlue diesel engine delivers an impressive 125kW of power and 390Nm of torque in Transit Custom, Van, Bus & Cab Chassis models, and up to 136kW and 405Nm in Transit Custom Sport models. Along with the latest smart technology, every Transit Commercial Vehicle is powerful, capable and intelligent, ready to become your next mobile office.

## Advanced safety

### Adaptive Cruise Control<sup>13</sup>

Adjusts to the flow of traffic, slowing down when it senses a vehicle in front and returning to your pre-set speed once it clears.

### Autonomous Emergency Braking (AEB) with Pedestrian Detection<sup>13</sup>

Detects if the car in front stops unexpectedly, or a pedestrian steps onto the road, and can automatically apply the brakes if you don't.

### Lane Keeping Aid with Lane Departure Warning<sup>13</sup>

Monitors road markings to detect if you unintentionally move out of your lane, and vibrates your steering wheel to warn you.

### Auto Wipers / Headlights (inc. High Beam)<sup>13</sup>

Automatically turns high beams on and off depending on light levels and surrounding vehicles. Auto Wipers automatically turn on and adjust speed, depending on how heavy the rain is.

### Reverse Camera & Rear Cross Traffic Alert<sup>13, 15</sup>

Park with confidence. When reversing, Rear Cross Traffic Alert can detect approaching vehicles, or other hazards, and warn you.

### Blind Spot Information System (BLIS)<sup>13, 15</sup>

If another vehicle enters your blind spot, the system activates a warning indicator light in the side mirror.

### Tyre Pressure Monitoring System (TPMS)<sup>16</sup>

Available on Transit Custom Sport models, it will notify you if one of your tyres is significantly under-inflated.

### MyKey™

Program restricted driving mode settings (like top speeds) into your keys, encouraging responsible driving for those who may use the van.

## Peace of mind inside and out

### Six airbags standard

Every Transit has airbags positioned at the front, on both sides and at the head to protect the driver and front passengers.

### Room for the whole crew

With up to 6 seats available on the 340L Custom Double Cab and 7 seats on the Double Cab Chassis, Transit is the perfect solution for moving crew and cargo.

## Colour Range

### Entire Transit Range



Frozen White

### Additional Transit Custom colours



Magnetic\*

### Additional Transit Custom Sport colours



Orange Glow\*

### Additional Transit Bus colour



Agate Black\*



Moondust Silver\*



Agate Black\*



Blue Metallic\*

### 100+ Special Vehicle Option (SVO) Paint options\*



## Notes

\* Prestige Paint is an option that incurs an additional charge. SVO Paint not available on Transit Custom Sport models.



### SYNC® 3 with Apple CarPlay™ Android Auto™<sup>1, 2</sup>.

Our fully integrated Sync® 3 system seamlessly connects compatible smartphones so you never miss a beat. Get to your next worksite with the optional Satellite Navigation system,<sup>3</sup> make hands free calls and listen to text messages.



### Transit Custom Sport

Delivering an upgraded 136kW/405Nm of torque, Transit Sport comes with 17" machine alloy wheels, sports body kit and unique stripes. Driver comfort is enhanced with partial leather seat trims, 8" touch screen & standard satellite navigation.



### Advanced EcoBlue Diesel Engine with optional Auto Transmissions<sup>4</sup>.

The high performance EcoBlue diesel engine is now available with 6-speed auto across the Transit Custom range and 10-speed auto for Transit Van, Bus and Cab Chassis models. Plus, save time and money with the 30,000km/12mth interval between services.



### Flexible cargo space and Load Area Protection<sup>5</sup>.

Transit maximises space and practicality, with up to 3.4m load length<sup>6</sup> in Transit Custom and up to 4.2m<sup>7</sup> in Transit Van. Protect cargo with a fixed bulkhead, sealed load floor, hardboard lining and multiple tie-down hooks.



### High roof

Sometimes you just need some extra height. With an optional high roof available for Transit Custom and Transit Van, expand your max cargo volume up to 8.3m<sup>8</sup> and up to 15.1m<sup>9</sup> respectively so you'll never need to compromise.



### Rear liftgate door and dual side load doors<sup>9</sup>.

All Transit vans come standard with barn doors, with the option of a rear liftgate door to let you load and unload even in the rain. And cargo is easily accessed from both sides with versatile dual side load doors!<sup>10</sup>



### Impressive towing ability

With up to 2,800kg<sup>11</sup> maximum towing capacity on Transit Custom and up to 3,500kg<sup>12</sup> on Transit Van and Cab Chassis models, every model includes impressive safety features like Trailer Sway Control, Side Wind Stabilisation and Load Adaptive Control.<sup>13</sup>



### Integrated Roof Racks<sup>14</sup>.

The Transit Custom's Integrated Roof Racks fold flat to give you increased vehicle height clearance, and reduce wind noise and fuel consumption when not in use. Lightweight and aerodynamic, the sturdy roof base allows you to carry a range of loads easily.



### Transit Bus

The 410L Transit Bus comes with 12-seats, a versatile 10-speed automatic transmission and a power-operated left-hand side loading door. The optional high roof comes with overhead storage and LED reading lamps for your passengers.



# Ford Service Benefits

## Our commitment to you

Convenience. Reliability. And no nasty surprises. That's what service should be. And that's exactly what Ford promises when you have your vehicle serviced. Feel at ease knowing that your vehicle is being serviced by factory trained technicians using specialised diagnostic equipment. After all, nobody knows your Ford better than we do. Speak to your participating Ford Dealer today about how we can help you make the most out of your vehicle experience – **Now that's what service should be.**



Service Loan Car<sup>1</sup>



Brakes Price Promise<sup>1</sup>



Service Calculator<sup>1</sup>



Sat Nav Map Updates<sup>1</sup>



National Roadside Assistance & Auto Club Lifestyle Membership<sup>1</sup>



Low Price Tyre Guarantee<sup>1</sup>



Vehicle Health Report



Genuine Ford Parts



Peace Of Mind Service Inspection



Online Service Bookings



## \$399 Service

For a maximum of four A or B scheduled services up to 4 years/120,000kms

Feel at ease knowing that when you purchase a new Transit or Transit Custom, for eligible customers, the most you will pay is \$399 for items listed in the first four A or B standard services for up to 4 years or 120,000kms, whichever comes first<sup>2</sup>.



## 5 Year Warranty

As a Ford owner you will receive a Five Year / Unlimited Kilometre Ford Express New Vehicle Warranty with your purchase<sup>3</sup>. For details about this warranty please visit: [www.ford.com.au/owners/warranties](http://www.ford.com.au/owners/warranties)



## Low Price Tyre Guarantee<sup>1</sup>

We'll match competitors' prices on selected tyres we stock.



MICHELIN



GOODYEAR



BRIDGESTONE



DUNLOP



Continental



PIRELLI



BFGoodrich<sup>®</sup>



FIRESTONE



HANKOOK  
driving emotion



GENERAL TIRE

1. Available at participating Dealers. See [www.ford.com.au/owners/service/](http://www.ford.com.au/owners/service/) for full terms and conditions. 2. Available at participating Ford Dealers on 2021.25MY Transit onwards and 2021.25MY Transit Custom onwards vehicles first purchased by a Private or Blue Fleet customer or as a dealer demonstrator/service loaner (CCLV) vehicle excluding vehicles purchased under Ford's Privilege Club or Ford's Dealership Employee Program. Offer valid for a maximum of four A or B scheduled services up to 4 years/120,000kms (whichever occurs first) excluding any Additional Service Items, as per the Customer Assistance Warranty and Service Guide, commencing on the date of delivery to original owner except for demonstrator/service loaner (CCLV) vehicles, in which case it commences on the date it was first registered by a Ford Dealer. A or B Scheduled Service items (and Additional Scheduled Maintenance Items) are set out in the Customer Assistance and Warranty Guide with the vehicle. See [www.ford.com.au/owners/service/t-and-c](http://www.ford.com.au/owners/service/t-and-c) for full terms and conditions. 3. Warranty conditions apply. 5 year/unlimited km Ford Express New Vehicle Warranty applies to new, demonstrator and service loaner vehicles delivered from 1 May 2018. Our goods come with consumer guarantees that cannot be excluded under the Australian Consumer Law. Our warranty does not limit and may not exceed your rights under those guarantees.

This brochure details specifications and features of the 2021.75MY Transit Range. Some driver assistance features and safety features described in this brochure are designed to function using sensors, whose performance may be affected under certain weather or environmental conditions. Not all features will be available on the entire 2021.75MY Transit Range. Please visit our website [www.ford.com.au](http://www.ford.com.au) for more information.

This brochure is designed to provide you with a general introduction to the Ford Products (including available optional equipment) referred to, and should be read in conjunction with the latest specification sheet. Image and illustrations are for information purposes and are indicative only. Because of changes in conditions and circumstances Ford\* reserves the right, subject to all applicable laws, at any time, at its discretion, and without notice, to discontinue or change the features, designs, materials, colours and other specifications and the prices of its products, and to either permanently or temporarily withdraw any such products from the market without incurring any liability to any prospective purchaser or purchasers. The latest specification sheet should be referred to for information on the availability, ordering and use of features and optional equipment. Always consult an authorised Ford Dealer for the latest information with respect to features, specifications, prices, optional equipment and availability before deciding to place an order.

\*FORD MOTOR COMPANY OF AUSTRALIA PTY LIMITED. (A.B.N. 30 004 116 223) Registered Office: Level 1, 600 Victoria St, Richmond, Victoria 3121, Australia.  
2021.75MY Transit Custom - 2022MY Transit Brochure. December 2021. FMPMG0427.



Discover more at [ford.com.au](http://ford.com.au)

### Contact us

If you have any questions or concerns, please contact our Customer Relationship Centre on 13 FORD (13 3673) or email [foacust1@ford.com](mailto:foacust1@ford.com)

### Running a fleet?

Our Ford Fleet team is here to assist you in any way we can. Please call 1300 13 13 30 or email [askfleet@ford.com](mailto:askfleet@ford.com)

Click to request



Quote



Hot Deals



Test Drive

### Ford For Good

From supporting national causes to community volunteering, we take our social responsibility seriously. Find out more at [ford.com.au/about/community](http://ford.com.au/about/community)

# TRANSIT CUSTOM

2021.75MY Transit Custom

## Van load capacity and payload

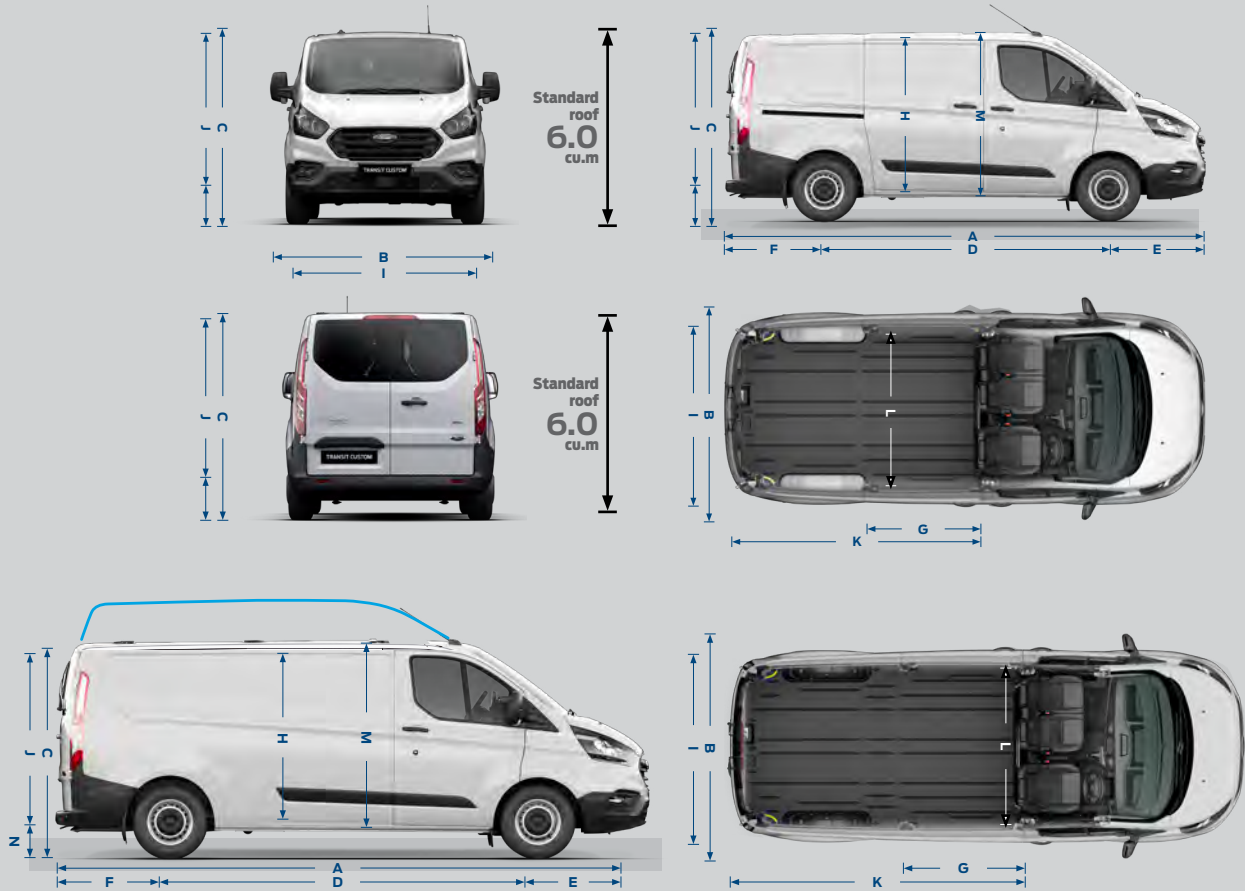

## Double Cab-in-van load capacity and payload

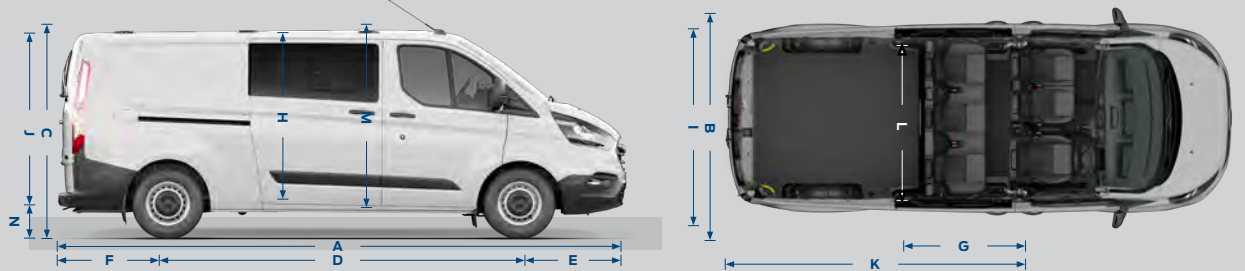

## Transit Custom Dimensions & Weights

Measurements Dimensions (mm)	Transit Custom 340S SWB	Transit Custom Sport 320S SWB	Transit Custom 340L LWB	Transit Custom Sport 320L LWB DCiV	Transit Custom 340L LWB DCiV
A. Overall Length	4,973	4,973	5,340	5,340	5,340
B. Overall Width With Mirrors	2,272	2,272	2,272	2,272	2,272
C. Overall Height (Low Roof / High Roof)*	1,925 - 2,060 / 2,286 - 2,366	1,925 - 2,060 / -	1,922 - 2,039 / 2,285 - 2,343	1,922 - 2,039 / -	1,922 - 2,039 / -
D. Wheelbase	2,933	2,933	3,300	3,300	3,300
E. Front Of Vehicle To Front Wheel Centre	1,012	1,012	1,012	1,012	1,012
F. Rear Of Vehicle To Rear Wheel Centre	1,028	1,028	1,028	1,028	1,028
G. Side Door Entry Width	1,030	1,030	1,030	930	930

\* Height dimensions show a range from min. to max. of a fully laden, lowest payload vehicle to unladen highest payload vehicle. These illustrations are for guidance only. All dimensions (shown in mm) are subject to manufacturing tolerances and do not include additional equipment. VDA - This is the method used by the Verband der Automobilindustrie (VDA) in Germany. A VAD figure is determined by filling the load space with 'litre' blocks, each measuring 200x100x50mm. The blocks are then counted, and the numerical result is converted into cubic meters. The actual weight will always be subject to manufacturing tolerances which may result in payload variations between this guide and actual weight. If intending to load the vehicle close to the maximum payload, we suggest a margin of 5% to Kerb Mass figure to reduce risk of overloading.

# TRANSIT CUSTOM

2021.75MY Transit Custom

## Transit Custom Dimensions & Weights

Measurements Dimensions (mm)	Transit Custom 340S SWB	Transit Custom Sport 320S SWB	Transit Custom 340L LWB	Transit Custom Sport 320L LWB DCiV	Transit Custom 340L LWB DCiV
H. Side Load Door Entry Height	1,324	1,324	1,324	1,324	1,324
I. Rear Door/Tailgate Entry Width	1,404	1,404	1,404	1,404	1,404
J. Rear Door/Tailgate Entry Height (Low Roof / High Roof)	1,347 / 1,706	1,347 / -	1,347 / 1,706	1,347 / -	1,347 / -
K. Max. Load Space Length (Up to Bulkhead)	2,554	2,554	2,921	1,944	1,944
Max. Load Space Length (Includes Load Through Hatch)	3,037	3,037	3,404	1,944	1,944
L. Load Space Between Wheel Arches	1,351	1,351	1,351	1,351	1,351
M. Load Floor To Roof (Low Roof / High Roof)	1,406 / 1,778	1,406 / -	1,406 / 1,778	1,406 / -	1,406 / -
N. Rear Door Loading Height	511 - 564	511 - 564	513 - 536	513 - 536	513 - 536
Max Load Volume (with Bulkhead) (cu.m) (Low Roof / High Roof)	6.0 / 7.2	6.0 / -	6.8 / 8.3	4.4 / -	4.4 / -
Euro Pallet Capacity (1,200mm x 800mm)	3	3	3	2	2
<b>Measurements Weights &amp; Loads (kg)</b>					
Payload (Manual: Low Roof / High Roof Auto: Low Roof / High Roof)	1,387 / 1,353 1,339 / 1,305	- / - 1,046 / -	1,330 / 1,294 1,282 / 1,246	- / - 969 / -	- / - 1,149 / -
Gross Vehicle Mass	3,400	3,100	3,400	3,200	3,400
Maximum Kerb Weight (Manual: Low Roof / High Roof Auto: Low Roof / High Roof)	2,013 / 2,047 2,061 / 2,095	- / - 2,054 / -	2,070 / 2,106 2,118 / 2,154	- / - 2,231 / -	- / - 2,251 / -
Gross Combined Mass (Manual / Auto)	5,365 / 4,365	- / 4,100	5,365 / 4,365	- / 4,200	- / 4,365
Axle Plated Mass (Front / Rear)	1,625 / 2,015	1,600 / 1,640	1,750 / 2,015	1,725 / 1,725	1,750 / 2,015
Maximum Braked Towing Capacity (Manual / Auto)**	2,500 / 2,000	- / 1,750	2,800 / 1,850	- / 1,650	- / 1,800

\*\* When fitted with appropriate after-market tow bar and trailer brake controller. Towing capacity subject to regulatory requirements, towbar and vehicle design and towing equipment limitations. Further weight restrictions apply, please consult your authorised Ford Dealer and/or refer to the Owners Manual for guidance.

## Specifications 2021.75MY Transit Custom

	Transit Custom 340S SWB (Low Roof)	Transit Custom 340S SWB (High Roof)	Transit Custom 340L LWB (Low Roof)	Transit Custom 340L LWB (High Roof)	Transit Custom Sport 320S SWB (Low Roof)	Transit Custom Sport 320L LWB DCiV (Low Roof)	Transit Custom 340L LWB DCiV (Low Roof)
<b>Engine</b>							
2.0L EcoBlue Engine	S		S			S	S
Auto Stop/Start <sup>1</sup>	S		S			S	S
Power – Maximum (DIN)	125kW @ 3,500rpm		125kW @ 3,500rpm		136kW @ 3,500rpm		125kW @ 3,500rpm
Torque – Maximum (DIN), Valves	390Nm @ 1,500 - 2,000rpm, 16		390Nm @ 1,500 - 2,000rpm, 16		405Nm @ 1,500 - 2,000rpm, 16		390Nm @ 1,500 - 2,000rpm, 16
<b>Transmission</b>							
6-speed Manual	S		S		N/A	N/A	N/A
6-speed Automatic	O		O		S	S	S
<b>Fuel Economy &amp; Emissions</b>							
Fuel	Diesel		Diesel		Diesel		Diesel
Combined Fuel Economy (L/100km) – Manual/Automatic <sup>2</sup>	6.9 / 7.3		6.9 / 7.3		7.3		7.3
Fuel Tank Capacity (Litres)	70		70		70		70
AdBlue <sup>®</sup> Tank Capacity (Litres)	21		21		21		21
<b>Brakes</b>							
Front Disc Brakes	S		S		S		S
Rear Disc Brakes	S		S		S		S

S = Standard O = Factory Option that can be ordered before a vehicle is manufactured A = Accessory that can be added at any time P = Part of a Pack

<sup>1</sup> Auto Stop/Start will not occur in all situations. <sup>2</sup> Fuel consumption and emissions as per ADR 81/02 (combined cycle) and to be used for vehicle comparison purposes only. It is unlikely that this fuel consumption and emissions figure will be achieved in real world driving conditions. Actual fuel consumption and emissions will depend on many factors including the driver's habits, prevailing conditions and the vehicle's equipment, condition and use.



# TRANSIT CUSTOM

2021.75MY Transit Custom

## Specifications 2021.75MY Transit Custom

	Transit Custom 340S SWB		Transit Custom 340L LWB		Transit Custom Sport 320S SWB	Transit Custom Sport 320L LWB	Transit Custom 340L LWB
	(Low Roof)	(High Roof)	(Low Roof)	(High Roof)	(Low Roof)	DCiV (Low Roof)	DCiV (Low Roof)
<b>Suspension / Steering</b>							
Front – Independent MacPherson Struts, Variable Rate Coil Springs, Stabiliser Bar & Gas Pressured Shock Absorbers	S		S		S		S
Rear – Single Leaf Springs, Gas Pressurised Shock Absorbers	S		S		S		S
Power Assisted Steering	S		S		S		S
<b>Wheels &amp; Tyres</b>							
Wheel size / type – Standard	6.5" x 16" Steel wheels		6.5" x 16" Steel wheels		17" Alloy wheels		6.5" x 16" Steel wheels
Tyre Size	215/65 R16 109T		215/65 R16 109T		215/60 R17 107T		215/65 R16 109T
Turning Circle – Kerb to kerb (m)	11.6		12.8		11.8		13.0
Spare Wheel Type	Steel		Steel		Steel 17"		Steel
Rear Wheel Configuration	Single		Single		Single		Single
Front and Rear Mudflaps	S		S		S		S
<b>Safety</b>							
6 Airbags - Driver, Front Passenger, Front Side Curtain & Front Side Seat	S		S		S		S
Automatic Headlamps <sup>3</sup>	S		S		S		S
Automatic High Beam Control <sup>3</sup>	S		S		S		S
Autonomous Emergency Braking with Pedestrian Detection <sup>3</sup>	S		S		S		S
Dynamic Stability Control (DSC) incorporating Anti-Lock Break System <sup>3</sup>	S		S		S		S
Electronic Brakeforce Distribution (EBD) <sup>3</sup>	S		S		S		S
Emergency Brake Assist (EBA) <sup>3</sup>	S		S		S		S
Emergency Brake Light	S		S		S		S
Heated Windshield	S		S		S		S
Load Adaptive Control <sup>3</sup>	S		S		S		S
MyKey™	S		S		S		S
Rear Window Defroster	S		S		S		S
Roll Over Mitigation <sup>3</sup>	S		S		S		S
Traction Control System <sup>3</sup>	S		S		S		S
Trailer Sway Control <sup>3</sup>	S		S		S		S
Tyre Pressure Monitoring System (TPMS)	-		-		S		-
<b>Security</b>							
Perimeter Anti-Theft Alarm	S		S		S		S
Remote Keyless Entry - 2 Fobs	S		S		S		S
<b>Driver Assistance</b>							
Adaptive Cruise Control <sup>3</sup>	S		S		S		S
Automatic Rain-Sensing Wipers <sup>3</sup>	S		S		S		S
Blind Spot Monitoring System (BLIS) <sup>3</sup>	S		S		S		S
Driver Impairment Monitor <sup>3</sup>	S		S		S		S
Hill Launch Assist <sup>3</sup>	S		S		S		S
Lane Keeping Aid with Lane Departure Warning <sup>3</sup>	S		S		S		S
Rear Cross Traffic Alert <sup>3</sup>	S		S		S		S
Reverse Camera with Front and Rear Parking Sensors <sup>3</sup>	S		S		S		S
Side Wind Stabilisation <sup>3</sup>	S		S		S		S

S = Standard O = Factory Option that can be ordered before a vehicle is manufactured A = Accessory that can be added at any time P = Part of a Pack

<sup>3</sup>. Driver-assist features are supplemental and do not replace the driver's attention, judgment and need to control the vehicle. May not operate in some driving and road conditions (including at certain speeds) or adverse weather.

# TRANSIT CUSTOM

2021.75MY Transit Custom

## Specifications 2021.75MY Transit Custom

	Transit Custom 340S SWB		Transit Custom 340L LWB		Transit Custom Sport 320S SWB	Transit Custom Sport 320L LWB	Transit Custom 340L LWB
	(Low Roof)	(High Roof)	(Low Roof)	(High Roof)	(Low Roof)	DCiV (Low Roof)	DCiV (Low Roof)
<b>Interior Features</b>							
<b>Seating</b>							
Cloth Seat Trim	S		S			-	S
Driver 10-Way Manual Seat (Fore/Aft, Recline, Up/Down, Cushion Tilt, Lumbar Adjust)	S		S			-	S
Driver 10-Way Power Driver's Seat	-		-			S	-
Driver Arm Rest	S		S			S	S
Dual Front Passenger Fixed Seats with 2-way manual adjustment	S		S		S	-	S
Heated Driver and Passenger Seats <sup>4</sup>	S		S			S	S
Number of Seats	3		3		3	5	6
Partial Leather Seat Trim	-		-			S	-
Three Rear seating capacity	-		-		-	S	S
Under Seat Stowage Compartment (Passenger side)	S		S		S	-	S
<b>Comfort &amp; Convenience</b>							
2nd/3rd Row Courtesy Lamp	-		-		-	S	S
Air Conditioning - Manual Front Single Zone	S		S			S	S
Fold Down Tray Table	S		S		S	-	S
Instrument Cluster with 4.2" Colour Screen	S		S			S	S
Leather Wrapped Steering Wheel	S		S			S	S
Lighting - Dual Front Overhead	S		S			S	S
Power - 3 x 12V Sockets (Interior + Rear Cargo Area)	S		S			S	S
Power Front Windows (Auto Up/Down for Driver)	S		S			S	S
Sports interior trim (Gloss Black IP insert, Chrome Vent surrounds)	-		-			S	-
Tachometer	S		S			S	S
Telescopic and Tilt Adjustable Steering Column	S		S			S	S
Trip Computer with Digital Speedometer	S		S			S	S
<b>Storage &amp; Carrying</b>							
Bottle Holders - Two 2-Litre	S		S			S	S
Cup Holders - 2	S		S			S	S
Door Storage Pockets	S		S			S	S
DCiV Moulded Bulkhead	-		-		-	S	S
Dual Side Load Doors with 2nd Row Flip-Open Side Windows on LHS/RHS	-	-	-	-	-	S	S
Floor - Rubber (Front)	S		S			S	S
Full Width Bulkhead with Window and Load-Through Hatch	S		S		S	-	-
Integrated Roof Rack (130kg Capacity)	S	-	S	-		S	S
Kerbside Load Door	S		S		S	-	-
Load Area Compartment Light - Halogen	S		S			-	S
Load Area Compartment Light - LED	-		-			S	-
Load Area Tie Down Points (4)	-	-	-	-	-	S	S
Load Area Tie Down Points (8)	S		S		S	-	-
Load Area Protection Kit	S		S		S	-	-
Load Floor Lining	S		S			S	-
Locking Glove Box - With Lid & A4 Hanging File Storage Capability	S		S			S	S
Rear Twin Barn Door with Window (180° Opening)	S		S			S	S

S = Standard O = Factory Option that can be ordered before a vehicle is manufactured A = Accessory that can be added at any time P = Part of a Pack

4. Excludes middle seat.

# TRANSIT CUSTOM

2021.75MY Transit Custom

## Specifications 2021.75MY Transit Custom

	Transit Custom 340S SWB		Transit Custom 340L LWB		Transit Custom Sport 320S SWB	Transit Custom Sport 320L LWB	Transit Custom 340L LWB
	(Low Roof)	(High Roof)	(Low Roof)	(High Roof)	(Low Roof)	DCiV (Low Roof)	DCiV (Low Roof)
<b>Audio, Communications &amp; Instruments</b>							
2x USB Ports		S		S		S	S
4 Speakers (2 Woofers, 2 Tweeters)		S		S		S	S
8.0" Multi-functional Touchscreen Display		S		S		S	S
Apple CarPlay™ and Android Auto™ integration <sup>5</sup>		S		S		S	S
DAB+/AM/FM Radio		S		S		S	S
FordPass Connect - Embedded Modem <sup>6</sup>		S		S		S	S
Steering Wheel Mounted Audio Controls		S		S		S	S
SYNC@3 <sup>7</sup> with AppLink™		S		S		S	S
<b>Lights / Visibility</b>							
Bi-Xenon HID Headlamps with Static Bending & LED DTRL		-		-		S	-
Daytime Running Lamps (Halogen)		S		S		-	S
Front Fog Lamps		S		S		S	S
'Follow-Me-Home' Headlight Function		S		S		S	S
Front Variable Intermittent Wipers		S		S		S	S
Headlights (Halogen)		S		S		-	S
High Mounted Stop Light		S		S		S	S
Manual Headlight Levelling		S		S		S	S
Power Foldable, Electrically Operated Mirrors (with Side Indicators)		S		S		S	S
<b>Sports Kit</b>							
Body Coloured Bumper/Rear Bumper/ Bodyside Moulding		-		-		S	-
Body Coloured Mirrors		-		-		S	-
Sports Body Kit		-		-		S	-
Unique Body Stripe/Sport Decals		-		-		S	-
<b>Regular Production Options</b>							
Dual Side Load Doors (No Windows) <sup>8</sup>		O		O		O	-
Dual Side Load Doors (With Windows) <sup>8</sup>		O		O		O	-
Window on Side Load Door (LHS only) <sup>8</sup>		O		O		O	-
Rear Liftgate Style Door (in lieu of Twin Hinged) <sup>8</sup>		O		-		O	O
High Roof <sup>8</sup>		O		-		-	-
Prestige Paint <sup>8</sup>		O		O		O	O
Special Vehicle Options (SVO) Paint <sup>8</sup>		O		O		N/A	O
Satellite Navigation with Traffic Message Channel & Integrated Voice Control <sup>8</sup>		O		O		S	O

S = Standard O = Factory Option that can be ordered before a vehicle is manufactured A = Accessory that can be added at any time P = Part of a Pack

5. Apple/CarPlay™/Android Auto™ requires phone with compatible version of Apple iOS/ Android™ (as applicable), active data service, and connection cable (sold separately). Sync® does not control Apple CarPlay™/Android Auto™ while in use. Apple/Google and other third parties are responsible for their respective functionality. Message and data rates may apply. Apple CarPlay™, Apple Maps, Siri Eyes Free, iPod and iPhone are trademarks of Apple Inc. registered in the US and other countries. Android Auto and Google Maps are trademarks of Google Inc. Ford AppLink® is available on selected Sync® models and is compatible with select smartphone platforms. Warning: Local laws prohibit some phone functions while driving. Check your local road rules before using these functions. 6. Use of FordPass is subject to the FordPass Terms and Privacy Policy and the Connected Vehicle Terms and Privacy Policy available on ford.com.au/fordpass and requires a compatible mobile device, internet access and software (including software updates from time to time). You are responsible for internet access, mobile network data and voice call services required for your use of the FordPass App on your mobile device, including associated fees. The FordPass Connect Modem and FordPass App can only work when connected to the telecommunications network. Ford cannot guarantee that FordPass will be in fully operating condition at all times and the FordPass App may be unavailable or particular FordPass services interrupted. Ford is not responsible for any limitations or restrictions of the telecommunications network or of your mobile device. 7. Not all SYNC® features are compatible with all phones. For compatibility, see www.ford.com.au/sync. 8. Regular Production Options are optional and available at additional cost.

# TRANSIT VAN

2022MY Transit Van

Van Long Wheelbase  
Medium Roof  
**11.0**  
cu.m



Transit 350L  
LWB RWD Van shown.

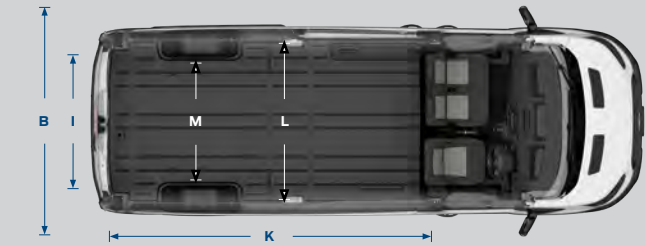
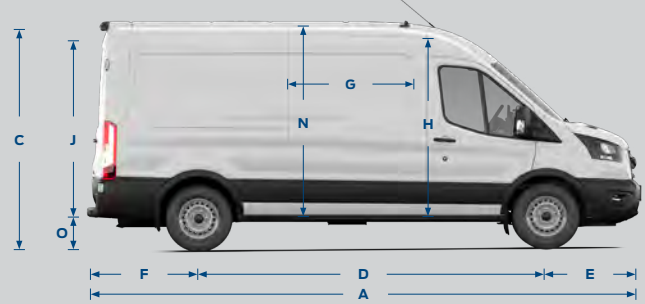

Van Extra Long  
Wheelbase  
High Roof  
**15.1**  
cu.m

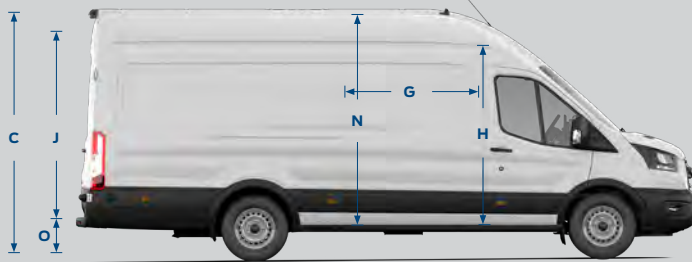

Transit 350E  
LWB RWD Van shown.

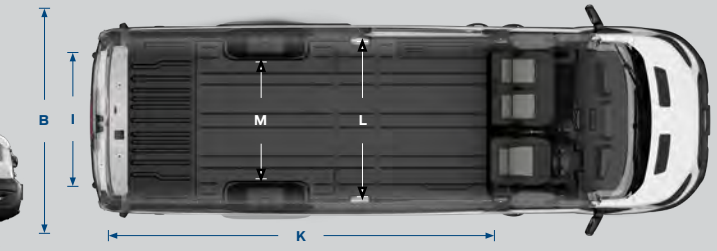

## Transit Van Dimensions & Weights

Measurements Dimensions (mm)	Transit 350L LWB RWD Van	Transit 350L LWB FWD Van	Transit 350E RWD Jumbo Van	Transit 430E RWD Jumbo Van	Transit 470E RWD Jumbo Van
A. Overall Length	5,981	5,981	6,704	6,704	6,704
B. Overall Width with Mirrors	2,474	2,474	2,474	2,474	2,474
C. Overall Height (Mid Roof / High Roof)*	2,443 - 2,533 / 2,682 - 2,769	2,411 - 2,530 / 2,650 - 2,767	- / 2,680 - 2,778	- / 2,680 - 2,778	- / 2,680 - 2,778
D. Wheelbase	3,750	3,750	3,750	3,750	3,750
E. Front of Vehicle to Front Wheel Centre	1,023	1,023	1,023	1,023	1,023
F. Rear of Vehicle to Rear Wheel Centre	1,208	1,208	1,931	1,931	1,931
G. Side Door Entry Width	1,300	1,300	1,300	1,300	1,300
H. Side Load Door Entry Height	1,600	1,700	1,600	1,600	1,600
I. Rear Door/Tailgate Entry Width	1,565	1,565	1,565	1,565	1,565
J. Rear Door/Tailgate Entry Height (Mid Roof / High Roof)	1,648 / 1,887	1,748 / 1,987	- / 1,887	- / 1,887	- / 1,887
K. Maximum Load Space Length (At Floor with Bulkhead)	3,533	3,533	4,256	4,256	4,256
L. Maximum Load Space Width	1,784	1,784	1,784	1,784	1,784
M. Load Space Between Wheel Arches (SRW / DRW)	1,392 / -	1,392 / -	1,392 / -	- / 1,154	- / 1,154
N. Load Floor To Roof (Mid Roof / High Roof)	1,786 / 2,025	1,886 / 2,125	- / 2,025	- / 2,025	- / 2,025
O. Rear Load Floor Height (Mid Roof / High Roof)	608 - 695 / 608 - 692	478 - 592 / 478 - 590	608 - 677	608 - 677	608 - 677
Maximum Load Volume (with Bulkhead) (cu.m) (Mid Roof / High Roof)	11.0 / 12.4	11.5 / 13.0	- / 15.1	- / 15.1	- / 15.1
Euro Pallet Capacity (1,200mm x 800mm)	4	4	5	5	5

\* Height dimensions show a range from min. to max. of a fully laden, lowest payload vehicle to unladen highest payload vehicle. These illustrations are for guidance only. All dimensions (shown in mm) are subject to manufacturing tolerances and do not include additional equipment. **SRW** - Single Rear Wheel. **DRW** - Dual Rear Wheel. **VDA** - This is the method used by the Verband der Automobilindustrie (VDA) in Germany. A VAD figure is determined by filling the load space with 'litre' blocks, each measuring 200x100x50mm. The blocks are then counted, and the numerical result is converted into cubic meters. The actual weight will always be subject to manufacturing tolerances which may result in payload variations between this guide and actual weight. If intending to load the vehicle close to the maximum payload, we suggest a margin of 5% to Kerb Mass figure to reduce risk of overloading.

# TRANSIT VAN

2022MY Transit Van

## Transit Van Dimensions & Weights

Measurements Weights & Loads (kg) (3 seats)	Transit 350L LWB RWD Van	Transit 350L LWB FWD Van	Transit 350E RWD Jumbo Van	Transit 430E RWD Jumbo Van	Transit 470E RWD Jumbo Van
Payload (Manual: Mid Roof / High Roof Auto: Mid Roof / High Roof)	1,171 / 1,127 1,099 / 1,055	- / - 1,213 / 1,168	- / 983 - / 911	- / - - / 1,510	- / 1,755 - / -
Gross Vehicle Mass	3,550	3,550	3,550	4,300	4,490
Maximum Kerb Weight (Manual: Mid Roof / High Roof Auto: Mid Roof / High Roof)	2,376 / 2,420 2,448 / 2,492	- / - 2,313 / 2,358	- / 2,564 - / 2,636	- / - - / 2,787	- / 2,732 - / -
Gross Combined Mass (Manual: Mid Roof / High Roof Auto: Mid Roof / High Roof)	5,650 / 5,650 6,100 / 6,100	- / - 4,250 / 4,250	- / 5,650 - / 6,100	- / - - / 6,100	- / 7,000 - / -
Axle Plated Mass (Front / Rear)	1,750 / 2,250	1,850 / 2,250	1,750 / 2,250	1,850 / 3,300	1,850 / 3,100
Maximum Braked Towing Capacity**	2,750	1,700	2,750	2,400	3,500

\*\* When fitted with appropriate after-market tow bar and trailer brake controller. Towing capacity subject to regulatory requirements, towbar and vehicle design and towing equipment limitations. Further weight restrictions apply, please consult your authorised Ford Dealer and/or refer to the Owners Manual for guidance.

## Specifications 2022MY Transit Van

	Transit 350L LWB RWD Van	Transit 350L LWB FWD Van	Transit 350E RWD Jumbo Van	Transit 430E RWD Jumbo Van	Transit 470E RWD Jumbo Van
<b>Engine</b>					
2.0L EcoBlue Engine	S	S	S	S	S
Power – Maximum (DIN)	125kW @ 3,500rpm	125kW @ 3,500rpm	125kW @ 3,500rpm	125kW @ 3,500rpm	125kW @ 3,500rpm
Torque – Maximum (DIN), Valves	390Nm @ 1,600 - 2,300rpm, 16	390Nm @ 1,600 - 2,300rpm, 16	390Nm @ 1,600 - 2,300rpm, 16	390Nm @ 1,600 - 2,300rpm, 16	390Nm @ 1,600 - 2,300rpm, 16
Drive Configuration	RWD	FWD	RWD	RWD	RWD
Auto Stop/Start <sup>1</sup>	S	S	S	S	S
<b>Transmission</b>					
6-speed Manual	S	-	S	-	S
6-speed Automatic	-	S	-	-	-
10-speed Automatic	O	-	O	S	-
<b>Fuel</b>					
Fuel	Diesel	Diesel	Diesel	Diesel	Diesel
Fuel Tank Capacity (Litres)	95	70	95	95	95
AdBlue <sup>®</sup> Tank Capacity (Litres)	21	21	21	21	21
<b>Brakes</b>					
Front and Rear Disc Brakes	S	S	S	S	S
<b>Suspension</b>					
Front - Independent MacPherson Struts	S	S	S	S	S
Rear - Single Leaf Springs	S	S	S	S	S
<b>Steering</b>					
Power Assisted Steering	S	S	S	S	S
Tilt/Telescopic Steering	S	S	S	S	S
Turning Circle - Kerb to kerb (m)	13.3	13.3	13.3	13.3	13.3
<b>Wheels &amp; Tyres</b>					
Wheel Size	6.5 x 16"	6.5 x 16"	6.5 x 16"	6 x 16"	6 x 16"
Wheel Type	Steel	Steel	Steel	Steel	Steel
Tyre Size	235/65 R16	235/65 R16	235/65 R16	195/75 R16	195/75 R16
Rear Wheel Configuration	Single	Single	Single	Dual	Dual
Spare Wheel	Conventional Steel	Conventional Steel	Conventional Steel	Conventional Steel	Conventional Steel

S = Standard O = Factory Option that can be ordered before a vehicle is manufactured

1. Auto Stop/Start will not occur in all situations.

# TRANSIT VAN

2022MY Transit Van

## Specifications 2022MY Transit Van

	Transit 350L LWB RWD Van	Transit 350L LWB FWD Van	Transit 350E RWD Jumbo Van	Transit 430E RWD Jumbo Van	Transit 470E RWD Jumbo Van
<b>Safety</b>					
6 Airbags - Driver, Front Passenger, Front Side Curtain & Front Side Seat	S	S	S	S	S
Autonomous Emergency Braking (AEB) with Pedestrian Detection <sup>2</sup>	S	S	S	S	S
Brakes - Electronic Brakeforce Distribution (EBD) <sup>2</sup>	S	S	S	S	S
Brakes - Emergency Brake Assist (EBA) <sup>2</sup>	S	S	S	S	S
Dynamic Stability Control (DSC) incorporating Anti-Lock Brake System <sup>2</sup>	S	S	S	S	S
Emergency Brake Light	S	S	S	S	S
Load Adaptive Control <sup>2</sup>	S	S	S	S	S
MyKey™	S	S	S	S	S
Rear Window Defroster	S	S	S	S	S
Roll Over Mitigation <sup>2</sup>	S	S	S	S	S
Traction Control System <sup>2</sup>	S	S	S	S	S
Trailer Sway Control <sup>2</sup>	S	S	S	S	S
<b>Security</b>					
Bonnet Release - Key Operated	S	S	S	S	S
Remote Keyless Entry - 2 Fobs	S	S	S	S	S
Twin Stage Locking	S	S	S	S	S
<b>Driver Assistance</b>					
Adaptive Cruise Control <sup>2</sup>	S	S	S	S	S
Blind Spot Monitoring System (BLIS) <sup>2</sup>	S	S	S	S	S
Hill Launch Assist <sup>2</sup>	S	S	S	S	S
Lane Keeping Aid with Lane Departure Warning <sup>2</sup>	S	S	S	S	S
Rear Cross Traffic Alert <sup>2</sup>	S	S	S	S	S
Reverse Camera with Front & Rear Parking Sensors <sup>2</sup>	S	S	S	S	S
Side Wind Stabilisation <sup>2</sup>	S	S	S	S	S
Tool Kit	S	S	S	S	S
Vehicle Maintenance Monitor <sup>2</sup>	S	S	S	S	S
<b>Interior Features</b>					
<b>Comfort &amp; Convenience</b>					
4.2" Colour Cluster Screen	S	S	S	S	S
Air Conditioning - Manual Front Single Zone	S	S	S	S	S
Air Pollen Filter	S	S	S	S	S
Drivers Armrest	S	S	S	S	S
Glass - Tinted	S	S	S	S	S
Header Courtesy Light	S	S	S	S	S
KPH Speedometer	S	S	S	S	S
Leather Wrapped Steering Wheel with Cruise Control and SYNC® Control Buttons. Reach and Height Adjustable.	S	S	S	S	S
Power - 12V Power Socket in Rear Compartment	S	S	S	S	S
Sealed Floor - Partial Rubber, Easy Cleaning	S	S	S	S	S
Trip Computer	S	S	S	S	S

S = Standard O = Factory Option that can be ordered before a vehicle is manufactured

2. Driver-assist features are supplemental and do not replace the driver's attention, judgment and need to control the vehicle. May not operate in some driving and road conditions (including at certain speeds) or adverse weather.

# TRANSIT VAN

2022MY Transit Van

## Specifications 2022MY Transit Van

Windows - Power Front (Driver Side One Touch Up/Down)	S	S	S	S	S
	Transit 350L LWB RWD Van	Transit 350L LWB FWD Van	Transit 350E RWD Jumbo Van	Transit 430E RWD Jumbo Van	Transit 470E RWD Jumbo Van
<b>Seating</b>					
Dual Front Passenger Fixed Seats with 2-way Manual Adjustment and Under Seat Stowage Compartment	S	S	S	S	S
Heated Driver and Passenger Seats	S	S	S	S	S
Single Driver 10-way Manual Adjustment, Arm Rest and Lumbar with Cushion Tilt	S	S	S	S	S
Single Front Passenger Seat (in lieu of Dual Front)	O	O	O	O	O
Trim - Cloth	S	S	S	S	S
<b>Storage</b>					
Bottle Holders - Two 2 Litre	S	S	S	S	S
Bulkhead - Full Width with Window	S	S	S	S	S
Cup Holders - 2	S	S	S	S	S
Door - Storage Pockets (Fit A4 Clipboard and 2 Litre Bottle)	S	S	S	S	S
Glove Box with Lockable Lid	S	S	S	S	S
Load Area Protection Kit	S	S	S	S	S
Load Compartment Lamp	S	S	S	S	S
Load Area Tie Down Points (8)	S	S	S	S	S
<b>Audio, Communications &amp; Instruments</b>					
2x USB Ports	S	S	S	S	S
4 Speakers (2 Woofers, 2 Tweeters)	S	S	S	S	S
Apple CarPlay™ and Android Auto™ Integration <sup>3</sup>	S	S	S	S	S
Audio - DAB+/AM/FM Radio	S	S	S	S	S
Audio - Steering Wheel Mounted Controls	S	S	S	S	S
Floating 8.0" Capacitive Touch Screen	S	S	S	S	S
FordPass Connect - Embedded Modem <sup>4</sup>	S	S	S	S	S
Satellite Navigation with TMC & Enhanced Voice Control	O	O	O	O	O
SYNC@3 <sup>5</sup> Connectivity System with Applink™	S	S	S	S	S

S = Standard O = Factory Option that can be ordered before a vehicle is manufactured

<sup>3</sup>. Apple/CarPlay™/Android Auto™ requires phone with compatible version of Apple ios/ Android™ (as applicable), active data service, and connection cable (sold separately). Sync@ does not control Apple CarPlay™/Android Auto™ while in use. Apple/Google and other third parties are responsible for their respective functionality. Message and data rates may apply. Apple CarPlay™, Apple Maps, Siri Eyes Free, iPod and iPhone are trademarks of Apple Inc. registered in the US and other countries. Android Auto and Google Maps are trademarks of Google Inc. Ford Applink@ is available on selected Sync@ models and is compatible with select smartphone platforms. Warning: Local laws prohibit some phone functions while driving. Check your local road rules before using these functions. <sup>4</sup>. Use of FordPass is subject to the FordPass Terms and Privacy Policy and the Connected Vehicle Terms and Privacy Policy available on [ford.com.au/fordpass](http://ford.com.au/fordpass) and requires a compatible mobile device, internet access and software (including software updates from time to time). You are responsible for internet access, mobile network data and voice call services required for your use of the FordPass App on your mobile device, including associated fees. The FordPass Connect Modem and FordPass App can only work when connected to the telecommunications network. Ford cannot guarantee that FordPass will be in fully operating condition at all times and the FordPass App may be unavailable or particular FordPass services interrupted. Ford is not responsible for any limitations or restrictions of the telecommunications network or of your mobile device. <sup>5</sup>. Not all SYNC@ features are compatible with all phones. For compatibility, see [www.ford.com.au/sync](http://www.ford.com.au/sync).

# TRANSIT VAN

2022MY Transit Van

## Specifications 2022MY Transit Van

	Transit 350L LWB RWD Van	Transit 350L LWB FWD Van	Transit 350E RWD Jumbo Van	Transit 430E RWD Jumbo Van	Transit 470E RWD Jumbo Van
<b>Exterior Features</b>					
<b>Styling</b>					
Black Grille/Rear Bumper/Bodyside Moulding/ Handles/Mirror	S	S	S	S	S
Mudflaps - Front and Rear	S	S	S	S	S
Partial Body Colour Front Bumper	S	S	S	S	S
Shielded Deadlocks	S	S	S	S	S
Trapezoidal 3-Bar Black Grille	S	S	S	S	S
<b>Lights</b>					
Auto Headlamps	S	S	S	S	S
Auto High Beam	S	S	S	S	S
Front Fog Lamps	S	S	S	S	S
Headlights - Follow-Me-Home	S	S	S	S	S
Headlights - Halogen with Daytime Running Lights	S	S	S	S	S
Headlights - Levelling Manual	S	S	S	S	S
High Mounted Stop Light	S	S	S	S	S
Lights - Side Marker Lights	-	-	S	S	S
Quad beam Headlamps	S	S	S	S	S
Rear Door Edge Reflector Strip	S	S	S	S	S
Roof Marker Lamps	-	-	-	S	S
<b>Visibility</b>					
Auto Windshield Wipers	S	S	S	S	S
Heated Windshield	S	S	S	S	S
Mirrors - Power Foldable, Electrically Operated with Side Indicators	S	S	S	S	S
<b>Stowage &amp; Carrying</b>					
Doors - Rear Glazed Twin Hinged with Extra Wide Opening	S	S	S	S	S
Doors - Side Load Sliding (Kerbside - Left Hand Side)	S	S	S	S	S
<b>Regular Production Options</b>					
Single Front Passenger Seat <sup>6</sup>	O	O	O	O	O
Doors - Dual Side Load Doors (Left & Right Side) <sup>6</sup>	O	O	O	O	O
High Roof <sup>6</sup>	O	O	S	S	S
Prestige Paint <sup>6</sup>	O	O	O	O	O
Special Vehicle Options (SVO) Paint <sup>6</sup>	O	O	O	O	O
Satellite Navigation with TMC & Enhanced Voice Control <sup>6</sup>	O	O	O	O	O

S = Standard O = Factory Option that can be ordered before a vehicle is manufactured

<sup>6</sup>. Regular Production Options are optional and available at additional cost.



# TRANSIT CAB CHASSIS

2022MY Transit Cab Chassis

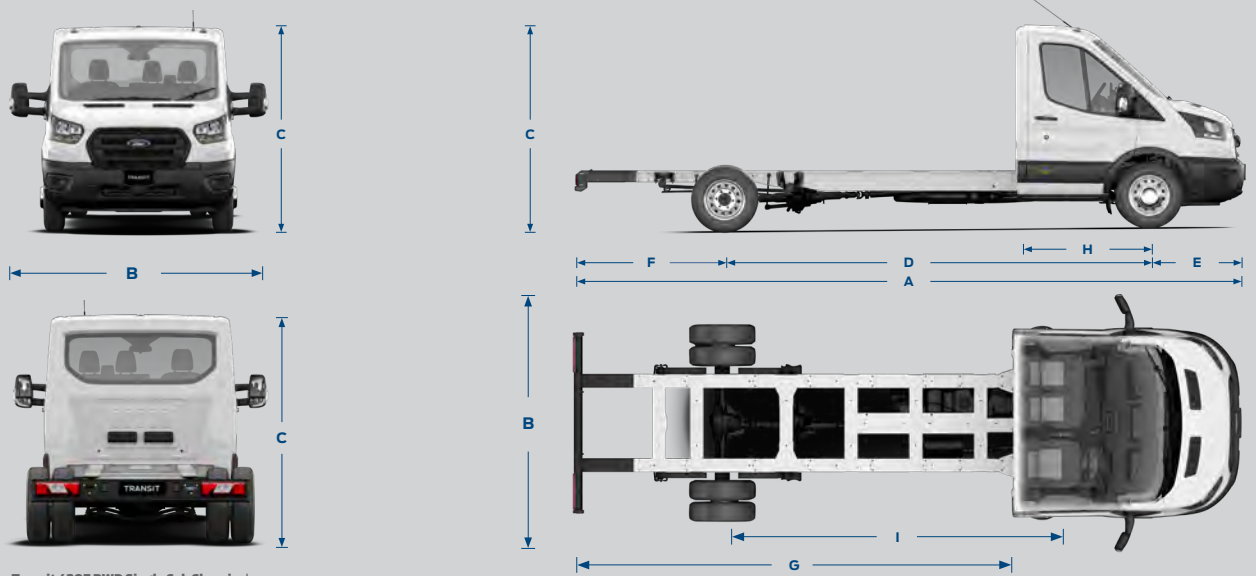

Transit 430E RWD Single Cab Chassis shown.

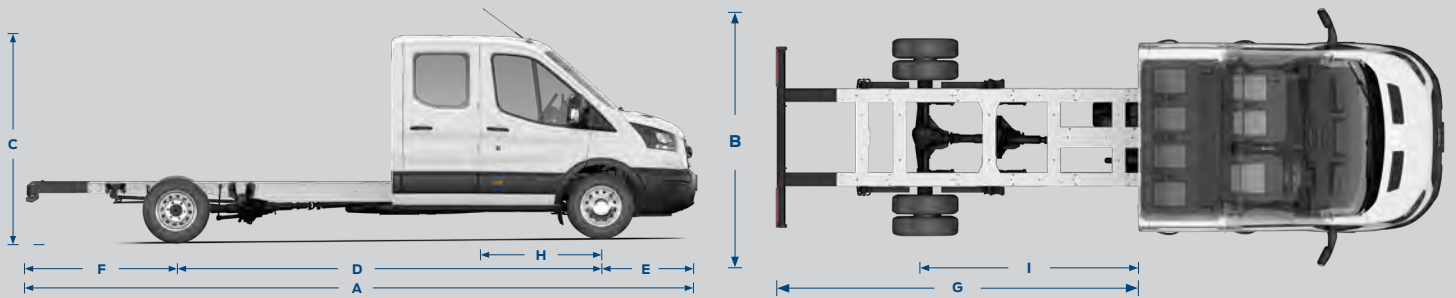

Transit 470E RWD Double Cab Chassis shown.

## Transit Cab Chassis Dimensions & Weights

Measurements Dimensions (mm)	Transit 430E RWD Single Cab Chassis	Transit 470E RWD Single Cab Chassis	Transit 470E RWD Double Cab Chassis
A. Overall Length	6,579	6,579	6,404
B. Overall Width with Mirrors	2,474	2,474	2,474
C. Overall Height *	2,167 - 2,215	2,167 - 2,215	2,157 - 2,233
D. Wheelbase	3,954	3,954	3,954
E. Front of Vehicle to Front Wheel Centre	1,023	1,023	1,023
F. Rear of Vehicle to Rear Wheel Centre	1,602	1,602	1,427
G. Chassis Frame Length	4,149	4,149	3,159
H. Rear of Cab to Front Wheel Centre	1,407	1,407	2,222
I. Rear of Cab to Rear Wheel Centre	2,547	2,547	1,732
<b>Measurements Weights &amp; Loads (kg) (3 seats)</b>			
Payload	2,186	2,431	2,269
Gross Vehicle Mass	4,300	4,490	4,490
Maximum Kerb Weight**	2,111	2,056	2,218
Gross Combined Mass	6,100	7,000	7,000
Front / Rear Axle Plated Mass	1,850 / 3,000	1,850 / 3,100	1,850 / 3,100
Maximum Braked Towing Capacity***	2,400	3,500	3,500

\* Height dimensions show a range from min. to max. of a fully laden, lowest payload vehicle to unladen highest payload vehicle. These illustrations are for guidance only. All dimensions (shown in mm) are subject to manufacturing tolerances and do not include additional equipment. The actual weight will always be subject to manufacturing tolerances which may result in payload variations between this guide and actual weight. If intending to load the vehicle close to the maximum payload, we suggest a margin of 5% to Kerb Mass figure to reduce risk of overloading. \*\* All chassis cab variants kerb mass weights are less float/tray. Addition of float/tray will affect payload. \*\*\* When fitted with appropriate after-market tow bar and trailer brake controller. Towing capacity subject to regulatory requirements, towbar and vehicle design and towing equipment limitations. Further weight restrictions apply, please consult your authorised Ford Dealer and/or refer to the Owners Manual for guidance.

# TRANSIT CAB CHASSIS

2022MY Transit Cab Chassis

## Specifications 2022MY Transit Cab Chassis

	Transit 430E RWD Single Cab Chassis	Transit 470E RWD Single Cab Chassis	Transit 470E RWD Double Cab Chassis
<b>Engine</b>			
2.0L EcoBlue Engine	S	S	S
Power – Maximum (DIN)	125kW @ 3,500rpm	125kW @ 3,500rpm	125kW @ 3,500rpm
Torque – Maximum (DIN), Valves	390Nm @ 1,600 - 2,300rpm, 16	390Nm @ 1,600 - 2,300rpm, 16	390Nm @ 1,600 - 2,300rpm, 16
Drive Configuration	RWD	RWD	RWD
Auto Stop/Start <sup>1</sup>	S	S	S
<b>Transmission</b>			
6-speed Manual	-	S	S
10-speed Automatic	S	-	-
<b>Fuel</b>			
Fuel	Diesel	Diesel	Diesel
Fuel Tank Capacity (Litres)	95	95	95
AdBlue® Tank Capacity (Litres)	21	21	21
<b>Brakes</b>			
Front and Rear Disc Brakes	S	S	S
<b>Suspension</b>			
Front - Independent MacPherson Struts	S	S	S
Rear - Single Leaf Springs	S	S	S
<b>Steering</b>			
Power Assisted Steering	S	S	S
Tilt/Telescopic Steering	S	S	S
Turning Circle - Kerb to kerb (m)	14	14	14
<b>Wheels &amp; Tyres</b>			
Wheel Size	6 x 16"	6 x 16"	6 x 16"
Wheel Type	Steel	Steel	Steel
Tyre Size	195/75 R16	195/75 R16	195/75 R16
Rear Wheel Configuration	Dual	Dual	Dual
Spare Wheel	Conventional Steel	Conventional Steel	Conventional Steel
<b>Brakes</b>			
Front and Rear Disc Brakes	S	S	S
<b>Suspension</b>			
Front - Independent MacPherson Struts	S	S	S
Rear - Single Leaf Springs	S	S	S
<b>Steering</b>			
Power Assisted Steering	S	S	S
Tilt/Telescopic Steering	S	S	S
Turning Circle - Kerb to kerb (m)	14	14	14
<b>Wheels &amp; Tyres</b>			
Wheel Size	6 x 16"	6 x 16"	6 x 16"
Wheel Type	Steel	Steel	Steel
Tyre Size	195/75 R16	195/75 R16	195/75 R16
Rear Wheel Configuration	Dual	Dual	Dual
Spare Wheel	Conventional Steel	Conventional Steel	Conventional Steel

S = Standard O = Factory Option that can be ordered before a vehicle is manufactured

1. Auto Stop/Start will not occur in all situations.

# TRANSIT CAB CHASSIS

2022MY Transit Cab Chassis

## Specifications 2022MY Transit Cab Chassis

	Transit 430E RWD Single Cab Chassis	Transit 470E RWD Single Cab Chassis	Transit 470E RWD Double Cab Chassis
<b>Safety</b>			
6 Airbags - Driver, Front Passenger, Front Side Curtain & Front Side Seat	S	S	S
Autonomous Emergency Braking with Pedestrian Detection <sup>2</sup>	S	S	S
Brakes - Electronic Brakeforce Distribution (EBD) <sup>2</sup>	S	S	S
Brakes - Emergency Brake Assist (EBA) <sup>2</sup>	S	S	S
Dynamic Stability Control (DSC) incorporating Anti-Lock Brake System <sup>2</sup>	S	S	S
Emergency Brake Light	S	S	S
Load Adaptive Control <sup>2</sup>	S	S	S
MyKey™	S	S	S
Roll Over Mitigation <sup>2</sup>	S	S	S
Traction Control System <sup>2</sup>	S	S	S
Trailer Sway Control <sup>2</sup>	S	S	S
<b>Security</b>			
Bonnet Release - Key Operated	S	S	S
Remote Keyless Entry - 2 Fobs	S	S	S
Shielded Deadlocks	S	S	S
Twin Stage Locking	S	S	S
<b>Driver Assistance</b>			
Adaptive Cruise Control <sup>2</sup>	S	S	S
Hill Launch Assist <sup>2</sup>	S	S	S
Lane Keeping Aid with Lane Departure Warning <sup>2</sup>	S	S	S
Side Wind Stabilisation <sup>2</sup>	S	S	S
Tool Kit	S	S	S
Vehicle Maintenance Monitor <sup>2</sup>	S	S	S
<b>Interior Features</b>			
<b>Comfort &amp; Convenience</b>			
4.2" Colour Cluster Screen	S	S	S
Air Conditioning - Manual Front Single Zone	S	S	S
Air Pollen Filter	S	S	S
Drivers Armrest	S	S	S
Glass - Tinted	S	S	S
Header Courtesy Light	S	S	S
KPH Speedometer	S	S	S
Leather Wrapped Steering Wheel with Cruise Control and SYNC® Control Buttons. Reach and Height Adjustable	S	S	S
Trip Computer	S	S	S
Windows - Power Front (Driver Side One Touch Up/Down)	S	S	S
<b>Seating</b>			
Dual Front Passenger Fixed Seats with 2-way Manual Adjustment and Under Seat Stowage Compartment	S	S	S
Four Rear Seating Capacity	-	-	S
Heated Driver and Passenger Seats	S	S	S
Single Driver 10-way Manual Adjustment, Arm Rest and Lumbar with Cushion Tilt	S	S	S
Single Front Passenger Seat (in lieu of Dual Front)	O	O	O
Trim - Cloth	S	S	S

S = Standard O = Factory Option that can be ordered before a vehicle is manufactured

2. Driver-assist features are supplemental and do not replace the driver's attention, judgment and need to control the vehicle. May not operate in some driving and road conditions (including at certain speeds) or adverse weather.

# TRANSIT CAB CHASSIS

2022MY Transit Cab Chassis

## Specifications 2022MY Transit Cab Chassis

	Transit 430E RWD Single Cab Chassis	Transit 470E RWD Single Cab Chassis	Transit 470E RWD Double Cab Chassis
<b>Storage</b>			
Bottle Holders - Two 2 Litre	S	S	S
Cup Holders - 2	S	S	S
Door - Storage Pockets (Fit A4 Clipboard and 2 Litre Bottle)	S	S	S
Glove Box with Lockable Lid	S	S	S
<b>Audio, Communications &amp; Instruments</b>			
2x USB Ports	S	S	S
4 Speakers (2 Woofers, 2 Tweeters)	S	S	S
Apple CarPlay™ and Android Auto™ integration <sup>3</sup>	S	S	S
Audio - DAB+ /AM/FM Radio	S	S	S
Audio - Steering Wheel Mounted Controls	S	S	S
Floating 8.0" Capacitive Touch Screen	S	S	S
FordPass Connect - Embedded Modem <sup>4</sup>	S	S	S
Satellite Navigation with TMC & Enhanced Voice Control	O	O	O
SYNC@ <sup>3</sup> Connectivity System with Applink™	S	S	S
<b>Exterior Features</b>			
<b>Styling</b>			
Black Grille/Rear Bumper/Bodyside Moulding/Handles/Mirror	S	S	S
Mudflaps - Front	S	S	S
Partial Body Colour Front Bumper	S	S	S
Trapezoidal 3-Bar Black Grille	S	S	S
<b>Lights</b>			
Headlights - Follow-Me-Home	S	S	S
Headlights - Levelling Manual	S	S	S
Headlights - Halogen With Daytime Running Lights	S	S	S
Auto Headlamps	S	S	S
Auto Highbeam	S	S	S
Quad Beam Headlamps	S	S	S
Roof Marker Lamps	S	S	S
<b>Visibility</b>			
Mirrors - Heated, Electrically Operated with Side Indicators	S	S	S
Heated Windshield	S	S	S
Wipers - Automatic Windshield Wipers	S	S	S
<b>Regular Production Options</b>			
Single Front Passenger Seat <sup>6</sup>	O	O	O
Prestige Paint <sup>6</sup>	O	O	O
Special Vehicle Options (SVO) Paint <sup>6</sup>	O	O	O
Satellite Navigation with TMC & Enhanced Voice Control <sup>6</sup>	O	O	O

S = Standard O = Factory Option that can be ordered before a vehicle is manufactured

3. Apple/CarPlay™/Android Auto™ requires phone with compatible version of Apple ios/ Android™ (as applicable), active data service, and connection cable (sold separately). Sync® does not control Apple CarPlay™/Android Auto™ while in use. Apple/Google and other third parties are responsible for their respective functionality. Message and data rates may apply. Apple CarPlay™, Apple Maps, Siri Eyes Free, iPod and iPhone are trademarks of Apple Inc. registered in the US and other countries. Android Auto and Google Maps are trademarks of Google Inc. Ford Applink® is available on selected Sync® models and is compatible with select smartphone platforms. Warning: Local laws prohibit some phone functions while driving. Check your local road rules before using these functions. 4. Use of FordPass is subject to the FordPass Terms and Privacy Policy and the Connected Vehicle Terms and Privacy Policy available on ford.com.au/fordpass and requires a compatible mobile device, internet access and software (including software updates from time to time). You are responsible for internet access, mobile network data and voice call services required for your use of the FordPass App on your mobile device, including associated fees. The FordPass Connect Modem and FordPass App can only work when connected to the telecommunications network. Ford cannot guarantee that FordPass will be in fully operating condition at all times and the FordPass App may be unavailable or particular FordPass services interrupted. Ford is not responsible for any limitations or restrictions of the telecommunications network or of your mobile device. 5. Not all SYNC® features are compatible with all phones. For compatibility, see www.ford.com.au/sync. 6. Regular Production Options are optional and available at additional cost.

# TRANSIT BUS

2022MY Transit Bus



## Transit Bus Dimensions & Weights

Measurements Dimensions (mm)	Transit Bus 410L RWD 12-SEAT
A. Overall Length	5,981
B. Overall Width With Mirrors	2,474
C. Overall Height (Mid Roof / High Roof)*	2,438 - 2,528 / 2,677 - 2,764
D. Wheelbase	3,750
E. Front Of Vehicle To Front Wheel Centre	1,023
F. Rear Of Vehicle To Rear Wheel Centre	1,208
G. Side Door Entry Width	1,200
H. Side Load Door Entry Height	1,564
I. Rear Door Entry Width	1,520
J. Rear Door Entry Height (Mid Roof / High Roof)	1,597 / 1,836
K. Space between wheel arches	1364
Measurements Weights & Loads (kg) (3 seats)	
Payload (Mid Roof / High Roof)	1,253 / 1,208
Gross Vehicle Mass	4,100
Maximum Kerb Weight (Mid Roof / High Roof)	2,844 / 2,889
Gross Combined Mass	6,100
Front / Rear Axle Plated Mass	1,850 / 2,500
Maximum Braked Towing Capacity**	2,500

SRW - Single Rear Wheel. DRW - Dual Rear Wheel.

\* Height dimensions show a range from min. to max. of a fully laden, lowest payload vehicle to unladen highest payload vehicle. These illustrations are for guidance only. All dimensions (shown in mm) are subject to manufacturing tolerances and do not include additional equipment. The actual weight will always be subject to manufacturing tolerances which may result in payload variations between this guide and actual weight. If intending to load the vehicle close to the maximum payload, we suggest a margin of 5% to Kerb Mass figure to reduce risk of overloading. \*\* When fitted with appropriate after-market tow bar and trailer brake controller. Towing capacity subject to regulatory requirements, towbar and vehicle design and towing equipment limitations. Further weight restrictions apply, please consult your authorised Ford Dealer and/or refer to the Owners Manual for guidance.

# TRANSIT BUS

## 2022MY Transit Bus

	Transit Bus 410L RWD 12-SEAT
<b>Engine</b>	
2.0L EcoBlue Engine	S
Power - Maximum (DIN)	125kW @ 3,500rpm
Torque - Maximum (DIN), Valves	390Nm @ 1,600 - 2,300rpm, 16
Drive Configuration	RWD
Auto Stop/Start <sup>1</sup>	S
<b>Transmission</b>	
10-Speed Automatic	S
<b>Fuel</b>	
Fuel	Diesel
Fuel Tank Capacity (Litres)	95
AdBlue Tank (Litres)	21
<b>Brakes</b>	
Front and Rear Disc Brakes	S
<b>Suspension</b>	
Front - Independent MacPherson Struts	S
<b>Steering</b>	
Power Assisted Steering	S
Tilt/Telescopic Steering	S
Turning Circle - Kerb to kerb (m)	13.3
<b>Wheels and Tyres</b>	
Wheel Size	6.5 x 16"
Wheel Type	Steel
Tyre Size	235/65 R16
Rear Wheel Configuration	Single
Spare Wheel	Conventional Steel
<b>Safety</b>	
6 Airbags - Driver, Front Passenger, Front Side Curtain & Front Side Seat	S
Autonomous Emergency Braking with Pedestrian Detection <sup>2</sup>	S
Brakes - Electronic Brakeforce Distribution (EBD) <sup>2</sup>	S
Brakes - Emergency Brake Assist (EBA) <sup>2</sup>	S
Dynamic Stability Control (DSC) incorporating ABS <sup>2</sup>	S
Emergency Brake Light	S
Load Adaptive Control <sup>2</sup>	S
MyKey™	S
Rear Window Defroster	S
Roll Over Mitigation <sup>2</sup>	S
Traction Control System <sup>2</sup>	S
Trailer Sway Control <sup>2</sup>	S

	Transit Bus 410L RWD 12-SEAT
<b>Security</b>	
Bonnet Release - Key Operated	S
Remote Keyless Entry - 2 Fobs	S
Perimeter Anti-Theft Alarm	S
Twin Stage Locking	S
<b>Driver Assistance</b>	
Tool Kit	S
Vehicle Maintenance Monitor <sup>2</sup>	S
Reverse Camera with Front & Rear Parking Sensors <sup>2</sup>	S
Adaptive Cruise Control <sup>2</sup>	S
Hill Launch Assist <sup>2</sup>	S
Blind Spot Monitoring System (BLIS) <sup>2</sup>	S
Side Wind Stabilisation <sup>2</sup>	S
Rear Cross Traffic Alert <sup>2</sup>	S
Lane Keeping Aid with Lane Departure Warning and Driver Alert <sup>2</sup>	S
<b>Interior Features</b>	
<b>Comfort and Convenience</b>	
Air Conditioning - Manual Front Single Zone	S
Air Pollen Filter	S
Leather Wrapped Steering Wheel with Cruise Control and SYNC® Control Buttons. Reach and Height Adjustable.	S
Drivers Armrest	S
First Aid Kit	S
Header Courtesy Light	S
Power - 12V Power Socket in Rear Compartment	S
Sealed Floor - Partial Rubber, Easy Cleaning	S
4.2" Colour Cluster Screen	S
KPH Speedometer	S
Trip Computer	S
Windows - Power Front (Driver Side One Touch Up/Down)	S
Glass - Tinted	S
<b>Seating</b>	
Single Driver 10-way Manual Adjustment, Arm Rest and Lumbar with Cushion Tilt	S
Dual Front Passenger Fixed Seats with 2-way Manual Adjustment and Under Seat Stowage Compartment	S
Single Front Passenger Seat (in lieu of Dual Front) <sup>3</sup>	O
Heated Driver and Front Passenger Seats	S
Trim - Cloth	S
<b>Storage</b>	
Bottle Holders - Two 2 Litre	S
Cup Holders - 2	S
Door - Storage Pockets (Fit A4 Clipboard and 2 Litre Bottle)	S
Glove Box with Lockable Lid	S
Load - Compartment Lamp	S

S = Standard O = Factory Option that can be ordered before a vehicle is manufactured

1. Auto Stop/Start will not occur in all situations. 2. Driver-assist features are supplemental and do not replace the driver's attention, judgment and need to control the vehicle. May not operate in some driving and road conditions (including at certain speeds) or adverse weather. 3. Changes total Transit Bus seating capacity to 11.

# TRANSIT BUS

2022MY Transit Bus

	Transit Bus 410L RWD 12-SEAT
<b>Audio, Communications &amp; Instruments</b>	
2x USB Ports	S
4 Speakers (2 Woofers, 2 Tweeters)	S
Apple CarPlay™ and Android Auto™ integration <sup>4</sup>	S
Audio - Steering Wheel Mounted Controls	S
Audio - DAB+/AM/FM Radio	S
Floating 8.0" Capacitive Touch Screen	S
FordPass Connect - Embedded Modem <sup>5</sup>	S
SYNC@3 <sup>6</sup> Connectivity System with Applink™	S
<b>Exterior Features</b>	
<b>Roof height</b>	
Medium Roof	S
<b>Styling</b>	
Mudflaps - Front and Rear	S
Partial Body Colour Front Bumper	S
Black Grille/Rear Bumper/Bodyside Moulding/Handles/Mirror	S
Trapezoidal 3-Bar Black Grille	S
<b>Lights</b>	
Front Fog Lamps	S
Headlights - Follow-Me-Home	S
Headlights - Levelling Manual	S
Headlights - Halogen with Daytime Running Lights	S
Auto Headlamps	S

	Transit Bus 410L RWD 12-SEAT
<b>Lights continued.</b>	
Auto High Beam	S
Quad beam Headlamps	S
High Mounted Stop Light	S
Lights - Side Marker Lights	S
Rear Door Edge Reflector Strip	S
<b>Visibility</b>	
Mirrors - Power Foldable, Electrically Operated with Side Indicators	S
Heated Windshield	S
Wipers - Auto Windshield Wipers	S
Fixed 2nd, 3rd & 4th Row Right & Left Hand Side Window	S
Privacy Glass	S
<b>Stowage &amp; Carrying</b>	
Doors - Side Load Power Operating (Kerbside - Left Hand Side)	S
Power Side Step	S
<b>Regular Production Options</b>	
Single Front Passenger Seat <sup>3,7</sup>	O
High Roof with Overhead Stowage Shelves and LED Reading Lights <sup>7</sup>	O
Prestige Paint <sup>7</sup>	O
Special Vehicle Options (SVO) Paint <sup>7</sup>	O
Satellite Navigation with TMC & Enhanced Voice Control <sup>7</sup>	O

S = Standard O = Factory Option that can be ordered before a vehicle is manufactured

<sup>3.</sup> Changes total Transit Bus seating capacity to 11. <sup>4.</sup> Apple/CarPlay™/Android Auto™ requires phone with compatible version of Apple ios/ Android™ (as applicable), active data service, and connection cable (sold separately). Sync® does not control Apple CarPlay™/Android Auto™ while in use. Apple/Google and other third parties are responsible for their respective functionality. Message and data rates may apply. Apple CarPlay™, Apple Maps, Siri Eyes Free, iPod and iPhone are trademarks of Apple Inc. registered in the US and other countries. Android Auto and Google Maps are trademarks of Google Inc. Ford Applink® is available on selected Sync® models and is compatible with select smartphone platforms. Warning: Local laws prohibit some phone functions while driving. Check your local road rules before using these functions. <sup>5.</sup> Use of FordPass is subject to the FordPass Terms and Privacy Policy and the Connected Vehicle Terms and Privacy Policy available on [ford.com.au/fordpass](http://ford.com.au/fordpass) and requires a compatible mobile device, internet access and software (including software updates from time to time). You are responsible for internet access, mobile network data and voice call services required for your use of the FordPass App on your mobile device, including associated fees. The FordPass Connect Modem and FordPass App can only work when connected to the telecommunications network. Ford cannot guarantee that FordPass will be in fully operating condition at all times and the FordPass App may be unavailable or particular FordPass services interrupted. Ford is not responsible for any limitations or restrictions of the telecommunications network or of your mobile device. <sup>6.</sup> Not all SYNC@ features are compatible with all phones. For compatibility, see [www.ford.com.au/sync](http://www.ford.com.au/sync). <sup>7.</sup> Regular Production Options are optional and available at additional cost.