

CHALLENGER



love that car



LOVE THAT CAR

HERE AT MITSUBISHI, WE LOVE OUR VEHICLES. WE LOVE THEIR SUPERIOR QUALITY,

*WHAT THEY STAND FOR,
AND WHAT THEY'RE CAPABLE OF.*

AND WE WANT YOU TO FEEL THE SAME WAY.

IT'S WHY WE STRIVE FOR THE HIGHEST STANDARDS IN EVERYTHING WE DO,

AND IT'S WHY WE BACK ALL OUR VEHICLES WITH OUR MITSUBISHI DIAMOND ADVANTAGE,

NEW CAR WARRANTY, CAPPED PRICE SERVICING AND CUSTOMER CARE.





STREET PRESENCE

We design attention grabbing vehicles with real street presence. We're focussed on delivering vehicle design that not only defines the best in innovation but embodies the essence of genuine performance, handling dynamics and absolute driving pleasure.



ADVANCED TECHNOLOGY

We'll continue to develop ground-breaking technology that focuses on better control, performance and lifestyle. This includes innovations such as our Mitsubishi All Terrain Technology (MATT™) and our variable geometry turbo diesel engine.



DRIVER CONFIDENCE

Enjoy the peace of mind that comes with every Mitsubishi as we continue to develop new safety technologies. The Mitsubishi Reinforced Impact Safety Evolution (RISE) body design is just part of our commitment to building world class cars in terms of safety. Other features like Active Stability Control, Active Traction Control and Hill Start Control put Challenger at the forefront of safety technology.



SUPERIOR VALUE

We are constantly striving to deliver the ultimate customer experience. That's why we developed the Mitsubishi Diamond Advantage - our commitment to ensuring you enjoy complete driving pleasure whenever you get behind the wheel of your Mitsubishi. Challenger is packed with features - reflecting our commitment to make all our vehicles more cost effective and fuel-efficient.



OUR PROMISE

When you buy a Mitsubishi Challenger, or any vehicle from our range, you're buying a vehicle that's backed by world-class research, technical innovation, and leading performance. In every area of our business, we're continually focussed on four key values. By following these values, we never fail to create superior vehicles that people love.

When you're a busy family your day can be hectic. You're always in and out of the car, running multiple errands and transporting anything from school bags to surfboards. We know that when it comes to doing all this, you want to be comfortable. You want a car you can rely on, feel confident and relaxed in, and be proud of when you sit behind the wheel. It's for these reasons that we designed the versatile Mitsubishi Challenger.

Challenger looks comfortable where ever you are – whether it's an inner city street, an open free way or rugged coastline. The 4WD models fuse Mitsubishi's proven 4WD capability with the sleek and refined lines of a sporty SUV. If you don't need 4WD capability, but still want the space, comfort and flexibility of a robust SUV, Challenger is now available with the efficiency of 2WD as well.

All models have a spacious versatile interior that makes driving a pleasure. Under the bonnet, you'll find a fuel efficient, 2.5L inter cooled turbocharged Diesel Engine with the very latest in Mitsubishi's Common Rail Direct Fuel injection system. And thanks to Mitsubishi's Super Select 4WD system, you can cross from city streets to the great outdoors with the flick of a lever.

MITSUBISHI CHALLENGER
HAS EVERYTHING YOU WOULD EXPECT
FROM A **STYLISH** *FAMILY*
SUV
PLUS THE ABILITY TO TRULY ESCAPE
TO THOSE FAVOURITE GETAWAYS
OFF THE BEATEN TRACK.





The Challenger features refined and luxurious styling and incredible seating versatility – so you can fit up to a family of seven with ease. Mitsubishi Challenger's ready for anything your family can throw at it. You can choose between two row (five-passenger) or three row (seven-passenger) seating options. The third row has a 50/50 split fold providing a variety of seating configurations.

Challenger's high driving position provides a confident view of the traffic around you. The stylish interior is durable to withstand all the family activities such as swimming lessons, trips to the beach or even weekend adventures. The interior is distinguished by clean, sleek, unbroken surfaces. The soft-touch upholstery, chrome interior handles and elegant wood-print inlays add an extra element of style. As well as leather seat trim, a leather bound steering wheel, gear shift and transfer lever, power windows, plus driver and front passenger power seats with slide, dual height and reclining functions.

Challenger puts control at your fingertips. Hands free Bluetooth mobile phone operation means you can talk without pulling over. USB and iPod connectivity means you can listen to all your favourite music tracks. And the multi-function centre display gives you an enormous amount of information about your Challenger and driving environment.



*ENJOY A
COMFORTABLE
DRIVE NO MATTER
WHERE YOU'RE HEADING.*



XLS model shown

WHETHER YOU'RE CRUISING ALONG
CITY STREETS OR EXPLORING
RUGGED TERRAIN, THE MITSUBISHI CHALLENGER IS READY
 FOR ANYTHING YOUR FAMILY CAN THROW AT IT.
 POWERED BY A 131KW, 2.5L INTERCOOLED
TURBOCHARGED
 COMMON RAIL DIRECT INJECTION DIESEL ENGINE,
THE CHALLENGER DELIVERS
 FLAWLESS PERFORMANCE AND OUTSTANDING FUEL ECONOMY



3 TONNE TOWING CAPABILITY

Challenger is equipped with a powerful 3,000kg towing capacity. The turbo diesel engine and full-time 4WD capability will make towing the boat, caravan or trailer on your next family adventure a breeze.

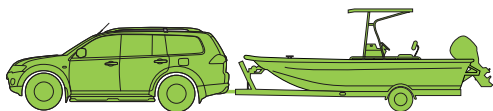

2.5L COMMON RAIL HI POWER TURBO DIESEL WITH VGT

Challenger offers the latest in Common Rail turbo diesel technology. An enhanced variable geometry turbocharger (VGT) works to optimize the turbine flow rate in order to achieve high torque at low speeds and maximised power at high speeds. The result is excellent emission control, fuel efficiency and high engine power for superior performance. The 2.5 litre turbocharged diesel engine yields next generation quietness, smoothness and fuel efficiency, taking you further for less without compromise, with an impressive 131kW of power and 400Nm of torque for the manual and 350Nm for the automatic.

5 SPEED SPORTS MODE AUTOMATIC

Sports Mode allows you to enjoy the ease and comfort of an automatic, with the option of then switching to the versatility and control of a 5 speed manual without the use of a clutch pedal.

The clutch free operation reduces the rev and torque loss usually associated with engaging gears, meaning you can maintain momentum in off-road situations.

PADDLE SHIFTS

When the gear shift is in Sports Mode position, paddles on the Challenger steering wheel allow you to make lightning quick gear changes without your hands leaving the wheel.

COMPARISON OF SHIFT RESPONSE

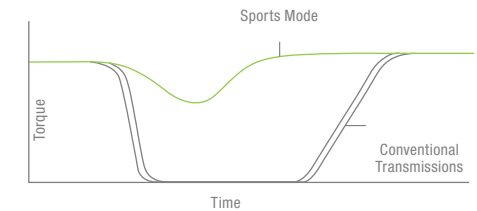

INVECS II SMART LOGIC

The Smart Logic transmission system learns and adapts to each driver's preferences by monitoring acceleration and foot brake data. The control logic then adapts the gearshift timing to suit your driving style.

ADAPTIVE SHIFT CONTROL DURING ACCELERATION



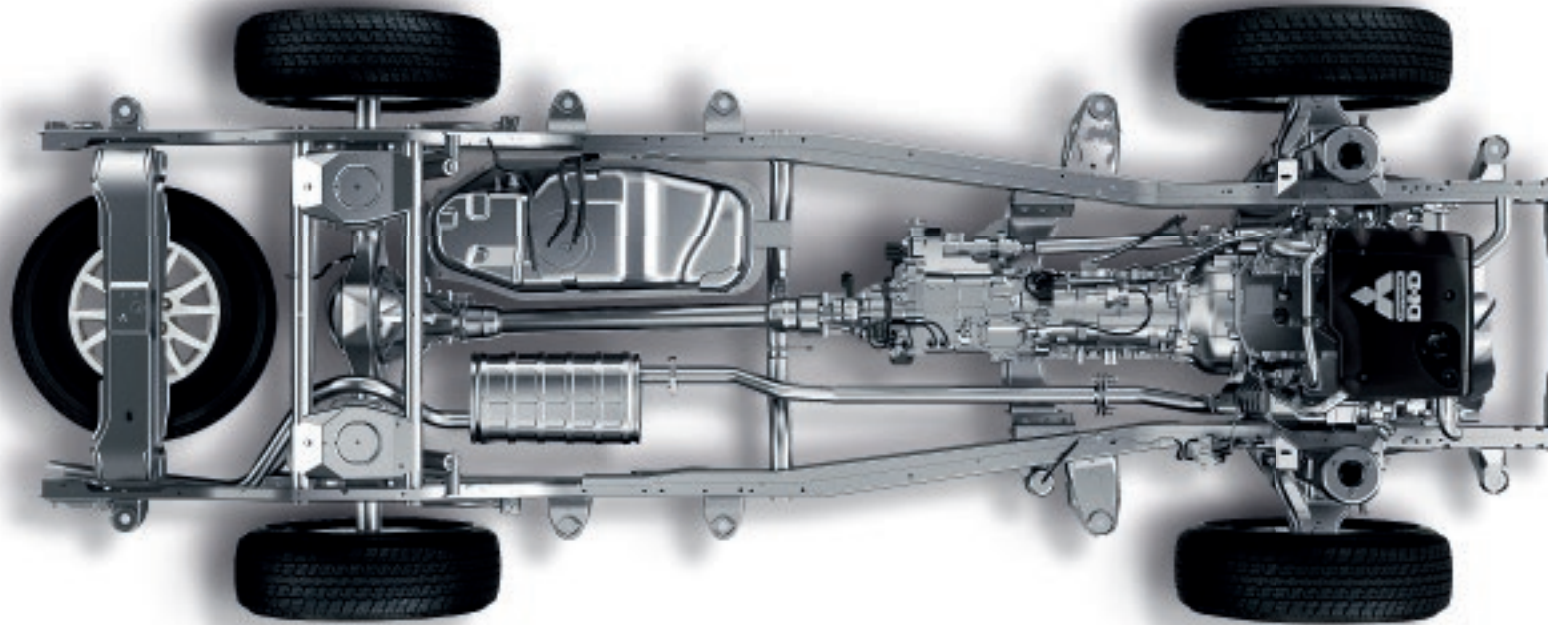

MATT
MITSUBISHI ALL TERRAIN TECHNOLOGY

Mitsubishi brings you the latest safety systems and superior 4WD technology. The 4WD Challenger boasts rally proven MATT™ (Mitsubishi All Terrain Technology) for the ultimate in on and off road driver confidence. When it comes to giving you superior control we've left no stone unturned. So Challenger can take you places other conventional SUVs would struggle with.

Challenger is seriously 4WD capable thanks to its advanced 4WD system. Enjoy the confidence of knowing that whatever the destination you want to escape to with your family, Challenger will be up for the challenge.

SUPER SELECT 4WD

The versatile Challenger inherits the 4WD-handling heritage from a long line of Mitsubishi rally champions. Superior to conventional SUVs, Challenger's Super Select 4WD offers full-time 4WD with the option of four driving modes as seen below. The Super Select 4WD system also offers the benefit of on-the-fly shifts from 2WD to 4WD high range at speeds of up to 100km/h.



2H (2WD High Range)

Whether you're cruising down the highway or just going across town, 2H mode shifts you into rear-wheel drive for smooth, quiet, fuel-efficient performance.



4H (Full-Time 4WD)

When the weather turns bad and the road gets rough, get added traction in 4H mode. Challenger's Super Select 4WD system offers the flexibility of a centre-differential with viscous coupling unit, providing excellent traction in unpredictable road conditions or on volatile surfaces.

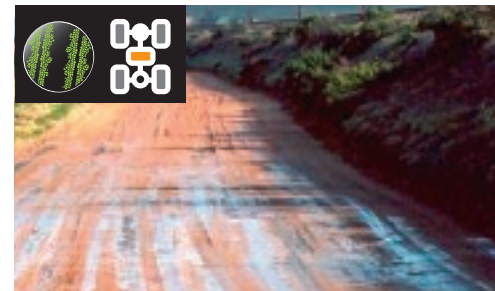

4HLC (4WD High Range w/Locked Centre Differential)

Keeping you on track in rugged or slippery conditions, 4HLC distributes power equally to all four wheels to meet off-road challenges with a steady sense of control.

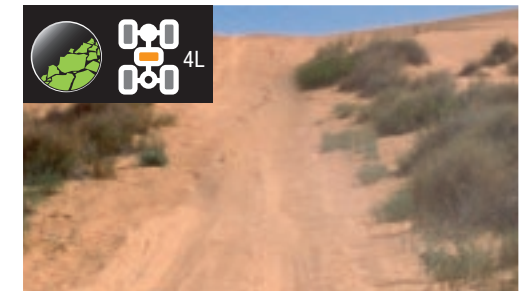

4LLC (4WD Low Range w/ Locked Centre Differential)

Switch to 4LLC when you need all the tractor-like crawling power your Mitsubishi 4WD is capable of. Maximised low-end torque pulls you through even the roughest terrain, sandiest dunes, or deepest snow to get to that isolated spot that only a truly capable 4WD can take you.

THE CHALLENGER

FEATURES SEVERAL IMPORTANT

SAFETY INNOVATIONS

TO PROTECT YOUR FAMILY.



SIX SRS AIRBAGS

To provide essential protection for your family in the event of a collision, Challenger is available with up to six airbags. The side airbags inflate from the side of the seat to protect the torso while curtain airbags activate from the roof to protect the head. The front seatbelt systems also include pretensioners and force limiters that combine to minimise the potential for serious injury in the event of a collision.

RISE SAFETY

At the heart of any integrated safety system is outstanding design. The Mitsubishi Reinforced Impact Safety Evolution (RISE) design combines an energy absorbing front section with a strong, rigid occupant cell to provide outstanding family protection in the event of an accident. The RISE body is coupled with a rigid ladder frame, side impact bars, and collision absorbing joints.

VISIBILITY

Challenger gives you the confidence of a high driving position that provides you a commanding view of the traffic conditions ahead. Large electric rear view mirrors and a reversing camera provide excellent visibility behind. In addition, rear parking sensors provide complete confidence and reassurance when reversing.

REVERSING CAMERA & REVERSE PARKING SENSORS

The reversing camera supplements the driver's rear field of view by automatically appearing on screen when reverse gear is engaged. The camera's view will appear in the electro chromatic rear view mirror. And, in models with reverse parking sensors that alert you when objects get a little close, parking your Challenger into tight spots is easy.



HIGH INTENSITY DISCHARGE HEADLAMPS (HID)

Clever self levelling HID headlamps offer brighter illumination for night time driving and automatically adjust the beam level when towing. The washer system ensures HID performance is always optimal.



MULTI-MODE ABS

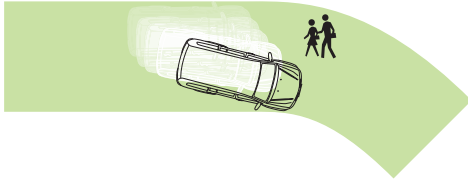

Multi-mode Anti-Lock Braking System

This allows you to manoeuvre around objects under heavy braking conditions. Challenger's intelligent 4-channel, 4-sensor braking system works in conjunction with the drive mode to monitor different wheel speeds and activate brakes to individual wheels when required to deliver superior control.

EBD

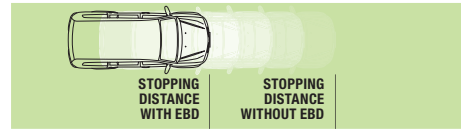

Electronic Brakeforce Distribution

This technology reduces stopping distances by detecting passengers or heavier loads and automatically increases rear-braking force.

ATC

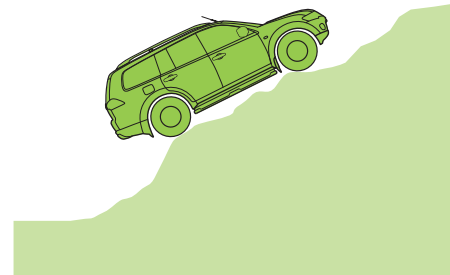

Active Traction Control

Helps you maintain traction on the most slippery or rugged of surfaces. This intelligent system automatically controls the engine output, so driving wheels are prevented from spinning. Sensing loss of traction in an independent wheel, it applies braking force to that wheel and sends extra power and torque to other wheels with traction to keep you moving.

ASC

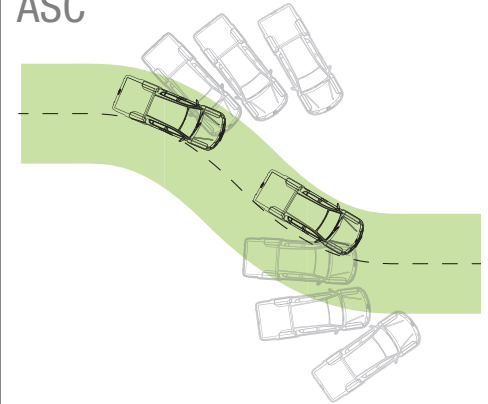

Active Stability Control

Maintains stability and prevents loss of control when cornering, automatically recognising under-steer and over-steer and applying braking force to the diagonal wheel to keep you online through corners.



SETTING THE STANDARDS IN SUSPENSION

Double-wishbone front suspension with coil springs combined with a 3-link coil spring rear suspension, both with stabiliser bars, give unmatched traction and stability with a high ground clearance for your off-road adventures.

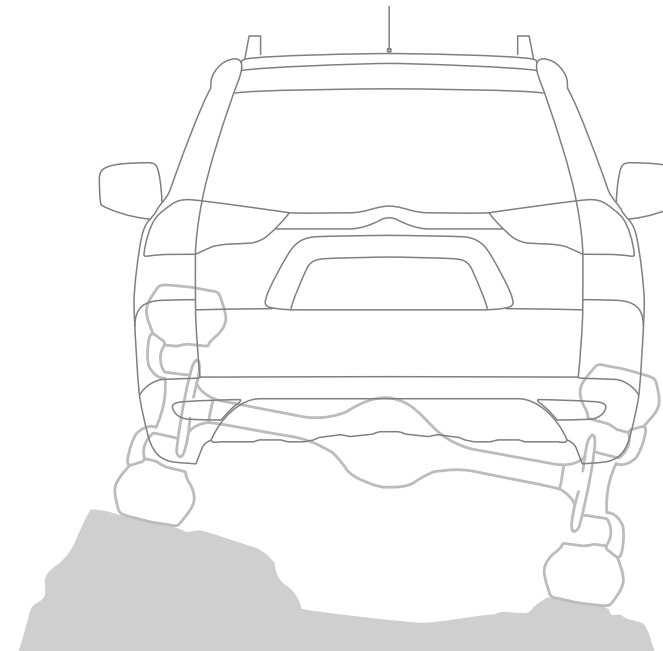

REAR DIFFERENTIAL LOCK

Challenger is available with rear diff lock to provide superior traction for heavy duty four wheel driving. When locked, both wheels receive the same amount of driving force, regardless of surface – meaning maximum possible traction in difficult situations.

WITH **VERSATILITY** THAT HAS BEEN **DESIGNED**
WITH THE **FAMILY** IN MIND, CHALLENGER BOASTS A
RANGE OF CONVENIENCE FEATURES,
CLEVER STORAGE AND SEATING CONFIGURATIONS.



Overseas model shown

SEATING COMFORT

Challenger is available with either tan or black leather facing front and second row seats, whilst both the driver and passenger seats are power adjustable.

CRUISE CONTROL

When it comes to travelling long distances for family getaways it's important to be as comfortable as possible. Thanks to Challenger's easy-to-use cruise control, you can stay relaxed on the open road, reduce fuel consumption and avoid the risk of accidental speeding. Simply set your specific speed, sit back and enjoy the drive.



STORAGE

Clever storage areas throughout the cabin ensure there's plenty of room for everything an active family could need. A handy, underfloor compartment in the seven seat option also provides extra storage when you really need it.



POWER WINDOWS

Challenger makes it easy to enjoy the scenery or to keep the weather outside at bay with the convenience of power windows.

The driver's window also has a convenient auto up and down function.





CARGO AREA

Sometimes, instead of getting away from it all you want to take it with you. Challenger's spacious cargo area can fit those large cargo items, and the folding seats give you that extra room to carry any additional suitcases, golf bags, kids toys or whatever else your family might need. And with the easy-opening tailgate, loading and unloading everything is a breeze.

SEATING CONFIGURATION

Challenger has plenty of room for the whole family with five seats and the option of a third row of two additional – seven comfortable seats.

The front seats fully recline to provide a flat surface together with the rear seats.

The second row seats have slide, recline and tumble-forward flexibility. This means you can easily create extra room when it's needed, whether it's for school bags, camping gear, sporting equipment, or even just everyday shopping.

The third row seats have a recline function and can fold away to allow for extra luggage space.



CHALLENGER BOASTS A RANGE OF
NEXT GENERATION TECHNOLOGY
 THAT MAKES ACTIVE FAMILY LIVING
**SIMPLE, STRESS FREE
 AND FUN.**

Challenger's technology makes every drive easier, more enjoyable and safer. Hands free Bluetooth mobile phone operation means you can talk without pulling over. USB and iPod connectivity means you can listen to all your favourite music tracks. And the multi-function centre display gives you an enormous amount of information about your Challenger and driving environment.



MITSUBISHI POWER SOUND SYSTEM

Mitsubishi's exclusive sound system delivers high power audio output throughout the interior via a 420W high power amp, and 8 speakers including 4 tweeters. Speakers are placed for optimal sound balance and maximum enjoyment of all occupants from front to rear.



CONNECT AND CHARGE YOUR IPOD

You can listen to all your favourite tunes when driving your Challenger, because you can connect, charge and play your iPod. It also has an audio input jack so you can connect and play MP3s whenever you like as well.



BLUETOOTH® PHONE CONNECTIVITY

Make and receive calls with Challenger's Bluetooth phone connectivity. Hands free calls means you can stay focused on the road ahead keeping you safer.

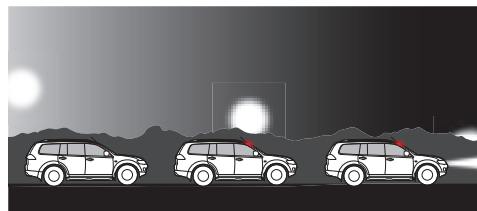

DUSK SENSING HEADLAMPS

Help you stay focused on the road at all times. A sensor on the windscreen automatically sends a signal to your lights and they will turn on when it gets dark or when you're travelling through a tunnel.



AUTO RAIN SENSING WIPERS

A sensor automatically detects moisture on the windscreen and according to the amount of rain present the system will activate the wipers at the appropriate speed.

MULTI-FUNCTION CENTRE DISPLAY

The Multi Function display provides endless information about your driving environment with clock and date, compass, barometer to track weather conditions.

Altimeter to show how high you have travelled, range to empty reading, average fuel consumption and the temperature outside the car.

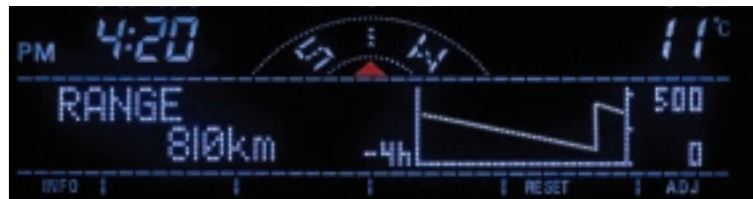

MITSUBISHI DIAMOND ADVANTAGE

NEW CAR WARRANTY AND CUSTOMER CARE PACKAGE



**MITSUBISHI
DIAMOND
ADVANTAGE**

[†]5 year or 130,000km New Vehicle Warranty (whichever comes first). Service conditions apply. ^{*}4 years or 60,000km Capped Price Servicing (whichever occurs first). Covers all items specified under the standard "Maintenance for normal operating conditions" scheduled detailed in the service and warranty booklet. Additional service/repair items (if required) are at additional cost. [†]1 year Roadside Assist (Service conditions apply). For purchases of new Mitsubishi vehicles after 1st October 2012, your initial 12 month roadside assist will be extended for a period of 12 months from the date of the most recent eligible Capped Price Service for that vehicle performed at an authorised Mitsubishi dealer. Roadside assist, if extended in accordance with these items, is available for a maximum of up to 5 years. Conditions apply. Offer subject to change without notice. Excludes Government, Rental and National Fleet customers.

5 YEAR NEW CAR WARRANTY[†]

Mitsubishi Motors Australia Limited offers a 5 year/130,000km (which occurs first) New Vehicle Warranty and a 5 year Perforation Corrosion Warranty on all Mitsubishi cars and light commercial vehicles. Service conditions apply. See your dealer for details.

CAPPED PRICE SERVICING^{*}

Enjoy 'no surprises' certainty when you book your Mitsubishi in for its regular service requirements. Your servicing costs will be capped for the first 4 year or 60,000km of driving (whichever occurs first) up to the first four regular services or eight regular services for Ralliart and Lancer Evolution vehicles. (Conditions apply). Covers all items specified under the standard "Maintenance for normal operating conditions" schedule detailed in the service and warranty booklet. Additional service/repair items (if required) are at additional cost.

CUSTOMER ASSIST

We're here to help. So just call Mitsubishi Motors Australia Limited on 1300 13 12 11 if you have any questions or for the location of your nearest Mitsubishi dealer.

200+ DEALER NETWORK

With a network of more than 200 dealers, Mitsubishi is never too far away.

GENUINE SERVICE

Mitsubishi offers one of Australia's best service intervals of 12 months/15,000 km (whichever comes first). Regular scheduled servicing ensures the long-term reliability and safety of your Mitsubishi and our Scheduled Service Program also helps protect your car's resale value.

FINANCE

Take the burden out of financing your new Mitsubishi vehicle with our competitive range of finance products, developed by Mitsubishi Motors Australia Limited and St. George Motor Finance Limited.

ROADSIDE ASSIST[^]

Peace of mind is guaranteed anywhere in Australia with our Roadside Assist, 24 hours a day, 365 days a year. Our fast, comprehensive roadside service offers assistance, repairs, towing and storage.

GENUINE PARTS

Your Mitsubishi will be serviced regularly by skilled Mitsubishi-trained technicians. Only genuine Mitsubishi parts are fitted to your car during scheduled servicing - parts that have been fully tested and meet Mitsubishi's stringent quality control.

INSURANCE

With the sound backing of Swann Insurance and Mitsubishi Motors Australia Limited, Mitsubishi owners can choose between vehicle and personal protection solutions including motor vehicle, gap cover and loan protection insurance as well as a range of tailored warranty policies.

12MY October 2012

mitsubishi-motors.com.au

Specifications and features may vary by model. Please refer to the Specifications Booklet enclosed or Mitsubishi-motors.com.au for full information.
As features can change without notice, confirm the equipment level of your vehicle with your Mitsubishi dealer. CHA1012. MIT4707.



CHALLENGER

SPECIFICATIONS & FEATURES



love that car



CHALLENGER SPECIFICATIONS

Engine	All models
Type	2.5L Hi-Power 4 cyl, DOHC, 16 valve Common Rail Diesel with Intercooled Turbocharger
Engine code	4D56
Bore x Stroke	91.1mm x 95.0mm
Capacity	2,477cc
Compression Ratio	16.5:1
Maximum Power	131kW @ 4,000rpm
Maximum Torque M/T	400Nm @ 2,000rpm
Maximum Torque A/T	350Nm @ 1,800rpm



2.5L HP Common Rail DI-D Engine

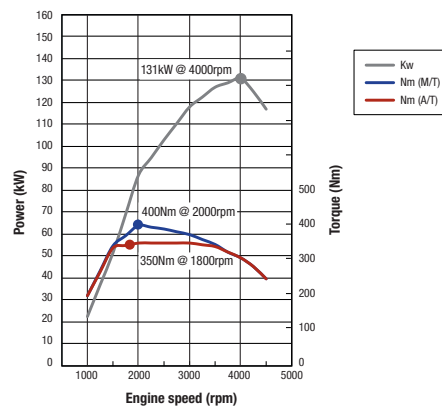

Wheels/Tyres	Challenger 2WD	Challenger 4WD	LS & XLS
Wheels	16" x 7" Alloy wheels	16" x 7.5" Alloy wheels	17" x 7.5" Alloy wheels
Tyres ¹	245/70/R16 112S	265/70/R16 111S	265/65R-17 112S

¹The tyres fitted to Challenger as standard equipment are designed primarily for use on sealed roads. If your Challenger is to be driven on unsealed roads, please consult your Mitsubishi dealer for advice on suitable tyre choices.

Electrical System	
Battery	95D31L
Alternator	12V-90A

Four Wheel Power Assisted Brakes with ABS and EBD	
Front	Ventilated discs, single piston calipers
Rear	Ventilated discs

Suspension	
Front	Independent – Double wishbone coil spring & stabiliser bar
Rear	3-link coil spring & stabiliser bar

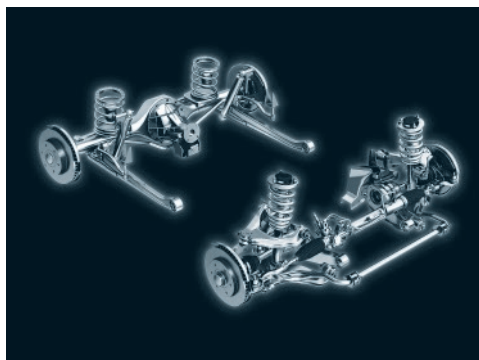

Transmission	Challenger		LS	XLS
	2WD	4WD		
5 speed manual transmission	S	S	S	-
5 speed Sports Mode auto transmission with INVECS II Smart Logic	0	0	0	S
Super Select 4WD	-	S	S	S

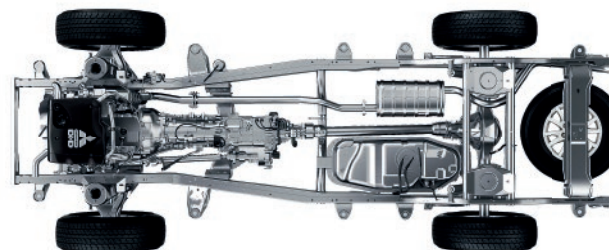

Transmission Ratios	5 speed manual transmission	5 speed Sports Mode auto transmission with INVECS II Smart Logic
first	4.313	3.789
second	2.330	2.057
third	1.436	1.421
fourth	1.000	1.000
fifth	0.788	0.731
reverse	4.220	3.865
Final Gear Ratio	3.917	3.917
Clutch	Dry single disc clutch with diaphragm spring, hydraulic action	3 element torque converter with lock-up and transmission oil cooler

Transfer Ratio	5 speed manual transmission	5 speed Sports Mode auto transmission with INVECS II Smart Logic
High	1.0	1.0
Low	1.9	1.9

Fuel System	5 speed manual transmission 2WD/4WD	5 speed Sports Mode auto transmission with INVECS II Smart Logic 2WD/4WD
Fuel consumption [^] (ADR81/02) litres per 100km	8.2 / 8.3	9.6 / 9.8
Fuel Supply Equipment	Electronic Direct Injection – Common Rail	
Fuel Tank Capacity (L)	70L	

[^]These figures are obtained by controlled laboratory tests conducted by Mitsubishi Motors to Australian Design Rule ADR81/02 and are provided to assist you in comparing the fuel consumption of Challenger with other vehicles. The actual fuel consumption you achieve will depend, however, on many factors, including your driving habits, the prevailing conditions and your vehicle's equipment, condition and use.

CHALLENGER SPECIFICATIONS

Capacities	2WD 5M/T 5 seat	2WD 5A/T 5 seat	4WD 5M/T 5 seat	4WD 5A/T 5 seat	4WD LS 5M/T 5 seat	4WD LS 5A/T 5 seat	4WD LS 5A/T 7 seat	4WD XLS 5A/T 5 seat	4WD XLS 5A/T 7 seat
Gross vehicle mass (kg)	2,610	2,610	2,710	2,710	2,710	2,710	2,710	2,710	2,710
Kerb mass (kg)	1,899	1,910	2,019	2,029	2,041	2,051	2,106	2,059	2,110
Maximum payload (kg)*	711	700	691	681	669	659	609	651	606
Maximum front axle load (kg)*	1,260	1,260	1,260	1,260	1,260	1,260	1,260	1,260	1,260
Maximum rear axle load (kg)*	1,600	1,600	1,600	1,600	1,600	1,600	1,600	1,600	1,600
Gross combination mass (kg)	5,610	5,610	5,650	5,650	5,650	5,650	5,650	5,650	5,650
Towing capacity with trailer brakes (kg)**	3,000	3,000	3,000	3,000	3,000	3,000	3,000	3,000	3,000
Towing capacity without trailer brakes (kg)	750	750	750	750	750	750	750	750	750
Towball download	300	300	300	300	300	300	300	300	300

*Payload includes occupants, fuel and fitted options (if any). The weight of these must be deducted from payload to determine actual load carrying capacity. Front and/or rear axle loads must not be exceeded.

** Subject to state regulations and towbar designs

Cargo Area	5 seat	7 seat option
Cargo dimensions (mm)		
Length – 2nd row seats folded	1,572	1,572
Length – 2nd row seats up	1,017	1,017
Length – 2nd row seat folded & 3rd row seat stowed	N/A	1,572
Length – 2nd row seat upright & 3rd row seat stowed	N/A	1,017
Length – 2nd & 3rd row seat upright	N/A	250
Height	1,027	897
Width	1,375	1,375
Load floor height (from ground)	757	839
Cargo load space 2nd row flat (litres)	1,813	N/A
Cargo load space 2nd/3rd row flat (litres)	N/A	1,649
Cargo load space 3rd row flat (litres)	N/A	866

Interior Dimensions (mm)	5 seat	7 seat
Headroom		
Front row	920	920
2nd row	865	865
3rd row	–	819
Legroom		
Front row	915	915
2nd row	840	840
3rd row	–	830
Steering		
Type	Power assisted rack and pinion steering	
Turning Circle (m)	11.2m	

Exterior Dimensions	2WD	4WD	4WD LS/XLS
Overall height (mm)	1,790	1,800	1,840
Overall length (mm)	4,695	4,695	4,695
Overall width (mm)	1,815	1,815	1,815
Ground clearance (mm)	205	220	220
Track – front (mm)	1,520	1,520	1,520
Track – rear (mm)	1,515	1,515	1,515
Wheelbase (mm)	2,800	2,800	2,800
Approach angle [degrees]	34	36	36
Departure angle [degrees]	24	25	25
Ramp breakover angle [degrees]	22	23	23

4WD DIMENSIONS

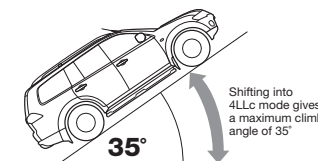
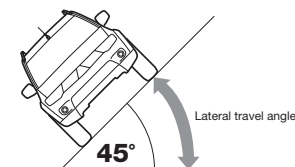
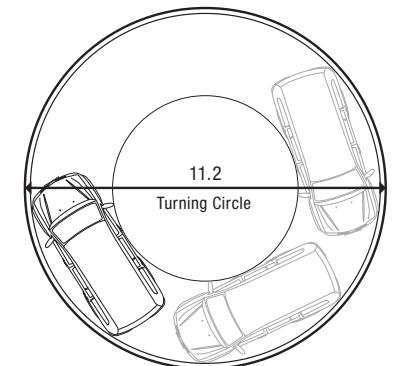
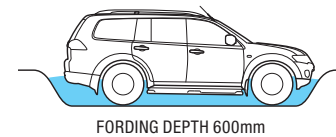
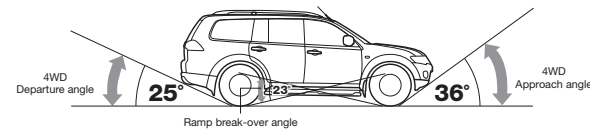
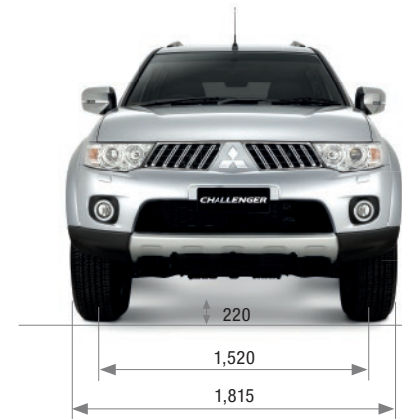
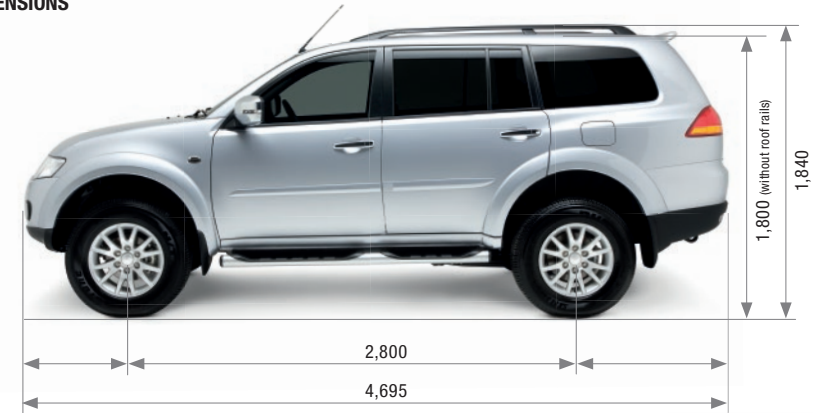

MITSUBISHI CHALLENGER – KEY FEATURES BY MODEL



CHALLENGER - 2WD

Mechanical

2.5L High Power Common Rail Direct Injection Turbo Diesel Engine
5 speed manual transmission
5 speed Sports Mode automatic transmission (optional) with INVECS II Smart Logic
Power steering
Front & rear recovery points

Exterior

16" Alloy wheels
Steel spare wheel
Body coloured fender flares
Front & rear mudflaps
Front skid plate
Side steps

Interior

Door trim cloth inserts
Carpet floor covering

Comfort

Air Conditioning
Pollen filter
Tilt adjustable steering column
Side and rear window demisters
Driver's foot rest
Passenger assist grips (4)
Rear seat heater ducts

Convenience

Cruise control
Central locking with remote keyless entry
Power windows front and rear (driver auto up & down)
Power door mirrors
Variable intermittent windscreen wipers

Intermittent rear wiper and washer
Accessory power socket (2 – cargo & instrument panel)
Front map lamps
Cargo area lamp
Rear passenger reading lamp
Tailgate inside grip
Interior lamp with time delay
Ignition key cylinder illumination
Digital clock display
Driver sunvisor with ticket holder
Passenger sunvisor with vanity mirror
Tachometer
Headlamps on warning
Cigarette lighter
Instrument lamp with variable dimming control
Low fuel warning lamp
Remote fuel filler release

Storage

Glovebox – illuminated and lockable
Floor console with upper and lower storage
Door pockets – front and rear
Cup holders (2)
Bottle holders in front & rear doors
Coat hooks (2)
Seat back pocket – passenger
Cargo tie down hooks – 4¹

Seating

Cloth seat trim
Front seats
Bucket seats
Slide and recline adjustment
Driver height adjustment
Height adjustable headrests

Second row seats
60:40 split folding function
Recline and tumble fold up function adjustment
Centre armrest with cupholders
Height adjustable headrests (3)

Audio & Media

Anti Theft AM/FM radio/CD/MP3 player
4 speakers
Multi function display includes trip computer, outside temperature, and average fuel consumption
Audio input cable

Safety

Driver & front passenger SRS airbags
Multi-mode Anti-lock Braking System (ABS)
Electronic Brakeforce Distribution (EBD)
Power brake booster
Active Stability Control (ASC)
Active Traction Control (ATC)
Reinforced Impact Safety Evolution (RISE) body
Side door impact beams
3 point Emergency Locking Retractor (ELR) seatbelts (all seating positions)
Auto Locking Retractor (ALR) seatbelts on outbound second row seats
Emergency Brake Assist System (BA)
Smart Brake
Front seatbelt pretensioners & force limiters
Front seatbelt height adjustable shoulder anchorages
Seatbelt warning lamp – driver
Child proof rear door locks
Child restraint anchorage points (3)

CHALLENGER - 4WD

Mechanical

Super select 4WD
4WD indicator lamp
Centre differential with viscous coupling unit

Options

Safety Pack

Side & curtain airbags
Roof rails

Off Road Pack

Rear diff lock
Roof rails

Security

Anti-theft encrypted engine immobiliser
Diamond Advantage roadside assistance

Options

Convenience Pack - Auto Only

17" alloy wheels
Leather steering wheel, Park Brake & Gear Shift Lever
Steering wheel audio controls
6 Speaker
Privacy Glass
Body coloured tailgate garnish
Body coloured door mirrors with integrated turn indicators and fold control
Body coloured door handles
Chrome radiator grille
Fog lamps
USB connectivity
Bluetooth® Phone Connectivity²
Climate control
Auto rain sensing wipers
Dusk sensing headlamps
Electrochromatic mirror with reverse camera
Roof rails
Side & curtain airbags

Safety Pack

Side & curtain airbags
Roof rails



LS - 4WD (Features Additional to Challenger 4WD)

Mechanical

Paddle shifts (automatic only)
Rear diff lock

Exterior

17" alloy wheels
Alloy spare wheel
Body coloured door mirrors with turn indicator
Body coloured door handles
Roof rails

Interior

Leather bound steering wheel
Leather bound transmission shift
Leather bound 4WD transfer lever
Chrome inner door handles

Comfort

Automatic climate control air conditioning

Convenience

Power door mirrors with electric folding control
Steering wheel audio controls

Audio & Media

Audio input jack
6 speakers
USB connectivity
Bluetooth® Phone Connectivity²

Safety

Side SRS airbags (driver & front passenger) & curtain SRS airbags
Electrochromatic mirror with reverse camera

Options

Third row seats¹ – Automatic models only

Increase seating capacity to 7
50:50 fold & tumble function
Rear manual control air conditioning
Rear cup holders (2)
Rear underfloor storage

XLS - 4WD (Features Additional to LS)

Mechanical

5 speed Sports Mode automatic
with INVECS II Smart Logic

Exterior

Privacy glass
Chrome door mirrors with turn indicators
Chrome radiator grille
Chrome door handles
Body coloured side protection mouldings
Body coloured licence plate garnish with chrome highlight
Fog lamps
Headlamp washers
Rear spoiler

Interior

Woodprint accent panels
Cargo blind (5 seat model only)
Cargo room net (5 seat model only)
Driver sunvisor with vanity mirror

Seating

Leather seat facings
Power driver and passenger seat with dual height, recline and slide adjustment

Convenience

Rain sensing wipers
Dusk sensing headlamps

Audio & Media

Mitsubishi Power Sound System premium 420 Watt audio with 8 speakers (includes 4 tweeters)

Safety

Reverse parking sensors
High Intensity Discharge (HID) headlamps with auto levelling system

Options

Third row seats¹ – Automatic models only

Increase seating capacity to 7
50:50 fold and tumble function
Rear manual control air conditioning
Rear cup holders (2)
Rear underfloor storage

¹ cargo tie down hooks are not available when seven seat option is selected on LS and XLS models.

² Bluetooth® connectivity depends on your phone compatibility.

STYLE YOUR CHALLENGER

Colours



CHARCOAL (M)*



COOL SILVER (M)*



IRONBARK (M)**#



TERRA ROSSA (M)



DARK BLUE (P)*



WHITE*



BLACK (P)

Interiors



CLOTH SEAT TRIM (2WD, 4WD & LS)



LEATHER SEAT TRIM (XLS)



TAN LEATHER SEAT TRIM (XLS)

METALLIC (M) AND PEARLESCENT (P)
PAINTS ARE OPTIONAL EXTRAS

* NOT AVAILABLE WITH TAN LEATHER
SEAT TRIM

** AVAILABLE ON LS & XLS MODELS ONLY

AVAILABLE ON 2WD OPTION PACK



MITSUBISHI DIAMOND ADVANTAGE

†5 YEAR NEW VEHICLE WARRANTY ♦ ^5 YEAR ROADSIDE ASSIST
***CAPPED PRICE SERVICING ♦ CUSTOMER ASSIST ♦ 200+ DEALER NETWORK**
GENUINE SERVICE ♦ GENUINE PARTS ♦ INSURANCE ♦ FINANCE ♦ PRE-OWNED VEHICLES

†5 year or 130,000km New Vehicle Warranty (whichever comes first). Service conditions apply. ^4 years or 60,000km Capped Price Servicing (whichever occurs first). Covers all items specified under the standard "Maintenance for normal operating conditions" scheduled detailed in the service and warranty booklet. Additional service/repair items (if required) are at additional cost. *1 year Roadside Assist (Service conditions apply). For purchases of new Mitsubishi vehicles after 1st October 2012, your initial 12 month roadside assist will be extended for a period of 12 months from the date of the most recent eligible Capped Price Service for that vehicle performed at an authorised Mitsubishi dealer. Roadside assist, if extended in accordance with these items, is available for a maximum of up to 5 years. Conditions apply. Offer subject to change without notice. Excludes Government, Rental and National Fleet customers.

Always consult your authorised Mitsubishi Dealer for the latest details on specifications, options, prices, availability and conditions on New Vehicle Warranty. All product illustrations and specifications referred to herein are believed to be correct at the time of publication approval. Subject to any applicable Federal, State or Territory Laws or ordinances, which may apply from time to time, Mitsubishi Motors Australia Limited reserves the right, without notice, or obligation, to discontinue or make changes to design, specifications, colours and materials of the options and products referred to herein at any time without incurring any liability to any purchaser thereof. © Mitsubishi Motors Australia Limited. ABN 53 007 870 395. sCHA1012. MIT4708

12MY October 2012

CHALLENGER
GENUINE ACCESSORIES



love that car



ALL ROUND ACCESSORIES

As a genuine all rounder there aren't many places a Challenger won't go. And with our list of genuine accessories, there's no reason why you can't. Talk to your Mitsubishi dealer today.

Mitsubishi Genuine Accessories go through an extensive program of design, development and then stringent testing to ensure they meet all applicable government standards as well as Mitsubishi's own rigorous engineering specifications and performance targets. Using Mitsubishi Genuine Accessories will ensure you get the best quality accessories that are both as durable and reliable as the Mitsubishi you drive.



Headlamp Protectors



Tie Down Straps



Bonnet Protector – Clear or Tinted



Front Air Dam

Front Protection Bar – Alloy
(Pedestrian Safe)



Front Protection Bar – Steel (Pedestrian Safe)



Front Protection Bar – Alloy



Nudge Bar



Front Protection Bar – over bumper



Water Craft & Bike Carrier

Weatherstrips

Fog Lamps



Tow Bar, Tow Ball & Tow Ball Cover



Driving Lights



Fog Lamps



Rear Park Assist Sensors



Towbar Garnish



Rear Air Dam



Rear Garnish



Rear Dust Deflector – Acrylic



Roof Rail Cross Bars



Tow Ball



Luggage Pod



Tail Light Garnish



Rear Spoiler



Weathershields

INTERIOR



Front Seat Covers – Neoprene



Rear Seat Covers – Neoprene



Cargo Barrier – Rear Position only



Outer Scuff Plate with Illumination



Outer Scuff Plate – Stainless Steel



Cargo Liner – Plastic (7 seat)



Reversing Mirror/Camera



Cargo Liner – Plastic (5 seat)



Cargo Mat (5 seat)



Non Slip Boot Grip Mat



Luggage Net



Boot Flap Scuff Guard



Carpet Mats (7 seat also available)



Cargo Mat (7 seat)