

This Brochure is prepared by Daimler AG and it predominantly reflects the capabilities and performance of vehicles sold in Europe. Some characteristics, capabilities performance features and optional extras (e.g. towing systems) may not be available or may not apply in Australia or under Australian conditions. The information in this brochure is therefore indicative, illustrative and provided only for guidance and should not be relied on. To obtain current and accurate information on a vehicle and any options applicable to Australia, contact your local authorized Mercedes-Benz dealer.

B-Class

Sports Tourer



Mercedes-Benz



The B-Class. For the best of what's coming up.

Hit the road. With a Sports Tourer whose agility and comfort make every outing a little journey of adventure. Discover uncharted territories with sustainable, innovative drive systems and, on request, with the dynamic all-wheel drive system 4MATIC. And the optional LED High Performance headlamps show up everything in the very best light. There's so much to be discovered. Are you ready? Your B-Class is waiting.

FOR THE BEST IN EVERY FORMAT.



Experience your B-Class in fascinating HD. With the Mercedes-Benz brochure app for the iPad® and with the Digital Owner's Manual from "Mercedes-Benz Guides" for the iPhone®. Both apps feature a host of films and additional content and are available free of charge from the iTunes Store®.

For the best appearance every time:

2 | Mercedes-Benz B 250 4MATIC

polar silver metallic

AMG Line, AMG 5-twin-spoke light-alloy wheels, Exclusive package, Night package, cranberry red leather upholstery, high-gloss black ash wood trim

14 | Mercedes-Benz B 220 d

jupiter red

Urban equipment line, 5-twin-spoke light-alloy wheels, Night package, black leather upholstery

20 | Mercedes-Benz B 220 d

jupiter red

AMG Line equipment line, AMG 5-twin-spoke light-alloy wheels, AMG Exclusive package, Night package, black RED CUT leather upholstery, carbon-fibre-look trim

For the best in every detail:

24 | Moving innovation

26 | Mercedes me

32 | BlueEFFICIENCY

34 | Natural Gas Drive

36 | Engines

37 | 4MATIC all-wheel drive

38 | Active Parking Assist

39 | Integral safety concept

40 | COMAND Online

42 | Ambient lighting

43 | EASY-VARIO-PLUS system

44 | Equipment and packages

54 | Optional extras

55 | Genuine accessories

56 | Wheels

58 | Technical data

61 | Upholstery and paintwork

The illustrations may show accessories and optional extras which are not part of the standard specification.





A dynamically designed front apron, delicately styled headlamps – and a unique light show which pays as much attention as it draws: in conjunction with the optionally available LED High Performance headlamps the driver is greeted by a blue light when unlocking the doors. Get in and feel good. In a generous interior which is ideally prepared for all activities.

Attractive and cultivated.
Premium pedigree.





For whatever you encounter along the way.

Whether you are on your way to the mountains alone or to the sea with the whole family – the reassuring feeling of driving a Mercedes-Benz accompanies you everywhere. Innovative driving assistance and safety systems support the driver and protect the occupants and other road users. COLLISION PREVENTION ASSIST PLUS, for example, which can warn the driver visually and audibly about an impending rear-end collision and if necessary even initiate braking intervention. That's the B-Class with Mercedes-Benz Intelligent Drive.



LED HIGH PERFORMANCE HEADLAMPS

What is required of light technology in a Mercedes? In particular during journeys at night it must not place excessive strain on the driver's eyes, and it should also be efficient and durable. The optional LED High Performance headlamps get straight to the point. The LED projection technology in the low beam and the LED reflection technology in the high beam provide for optimum illumination of the road. With a pleasant colour temperature which corresponds to that of daylight. And with a splendour befitting a Mercedes.



A silver car is parked on a city street. The car is positioned on the right side of the frame, with its front end facing left. The street is paved with dark asphalt and has white dashed lines. In the background, there is a building with a light-colored facade, a dark door, and a window with a metal grille. The scene is lit with bright sunlight, creating strong shadows on the pavement.

The best motive for
an active “drivestyle”.



Lighting to brighten any mood.

Light contributes considerably to our wellbeing. One more reason to pay it special attention in a Mercedes. In the B-Class the optional ambient lighting creates a unique feel-good atmosphere. Particularly at night, its pleasantly indirect light accentuates the lines and the high-quality materials. The ambient lighting is based entirely on LED technology and offers twelve different colours and five dimmer settings.





A fiery yet restrained statement.

The stylishly coordinated combination of high-quality appointments and materials characterises the optionally available Exclusive package. The 3-spoke multifunction steering wheel is finished in fine leather. The luxury seats with upholstery in leather, for example in cranberry red, add a fashionable flourish and fine highlights with contrasting topstitching.

COLLISION PREVENTION ASSIST PLUS

A little too close, and you're on collision course before you know it. Rear-end collisions are among the most common types of accident in road traffic. Reason enough for Mercedes-Benz to develop COLLISION PREVENTION ASSIST PLUS, a radar-based safety system which can minimise the risk of a rear-end collision or lessen the severity of an accident. And this is how it works: on detecting that the distance to the vehicle in front is inadequate in the speed range between 30 and 250 km/h, the system alerts the driver visually via a warning lamp in the instrument cluster. If the distance continues to lessen, there is an additional acoustic warning. In addition, Adaptive Brake Assist can support the driver's braking in order to prevent a collision. And should the driver not react at all, the system can intervene and reduce the speed via autonomous partial braking.





Keep your distance.
Stay ahead.

Because the best is coming up.

B for best value: Systematically optimised aerodynamics resulting in a C_d value of only 0.25* reduce fuel consumption substantially. Another shining example of environmental compatibility is the B 200 c, which is streets ahead of the competition in its class with the extremely efficient Monovalent Plus natural gas drive.



* B 180 d BlueEFFICIENCY Edition with wheel R00.





The best perspective.







Captured on camera: the sporty AMG Line with the Night package. Powerful: the AMG bodystyling with the front and rear apron, side sill panels and high-sheen AMG light-alloy wheels. The Night package makes a striking impression with selected design elements in high-gloss black, such as the radiator trim with two black louvres and chrome inserts plus the bumpers featuring chrome.

Breathtaking prospects.

With the optional AMG Exclusive package adding a special touch of exclusivity and individuality, the entire interior is literally on red alert. On the upholstery in black RED CUT leather, the dashboard and the door centre panels in ARTICO man-made leather and the multifunction sports steering wheel in leather with a flattened bottom section – red contrasting topstitching adds striking sporty highlights throughout.



What makes a car a Mercedes?

Deep-rooted traditions: in our case, it is innovative traditions that run deep. We have continually gone down previously uncharted avenues. Milestone by milestone. These ventures spawned the first vehicle with a crumple zone, the first ABS, the first diesel passenger car. The first car. But rather than wallowing in the past, let us look to the future.

Mercedes-Benz Intelligent Drive – on the road to accident-free driving. We develop intelligent assistance systems which actively support the driver and noticeably relieve their workload. They monitor and analyse the vehicle's surroundings and handling characteristics – and warn the driver if they identify any critical situations. When necessary, some of the systems are able to intervene to take corrective action. Potential dangers are identified earlier than ever – and ever more frequently avoided as a result. Discover the fascinating world of Mercedes-Benz Intelligent Drive at www.mercedes-benz-intelligent-drive.com

BlueEFFICIENCY – our vision of emission-free driving. Sustainability is a big word to which we lend real meaning in all that we do, down to the smallest details. From minimising the environmental impact of our production operations to alternative drive configurations.

30! years 4MATIC

4MATIC – driven by new challenges, the vision of optimum traction led the Mercedes-Benz engineers to the International Motor Show in Frankfurt. That is where, in 1985, they unveiled 4MATIC, an innovative traction system working with state-of-the-art microelectronics and hydraulics. Just two years later it entered series production in the E-Class. It has continued its triumphal advance ever since in virtually all model series. And on every terrain. 75 models are now out on the road with 4MATIC and it is tailor-made for each class. Comfortable and efficiently configured for the compact class, right through to extremely sporty for the Mercedes-AMG performance models. For more safety and an intensive driving experience in every single moment.

As you can see, we have major goals in our sights. And what could be better than seeing these aims achieved whilst on a long drive in a Mercedes?





What would motorsport be without Mercedes-Benz?

The first vehicle ever to win an automobile race was powered by a Daimler engine. The first Mercedes was a racing car. The Silver Arrows – a true legend. Mercedes-Benz has a long tradition of involvement with the world of sport. Motorsport shapes the brand and every vehicle bearing the Mercedes star to this day. Discover the brand's unique history first-hand: at the Mercedes-Benz Museum in Stuttgart.

↘ FIND OUT MORE

Discover just what has been moving the world for more than 125 years and take a journey through time as well as through the history of the automobile at the Mercedes-Benz Museum. More than 1500 exhibits await you on 16,500 sqm of floor-space, including unique gems such as the oldest surviving Mercedes from 1902 or the legendary gull-wing models. Welcome to a place of innovation:

www.mercedes-benz-classic.com/museum



What would Mercedes-Benz be without motorsport?

3 June 1934 marked the beginning of the Silver Arrows legend in the International Eifel Race at the Nürburgring. The Silver Arrows works team MERCEDES AMG PETRONAS continued this tradition in the 2014 Formula 1 season. Its successful involvement was crowned by the most impressive double victory of the season, with the team topping both the constructors' and the drivers' rankings. The team's successes are not restricted to the race track, however. Every mile raced also advances the development of hybrid technology for series production.

▾ FIND OUT MORE

Fascinating Formula 1 goes multimedia:

<http://www.facebook.com/MercedesAMGF1>

<http://twitter.com/MERCEDESAMGF1>

<http://www.youtube.com/user/MERCEDESAMGPETRONAS>

<http://plus.google.com/+Mercedesamgf1/posts>

<http://instagram.com/MercedesAMGF1#>

<http://www.MercedesAMGF1.com>



MERCEDES AMG PETRONAS F1 W06 hybrid, 2015 season.



Driving ambition.

Extremely efficient diesel and petrol engines are available for the B-Class in a total of nine output ratings. All engine variants are turbocharged and feature the ECO start/stop function as standard. There is also an alternative drive configuration for particularly environmentally friendly mobility in the form of the Monovalent Plus natural gas drive in the B 200 c (see the previous double page).

Depending on the engine, the power transmission is via a 6-speed manual transmission or the 7G-DCT automatic dual clutch transmission, which changes gear particularly smoothly and virtually without any interruption in tractive power.

▾ FIND OUT MORE

The full technical data for the B-Class can be found on page 58/59.

THE ENGINE RANGE

Diesel:

B 160 d with an output of 66 kW (90 hp) and 240 Nm of torque

B 180 d/B 180 d BlueEFFICIENCY Edition with an output of 80 kW (109 hp) and 260 Nm of torque

B 200 d/B 200 d 4MATIC with an output of 100 kW (136 hp) and 300 Nm of torque

B 220 d/B 220 d 4MATIC with an output of 130 kW (177 hp) and 350 Nm of torque

Petrol:

B 160 with an output of 75 kW (102 hp) and 180 Nm of torque

B 180/B 180 BlueEFFICIENCY Edition with an output of 90 kW (122 hp) and 200 Nm of torque

B 200 with an output of 115 kW (156 hp) and 250 Nm of torque

B 220 4MATIC with an output of 135 kW (184 hp) and 300 Nm of torque

B 250/B 250 4MATIC with an output of 155 kW (211 hp) and 350 Nm of torque



On the gripping subject of traction. 4MATIC all-wheel drive.

Specially developed for the B-Class platform. In normal conditions as efficient as front-wheel drive, but with tangibly more traction in the wet or snow: **4MATIC all-wheel drive** for the B-Class.

An electrohydraulically controlled multiple-disc clutch integrated in the rear axle differential enables variable torque distribution. This ranges from particularly economical front-wheel drive only, e.g. for steady motorway driving, to a 50 : 50 split on snow or slippery road surfaces or in dynamic driving manoeuvres.

FASCINATING SUSPENSION AND STEERING TECHNOLOGY

A good balance between comfort and dynamism is offered by the **comfort suspension**. Low levels of rolling and pitching improve vehicle control and handling safety.

The **suspension with Adaptive Damping System** enables the driver to alter the vehicle's damping characteristics via the **DYNAMIC SELECT switch**. Switching from comfort to sport mode increases the lateral dynamics and provides for a particularly intensive driving experience.

The **lowered comfort suspension** combines ride comfort and agility. Lowering the body by 20 mm at the front and 15 mm at the rear improves aerodynamics.

Speed-sensitive steering provides variable power assistance according to the vehicle's speed. At high speeds the servo assistance is reduced; at lower speeds it is continually increased.

The **Sports Direct-Steer system** adds to the comfort of speed-sensitive power steering with a variable ratio dependent on the steering angle. On winding roads, for example, this produces a more agile handling response and improved straight-line stability.

Introducing your personal assistants.

The optional **Active Parking Assist with PARKTRONIC** makes it easier to find a parking space and also to enter or leave parking spaces. On request it automatically steers the car into parallel and perpendicular parking spaces.¹ Active Parking Assist is automatically switched on when driving forwards up to 35 km/h and flags up suitable parking spaces. When the driver engages reverse gear and confirms the suggested parking space, Active Parking Assist automatically carries out the steering manoeuvres up to a speed of 10 km/h.

¹ Applies to automatic vehicles only.

VERY ATTENTIVE: FURTHER OPTIONAL ASSISTANTS

The **reversing camera** is activated automatically when reverse gear is engaged and shows the driver the area behind the vehicle on the Media Display together with dynamic guide lines.

The optional **Traffic Sign Assist** system is able to recognise speed limits, no-entry and no-overtaking signs and the end of such restrictions, and display them to the driver.

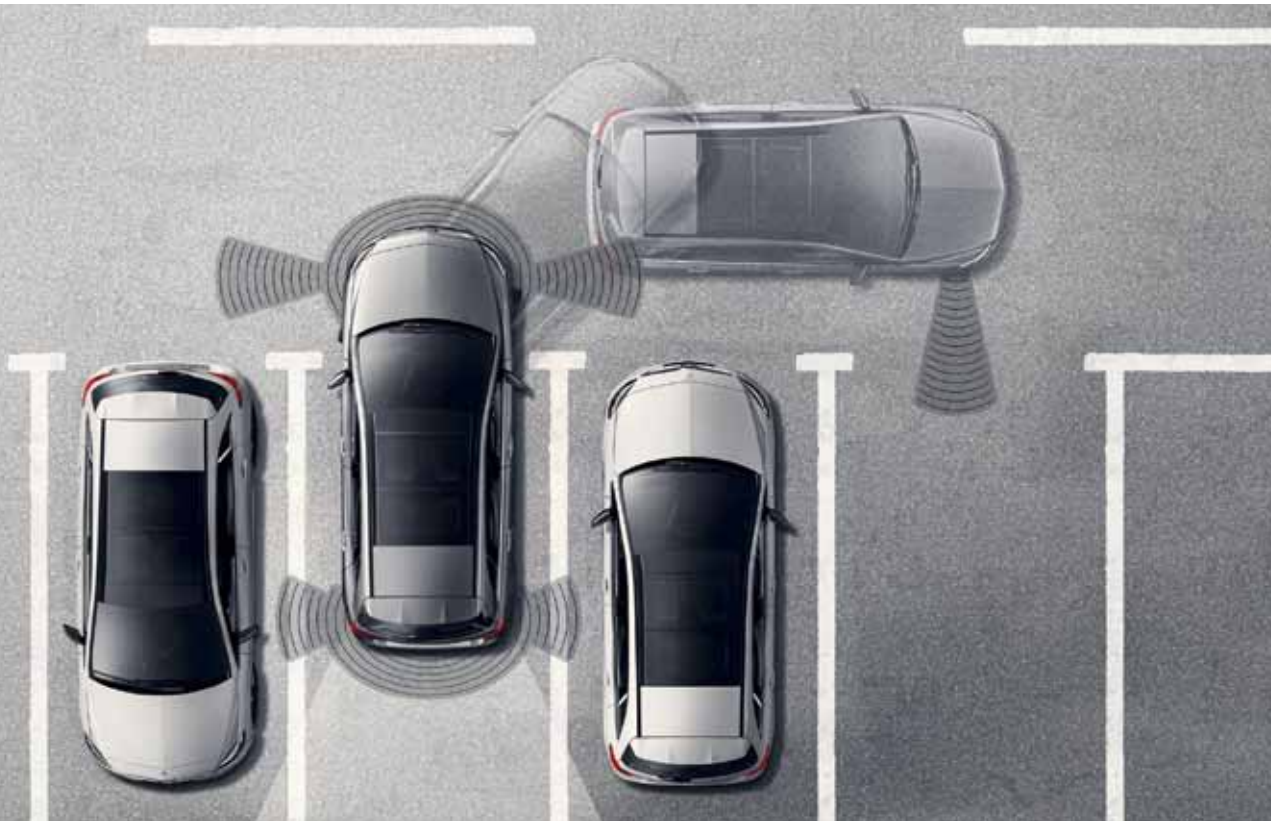

The reassuring feeling of driving a Mercedes-Benz.

We are the first automotive manufacturer worldwide to have developed an **integral safety concept**, aimed at avoiding accidents, ensuring ideal responses to dangers and lessening the consequences of accidents. For the occupants of a Mercedes and for all other road users, too.

SAFE DRIVING

The **drowsiness detection system ATTENTION ASSIST** serves to enhance driving safety, in particular on long trips and during night-time driving. It can monitor the driver's steering behaviour to detect typical signs of drowsiness and severe loss of attention, and give a visual and audible warning of impending microsleep.

The **ADAPTIVE BRAKE** control system improves braking performance through intelligent intervention: in wet conditions, the brake discs are kept dry. The brake pads are applied automatically when the driver's foot is removed abruptly from the accelerator pedal. And on uphill slopes, the system is able to prevent the vehicle from rolling backwards.

The optional **DISTRONIC PLUS proximity control** system helps to maintain a safe distance from the vehicle ahead above all in stop-and-go traffic. The system is able to brake the vehicle automatically and subsequently accelerate again as appropriate to the traffic situation. On detecting a threat of a rear-end collision, **COLLISION PREVENTION ASSIST PLUS** is able to warn the driver. If the driver fails to react, it can initiate autonomous partial braking in order

to avoid a collision or to lessen the consequences of a collision.

The optional **Blind Spot Assist** system employs radar sensors and can draw attention to one of the most serious sources of danger in road traffic. When a vehicle is detected in the blind spot, a red triangle lights up in the exterior mirror. An acoustic warning additionally sounds as necessary. The system is active at speeds between 30 and 250 km/h. The optional **Lane Keeping Assist** system is able to recognise when the vehicle is unintentionally drifting out of its lane at speeds between 60 and 200 km/h, duly warning the driver by means of pulsed vibrations on the steering wheel. Blind Spot Assist and Lane Keeping Assist also form part of the optional **Lane Tracking package**.

IN THE EVENT OF DANGER

The optional **PRE-SAFE®** occupant protection system is able to identify critical driving situations in advance and to initiate precautionary measures to protect the vehicle's occupants if an accident appears imminent. Such measures include reversible belt tensioning or automatic closing of open side windows, for example.

IN AN ACCIDENT

In an accident, the intelligently coordinated restraint systems and the structure of the vehicle's bodyshell make an effective contribution towards optimum protection for the vehicle's occupants. These systems comprise the seat belts and the following airbags: front airbags for the driver and front passenger, each triggered in two stages depending on the registered severity of impact, sidebags for the driver and front passenger, windowbags between the A- and C-pillars, a kneebag for the driver plus optional sidebags in the rear.

AFTER AN ACCIDENT

Every Mercedes-Benz is fully trained in first aid. If the worst comes to the worst, the engine can be stopped automatically, the hazard warning lights and emergency interior lighting can be activated and the central locking can be unlocked. Finally, the **Mercedes-Benz emergency call system** (country-specific) can send GPS position data and important vehicle information – though this will hopefully never be necessary.



The internet has changed our lives. Now it is changing the world of driving, too.

Navigation, telephone, audio, video, internet – all this is presented in high resolution by the optional **COMAND Online** control and display system on a 20.3 cm (8") display. Fast hard-disc navigation with realistic map display for stress-free route guidance. With a suitable mobile phone, it is possible to call up internet sites when the vehicle is stationary and to use Mercedes-Benz Apps while out and about. Other COMAND Online highlights include the LINGUATRONIC voice-operated control system, a Bluetooth® interface with hands-free function, text message reading function and music transfer via audio streaming.

FURTHER INFOTAINMENT OPTIONS

The additional **Live Traffic Information** option (part of COMAND Online, also in conjunction with Garmin® MAP PILOT) enables traffic information to be received in real time. The route guidance is continuously optimised and the arrival time is calculated with extreme precision.

Optional **Traffic Sign Assist** is able to identify speed limits and no-overtaking signs and to detect when the vehicle is travelling in the wrong direction.

With twelve loudspeakers, including a woofer, and a 9-channel DSP amplifier, the 450 W **Harman Kardon® Logic 7® surround sound system** combines with audio systems to serve up a superlative listening experience.

With the **Garmin® MAP PILOT** Audio 20 CD becomes an intuitive and voice-controlled navigation system with high-resolution map data and excellent route guidance.

Smartphone integration enables the screen on your smartphone to be duplicated on the Media Display via a USB connection – including navigation option, telephone, music and message functions.



The ambient lighting bids you a warm welcome.

Climb in and feel at home – with its pleasant, indirect light the **ambient lighting** available in combination with the optional Light and Sight package creates a real sense of wellbeing throughout the entire interior. Especially at night, it accentuates the contouring and high quality of the interior design, imparts a feeling of security thanks to an impression of generous spaciousness and reduces dazzle from oncoming traffic. Twelve different colours and five dimming levels are available to create the desired lighting mood. The ambient lighting features full LED technology and is conveniently controlled via the instrument cluster. It also switches on when the doors are opened, welcoming the passengers on board.

MORE LIGHT, PLEASE

The optional **Light and Sight package** provides a higher quality feel for the interior and optimum visibility in the car. It comprises the single-tone ambient lighting, function illumination and a rain sensor for the windscreen wipers.

The optional brushed stainless-steel **door sill panels** add sporty exclusive highlights with their illuminated “Mercedes-Benz” lettering. They also protect the entrance area from damage.

The **ambient lighting** greets you with an uplifting play of colour as soon as you open the doors.





Reassuringly stylish: the Style line.

Whether you are cruising the boulevards or exploring the countryside, these perfectly matched stylish design and comfort features exude self-assurance and individuality.

EXTERIOR HIGHLIGHTS

10-spoke light-alloy wheels with 205/55 R 16 (55R) tyres

7-twin-spoke light-alloy wheels with 205/55 R 16 tyres (R27, for B 200 c)

Radiator trim with two louvres painted in iridium silver and chrome inserts

Beltline trim strip in chrome

Long chrome trim strip on the rear bumper

INTERIOR HIGHLIGHTS

Seats with accentuated shoulder area and Vianen fabric upholstery

Seat Comfort package, including seat cushion length adjustment with a 60 mm wider surface for the thighs

Line-pattern trim

3-spoke multifunction steering wheel with twelve function buttons

Shift lever featuring use of silver-chrome trim

Instrument cluster with 11.4 cm (4.5-inch) TFT colour multifunction display

High-gloss black light switch with ring in silver chrome





Inspiringly progressive: the Urban line.

Take in the sights in your urbane Mercedes. Exceptional design is everywhere you look, while the interior offers a highly individual style.

EXTERIOR HIGHLIGHTS

5-spoke light-alloy wheels with 225/45 R 17 (R04) tyres

Multi-spoke light alloy wheels with 225/55 R 17 tyres (08R, for B 200 c)

Radiator trim with two louvres painted in iridium silver and chrome inserts

Two-pipe exhaust system with tailpipes in chrome look (except for B 200 c)

Beltline trim strip in chrome

Short chrome trim strip on the rear bumper

INTERIOR HIGHLIGHTS

Seats with accentuated shoulder area and upholstery in ARTICO man-made leather/Montfort fabric with contrasting topstitching

Seat Comfort package, including seat cushion length adjustment with a 60 mm wider surface for the thighs

3-spoke multifunction steering wheel in leather, with perforated grip area and twelve control buttons, topstitching and trim in silver chrome

Shift lever in perforated leather with contrasting topstitching and use of silver-chrome trim

Instrument cluster with silver-coloured round dials and red needles, plus 11.4 cm (4.5-inch) TFT colour multifunction display

Roof liner in black fabric (optionally roof liner in crystal grey fabric)



AMG Line.

Take your B-Class to the sporting pinnacle in terms of looks, driving feel and exclusivity. The AMG Line design and equipment line comprises extensive AMG bodystyling and further measures for enhancing driving dynamics. In the interior, too, which presents itself in a decidedly sporty guise.

EXTERIOR HIGHLIGHTS

AMG bodystyling with front and rear apron plus side sill panels

AMG 5-twin-spoke light-alloy wheels, painted titanium grey and with a high-sheen finish, with 225/40 R 18 tyres (794)

Radiator trim with two louvres painted in iridium silver with chrome inserts

Two-pipe exhaust system with tailpipes in chrome look

Lowered comfort suspension and Sports Direct-Steer system

Perforated front brake discs

Brake callipers with "Mercedes-Benz" lettering at the front

INTERIOR HIGHLIGHTS

Seats with accentuated shoulder area and upholstery in ARTICO man-made leather/black DINAMICA microfibre with contrasting topstitching

Seat Comfort package, including seat cushion length adjustment with a 60 mm wider surface for the thighs

Carbon-fibre-look trim

3-spoke multifunction sports steering wheel in leather, with flattened bottom section, perforated in the grip area and with red contrasting topstitching

Shift lever in perforated leather with red contrasting topstitching and use of silver-chrome trim

Brushed stainless-steel sports pedals with rubber studs





Exclusive package.

The stylishly coordinated combination of select interior appointments meets very high expectations with regard to comfort, quality and design. The highlights include heated front seats with 4-way lumbar support, which are covered in fine leather to match the multifunction steering wheel and gearshift lever. The dashboard and the door centre panels are finished in matching ARTICO man-made leather. Design features in silver chrome and trim in open-pore eucalyptus wood or high-gloss black ash also contribute to the exclusive ambience.

AMG Exclusive package.

Building on the AMG Line, this equipment package offers maximum exclusivity, individuality and sportiness. Highlights include the heated seats with 4-way lumbar support, which make a striking impression with their RED CUT black leather upholstery with red contrasting topstitching. To match these seats, the dashboard and the door centre panels are finished in ARTICO man-made leather, as are the armrests in the doors. The multifunction sports steering wheel in leather with flattened bottom section and perforated grip area, together with the shift lever in perforated leather, feature a look and feel that underscores the interior's sporty character. The red contrasting topstitching is to be found on all these features, indicating a loving attention to detail.



Night package.

The Night package offers striking exterior features to lend the vehicle an expressive sporty character. These include selected design features in black. The radiator trim boasts two louvres in high-gloss black and chrome inserts. Also in black are the high-shine 5-twin-spoke 45.7 cm (18-inch) light-alloy wheels, the exterior mirror housings and the shoulderline trim strips. Dark-tinted heat-insulating glass from the B-pillar to the rear shields the interior from prying eyes while underscoring the vehicle's sporty character.

Optional extras.

There are endless ways of adding your very own personal touch to the B-Class. From small details to comfort features which until recently were the reserve of the luxury segment. Take your time to browse around – in this catalogue, by reference to the price list or online. A convenient means of configuring your B-Class is available on the national website for your own country, accessible via www.mercedes-benz.com.



1 In addition to their distinctive look, the **LED High Performance headlamps**¹ boost night-time driving safety thanks to broad light distribution, a daylight-simulating colour temperature, and low energy consumption. The “Coming Home” function welcomes the driver with an exceptional light display from blue to white when they unlock the car. The tail lights feature LED technology and create a visual highlight while improving visibility.

2 **KEYLESS-GO**: The vehicle can be conveniently unlocked, started and locked with this access and drive authorisation system – simply by carrying the electronic key.

3 When not in use, the **trailer coupling**² can be folded out of the way behind the rear bumper. The coupling hitch is simply folded out to attach a car trailer or mount a bicycle carrier. A control with LED in the luggage compartment serves to release the coupling.

4 **Panoramic sliding sunroof**: With its large glazed areas, this roof system ensures a particularly bright and welcoming ambience in the interior. The rear part consists of a fixed panoramic glass sunroof while the front part is an electrically operated glass sliding sunroof.

¹ Optional extra LED High Performance headlamps not available for B 200 c.

² Also available in combination with AMG Line.



Genuine accessories.

The B-Class leaves very little to be desired. And for those extra special needs there are genuine accessories. These cover almost every conceivable need for more pleasant and individual motoring. Every accessory has been developed specifically for the B-Class in accordance with Mercedes-Benz's high quality standards.

- 1 Rear-mounted bicycle rack for trailer coupling, folding.** The lockable rear-mounted bicycle rack for the safe and secure transportation of up to three bicycles is very simple to fit on the trailer coupling. And fixing your bikes on the racks is equally simple. Maximum load of up to 30 kg per bicycle rail - making the rack suitable for most e-bikes. Thanks to an ingenious roller mechanism, the boot can still be opened.
- 2 Let your Mercedes star shine brightly.** The star centred in the radiator grille of your Mercedes will light up courtesy of fibre optics and LED technology when the vehicle is unlocked by remote control and when a door or the boot lid is opened. Functionality only when the engine is switched off, not in conjunction with DISTRONIC (code 233).
- 3 Boot tub, shallow.** Produced in impact-resistant polypropylene with an anti-slip effect. Protects your boot floor from dirt and is designed to fit perfectly into your boot. Suitable for transporting foodstuffs.
- 4 Ski and snowboard rack New Alustyle "Comfort".** Fits the anchorage on your basic carrier. For up to six pairs of skis* or four snowboards, lockable.

↳ DISCOVER THE ENTIRE RANGE

Now online at www.mercedes-benz-accessories.com

* Depending on the ski geometry.





Wheels.

Wheels are indispensable on technical grounds, of course. But on an emotional level, too, perfect wheels are an absolutely crucial ingredient of many people's dream car. With this in mind, we have put together a particularly large and diverse selection for you.

STANDARD EQUIPMENT AND OPTIONAL EXTRAS

R00 Steel wheel with 10-hole wheel trim with 195/65 R 15 tyres (standard for B 160 d, B 180 d BlueEFFICIENCY Edition, B 180 d, B 180 BlueEFFICIENCY Edition and B 180)

643 Steel wheel with 10-hole wheel trim with 205/55 R 16 tyres (standard for B 200 d, B 220 d, B 200, B 220 4MATIC and B 200 c; option for B 160 d, B 180 d BlueEFFICIENCY Edition, B 180 d, B 180 BlueEFFICIENCY Edition and B 180)

55R 10-spoke light-alloy wheel with 205/55 R 16 tyres (part of Style equipment line except for B 200 c; option for all models apart from B 200 d 4MATIC, B 220 d 4MATIC, B 250, B 250 4MATIC and B 200 c)

R27 7-twin-spoke light-alloy wheel, painted in vanadium silver, with 205/55 R 16 tyres (part of Style equipment line for B 200 c)

R78 5-twin-spoke light-alloy wheel, painted matt black and with a high-sheen finish, with 205/55 R 16 tyres (option for all models except B 200 d 4MATIC, B 220 d 4MATIC, B 250, B 250 4MATIC and B 200 c)

R43 10-spoke light-alloy wheel with 225/45 R 17 tyres (standard for B 200 d 4MATIC, B 220 d 4MATIC, B 250 and B 250 4MATIC; option for all other models except BlueEFFICIENCY Edition models and B 200 c)

R04 5-spoke light-alloy wheel, painted in silver, with 225/45 R 17 tyres (part of Urban equipment line except for BlueEFFICIENCY Edition models and B 200 c)

08R Multi-spoke wheel with 225/55 R 17 tyres (part of Urban design and equipment line for B 200 c)

R15 5-twin-spoke light-alloy wheel, painted in himalayas grey, with 225/45 R 17 tyres (option for all models apart from BlueEFFICIENCY Edition models, not in conjunction with Night package and AMG Line)



26R



01R



678



646



R69



791



612

25R 10-spoke light-alloy wheel, painted in vanadium silver, with 205/50 R 17 tyres (option for all models except BlueEFFICIENCY Edition models and B 200 c)

26R 7-twin-spoke light-alloy wheel with 225/45 R 17 tyres (option for all models except BlueEFFICIENCY Edition models and B 200 c)

R69 5-spoke light-alloy wheel, painted black and with a high-sheen finish, with 225/45 R 17 tyres (option, not in conjunction with AMG Line and Night package and not for BlueEFFICIENCY Edition models)

01R 5-twin-spoke light-alloy wheel, painted black and with a high-sheen finish, with 225/40 R 18 tyres (standard in conjunction with Night package; Option for all models except BlueEFFICIENCY Edition models and B 200 c)

791 AMG multi-spoke light-alloy wheel, painted in titanium grey and with a high-sheen finish, with 225/40 R 18 tyres (option, not in conjunction with Night package and not for BlueEFFICIENCY Edition models and B 200 c)

678 AMG 5-twin-spoke light-alloy wheel, painted in titanium grey and with a high-sheen finish, with 225/40 R 18 tyres (part of AMG Line, not in conjunction with Night package and not for BlueEFFICIENCY Edition models and B 200 c)

612 AMG 5-twin-spoke light-alloy wheel, painted black and with a high-sheen finish, with 225/40 R 18 tyres (standard for AMG Line in conjunction with Night package; option for all models except BlueEFFICIENCY Edition models and B 200 c)

646 AMG multi-spoke light-alloy wheel, painted black with rim flange in a high-sheen finish, with 225/40 R 18 tyres (option for all models except BlueEFFICIENCY Edition models and B 200 c)

↘ FURTHER WHEELS

can be found in our accessories range.

Information about Mercedes-Benz Genuine Accessories is available at www.mercedes-benz-accessories.com or directly from your authorised Mercedes-Benz dealer.

Technical data.

DIESEL ENGINES

	B 160 d	B 180 d	B 180 d BE Edition	B 200 d	B 200 d 4MATIC	B 220 d	B 220 d 4MATIC
No. of cylinders/arrangement	4/in-line	4/in-line	4/in-line	4/in-line	4/in-line	4/in-line	4/in-line
Total displacement in cc	1461	1461	1461	2143	2143	2143	2143
Rated output ¹ in kW (hp) at rpm	66 (90)/2750-4000	80 (109)/4000	80 (109)/4000	100 (136)/3200-4000	100 (136)/3400-4400	130 (177)/3600-3800	130 (177)/3600-3800
Rated torque ¹ in Nm at rpm	240/1700-2500	260/1750-2500	260/1750-2500	300/1400-3000	300/1400-3000	350/1400-3400	350/1400-3400
Transmission	6-speed, man. [7G-DCT]	6-speed, man. [7G-DCT]	6-speed, man. [-]	6-speed, man. [7G-DCT]	- [7G-DCT]	- [7G-DCT]	- [7G-DCT]
Acceleration from 0 to 100 km/h in s [7G-DCT]	14.0 [13.8]	11.6 [11.9]	11.6 [-]	9.4 [8.9]	- [8.9]	- [8.3]	- [7.6]
Top speed, approx. in km/h [7G-DCT]	180 [180]	190 [190]	190 [-]	210 [210]	- [207]	- [224]	- [220]
Tyre size, front	195/65 R 15	195/65 R 15	195/65 R 15	205/55 R 16	225/45 R 17	205/55 R 16	225/45 R 17
Tyre size, rear	195/65 R 15	195/65 R 15	195/65 R 15	205/55 R 16	225/45 R 17	205/55 R 16	225/45 R 17
Fuel	Diesel	Diesel	Diesel	Diesel	Diesel	Diesel	Diesel
Fuel consumption ² in l/100 km							
Urban [7G-DCT]	4.9-4.6 [4.7-4.4]	4.9-4.6 [4.7-4.4]	4.1 [-]	5.5-5.3 [4.9-4.7]	- [5.9-5.8]	- [5.0-4.9]	- [5.9-5.8]
Extra-urban [7G-DCT]	4.0-3.6 [4.1-3.7]	4.0-3.6 [4.1-3.7]	3.3 [-]	3.9-3.5 [3.8-3.5]	- [4.5]	- [3.8-3.6]	- [4.5]
Combined [7G-DCT]	4.4-4.0 [4.3-4.0]	4.4-4.0 [4.3-4.0]	3.6 [-]	4.5-4.2 [4.2-4.0]	- [5.0]	- [4.3-4.1]	- [5.0]
CO ₂ emissions ² in g/km, combined [7G-DCT]	113-104 [113-104]	113-104 [113-104]	94 [-]	117-109 [111-104]	- [131-130]	- [111-107]	- [131-130]
Emission class ³ /efficiency class ⁴ [7G-DCT]	Euro 6/A [Euro 6/A+]	Euro 6/A [Euro 6/A+]	Euro 6/A+ [-]	Euro 6/A [Euro 6/A+]	- [Euro 6/B]	- [Euro 6/A+]	- [Euro 6/B]
Tank capacity, of which reserve, approx. in l	50/6.0	50/6.0	40/6.0	50/6.0	56/6.0	50/6.0	56/6.0
Luggage compartment capacity ⁵ in l	488-1547	488-1547	488-1547	488-1547	488-1547	488-1547	488-1547
Turning circle diameter in m	11.0	11.0	11.0	11.0	11.0	11.0	11.0
Kerb weight ⁶ in kg [7G-DCT]	1420 [1450]	1420 [1450]	1410 [-]	1485 [1505]	- [1575]	- [1505]	- [1575]
Perm. GVW in kg [7G-DCT]	1985 [1985]	1985 [1985]	1900 [-]	2025 [2025]	- [2095]	- [2025]	- [2095]

The best for the engine:
Mercedes-Benz genuine engine oils.

¹ Details of rated power and rated torque in accordance with Directive 80/1269/EEC in the currently applicable version. ² The figures shown were obtained in accordance with the prescribed measuring process (Regulation [EC] 715/2007 in the currently applicable version). Note according to Directive 1999/94/EC in the currently applicable version: The figures are not based on an individual vehicle and do not constitute part of the product offer; they are provided solely for purposes of comparison between different vehicle models. ³ Data applicable within the European Union only. May vary from country to country. ⁴ Determined on the basis of the measured CO₂ emissions, taking into account the mass of the vehicle.

PETROL ENGINES

	B 160	B 180	B 180 BE Edition	B 200	B 200 c	B 220 4MATIC	B 250	B 250 4MATIC
No. of cylinders/arrangement	4/in-line	4/in-line	4/in-line	4/in-line	4/in-line	4/in-line	4/in-line	4/in-line
Total displacement in cc	1595	1595	1595	1595	1991	1991	1991	1991
Rated output ¹ in kW (hp) at rpm	75 (102)/4500-6000	90 (122)/5000	90 (122)/5000	115 (156)/5300	115 (156)/5000	135 (184)/5500	155 (211)/5500	155 (211)/5500
Rated torque ¹ in Nm at rpm	180/1200-3500	200/1250-4000	200/1250-4000	250/1250-4000	270/1250-4000	300/1200-4000	350/1200-4000	350/1200-4000
Transmission	6-speed, man. [7G-DCT]	6-speed, man. [7G-DCT]	6-speed, man. [-]	6-speed, man. [7G-DCT]	6-speed, man. [7G-DCT]	- [7G-DCT]	6-speed, man. [7G-DCT]	- [7G-DCT]
Acceleration from 0 to 100 km/h in s [7G-DCT]	10.7 [10.6]	9.0 [8.7]	9.0 [-]	8.2 [7.9]	9.2 [9.1]	- [7.0]	6.6 [6.5]	- [6.5]
Top speed approx. in km/h [7G-DCT]	190 [190]	200 [200]	190 [-]	220 [220]	200 [200]	- [225]	240 [240]	- [235]
Tyre size, front	205/55 R 16	205/55 R 16	195/65 R 15	205/55 R 16	205/55 R 16	205/55 R 16	225/45 R 17	225/45 R 17
Tyre size, rear	205/55 R 16	205/55 R 16	195/65 R 15	205/55 R 16	205/55 R 16	205/55 R 16	225/45 R 17	225/45 R 17
Fuel	Premium petrol	Premium petrol	Premium petrol	Premium petrol	Nat. gas H/prem. petr.	Premium petrol	Premium petrol	Premium petrol
Fuel consumption ² in l/100 km								
Urban [7G-DCT]	7.2 [7.0-6.9]	7.6-7.4 [7.0-6.9]	7.0 [-]	7.6-7.4 [7.0-6.9]	6.0 [5.7-5.6] ⁷	- [8.4]	8.8-8.6 [8.6-8.5]	- [8.4]
Extra-urban [7G-DCT]	4.6-4.4 [4.8-4.5]	4.8-4.5 [4.8-4.5]	4.2 [-]	4.8-4.6 [4.8-4.5]	3.5-3.4 [3.5] ⁷	- [5.7-5.4]	5.5-5.3 [4.7-4.6]	- [5.7-5.5]
Combined [7G-DCT]	5.6-5.5 [5.6-5.4]	5.8-5.6 [5.6-5.4]	5.2 [-]	5.8-5.7 [5.6-5.4]	4.4 [4.3-4.2] ⁷	- [6.7-6.5]	6.8-6.6 [6.1]	- [6.7-6.6]
CO ₂ emissions ² in g/km, combined [7G-DCT]	130-126 [130-125]	135-129 [130-125]	122 [-]	135-130 [130-125]	119-117 [117-115]	- [156-151]	157-152 [143-141]	- [156-154]
Emission class ³ /efficiency class ⁴ [7G-DCT]	Euro 6/B [Euro 6/B]	Euro 6/B [Euro 6/B]	Euro 6/B [-]	Euro 6/B [Euro 6/B]	Euro 6/A [Euro 6/A]	- [Euro 6/C]	Euro 6/D [Euro 6/C]	- [Euro 6/C]
Tank capacity, of which reserve, approx. in l	50/6.0	50/6.0	50/6.0	50/6.0	20.0 kg/3.0 kg (natural gas) 12/5.0 (premium petrol)	56/6.0	50/6.0	56/6.0
Luggage compartment capacity ⁵ in l	488-1547	488-1547	488-1547	488-1547	501-1456	488-1547	488-1547	488-1547
Turning circle diameter in m	11.0	11.0	11.0	11.0	11.0	11.0	11.0	11.0
Kerb weight ⁶ in kg [7G-DCT]	1395 [1425]	1395 [1425]	1395 [-]	1395 [1425]	1505 [1535]	- [1505]	1440 [1465]	- [1505]
Perm. GVW in kg [7G-DCT]	1960 [1960]	1960 [1960]	1960 [-]	1960 [1960]	2020 [2050]	- [2030]	1990 [1990]	- [2030]

⁵ Figures according to Directive 70/156/EEC in the version 2000/40/EC. ⁶ Figures according to Directive 92/21/EC, version 95/48/EC (kerb weight with fuel tank 90% full, driver, 68 kg, and luggage, 7 kg) for standard-specification vehicles. Optional extras and accessories will generally increase this figure and reduce the payload capacity accordingly. ⁷ Figures apply solely for natural gas operation in kilograms per 100 km. Further technical data can be found at www.mercedes-benz.com

Dimensions.

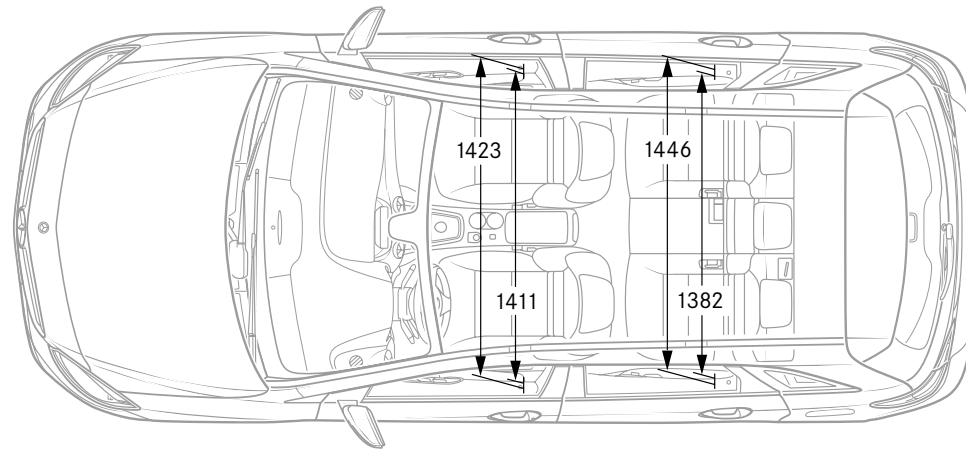
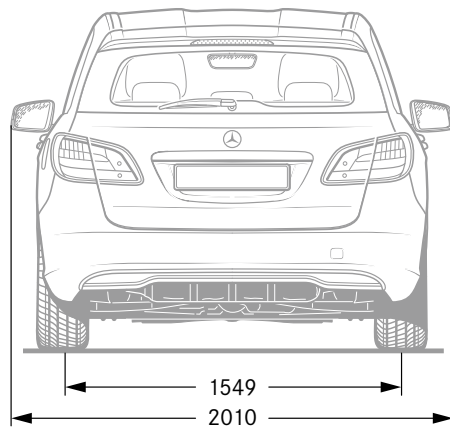
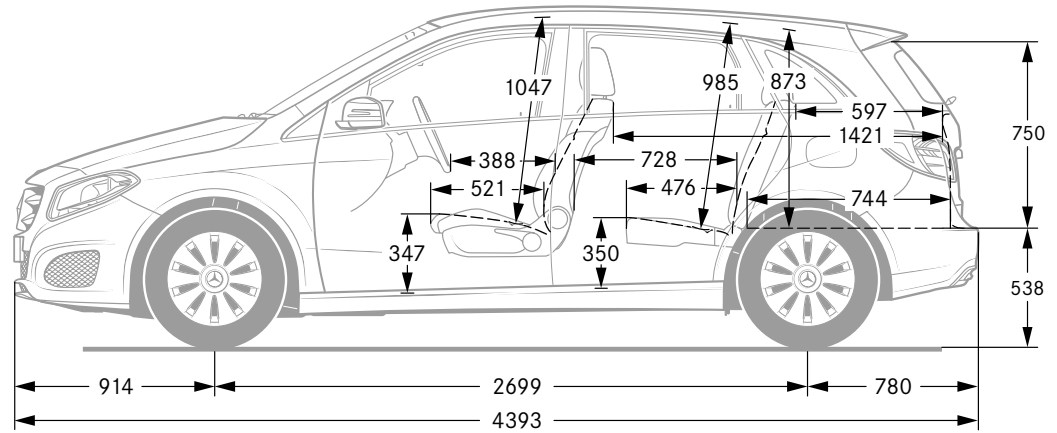
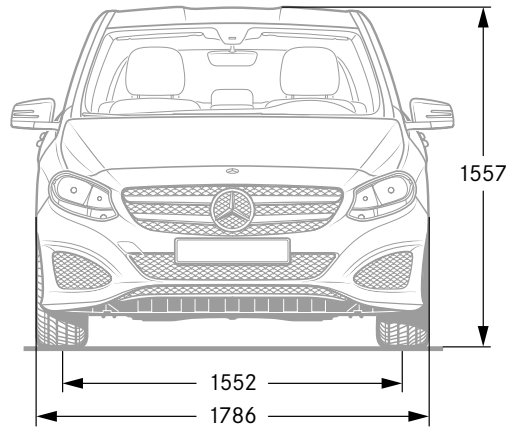

All dimensions in millimetres. The dimensions shown are mean values and apply to standard-specification, unladen vehicles. The dimensions shown correspond to vehicles with a diesel or petrol engine. Some figures may vary for the B 200 c.

Upholstery and trim.

Upholstery

- 001 Venlo fabric in black
- 031 Vianen fabric in black¹
- 038 Vianen fabric in crystal grey¹
- 105 ARTICO man-made leather in sahara beige²
- 111 ARTICO man-made leather in black²
- 118 ARTICO man-made leather in crystal grey²
- 201 Leather in black
- 204 Leather in hazelnut brown
- 207 Leather in cranberry red
- 611 ARTICO man-made leather/Montfoort fabric in black
- 618 ARTICO man-made leather/Montfoort fabric in crystal grey
- 661 ARTICO man-made leather/DINAMICA microfibre in black
- 821 RED CUT leather in black

Trim

- H88 Matrix look
 - H53 Line pattern
 - H81 Sail pattern
 - H74 carbon fibre look
 - 734 brown open-pore eucalyptus wood^{2,3}
 - 736 high-gloss black ash^{2,4}
-

Standard equipment

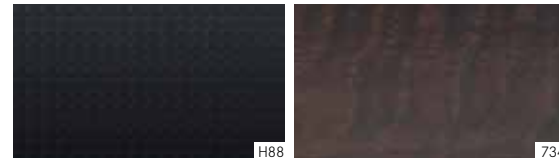
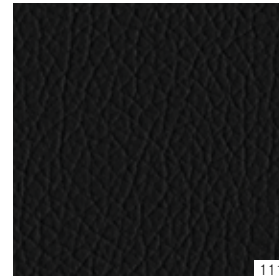
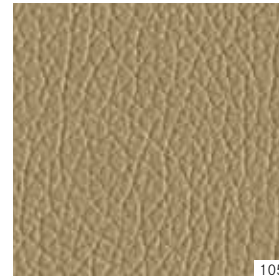
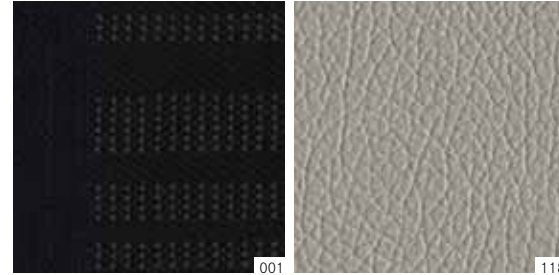

Style²

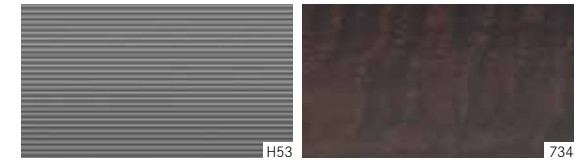
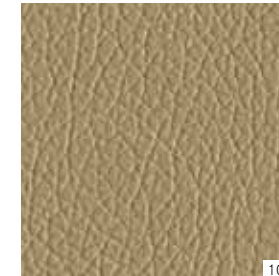
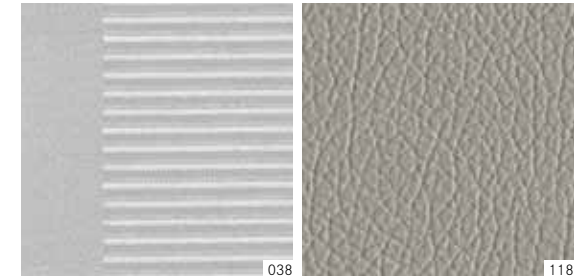
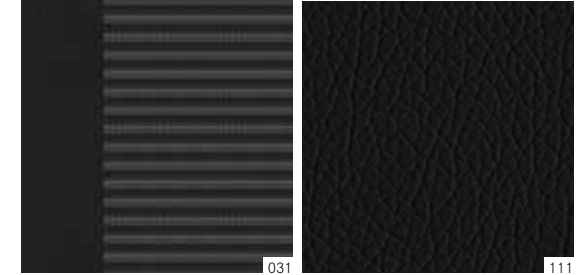

¹ Part of standard scope of equipment in conjunction with B 200 c. ² Optional extra.
³ Part of the Exclusive package. ⁴ Available as no-cost option with Exclusive package.

Urban²



611

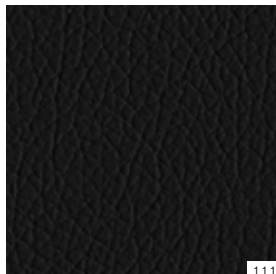

111

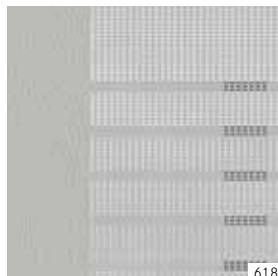

618

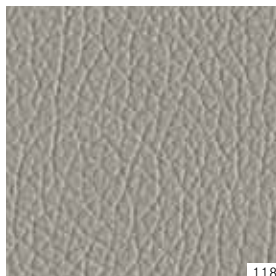

118

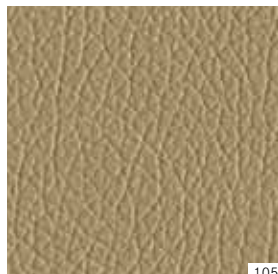

105

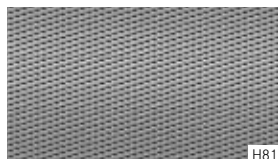

H81



734



736

AMG Line²



661



H74



736

Exclusive package²

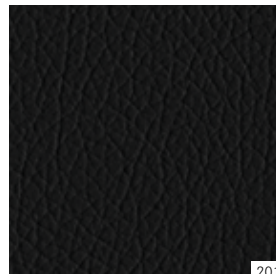

201

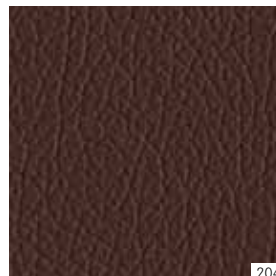

204



734



736

AMG Exclusive package²

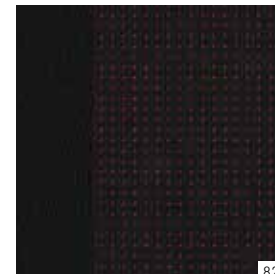

821

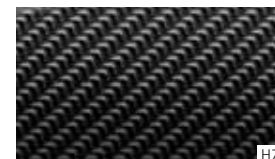

H74



736

Paintwork.

Non-metallic paints



589



650

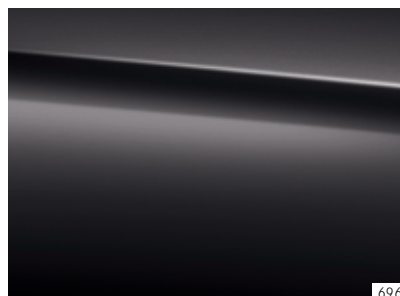

696

Metallic paints¹



162



175

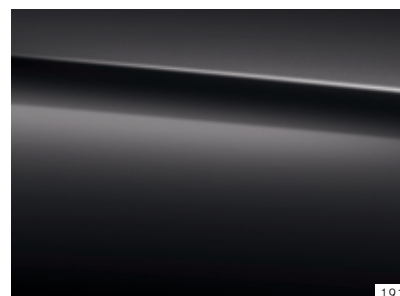

191

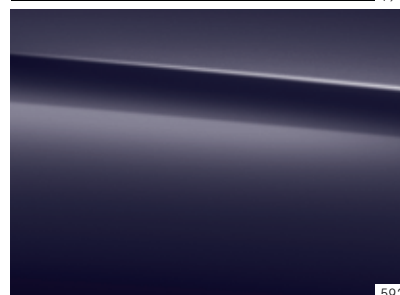

592

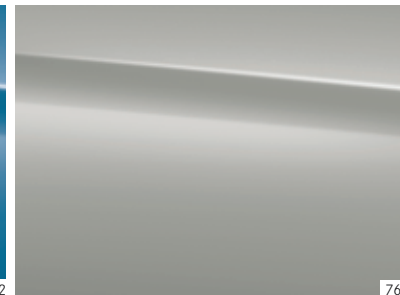

761

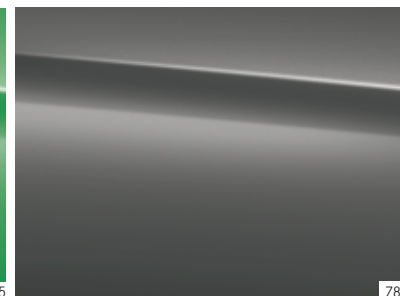

787

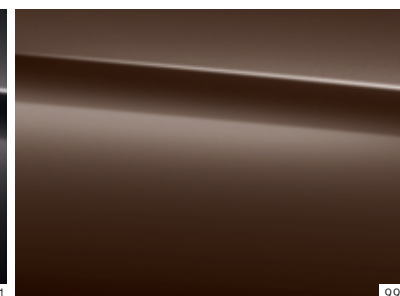

990

Non-metallic paints

- 589 jupiter red
650 cirrus white
696 night black
-

Metallic paints¹

- 162 south seas blue
175 elbaite green
191 cosmos black
592 northern lights violet
761 polar silver
787 mountain grey
990 orient brown
-

¹ Optional extras.



Mercedes-Benz is one of the founding partners of the “Laureus Sport for Good Foundation”.

Since the foundation was established in 2000, Mercedes-Benz has been supporting and promoting the aims and values of this worldwide non-profit-making programme: to improve the lives of children and young people who are disadvantaged or suffering from illnesses through social sports projects. Laureus has become a fundamental element of Mercedes-Benz's social responsibility. Every new Mercedes is an ambassador embodying these values. In buying a Mercedes you are supporting the “Laureus Sport for Good Foundation”.

Please note: changes may have been made to the product since going to press (29.04.2015). The manufacturer reserves the right during the delivery period to make changes to the design, form, colour or specification, provided these changes, while taking into account the interests of the vendor, can be deemed reasonable with respect to the purchaser. Where the vendor or the manufacturer uses symbols or numbers to describe an order or the subject of an order, no rights may be derived solely from these. The illustrations may include accessories and optional extras which do not form part of the standard specification. Actual colours may differ slightly from those shown, owing to the limitations of the printing process. This brochure is distributed internationally. Information given regarding statutory regulations, legal requirements and taxation and the consequences thereof applies to the Federal Republic of Germany only and is correct at the time of going to press. For current and more specific information in relation to the range of models, features, optional extras, colours and/or services available in your country, and their pricing, you should contact your nearest authorised Mercedes-Benz Passenger Car Dealer.

www.mercedes-benz.com

Take-back of end-of-life vehicles. At the end of its long life, you can return your B-Class to us for environment-friendly disposal in accordance with the European Union (EU) End-Of-Life Vehicle Directive. But that day lies a long way off.

A network of vehicle take-back depots and dismantlers has been established to make it as easy as possible for you to return your vehicle. You can leave it at any of these points free of charge. In so doing, you will be making a valuable contribution towards completing the recycling loop and preserving resources.

For further information about the recycling and disposal of end-of-life vehicles and take-back conditions, please visit your national Mercedes-Benz website.