

# LandCruiser 70

Still powerful, still indestructible.



**TOYOTA**



[toyota.com.au](http://toyota.com.au)



*Oh what a feeling!*

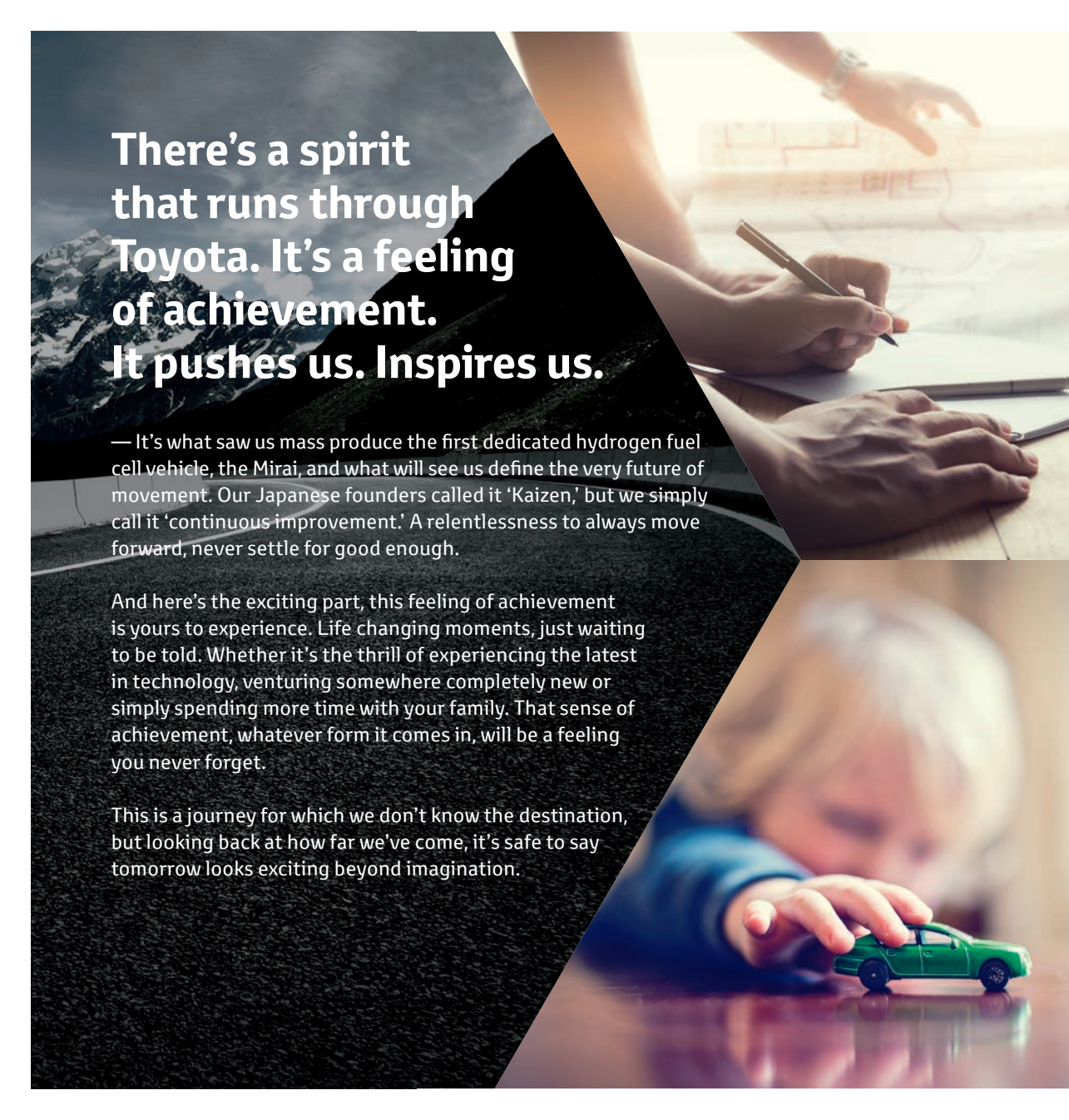

# There's a spirit that runs through Toyota. It's a feeling of achievement. It pushes us. Inspires us.

— It's what saw us mass produce the first dedicated hydrogen fuel cell vehicle, the Mirai, and what will see us define the very future of movement. Our Japanese founders called it 'Kaizen,' but we simply call it 'continuous improvement.' A relentlessness to always move forward, never settle for good enough.

And here's the exciting part, this feeling of achievement is yours to experience. Life changing moments, just waiting to be told. Whether it's the thrill of experiencing the latest in technology, venturing somewhere completely new or simply spending more time with your family. That sense of achievement, whatever form it comes in, will be a feeling you never forget.

This is a journey for which we don't know the destination, but looking back at how far we've come, it's safe to say tomorrow looks exciting beyond imagination.



“

*We are a group of passionate perfectionists who can't let well enough alone...*

*That's Toyota.*

*That's the spirit.*

*And that's our contribution to the world.  
We will be the best we can.*

*And we will help as many as  
we can to be the best they can...*

— Eiji Toyoda

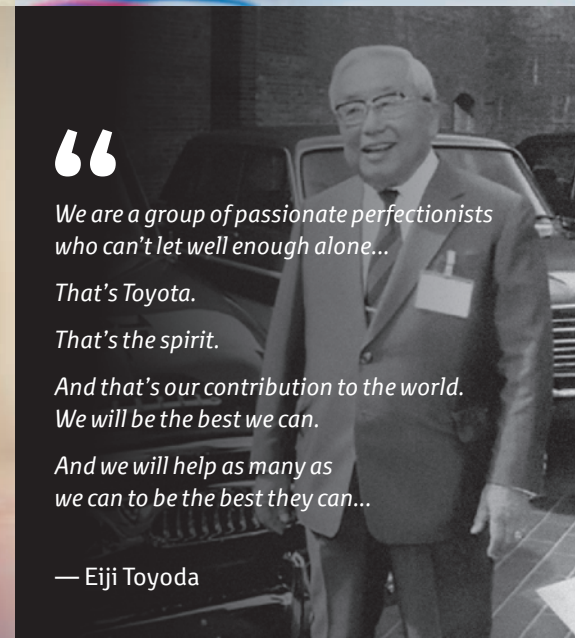

## Modern, purposeful with legendary strength.

The LandCruiser legend follows a path right back to 1957 and the Snowy Mountains Scheme. It was here the original LandCruiser forged its place in Australian folklore. Then through the years, as the work and demands got tougher, LandCruiser got stronger. From the Bass Strait pipeline projects to the roughest rural, mining and construction sites,

LandCruiser became the 'go to' vehicle you could always count on. Today, LandCruiser 70 Series are the uncompromising workhorses of the LandCruiser line-up. Delivering legendary strength combined with muscled-up looks, stacks of grunt and a truckload of impressive features and comforts inside.



Front cover: Single-Cab Cab-Chassis GXL model shown with optional Toyota Genuine tray body (Sold separately)

This page: Single-Cab Cab-Chassis GXL model shown with optional Toyota Genuine tray body, steel bullbar and side rails (Sold separately)

## A tough, work hardened physique.



The rugged good looks of the LandCruiser 70 Series are more than just skin deep. The tough steel body is built upon a full steel chassis to provide a strong stable platform.

Not only is the wide body design suitably muscular with real on-road presence, it also accommodates an awesome powerplant up front. And the A-pillar mounted snorkel helps your engine breathe better, particularly in dusty conditions.

That large, impressive looking front bumper is purposely designed to give a great approach angle, so you'll have heaps of clearance when lumbering over tough terrain.

And there's plenty of glass area to maximise visibility and come nightfall, powerful halogen lights show the way ahead.

## Shaping up to the challenge.

Regardless of the LandCruiser 70 you choose, you'll have a vehicle purpose built from the ground up to get stuck into the rough stuff.

The practical WorkMate in the Single-Cab and Double-Cab Cab-Chassis models, the Wagon and the Troop Carrier, is fitted with a black front bumper, radiator grille and mirrors.

Tough as nails 16" alloy wheels come as standard on

the GX and GXL Single-Cab, GXL Double-Cab Cab-Chassis and Wagon grades. All GXL models except the Troop Carrier feature over-fender flares and front wide mud guards as well as central

locking. A chrome grille, roof drip moulding and bumper are all standard on the GXL Single-Cab, Double-Cab Cab-Chassis, Wagon and the Troop Carrier models. These models, as well as WorkMate grades, also feature chrome door handles.



Troop Carrier GXL model shown



Single-Cab Cab-Chassis GXL model shown

## Comfort right up to the task

Whether you're doing a long haul behind the wheel or long hours on the tools, the interior features and comforts in LandCruiser 70 will help lighten the load.

The engine immobiliser is standard and helps ensure no-one drives your LandCruiser 70 without the nod from you. The lockable glove box also helps

keep your valuables in place.

There's an abundance of common sense with controls right where you need them and the blower and heater unit are integrated into one and placed centrally, for easy access.

The standard audio system incorporates an AM/FM tuner,

USB audio input for iPod<sup>®1</sup>/MP3<sup>2</sup> players and a MP3 compatible CD player with Bluetooth<sup>®3</sup> connectivity to keep the music working overtime.

In the GXL, you'll also have the luxury of power windows and remote central locking.

# Built to work your way

With a trusty beast that goes almost anywhere, does almost anything, you'll also appreciate the flexibility to load it the way you need. Across the LandCruiser 70 Series, you'll find versatile seating and cabin arrangements that are designed to handle the demands of many different jobs and situations.

In the Double-Cab Cab-Chassis and Wagon models, you'll have enough room to seat five adults and throw in their gear as well as the dog. And when you need to haul the whole crew up to the coalface, Troop Carriers can carry two or five people.

Plus the wide opening rear doors on the Wagon and Troop Carrier make it a breeze to load people and heavy gear.



Wagon GXL model shown

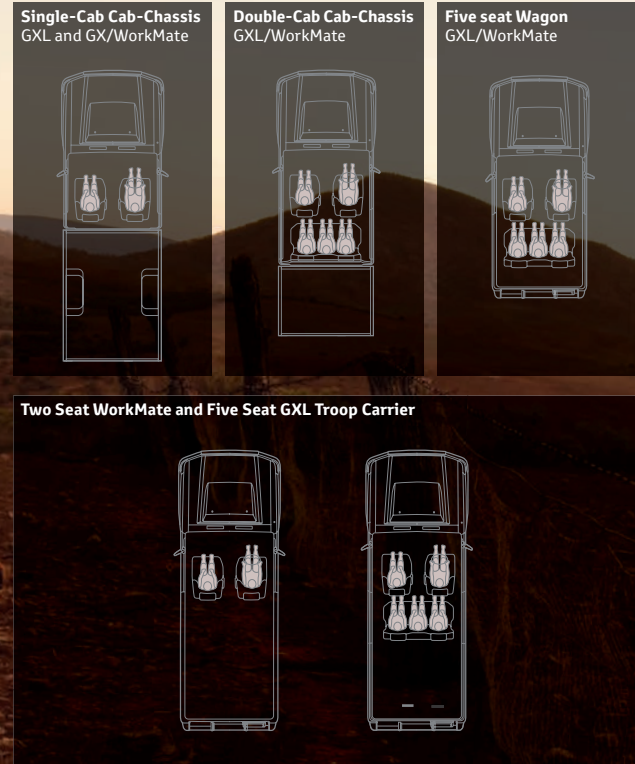

Images shown are for illustration purposes only. For full dimensions of the vehicle, please refer to [toyota.com.au/landcruiser-70](http://toyota.com.au/landcruiser-70) for spec table.



Troop Carrier WorkMate model shown





# Tough with a tender heart

LandCruiser 70 Series boasts all the grunt and muscle you need to get into uncharted territory. But it also packs in a heap of advanced features to help get you safely home again.

If called upon, the big, powerful ventilated disc brakes all round are ready to slow things down in a hurry. Plus an Anti-lock Braking System (ABS) is standard across the range.

The collapsible steering column has been designed to help provide protection in real life emergency situations, whilst the side intrusion beams help protect you from side-on collisions. These no nonsense measures are further enhanced by driver and front passenger SRS airbags, as well as Emergency Locking Retractor (ELR) seatbelts for the outer positions in the front cabin that also come standard across the range.

Not forgetting the little ones, Child Restraint System (CRS) upper tether anchors allow the easy fitting of child seats in the five door Wagons.

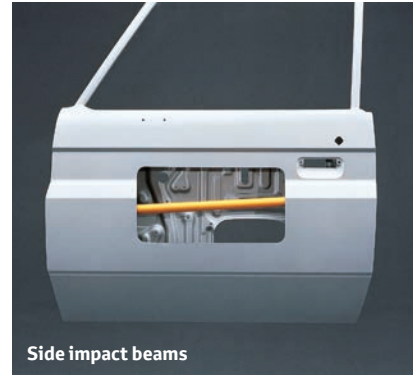

Side impact beams



Disc brakes

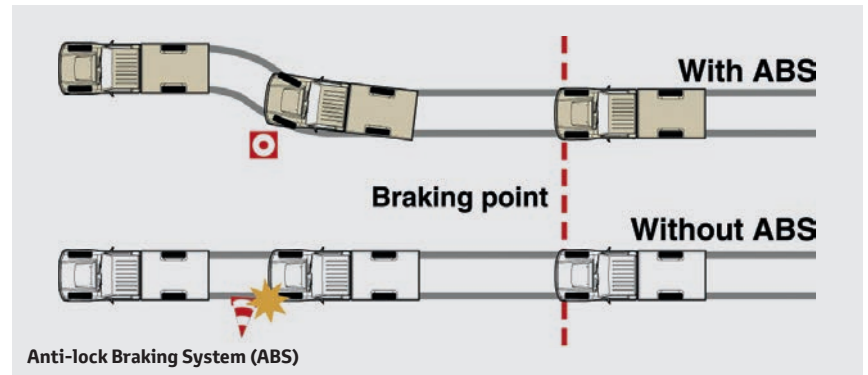

Anti-lock Braking System (ABS)

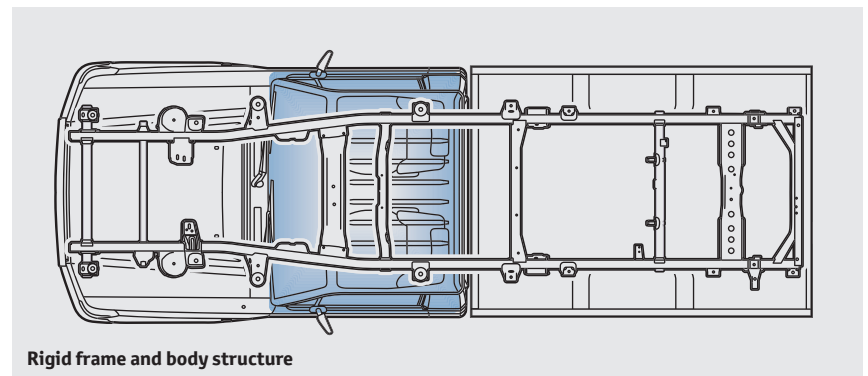

Rigid frame and body structure

# Real power. No sweat.

A real workhorse needs a big heart, and it'd be hard to find anything with more get-up and go than the LandCruiser 70 Series.

The 4.5 litre V8 Turbo diesel engine delivers enough grunt to help make tough jobs easy. With 151kW<sup>6</sup> of power coming on strong at just 3,400rpm<sup>6</sup>, and a massive 430Nm<sup>6</sup> of torque all the way from 1,200-3,200rpm<sup>6</sup>, you get quick acceleration, big pulling-power on steep hills and muscle to haul heavy loads.

The variable vane turbocharger also provides greater response at lower engine speeds and with the fuel efficiency of just 10.7 litres/100km<sup>7</sup> for the Single-Cab Cab-Chassis and Double-Cab Cab-Chassis, Troop Carrier and Wagon, you're sure to go a long way. Especially with a 180 litre fuel tank available on the Troop Carrier, and the 130 litre tank on all other models.

Plus there's the latest fuel injection and technology including Exhaust Gas Recirculation (EGR) to help LandCruiser 70 meet the Euro V emissions rules.

Then when it comes to harnessing such impressive power, the proven 5-speed manual transmission delivers smoothly across high and low range, even when faced with testing terrain and carrying some heavy loads.



WorkMate Double-Cab Cab-Chassis shown with optional Toyota Genuine tray (Sold separately)

# Single-Cab Cab-Chassis



## **WorkMate**

- 4.5 litre V8 Turbo diesel engine
- 130 litre fuel tank
- 5-speed manual transmission
- 16" steel wheels
- Steel side steps
- Black front bumper, radiator grille and exterior mirrors
- Tilt and telescopic steering column
- Engine immobiliser
- Cruise control
- Active Traction Control (ATRC)
- Anti-lock Braking System (ABS)
- 2 speaker single CD audio with manual antenna, Bluetooth,<sup>®3</sup> MP3 compatibility<sup>2</sup> and USB/AUX<sup>2</sup> inputs
- Vinyl floor covering
- Textured vinyl seats

Single-Cab Cab-Chassis GXL model shown with optional Toyota Genuine tray body (Sold separately)  
Tray fitted with under body tyre hanger (Sold separately)

## **GX – In addition to, or in replacement of, WorkMate features:**

- 16" alloy wheels
- Over-fender flares
- Front mudguards
- Multi-function clock
- Differential locks (optional)

## **GXL – In addition to, or in replacement of, GX features:**

- Aluminium side steps
- Power windows
- Central locking/remote keyless entry
- Variable intermittent wipers
- Differential locks
- Carpet flooring
- Cloth seats

# Double-Cab Cab-Chassis



## WorkMate

- 4.5 litre V8 turbo diesel engine
- 130 litre fuel tank
- 5-speed manual transmission
- 16" steel wheels
- Aluminium side steps
- Black front bumper, radiator grille and exterior mirrors
- Tilt and telescopic steering column
- Engine immobiliser
- Cruise control
- Active Traction Control (ATRC)
- Anti-lock Braking System (ABS)
- 2 speaker single CD audio with manual antenna, Bluetooth,<sup>®3</sup> MP3 compatibility<sup>2</sup> and USB/AUX<sup>2</sup> inputs
- Vinyl floor covering
- Textured vinyl seats

## GXL – In addition to, or in replacement of, WorkMate features:

- 16" alloy wheels
- Over-fender flares
- Chrome and painted front bumper
- Front mudguards (wide)
- Front fog lamps
- Multi-function clock
- Power windows
- Differential locks
- Central locking/remote keyless entry
- Variable intermittent wipers
- Carpet flooring
- Cloth seats

Double-Cab Cab-Chassis GXL shown with optional Toyota Genuine Tray Body (Sold separately)

# Wagon



## WorkMate

- 4.5 litre V8 Turbo diesel engine
- 130 litre fuel tank
- 5-speed manual transmission
- 16" steel wheels
- Aluminium side steps
- Black front and rear bumper, radiator grille and exterior mirrors
- Tilt and telescopic steering column
- Engine immobiliser
- Cruise control
- Active Traction Control (ATRC)
- Anti-lock Braking System (ABS)
- 4 speaker single CD audio with manual antenna, Bluetooth,<sup>3</sup> MP3 compatibility<sup>2</sup> and USB/AUX<sup>2</sup> inputs
- Vinyl floor covering
- Textured vinyl seats

## GXL – In addition to, or in replacement of, WorkMate features:

- 16" alloy wheels
- Over-fender flares
- Chrome and painted front and rear bumpers
- Front mudguards (wide)
- Front fog lamps
- Multi-function clock
- Power windows
- Central locking/remote keyless entry
- Variable intermittent wipers
- Differential locks
- Carpet flooring
- Cloth seats

Wagon GXL model shown

# Troop Carrier



## WorkMate

- 4.5 litre V8 Turbo diesel engine
- 180 litre fuel tank
- 5-speed manual transmission
- 16" steel wheels
- Steel side steps
- Front and rear mudguards
- Black front and rear bumper, radiator grille and exterior mirrors
- Tilt and telescopic steering column

- Engine immobiliser
- Cruise control
- Active Traction Control (ATRC)
- Anti-lock Braking System (ABS)
- 2 speaker single CD audio with manual antenna, Bluetooth,<sup>®3</sup> MP3 compatibility<sup>2</sup> and USB/AUX<sup>2</sup> inputs
- Vinyl floor covering
- Textured vinyl seats

## GXL – In addition to, or in replacement of, WorkMate features:

- Chrome and painted front and rear bumpers
- Front fog lamps
- Aluminium side steps
- Multi-function clock
- Front power windows
- Central locking/remote keyless entry
- Variable intermittent wipers
- Differential locks
- 4 speakers
- Carpet flooring (Rear vinyl)
- Cloth seats

Troop Carrier GXL model shown



Single-Cab Cab-Chassis GXL model shown with optional Toyota Genuine tray body and under body tyre hanger  
(Sold separately)





French Vanilla 058



Silver Pearl<sup>5</sup> 1F7



Graphite<sup>5</sup> 1G3



Merlot Red<sup>5</sup> 3Q3



Vintage Gold<sup>5</sup> 4R3



Sandy Taupe 4E9



Midnight Blue 8H6

## Land your perfect colour

From the red centre, to the bush or down by the sea, the colours of Australia are wonderfully vibrant and varied. And so are the seven knockout colours<sup>8</sup> for LandCruiser 70 Series, ready for you to blend in or stand out from your chosen terrain.

# Accessories for every situation

Whether you're loading the tray at work, or towing your camper on the weekend, you can be sure that Toyota Genuine Accessories<sup>9</sup> are designed to be the perfect fit for your LandCruiser 70.

Our development program ensures that the accessories are made to work with the vehicle as part of an integrated system, with many components developed years before vehicle launch. With an accessories range tested to perform in the toughest Australian conditions

and backed by our Toyota Warranty,<sup>10</sup> you can confidently kit up your vehicle to meet the demands of your lifestyle.

So, roll up your sleeves and make your LandCruiser 70 ready for anything with Toyota Genuine Accessories.

To find out more, go to: [www.toyota.com.au/landcruiser-70/accessories](http://www.toyota.com.au/landcruiser-70/accessories)



Single-Cab Cab-Chassis WorkMate model shown in French Vanilla accessorised with steel bullbar, heavy duty winch, side rails, bonnet protector, headlamp covers, front weathershields, tow bar, tow ball, trailer wiring harness and heavy duty steel tray. Accessories each sold separately.



Steel bullbar



Sunvisor (Unpainted)



Side rails (Steel bullbar sold separately)



Alloy bullbar



Winch (Lightweight synthetic rope winch shown)



Tow bar, tow ball and trailer wiring harness (Each sold separately)



**Alloy roof tray** (Roof racks sold separately)

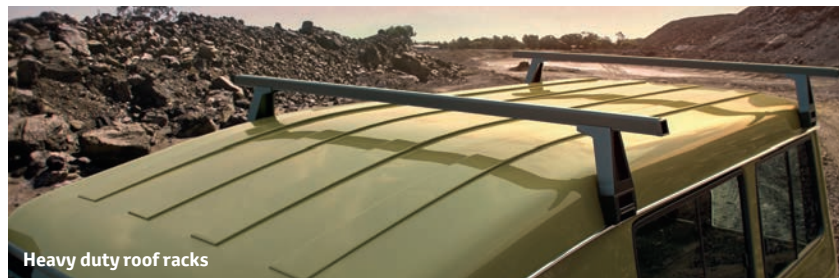

**Heavy duty roof racks**



**Canvas seat covers**



**Front weathershields** (Each sold separately)



**All weather floor mats**



**Load Distribution Hitch (LDH)**  
(Tow bar, tow ball and trailer wiring harness sold separately)



**Headlamp covers**



**Bonnet protector**



## The Toyota Advantage

Every Toyota gives you a lifetime of advantages. That's what makes it a Toyota. You'll enjoy legendary Toyota value from the moment you drive away, and you'll continue to appreciate the quality, safety and innovation that's engineered into each model, every day you drive.

Discover the full range of products and services and find your nearest Dealer at [toyota.com.au](http://toyota.com.au)

### Discover the freedom of Toyota Access.<sup>11</sup>

Toyota Access puts you in complete control when buying a new car, with lower monthly repayments.<sup>12</sup> Drive out of the Dealership with a clear road ahead then drive back a few years later with more options at your disposal than ever before. Whatever stage you're at in life, Toyota Access puts you in the driver's seat with flexibility and assurance. To discover Toyota Access for yourself visit [toyota.com.au/access](http://toyota.com.au/access)

### Capped price servicing.<sup>13</sup>

A new Toyota means you don't have to worry about unexpected service costs. Every Toyota comes with a low, capped price service cost for a set number of years/kilometres. Pay the same low capped price from one eligible logbook service to the next for up to three years or 60,000km, whichever occurs first (including Genuine parts, labour and fluids). For the full benefits consult a Toyota Dealer or visit [toyota.com.au/advantage](http://toyota.com.au/advantage)

### We've got your back

Every new Toyota is built to exceptional standards, backed by a three year/100,000km warranty,<sup>14</sup> giving you the peace of mind to feel confident for years to come. In the unlikely event that you need them, every Toyota Service Centre is committed to providing any warranty repairs you may need. They have the technology, the tools, and the skilled personnel to keep your Toyota in excellent condition.

### Finance to get you going.

If you need a little help, Toyota Finance<sup>15</sup> can offer you a wide range of vehicle financing options. With Toyota Finance, you'll have the peace of mind of dealing with one of Australia's leading vehicle finance corporations with over 30 years experience. And with a range of flexible products and services to suit almost every need and circumstance, Toyota Finance can help find the right package for you or your business.

### Insurance options

Our Comprehensive Motor Vehicle insurance policy is packed with great benefits including; agreed value cover, new vehicle replacement if your Toyota is written off within the first three years, use of Toyota Genuine Parts, and a Lifetime Repair Guarantee on repairs authorised by Toyota Insurance.<sup>16</sup> And our Factory Approved Extended Warranty Insurance also provides benefits, for more information visit [toyota.com.au/insurance](http://toyota.com.au/insurance)

### Extend your peace of mind

Whether it's a flat tyre, lost keys or a flat battery, Toyota Extra Care Roadside Assist<sup>17</sup> is never more than a phone call away. Available 24 hours a day, seven days a week, our technicians are there to help you get back on the road.

# Disclaimers and Notice

- 1 iPod® is a trademark of Apple, Inc. Not all devices will be compatible and functionality will vary depending on the device.
- 2 Not all devices will be compatible. Functionality varies depending on device.
- 3 The Bluetooth® word mark is owned by Bluetooth SIG, Inc. Not all devices will be compatible and functionality varies depending on the device.
- 4 Troop Carrier and Wagon GXL also come standard with vinyl rear flooring.
- 5 Paint featured is optional extra at additional cost.
- 6 Power and torque test standards differ. Ensure comparisons use same test standard.
- 7 Results achieved in test conditions. Actual results may vary depending on driving conditions/style, vehicle condition and options/accessories fitted. Fuel consumption data provided for comparison purposes only. Source: ADR81/02/combined.
- 8 Toyota Australia reserves the right to vary and discontinue the current interior and exterior colours, trims and colour/trim/model combinations. Colours and trims displayed here are a guide only and may vary from actual colours due to printing/display process. See your Toyota Dealer to confirm colour/trim/model availability when ordering your vehicle. Metallic/mica pearlescent paint is optional and subject to additional charges on most models.
- 9 Toyota Genuine Accessories are not applicable to all models/grades. Consider the mass of your load to ensure you will not exceed the maximum allowable individual axle capacity, Gross Vehicle Mass and/or Gross Combined Mass of the vehicle. Refer to the current Accessories brochure or visit [toyota.com.au](http://toyota.com.au) for details on warranty and [toyota.com.au/vehiclepayload](http://toyota.com.au/vehiclepayload) for details on vehicle payload, to help determine Accessories suitable for your vehicle. Accessory colours shown may vary from actual colour due to the printing process.
- 10 All Toyota Genuine Accessories purchased and fitted to a Toyota are warranted for the remainder of the New Vehicle Warranty, or 12 months whichever is greater. Toyota Genuine Accessories purchased from an authorised Toyota Dealer over the counter are warranted from the date of purchase for one year. The Toyota Genuine Accessories Warranty does not limit and may not necessarily exceed your rights under the *Competition and Consumer Act 2010*.
- 11 Terms and conditions, fees and charges apply. Toyota Access Guaranteed Future Value products are available to approved customers of Toyota Finance, a division of Toyota Finance Australia Limited ABN 48 002 435 181, AFSL and Australian Credit Licence 392536.
- 12 Lower monthly repayments compared to a similar term with no Guaranteed Future value (GFV) or equivalent balloon final payment. Total interest charges will be higher if a GFV or balloon final payment is selected.
- 13 Maximum payable for standard scheduled logbook servicing (normal operating conditions) until first of three years or 60,000km (whichever occurs first), up to the first six services. Excludes Government & Rental vehicles. Contact your Toyota Dealer or go to [toyota.com.au/advantage](http://toyota.com.au/advantage) for other exclusions, eligibility and full details.
- 14 New Vehicle Warranty expires three years from date of first delivery or 100,000km, whichever occurs first. Refer to the warranty conditions. The New Vehicle warranty does not limit and may not necessarily exceed your rights under the *Competition and Consumer Act 2010*.
- 15 Approved applicants only. Terms and conditions apply. Toyota Finance is a division of Toyota Finance Australia Limited ABN 48 002 435 181, AFSL and Australian Credit Licence 392536.
- 16 Terms and conditions apply. This advice is general in nature and does not take into account your objectives, financial situation or needs. Before making a decision to purchase any of the insurance products you should consider the appropriateness of the advice taking into account your own objectives, financial situation and needs and refer to the current PDS for the relevant product available from participating Dealers, via our website at [toyota.com.au/insurance](http://toyota.com.au/insurance) or by calling 137 200. Toyota Insurance purchased in a dealership or via the Toyota Insurance National Customer Solutions Centre is issued by Toyota Finance Australia Limited ABN 48 002 435 181, AFSL and Australian Credit Licence 392536. The insurer is Aioi Nissay Dowa Insurance Company Australia Pty Ltd ABN 11 132 524 282, AFSL 443540 (Adica). If Toyota Insurance is purchased online, the issuer and insurer is Adica. Our warranty insurance policies do not change or take away your rights under the Australian Consumer Law. Your right to claim under our warranty insurance policies for the benefits covered are in addition to other rights and remedies you have under the law in relation to your vehicle. However, you can choose to make a claim under any of our warranty insurance policies even if you have rights under the law.
- 17 Toyota Extra Care Roadside Assist is administered by Toyota Finance, a division of Toyota Finance Australia Limited ABN 48 002 435 181, AFSL and Australian Credit Licence 392536.

## IMPORTANT NOTICE – PLEASE READ:

Toyota Australia uses its best endeavours to ensure this material is correct when published. You must check with your authorised Toyota Dealer when ordering to ensure the vehicle with your chosen specifications, equipment and colour is available and that the vehicle can be delivered within the timeframe suitable to you. When ordering accessories, you must check with your authorised Toyota Dealer to ensure the accessory's design, features and colours are available and will fit your vehicle. Ensure the mass of your load does not exceed the maximum allowable individual axle capacity, Gross Vehicle Mass and/or Gross Combined Mass of the vehicle. Refer to [toyota.com.au/vehiclepayload](http://toyota.com.au/vehiclepayload) for further details. Colours displayed here are a guide only and may vary from actual colours due to printing/display processes. Certain accessories when fitted will require the removal of standard equipment. Standard equipment may be

retained by Toyota Australia. Toyota Australia reserves the right to change, without notice, at any time prices, colours, materials, equipment, specifications and discontinue colours/models. To the extent permitted by law, Toyota Australia will not be liable for any damage, loss or expense incurred as a result of reliance on this material in any way. Distributed nationally (other than in Western Australia) by Toyota Motor Corporation Australia Limited ABN 64 009 686 097, 155 Bertie St, Port Melbourne 3207. Material distributed in Western Australia by or on behalf of Prestige Motors Pty Ltd (for vehicles) and by Eastpoint Pty Ltd (for parts/accessories). Toyota Australia makes no warranties regarding (and will not be liable for) the accuracy of materials distributed in Western Australia. PART NUMBER: TYLC70PACKBRO. PROOF HQ: T2018-010086. GTO1974/GTO1973. VERSION: AUGUST 2018.