



THE 2007 NEXT-GENERATION E-CLASS



Mercedes-Benz



E350 4MATIC™ Sedan.



The next-generation E-Class.
Up close and personal.



E350 4MATIC™ Sedan.



E350 4MATIC™ Wagon shown with dealer accessory wheels.

The E-Class

INTRODUCTION	4	PERFORMANCE	
		Sport Packages	26
		AMG	28
SAFETY - PRO-SAFE™			
History of safety	6		
PERFORM-SAFE & PRE-SAFE®	8		
PASSIVE-SAFE & POST-SAFE	10		
4MATIC™	12	COLOURS AND MATERIALS	
		<i>designo</i>	30
		Combination options	32
		Paint, upholstery and trim	33
COMFORT		EQUIPMENT	
Interior comfort	14	Equipment listing	34
Ride comfort	18	Accessories	38
WAGON	20	TECHNICAL FEATURES	
		Technical data	40
DYNAMICS		SERVICE AND SUPPORT	
BLUETEC diesel	22	Customer care and website	41
Engines and transmissions	24		



E350 4MATIC™ Sedan shown with dealer accessory wheels.



Summing up Mercedes-Benz in one letter.

The next-generation E-Class epitomizes what makes a Mercedes-Benz.

For over 60 years, the letter E has been synonymous with comfort, safety and elegance. It is a tradition that the next-generation E-Class is proud to continue. The driving experience is as sublime as always and even more dynamic than ever thanks to our more powerful engines and improved steering and suspension. Essentially, we have made the E-Class even more of a joy to drive, while also preserving its legendary comfort.

On top of this, there are new design elements and colour variants, both inside and out. And for even more safety, we've added PRE-SAFE®, our revolutionary new proactive safety system.

We've been shaping the future of safety for the past 60 years.

It all started with a quiet revolution. Several decades ago, when Mercedes-Benz presented the first production car with passive safety features, the innovations on board, including a safety cell with crumple zones, were invisible to the casual observer.

Since then, Mercedes-Benz has proven itself a pioneer in the field of safety time and time again. In 1978, it was Mercedes-Benz that helped put anti-lock brakes on the map, and just three years later air bags and belt tensioners made their debut in a standard-production vehicle.

Throughout the years, Mercedes-Benz has doggedly pursued one goal: the vision of accident-free driving. It will be a while before this vision becomes a reality, but with our PRO-SAFE™ safety philosophy we have moved a step closer to fulfilling it.

Béla Barényi – seen here with a safety prototype – is the acknowledged father of passive safety engineering. His name appears on the Mercedes-Benz patents for the safety passenger cell with crumple zones and the safety steering column.





Be ready for the unexpected.

PERFORM-SAFE is made up of active safety features like the “control and display” concept, which minimizes distractions from what is happening on the road. It also includes systems that provide support in critical situations and alert the driver to potential hazards – such as our Electronic Stability Program (ESP®), Brake Assist (BAS) and the ADAPTIVE BRAKE system, which includes a brake-drying function for wet weather.

Truly visionary thinking, the optional Active Bi-Xenon headlamps¹ monitor your steering angle and driving speed, then swivel their beams to either side to better follow the curvature of the road ahead. They give you a better view into corners by increasing usable illumination by up to 90% over conventional headlamps, so you can now detect obstacles earlier than was previously possible.

PRE-SAFE® measures hazards and takes precautionary measures to reduce the risk of injury to occupants. This includes reversible belt tensioners and automatic closure of the side windows and sunroof in critical situations.



¹Optional on the E320 BLUETEC Sedan.



PASSIVE-SAFE

In 1959 we developed the world's first passenger safety cell. Today we are still building one of the sturdiest passenger cells around: the E-Class.



PERFORM-SAFE

Our Electronic Stability Program (ESP®) can dramatically enhance cornering control by monitoring your steering and braking actions and responding nearly instantaneously if it detects oversteer or understeer.

PRE-SAFE®

Some hazards can appear without warning. Luckily there are safety systems that are even faster. Like the reversible belt tensioners.

POST-SAFE

The E-Class continues to provide protection even after an accident occurs. This includes automatic fuel cut-off and other features that help to speed and facilitate occupant rescue.

Some safety features you'll hopefully never notice.

PASSIVE-SAFE and POST-SAFE: protection in the event of an accident.

The E-Class contains a wide range of safety systems designed to prevent accidents. Should an accident be unavoidable, **PASSIVE-SAFE** features are quick to react. **PASSIVE-SAFE** offers protection for your own vehicle and for others, including a high-strength safety cell, adaptive front air bags, side-impact air bags, head protection curtains, and the crash responsive **NECK-PRO** head restraints for the driver and front passenger seats. In the event of a rear-end impact, pre-tensioned springs push the head restraints on the driver and front passenger seats forward, bracing the heads of the front seat occupants and reducing the risk of whiplash.

POST-SAFE includes measures that help to prevent the situation from deteriorating after an accident. The fuel tank, for example, is situated in the protected area in front of the rear axle. Furthermore, the engine and fuel supply are automatically switched off after a serious collision. To prevent secondary

accidents and make it easier to locate the vehicle concerned, the hazard warning lights are activated automatically. The doors also unlock automatically so that occupants can be rescued more quickly after an accident.



The **NECK-PRO** head restraints are sensor-controlled.

The E-Class makes the best of bad weather.

4MATIC™ permanent all-wheel-drive – dependable traction in rain and snow.

Our award-winning 4MATIC™ permanent all-wheel drive provides optimal traction, whatever the road conditions. It splits the engine power between the front and the rear wheels for 100% road holding. For maximum active safety and handling control, 4MATIC™ works in tandem with the Electronic Stability Program (ESP®) and the Electronic Traction System (4-ETS). If one or more wheels lose grip, 4-ETS applies precisely controlled amounts of braking pressure to help maintain control.





E350 4MATIC™ Wagon.



E350 4MATIC™ Sedan shown with dealer accessory wheels.

Comfort made the E-Class what it is today.

Or should that be the other way around?

When it comes to making you feel at ease, the E-Class has few rivals which is not about to change – but we have tweaked a few of the details to help enhance the feeling. For example, front seat occupants can now select their preferred temperature using the very latest climate systems. You and your front passenger will also sit in luxury seats equipped with heating, ventilation control and luxury head restraints if you opt for our Climate Comfort front seats.

An atmosphere of total comfort is standard in the E-Class – thanks in no small part to the THERMATIC automatic climate control system, which allows front seat occupants to select temperature levels to suit their own individual requirements.

The E550 4MATIC™ and E63 AMG's THERMOTRONIC luxury automatic climate control system allows separate temperature control in four different zones. A four-quadrant solar sensor takes into account the angle of the sun's rays at each of the four seats when controlling both the air volume and air temperature. Humidity and pollutants in the ambient air are monitored by a sensor and, if necessary, THERMOTRONIC automatically switches to recirculation mode.

Mercedes-Benz is the only carmaker in the world that investigates the medical and psychological aspects of driving. This has led to the development of assistance systems that make driving safer and more enjoyable.

Such systems include DISTRONIC¹ proximity control and LINGUATRONIC² voice control, both of which make for relaxed, stress-free driving.



¹Optional on E550 4MATIC™ and E63 AMG Sedans. ²Optional on all models.

Comfort can take you anywhere.

Even the longest journey is more relaxing if you're sitting in the E-Class. ARTICO leather¹ is standard on the E320 BLUETEC, and premium leather is standard on the E350 4MATIC™ Sedan and Wagon, as well as the E550 4MATIC™ Sedan. The Nappa leather upholstery featured on the E63 AMG is particularly sumptuous.

Standard 10-way power adjustment for the heated front seats, and manually adjustable lumbar support for the driver's seat allow the ideal seat position to be found. Optional Climate Comfort

seats are available for the driver and front passenger, featuring three-stage heating, active ventilation to cool the seat surfaces and individually adjustable luxury head restraints.

All E-Class models come standard with the COMAND control and display system. It combines a radio and MP3-compatible CD player. All functions are controlled on a large colour display. State-of-the-art TFT screen technology results in excellent brilliance and colour rendering.

All 4MATIC™ and AMG models come standard with the harman/kardon® LOGIC7® Surround Sound System Package, featuring twelve loudspeakers, 420-watts of power, a 9-channel DSP amplifier and a 6-disc CD changer. This system, which is specially matched to the interior acoustics of the vehicle, allows all occupants to enjoy amazingly realistic and breathtakingly precise sound quality, wherever they happen to be sitting. This package is available as an option on the E320 BLUETEC Sedan.



¹Man-made leather.

The full power adjustment for the front seats can be operated by means of controls in the doors. The Memory Package allows you to store three settings for the driver and front passenger seats, the steering column and the exterior mirrors.

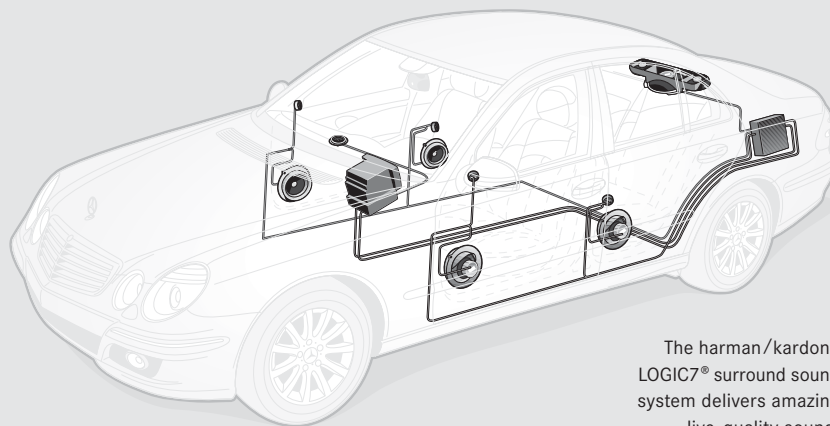

The harman/kardon® LOGIC7® surround sound system delivers amazing live-quality sound.





E550 4MATIC™ Sedan shown with optional PARKTRONIC.

You could go a long way to find peace and quiet. But you don't have to.

You'll barely hear the engines. And barely feel the road.

Fine wood and sumptuous materials aren't the only factors that help create the exceptional comfort you'll experience in the E-Class. The silence of the E-Class is legendary. Credit for the low noise levels inside the car goes in part to the measures taken to isolate engine sound. This and further extensive sound-absorbing measures mean that, while you'll hear a lot about the E-Class, you won't hear a lot from it.

The E-Class transmissions equal its engines in terms of comfort and dynamics. With the 7G-TRONIC 7-speed automatic transmission, standard on the E320 BLUETEC and with AMG

SPEEDSHIFT enhancements on the E63 AMG, gear changes are barely perceptible. It constantly operates in the optimum engine speed range for a sublime driving experience at all times. All 4MATIC™ models feature a refined 5-speed automatic transmission.

Further to its almost imperceptible engines and transmissions, the E-Class' enhanced DIRECT CONTROL packages give you more driving enjoyment, particularly through corners, with no loss of ride comfort. Direct steering and reduced pitch and roll help to create a more agile driving experience.

All this can be taken to an even higher level with AIRMATIC DC air suspension on the E550 4MATIC™ and E63 AMG Sedans. AIRMATIC DC uses the Adaptive Damping System (ADS) to automatically reduce body roll when cornering. If the sensors detect sporty driving, the comfortable default suspension setting is automatically firmed up. AIRMATIC DC is self-leveling and maintains a constant ride height for greater stability and improved handling. At high speeds, the body is automatically lowered to reduce roll and pitch.

Instead of conventional coil springs, the semi-active air suspension features air springs that are automatically adjusted according to the driver's style.



The E-Class – think big.

The Wagon: ideal packaging for your luggage.

A load capacity of up to 1,950 litres doesn't really need further explanation. But size alone has never been enough for the E350 4MATIC™ Wagon, which is why it features intelligent storage solutions.

To make sure that everything stays where you want it to stay, the EASY-PACK load-securing kit is available as part of the Premium Package. It includes cargo rails, a telescopic bar and a retractable belt, all designed to secure a variety of objects in place.



EASY-PACK
load-securing kit





E350 4MATIC™ Wagon.





More power, less fuel.

The BLUETEC diesel engine.

The V6-engine in the E320 BLUETEC Sedan produces 210 hp and 388 lb-ft of torque, so you can be sure that economical driving is highly enjoyable.

The uncanny smoothness of this engine can be attributed to the Lanchester balancer shaft and extensive damping. Extra smoothness is added by the standard 7G-TRONIC automatic transmission.

A newly engineered catalytic converter and a series of specialized filters help to minimize emissions. With the added fuel economy of the diesel engine, it helps ensure that the environmental impact of the E320 BLUETEC is minimized.

Performance art at its finest.

We go to extraordinary lengths to produce the special driving experience offered by the E-Class. An extensive technology package is the secret behind the V-6 engine in the E350 4MATIC™ models. All camshafts feature variable adjustments across the entire engine speed range. Optimum fuel combustion also results in low consumption, while a unique balancer shaft ensures smooth operation.

Performance goes a step further on the E550 4MATIC™ with its V-8 engine. The key data: 5.5-litre displacement, 382 hp and maximum torque of 391 lb-ft. The result: a sublime driving experience, whatever the situation. Thanks to a lower final drive ratio, we were able to lower the engine speed level – and with it, the noise level.

The top-of-the-line E-Class engine is the new high-performance AMG powerplant in the E63 AMG. It provides 507 hp and 465 lb-ft of torque and rockets the vehicle to 100 km/h in just 4.5 seconds¹.

¹ Stated rate of acceleration is based upon manufacturer's track results and may vary depending upon model, environmental and road surface conditions, driving style, elevation and vehicle load.

The E63 AMG's maximum torque of 465 lb-ft is available across a broad engine speed range from 2,800 rpm to 4,800 rpm.

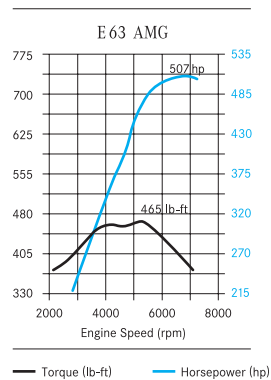



The difference others see and you can feel.

The Sport Package and AMG Sport Package.

Why not nurture the E-Class' sporting talents with the optional Sport Package for the E350 4MATIC™ Sedan? It includes 18" aluminium-alloy wheels, moulded side skirts and front and rear bumper trim. On the technical side, the Sport Package makes its mark with a lower slung chassis and a powerful-sounding dual pipe exhaust system with oval stainless steel tailpipes. The larger brake system with painted calipers and perforated front brake discs are eye-catching

and provide extra braking power. The Sport Package extends its punchy feel to the interior too. The sport seats provide perfect support at speed and are upholstered in premium leather.

The AMG Sport Package, optional for the E550 4MATIC™ Sedan, includes AMG body styling, including dynamic front and rear aprons and chromed AMG tailpipes. Another exclusive feature is the 18" 5-spoke AMG aluminium-alloy wheels.



The Sport Package includes studded brushed stainless steel pedals and floor mats with silver chain-stitching.

The AMG Sport Package includes 18" aluminium-alloy wheels and a dynamic front apron.

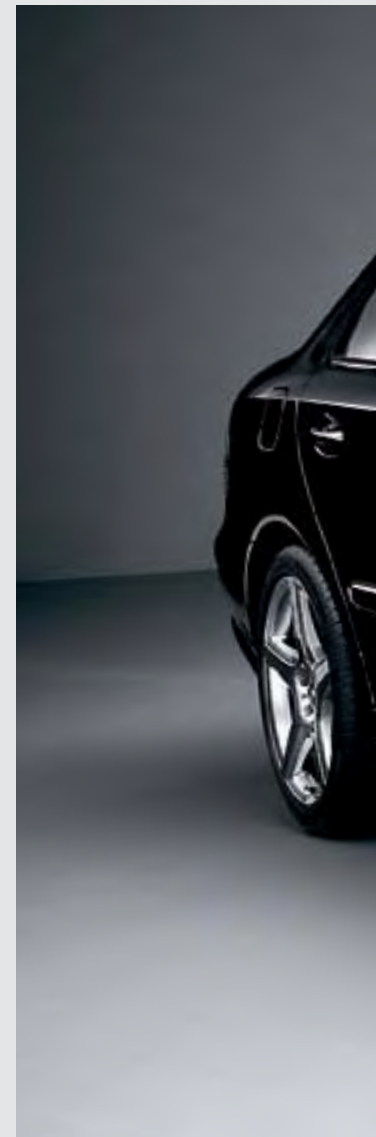



E550 4MATIC™ Sedan shown with optional AMG Sport Package.



E63 AMG Sedan shown with optional Premium Package.

A sport car among sport cars.

The E63 AMG with its new 507 hp, 6.3-litre V-8 engine.

The most powerful E-Class comes courtesy of the Mercedes-Benz AMG motorsport experts. The new E63 AMG has 507 hp and accelerates from 0 to 100 km/h in just 4.5 seconds¹ And maximum torque of 465 lb-ft ensures that acceleration from any other speed is an equally breathtaking experience. The top speed is electronically governed at 250 km/h, but there are no limits to the driving pleasure on offer. That's partly due to the AMG SPEEDSHIFT 7G-TRONIC transmission. The three shift programs give you a choice between a Comfort or Sport mode, as well as a manual mode that lets you change gears using AMG shift paddles on the ergonomic sport steering wheel. The set-up has distinct echoes of the world of motor racing – as does the AMG high-performance braking system with its composite front brake discs, and the AMG sport suspension.

In visual terms, the new E63 AMG cuts a striking figure: The AMG body styling consists of a front apron, side air outlets, circular chrome-ringed foglamps, a rear apron and side skirts. A slick AMG spoiler enhances the trunk lid. Other exclusive features of the E63 AMG include an AMG sport exhaust with two chromed twin tailpipes and 18" AMG 5-spoke light-alloy wheels, painted titanium grey and burnished.

In the exclusive interior of the E63 AMG, high quality Nappa leather appointments await, with AMG sport seats featuring Alcantara inserts at shoulder level. There's an ergonomic AMG sport steering wheel to help you keep the E63 AMG under firm control, and the selector lever is trimmed in fine leather and Alcantara. These various features, including the RACETIMER in the AMG instrument cluster – assure an exciting motor racing atmosphere.

The E63 AMG: It's not often you can savour engine performance like this in such a comfortable interior.

¹ Stated rate of acceleration is based upon manufacturer's track results and may vary depending upon model, environmental and road surface conditions, driving style, elevation and vehicle load.



designo.



An E-Class that matches your style to perfection.

designo – for those with exceptional taste.

designo offers a true feast for the senses. Once your eyes have taken in the many metallic paint finishes and the leather combinations, you'll savour the scent of the fine leather and the touch of the silk matte sealed wood surfaces. But it's not just the quality and workmanship that make *designo* so unique: It's also the almost infinite range of combinations. They allow you to give your Mercedes-Benz a signature of its own – as if you were furnishing your home.

The seats and door centre panels can be trimmed in single-tone or two-tone leather in a choice of nine shades. The six-rib upholstery fluting, with elaborately stitched double lap seams, is exclusive to *designo*. *designo* leather upholstery also includes a black roof liner and a gearshift lever in black *designo* leather.

For the wood trim, you have a choice of *designo* Umber Maple Grain, *designo* Brown Poplar or *designo* Red-Brown Cinnamora.

Have we whetted your appetite? See your dealer for further details.

NON-METALLIC PAINTS

METALLIC PAINTS

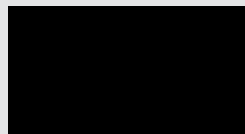

040 Black

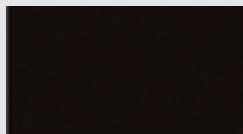

197 Obsidian Black



544 Barolo Red

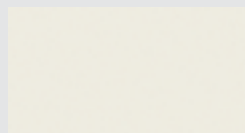

650 Calcite White



300 Periclase Green

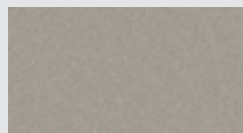

723 Pewter Silver



353 Platinum Blue

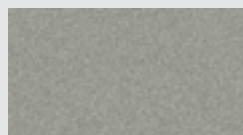

747 Granite Grey



359 Capri Blue

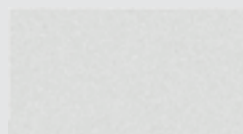

775 Iridium Silver

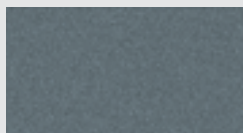

368 Flint Grey

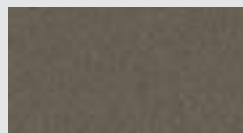

963 Iridium Grey

	ARTICO LEATHER			LEATHER			NAPPA LEATHER				
	Black	Cashmere Beige	Alpaca Grey	Black	Cashmere Beige	Alpaca Grey	Black/Sahara Beige	Black/Cognac Brown	Black	Cashmere Beige	Alpaca Grey
NON-METALLIC PAINTS											
Black	●	●	●	●	●	●	●	●	●	●	●
Calcite White	●	○	●	●	○	●	-	●	●	○	●
METALLIC PAINTS											
Obsidian Black	●	●	●	●	●	●	●	●	●	●	●
Periclase Green	●	●	○	●	●	○	○	-	●	●	○
Platinum Blue	●	-	○	●	-	○	○	-	●	-	○
Capri Blue	●	○	●	●	○	●	●	○	●	○	●
Flint Grey	●	-	●	●	-	●	○	○	●	-	●
Barolo Red	●	○	●	●	○	●	●	-	●	○	●
Pewter Silver	●	-	○	●	-	○	○	●	●	-	○
Granite Grey	●	-	○	●	-	○	●	-	●	-	○
Iridium Silver	●	-	○	●	-	○	-	●	●	-	○
Iridium Grey	●	●	-	●	●	-	●	○	●	●	-

● Recommended ○ Possible - Not recommended

Both non-metallic and metallic paint finishes benefit from the extra scratch-resistant clearcoat, which makes them less susceptible to environmental factors such as precipitation, sunlight, temperature variations, dust and soot.

ARTICO LEATHER¹



141 Black

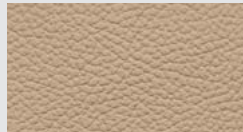

144 Cashmere Beige

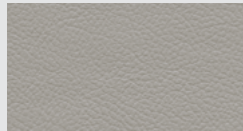

148 Alpaca Grey

LEATHER²



821 Black

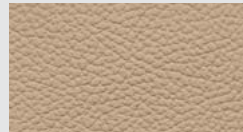

824 Cashmere Beige

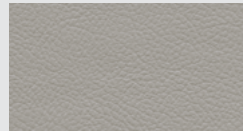

828 Alpaca Grey



825 Black/Sahara Beige³

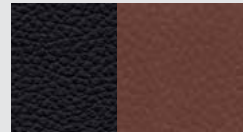

827 Black/Cognac Brown³

NAPPA LEATHER⁴



851 Black

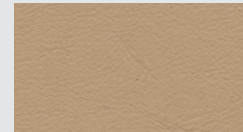

854 Cashmere Beige

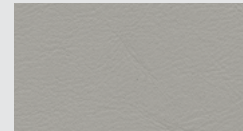

858 Alpaca Grey

WOOD



Burl Walnut⁵



Black Bird's Eye Maple⁶

¹Man-made leather, standard on the E320 BLUETEC Sedan. ²Standard on the E350 4MATIC™ and E550 4MATIC™ models, optional for the E320 BLUETEC Sedan.

³Optional with the Sport Package on E350 4MATIC™ and E550 4MATIC™ sedans (package not available for E350 4MATIC™ Wagon). Seats and door panels in selected colour (single tone leather), other interior appointments in contrasting black. ⁴Standard on the E63 AMG Sedan, not available on other models. ⁵Standard on the E320 BLUETEC and E350 4MATIC™ Sedan and Wagon. ⁶Standard on the E550 4MATIC™ and E63 AMG Sedans. Also included in the optional Sport Package for the E350 4MATIC™ Sedan.

<i>INDIVIDUAL EQUIPMENT (SELECTION)</i>	E320 BLUETEC	E350 4MATIC™	E350 4MATIC™ Wagon	E550 4MATIC™	E63 AMG
TRANSMISSION					
5-speed automatic transmission	-	●	●	●	-
7G-TRONIC 7-speed automatic transmission	●	-	-	-	●
TRACTION/STABILITY					
ADAPTIVE BRAKE	●	●	●	●	●
AIRMATIC DC suspension	-	-	-	●	●
Anti-lock braking system (ABS)	●	●	●	●	●
Brake Assist (BAS)	●	●	●	●	●
Electronic Stability Program (ESP®)	●	●	●	●	●
Speed-sensitive power steering	●	●	●	●	●
AUDIO/COMMUNICATION					
Cellular telephone preparation (MHI)	○ ¹	○	○	○	●
COMAND APS with navigation	○	○	○	○	●
harman/kardon® LOGIC7® surround sound system with 6-disc CD changer	○	●	●	●	●
LINGUATRONIC voice control	○ ²	○ ²	○ ²	○ ²	○
EXTERIOR					
16" twin-spoke aluminium-alloy wheels	●	-	-	-	-
17" aluminium-alloy wheels	-	●	●	-	-
18" aluminium-alloy wheels	-	○ ³	-	●	●
Active Bi-Xenon headlamps with washers and cornering lights	○	●	●	●	●
Auto-dimming mirrors (rearview and driver's side)	●	●	●	●	●
DISTRONIC	-	-	-	○	○

● Standard ○ Optional - Not available

<i>INDIVIDUAL EQUIPMENT (SELECTION)</i>	E320 BLUETEC	E350 4MATIC™	E350 4MATIC™ Wagon	E550 4MATIC™	E63 AMG
Electronically adjustable heated exterior mirrors with turn signal indicators	●	●	●	●	●
Panoramic sunroof ⁴	○	○	-	○	○
Power-tilt/sliding glass sunroof	●	●	●	●	●
Rain-sensing windshield wipers with heated windshield washing system	●	●	●	●	●
Remote trunk release	●	●	●	●	●
Tinted glass	●	●	●	●	●
INTERIOR					
10-way power adjustable, heated front seats with 3-position memory	●	●	●	●	●
ARTICO leather upholstery ⁵	●	-	-	-	-
Climate Comfort front seats	-	○	○	○	○
Cruise control	●	●	●	●	●
Electronic trunk closer	○	○	-	○	○ ³
Heated rear seats	○ ⁶	○ ⁴	○ ⁴	○ ⁴	○ ⁴
Heated steering wheel	●	●	●	●	-
High gloss wood trim	●	●	●	●	●
Integrated garage door opener	●	●	●	●	●
Interior Lighting Package	●	●	●	●	●
ISOFIX child seat mounts	●	●	●	●	●
KEYLESS-GO	○	○	○	○	○ ³
Leather/Burl Walnut steering wheel	○	○	○	○	-
Leather steering wheel	●	●	●	●	●
Leather upholstery	○	●	●	●	-

INDIVIDUAL EQUIPMENT (SELECTION)

	E320 BLUETEC	E350 4MATIC™	E350 4MATIC™ Wagon	E550 4MATIC™	E63 AMG
Nappa leather upholstery	-	-	-	-	●
PARKTRONIC	○	○	-	○	○
Power-tilt/telescoping steering column	●	●	●	●	●
THERMATIC automatic climate control	●	●	●	-	-
THERMOTRONIC 4-zone automatic climate control	-	-	-	●	●
SAFETY					
Anti-theft alarm system with tow-away protection	●	●	●	●	●
Belt tensioners with two-stage belt-force limiters for driver and front passenger, one-stage for outer rear seats	●	●	●	●	●
Dual-front, side and window air bags	●	●	●	●	●
First aid kit	●	●	●	●	●
Five 3-point seat belts; front height-adjustable, rear with automatic belt-height adjustment (except centre rear)	●	●	●	●	●
PRE-SAFE®	●	●	●	●	●
TeleAid Emergency Calling System ⁷	●	●	●	●	●
Tire pressure loss warning system	●	●	●	●	●
Tire pressure monitoring system	○	○	○	○	○

● Standard ○ Optional - Not available



E350 4MATIC™ shown with optional Sport Package.

¹Only available with harman/kardon® Sound System Package. ²Only available with cellular telephone preparation. ³Only available as part of an Optional Package. ⁴Only available in conjunction with an Optional Package. ⁵Man-made leather. ⁶Only available in conjunction with leather upholstery. ⁷Subscription is required for service to be active. TeleAid operates only where cellular and Global Positioning System coverage is available.

PREMIUM PACKAGES

	E320 BLUETEC	E350 4MATIC™	E350 4MATIC™ Wagon	E550 4MATIC™	E63 AMG
E320 BLUETEC Sedan: COMAND APS with navigation. Split-folding rear seats. Trunk pass-through with ski sack. Rear window sunshade.	○	-	-	-	-
E350 4MATIC™ & E550 4MATIC™ Sedans: COMAND APS with navigation. PARKTRONIC. Split-folding rear seats. Trunk pass-through with ski sack. Rear window sunshade.	-	○	-	○	-
E350 4MATIC™ Wagon: COMAND APS with navigation. EASY-PACK load securing kit. Trunk pass-through with ski sack. Rear window sunshade. Door-integrated roller blinds for rear side windows.	-	-	○	-	-
E63 AMG Sedan: KEYLESS-GO. PARKTRONIC. Electronic trunk closer. Door-integrated roller blinds for rear side windows.	-	-	-	-	○

● Standard ○ Optional - Not available

OPTION PACKAGES

	E320 BLUETEC	E350 4MATIC™	E350 4MATIC™ Wagon	E550 4MATIC™	E63 AMG
Bi-Xenon Headlamps Package: Active Bi-Xenon headlamps with washers and cornering lights.	○	●	●	●	●
harman/kardon® Sound System Package: harman/kardon® LOGIC7® surround sound system with 6-disc CD changer.	○	●	●	●	●
Sport Package: 18" 10-twin spoke aluminium-alloy wheels. Upgraded brake calipers. Body kit. Stainless steel dual exhaust tailpipes. Sport suspension. Sport gearshift.	-	○	-	●	-
AMG Sport Package: Sport suspension. AMG Styling Package (front apron, rear bumper and side sills). AMG 18" 5-spoke light-alloy wheels. Performance tires.	-	-	-	○	-

Optional panoramic sunroof.



Optional COMAND APS with DVD-based navigation.



Optional KEYLESS-GO.

Finish with a finishing touch or two.

If you want to give your E-Class an even sportier look, you'll find exactly what you're looking for with our complete line of accessories. We've introduced a long list of new accessories and features for this model year. Here is an in-depth look at just a few.

See your dealer for more information.



Roof rack

The Alustyle ski and snowboard rack is incredibly practical. It holds up to 4 pairs of skis or 2 snowboards.



iPod® Integration Kit

You've spent time carefully filling your iPod® with the great music you love. Now you can enjoy every minute of every song as you cruise in your E-Class, courtesy of the iPod® Integration Kit.



17" "Markab" multi-spoke Incenio light-alloy wheels

These designer accessory wheels make a statement. With a 245/45 R 17 specification, these multi-piece wheels add an extra flare that will get you noticed.



18" "Almach" 5-twin spoke light-alloy wheels

18" "Almach" 5-twin spoke light-alloy wheels Opt for the timeless 5-twin spoke design with the "Almach" accessory wheels for your new E-Class. Emphasize power and performance with the 245/45 R 18 all-season tires.



E350 4MATIC™ Sedan shown with optional Sport Package.

	<i>E320 BLUETEC</i>	<i>E350 4MATIC™</i>	<i>E350 4MATIC™ Wagon</i>	<i>E550 4MATIC™</i>	<i>E63 AMG</i>
Engine type	DOHC 24-valve V-6	DOHC 24-valve 90° V-6	DOHC 24-valve 90° V-6	DOHC 32-valve 90° V-8	Naturally aspirated DOHC 32-valve 90° V-8
Total displacement	2,987-cc	3,498-cc	3,498-cc	5,461-cc	6,208-cc
Net power	210 hp @ 3,800 rpm	268 hp @ 6,000 rpm	268 hp @ 6,000 rpm	382 hp @ 6,000 rpm	507 hp @ 6,800 rpm
Net torque	388 lb-ft @ 1,600-2,700 rpm	258 lb-ft @ 2,400-5,000 rpm	258 lb-ft @ 2,400-5,000 rpm	391 lb-ft @ 2,800-4,800 rpm	465 lb-ft @ 5,200 rpm
Compression ratio	17.7:1	10.7:1	10.7:1	10.7:1	11.3:1
Acceleration, 0-100 km/h ¹	6.8 seconds	7.1 seconds	7.4 seconds	5.5 seconds	4.5 seconds
Approximate top speed ²	250 km/h	250 km/h	245 km/h	250 km/h	250 km/h
Tires, front rear	225/55 R 16 225/55 R 16	245/45 R 17 245/45 R 17	245/45 R 17 245/45 R 17	245/40 R 18 245/45 R 18	245/40 R 18 265/35 R 18
Fuel economy, ³ combined city/highway estimate	Information N/A	12.9-8.8 L/100 km	13.2-9.2 L/100 km	15.6-9.6 L/100 km	17.2-10.8 L/100 km
Fuel tank capacity	80.0 litres (9.0-litre reserve)	80.0 litres (9.0-litre reserve)	80.0 litres (9.0-litre reserve)	80.0 litres (9.0-litre reserve)	80.0 litres (14.0-litre reserve)
Fuel requirement	Diesel	Premium unleaded gasoline	Premium unleaded gasoline	Premium unleaded gasoline	Super premium unleaded gasoline
Dimensions: ⁴ Wheelbase	112.4 in/2,854 mm	112.4 in/2,854 mm	112.4 in/2,854 mm	112.4 in/2,854 mm	112.4 in/2,854 mm
Overall length	191.2 in/4,856 mm	191.2 in/4,856 mm	192.4 in/4,888 mm	191.2 in/4,856 mm	191.2 in/4,856 mm
Overall height	58.4 in/1,483 mm	58.4 in/1,483 mm	59.3 in/1,506 mm	58.4 in/1,483 mm	58.4 in/1,483 mm
Overall width	81.2 in/2,063 mm	81.2 in/2,063 mm	81.2 in/2,063 mm	81.2 in/2,063 mm	81.2 in/2,063 mm
Track, front rear	62.1 in/1,577 mm 61.8 in/1,570 mm	62.1 in/1,577 mm 61.8 in/1,570 mm	61.4 in/1,559 mm 61.1 in/1,552 mm	62.1 in/1,577 mm 61.8 in/1,570 mm	62.1 in/1,577 mm 61.8 in/1,570 mm
Coefficient of drag	0.27	0.27	0.32	0.27	0.27
Curb weight	3,858 lb/1,750 kg	3,935 lb/1,785 kg	4,231 lb/1,920 kg	4,144 lb/1,880 kg	4,057 lb/1,840 kg
Trunk capacity	14.4 cu ft/407.8 litres	14.4 cu ft/407.8 litres	40.7 cu ft/1,152.5 litres	14.4 cu ft/407.8 litres	14.4 cu ft/407.8 litres

¹Stated rates of acceleration are based upon manufacturer's track results and may vary depending upon model, environmental and road surface conditions, driving style, elevation and vehicle load.

²Electronically limited. ³These estimates are based on the Government of Canada's approved criteria and testing methods. The actual fuel consumption of this vehicle may vary. Refer to the *Fuel Consumption Guide*. ⁴Dimensions shown are for models with standard equipment.

Mercedes-Benz Customer Care

24-hour Roadside Assistance

During the basic warranty coverage of 48 months and the time duration of the optional Extended Limited Warranty, Mercedes-Benz Roadside Assistance will be at your service. We'll bring you some gas, replace a flat tire with your spare, or jumpstart your car. In the event of a mechanical breakdown, if attempts by our Roadside Assistance technician have not made your vehicle safely operable, towing service will be provided to the nearest Mercedes-Benz dealership. Assistance is available 24 hours a day, every day, to anyone driving a Mercedes-Benz anywhere in Canada or the continental U.S.¹

Wear and tear coverage

For 24 months or 40,000 km (whichever comes first) many items normally considered "wear and tear," such as light bulbs, brake pads and discs, are covered. If necessary, an authorized Mercedes-Benz dealer will replace these parts at no charge to you.

Customer service

Owning a Mercedes-Benz means that when you have a question, we're here to help. Customer Service is open from 9 a.m. to 5 p.m. EST, Monday through Friday, and is staffed with knowledgeable Mercedes-Benz people who can talk you through the finer points of working your car's audio system – or even assist you in locating the nearest Mercedes-Benz dealership. Just call 1-800-387-0100. It's that simple.

Mercedes-Benz warranties

The Mercedes-Benz New Car Limited Warranty covers defects in materials or workmanship for 48 months or 80,000 km, whichever occurs first. To widen your window of confidence, you can opt for a Mercedes-Benz Extended Limited Warranty as well.²

Trip interruption reimbursement

If a breakdown covered by your New Car Limited Warranty occurs more than 80 km from your home, leaves your Mercedes-Benz vehicle inoperable or unsafe to drive, and requires overnight repairs, we've got you covered. You will be reimbursed up to \$500 for hotel accommodations and up to \$600 for alternate travel expenses per incident while your car is being repaired at an authorized Mercedes-Benz dealership.

Log on to learn more

mercedes-benz.ca

Looking for more Mercedes-Benz information? Visit mercedes-benz.ca to open an online window to Mercedes-Benz Canada. Get information about any model, including financing and leasing options, upcoming vehicles, or purchase Mercedes-Benz the Collection gifts and personal accessories. Our website also offers details about the Mercedes-Benz Extended Limited Warranty, Customer Care, and the history of Mercedes-Benz.



¹ Vehicle must be accessible from main roads. Roadside Assistance may involve charges for parts, service and towing. Depending on the circumstances, these services may be provided by an outside service provider, courtesy of Mercedes-Benz Roadside Assistance. For full details of the Roadside Assistance Program, please see your dealer. ² Please see your dealer for warranty details as well as for terms, conditions and pricing for extended warranty options.

© 2006 Mercedes-Benz Canada Inc. Marketing Communications.

All illustrations and specifications contained in this brochure are based on the latest product information available at the time of publication.

Mercedes-Benz reserves the right to make changes at any time, without notice, in colours, materials, equipment, specifications and models.

Any variations in colours shown are due to reproduction variations of the printing process. Illustrations may include test situations.

Some vehicles may be shown with non-Canadian equipment. Some vehicles are shown with optional equipment.

harman/kardon and LOGIC7 are registered trademarks of Harman International Industries Inc. iPod is a registered trademark of Apple Computer, Inc.

Printed in Canada

MBC-06-E07-20

Mercedes-Benz Canada Inc. 98 Vanderhoof Avenue. Toronto, Ontario M4G 4C9

1-800-387-0100

www.mercedes-benz.ca

E350 4MATIC™ Sedan with optional PARKTRONIC shown on cover.