

HUMMER EV PICKUP

2024 FEATURES, SPECS AND OPTIONS



Preproduction models shown throughout. Actual production models may vary.

HUMMER EV is available from a GMC EV dealer.

We have tried to make this guide comprehensive and factual. We reserve the right, however, to make changes at any time, without notice, in prices, colors, materials, equipment, specifications, models and availability. Specifications, dimensions, measurements, ratings and other numbers in this guide and other printed materials provided at the dealership or affixed to vehicles are approximations based on design and engineering drawings, prototypes and laboratory tests. Your vehicle may differ due to variations in manufacture and equipment. Since some information may have been updated since the time of publication, please check with your GMC dealer for complete details.

GMC
WE ARE PROFESSIONAL GRADE

TABLE OF CONTENTS

03. **MODEL OVERVIEW HIGHLIGHTS**

HUMMER EV 2^x
HUMMER EV 3^x

04-12. **KEY FEATURES**

Exterior
Interior
Capability
Safety and technology

13. **MODEL PACKAGES**

Select packages available

14. **MODEL SPECS**

HUMMER EV 2^x
HUMMER EV 3^x

15. **TRAILERING OVERVIEW**

Key trailering features
Key specifications
Powertrains

16. **PAYLOAD AND TRAILERING SPECS**

Ultium Drive Systems—e4WD
Electric drive specifications

17-24. **TRAILERING TECHNOLOGY**

ProGrade™ Trailering System
myGMC Mobile App
In-vehicle Trailering App
Smart trailer integration
Camera-view compatibility
Calibration tips
Trailering tech availability

25. **HITCH STYLES**

Conventional trailer hitch
Weight-carrying hitch
Weight-distributing hitch

26. **ACCESSORIES**

Key available accessories



HUMMER EV 2^x PICKUP KEY FEATURES

- | Ultium Drive System Performance e4WD with 2 motors
- | Super Cruise¹ hands-free driver-assistance technology; includes 3-year subscription²
- | CrabWalk^{TM3} diagonal-drive functionality at low speeds
- | Ultium Battery 20-module pack
- | ProGrade Trailering System
- | Fast charging-capable with compatible DC fast charger (up to 300 kW)⁴
- | MultiProTM Tailgate
- | eTrunkTM lit compartment with 4 cargo tie-downs



HUMMER EV 3^x PICKUP KEY FEATURES

- | Ultium Drive System Performance Torque Vectoring e4WD with 3 motors
- | Infinity Roof with removable modular opaque Sky Panels
- | Air Ride Adaptive Suspension with adjustable ride height and Extract Mode³
- | Bose⁵ premium 14-speaker audio system
- | Super Cruise¹ hands-free driver-assistance technology; includes 3-year subscription²
- | Watts to Freedom⁶ launch experience
- | Available fast charging-capable with compatible DC fast charger (up to 350 kW)⁴
- | Available Ultium Battery 24-module pack
- | Available Extreme Off-Road Package

AVAILABLE COLORS



INTERSTELLAR
WHITE



NEPTUNE BLUE
MATTE^{7,8}



VOID
BLACK⁹



TIDE
METALLIC¹⁰



DEEP AURORA
METALLIC¹⁰



AFTERBURNER
TINTCOAT¹⁰



METEORITE
METALLIC⁹



SUPERNOVA
METALLIC¹⁰

¹Always pay attention while driving and when using Super Cruise. Do not use a handheld device. Requires active Super Cruise plan or trial. Terms apply. Visit gmc.com/connectivity-technology/super-cruise for compatible roads and full details. ²After initial 3-year period, an eligible OnStar[®] Super Cruise plan must be purchased. Plans vary by vehicle and model and require active service plan, working electrical system, cell reception and GPS signal. Does not include safety services. Super Cruise vehicles are connected to emergency services. See onstar.com for details and limitations.

³Limited to low speeds. Read the vehicle Owner's Manual for important feature limitations and information. ⁴Requires use of compatible public DC fast chargers. ⁵Bose is a registered trademark of the Bose Corporation in the U.S. and other countries. ⁶Watts to Freedom is intended for use only on a closed course and should not be used on public roads. Read the vehicle Owner's Manual for important feature limitations and information. ⁷Special care required for matte paint. Read the vehicle Owner's Manual for more details. ⁸Included and only available with Omega Edition. ⁹Extra-cost color. ¹⁰Extra-cost color. Late availability.

YOUR HUMMER EV PICKUP AWAITS

KEY FEATURES

See your GMC dealer or gmc.com for more feature details and requirements.

EXTERIOR

Wheels, 22" gloss-black painted aluminum with LT305/55R22 (35") all-terrain tires

Wheels, 22" premium-finish painted aluminum with selective machining and LT305/70R18 (35") all-terrain tires

Wheels, 18" black aluminum with machined accents and LT305/70R18 (35") Goodyear® Wrangler Territory MT tires (requires Extreme Off-Road Package)

LED headlamps with LED daytime running lamps

LED front signature lighting; includes HUMMER EV light bar, walk-up and departure animation, charge status and turn signals

LED signature taillamps with LED stop and reverse lights

Rear charge port lighting with charge status

LED front crystal-like amber roof marker lamps

LED rear crystal-like red roof marker lamps

LED bed area lighting

Mirrors, outside heated power-adjustable, power-folding and driver-side auto-dimming with puddle lamps, side perimeter lighting and memory

5' pickup bed with spray-on bedliner

MultiPro™ Tailgate (power release)

120V (400W) power outlet, rear bed

2^x

3^x



● Standard ○ Available — Not Available

CONTINUED

YOUR HUMMER EV PICKUP AWAITS

KEY FEATURES

See your GMC dealer or gmc.com for more feature details and requirements.

2^x

3^x

EXTERIOR CONTINUED

Aluminum fixed assist steps

●

●

Rocker protectors with assist steps (requires Extreme Off-Road Package)

○

○

Front steel skid protector/shielding

●

●

Front intermittent 3-blade wipers with Rainsense

●

●

Power hood, eTrunk lit compartment with Infinity Roof Sky Panel storage, 12V DC power outlet and emergency hood release button

●

●

Recovery hooks,¹ two front, articulating D-ring, frame-mounted, black

●

●

Recovery hooks,¹ two rear, articulating D-ring, frame-mounted, black (requires Extreme Off-Road Package)

○

○

Full underbody skid plates (including front differential, battery and rear differential) (requires Extreme Off-Road Package)

○

○

● Standard ○ Available — Not Available



Shown with available dealer-installed accessories.



¹To avoid the risk of injury, never use recovery hooks to tow a vehicle. For more information, see the Recovery Hooks section of the vehicle Owner's Manual.

YOUR HUMMER EV PICKUP AWAITS

KEY FEATURES

See your GMC dealer or [gmc.com](https://www.gmc.com) for more feature details and requirements.

INTERIOR

	2 ^x	3 ^x
Premium leather-alternative perforated front bucket seats	●	●
12-way power front seats including 4-way lumbar	●	●
Heated/ventilated front seats	●	●
Heated second-row outboard seat cushions	●	●
60/40 split fold-up second-row seats	●	●
Driver memory settings (seat, outside mirrors and steering wheel)	●	●
Automatic heated steering wheel	●	●
Keyless open and start	●	●
Remote vehicle starter system with preconditioning	●	●
Rear Camera Mirror, ¹ inside rearview auto-dimming with full camera display	●	●
Tri-zone automatic climate control	●	●
Power Rear Drop Glass	●	●

● Standard ○ Available — Not Available

CONTINUED

YOUR HUMMER EV PICKUP AWAITS

KEY FEATURES

See your GMC dealer or gmc.com for more feature details and requirements.

2^x3^x

INTERIOR CONTINUED

Infinity Roof with modular Sky Panels (opaque, with 4 eTrunk storage bags and removable I-bar)



Infinity Roof with modular Sky Panels (transparent, with 4 eTrunk storage bags and removable I-bar; included with Omega Edition)



Full, removable rubber floor with premium carpet inserts (over vinyl flooring) (requires Omega Edition)



Full, removable rubber floor with rubber inserts (over vinyl flooring)



Wireless Apple CarPlay^{®1} compatibility



Wireless Android Auto^{™2} compatibility



Wireless phone charging³



Bose⁴ 14-speaker audio system with Centerpoint[®] and electric vehicle sound enhancement



Instrument cluster and Driver Information Center, reconfigurable, 12.3" diagonal



Wi-Fi[®] Hotspot⁵



Universal Home Remote



12V DC power outlet located in storage console under the center armrest



4 USB ports⁶ (2 front power/data, 2 rear power)



Two 120V AC power outlets (400W shared power, located in the rear of the center console and rear of cargo bed)



● Standard ○ Available — Not Available

¹Vehicle user interface is a product of Apple[®] and its terms and privacy statements apply. Requires compatible iPhone[®] and data plan rates apply. Apple CarPlay is a trademark of Apple, Inc. Siri, iPhone and iTunes are trademarks of Apple, Inc., registered in the U.S. and other countries. ²Vehicle user interface is a product of Google, and its terms and privacy statements apply. Wireless use of Android Auto requires a compatible Android 11.0+ phone and compatible active data plan. Check g.co/androidauto/requirements for compatibility. Android and Android Auto are trademarks of Google LLC. ³The system wirelessly charges one compatible mobile device. Some phones have built-in wireless charging technology and others require a special adapter/back cover. To check for phone or other device compatibility, see gmc.com/support/vehicle/phone-connect or consult your carrier. ⁴Bose is a registered trademark of the Bose Corporation in the U.S. and other countries. ⁵Service varies with conditions and location. Requires active service plan and paid AT&T[®] data plan. See onstar.com for details and limitations. ⁶Not compatible with all devices.

YOUR HUMMER EV PICKUP AWAITS

KEY FEATURES

See your GMC dealer or gmc.com for more feature details and requirements.

CAPABILITY

2-motor e4WD (electric 4-wheel drive) single-motor front and rear electric drive units

3-motor Performance Torque Vectoring e4WD single-motor front and dual-motor rear electric drive units

EPA-estimated 311-mile range¹ Ultium Battery 20-module pack, 570 hp² and 7,400 lb-ft of torque² (with standard 22" wheels and tires)

EPA-estimated 279-mile range¹ Ultium Battery 20-module pack, 625 hp² and 7,400 lb-ft of torque² (with Extreme Off-Road Package)

EPA-estimated 314-mile range¹ Ultium Battery 20-module pack, 830 hp² and 11,500 lb-ft of torque² (with standard 22" wheels and tires)

EPA-estimated 298-mile range¹ Ultium Battery 20-module pack, 830 hp² and 11,500 lb-ft of torque² (with Extreme Off-Road Package)

GM-estimated 359-mile range³ Ultium Battery 24-module pack, 1,000 hp² and 11,500 lb-ft of torque² (with Extreme Off-Road Package)

GM-estimated 381-mile range³ Ultium Battery 24-module pack, 1,000 hp² and 11,500 lb-ft of torque² (with standard 22" wheels)

Watts to Freedom,⁴ 0-60 mph in approximately 3.5 seconds⁵ (included when Extreme Off-Road Package is ordered on EV 2^x)

Watts to Freedom,⁴ 0-60 mph in approximately 3.0 seconds⁵ (requires Ultium Battery 24-module pack)

19.2 kW/80A onboard AC charging module

2^x3^x

—

—



—



—

—



—



—



—



—



● Standard ○ Available — Not Available

CONTINUED

¹On a full charge. Actual range may vary based on several factors, including ambient temperature, terrain, battery age and condition, loading, and how you use and maintain your vehicle. ²GM-estimated. ³On a full charge based on development testing and/or analytical projection consistent with SAE J1634 revision 2017-MCT. Range subject to change prior to production. Actual range may vary based on several factors, including ambient temperature, terrain, battery age and condition, loading, and how you use and maintain your vehicle. ⁴Watts to Freedom is intended for use only on a closed course and should not be used on public roads. Read the vehicle Owner's Manual for important feature limitations and information. ⁵GM-estimated. On a closed course only. Based on initial vehicle movement.

YOUR HUMMER EV PICKUP AWAITS

KEY FEATURES

See your GMC dealer or [gmc.com](https://www.gmc.com) for more feature details and requirements.

2^x3^x

CAPABILITY CONTINUED

Fast charging-capable with a compatible DC fast charger (up to 300 kW)¹



Fast charging-capable with a compatible DC fast charger (up to 350 kW)¹ (included and only available with Ultium Battery 24-module pack)



Ultium Battery 20-module pack



Ultium Battery 24-module pack



Dual-level charge cord—dual-mode, portable, 120V (1.4 kW) and 240V (7.7 kW) capability



Drive Mode Control (My Mode, Normal, Off-Road, Terrain and Tow/Haul modes)



Air Ride Adaptive Suspension with adjustable ride height and Extract Mode²



4-wheel steer, electronic with CrabWalk² diagonal-drive functionality at low speeds



Electronic Precision Shift with low selection for throttle-off regenerative braking and One-Pedal Driving capability³



Regen on Demand⁴ steering-wheel paddle



Electronic Parking Brake



Independent front and rear suspension



● Standard ○ Available — Not Available

CONTINUED

¹Requires use of compatible public DC fast chargers. ²Limited to low speeds. Read the vehicle Owner's Manual for important feature limitations and information. ³Feature may be limited when the battery temperatures are extremely cold or hot or when battery is near full charge. Always use the brake pedal when you need to stop immediately. See the vehicle Owner's Manual for details. ⁴Feature may be limited when the battery temperatures are extremely cold or hot or when battery is near full charge. See the vehicle Owner's Manual for details.

YOUR HUMMER EV PICKUP AWAITS

KEY FEATURES

See your GMC dealer or gmc.com for more feature details and requirements.

2^x

3^x

CAPABILITY CONTINUED

Front- and rear-sliding caliper disc brakes with Duralife rotors



StabiliTrak, electronic stability control system with traction control



Tire inflator kit



Trailer hitch, 7-pin connector and Hitch Guidance¹



Trailer brake controller, integrated



ProGrade Trailering System



● Standard ○ Available — Not Available



¹Safety or driver-assistance features are no substitute for the driver's responsibility to operate the vehicle in a safe manner. Read the vehicle Owner's Manual for important feature limitations and information.

YOUR HUMMER EV PICKUP AWAITS

KEY FEATURES

See your GMC dealer or gmc.com for more feature details and requirements.

2^x

3^x

SAFETY AND TECHNOLOGY

Premium GMC Infotainment System¹ with Google built-in,² 13.4" diagonal color touch-screen, multi-touch display, AM/FM stereo and Bluetooth^{®3} streaming audio for music and most smartphones; wireless Apple CarPlay^{®4} compatibility and wireless Android Auto⁵ compatibility for compatible phones; advanced voice recognition and personalized profiles for infotainment and vehicle settings

●

●

OnStar Premium Plan,⁶ includes 3-year trial subscription

●

●

SiriusXM[®] with 360L,⁷ includes 3-month trial

●

●

Super Cruise⁸ hands-free driver-assistance technology, includes 3-year trial subscription⁹

●

●

Adaptive Cruise Control¹⁰

●

●

Safety Alert Seat¹⁰

●

●

IntelliBeam—auto high beams

●

●

Forward Collision Alert¹⁰

●

●

Following Distance Indicator¹⁰

●

●

Front and Rear Park Assist¹⁰

●

●

● Standard ○ Available — Not Available

CONTINUED

¹Functionality varies by model. Full functionality requires compatible Bluetooth and smartphone, and USB connectivity for some devices. ²Google built-in services are subject to limitations, and availability may vary by vehicle, infotainment system and location. Select service plan required. Certain Google actions and functionality may require account linking. User terms and privacy statements apply. Google, Google Play and Google Maps are trademarks of Google LLC. ³The Bluetooth[®] word mark and logos are owned by Bluetooth SIG, Inc., and any use of such marks by General Motors is under license. Other trademarks and trade names are those of their respective owners. Go to my.gmc.com/learnabout/bluetooth to find out which phones are compatible with the vehicle. Full Bluetooth feature functionality varies by device, model and software version. ⁴Vehicle user interface is a product of Apple[®] and its terms and privacy statements apply. Requires compatible iPhone[®] and data plan rates apply. Apple CarPlay is a trademark of Apple, Inc. Siri, iPhone and iTunes are trademarks of Apple, Inc., registered in the U.S. and other countries. ⁵Vehicle user interface is a product of Google, and its terms and privacy statements apply. Wireless use of Android Auto requires a compatible Android 11.0+ phone and compatible active data plan. Check g.co/androidauto/requirements for compatibility. Android and Android Auto are trademarks of Google LLC. ⁶OnStar plan, working electrical system, cell reception and GPS signal required. OnStar links to emergency services. Service coverage varies with conditions and location. Service availability, features and functionality vary by device and software version. Data plans provided by AT&T. See onstar.com for details and limitations. ⁷Certain features require a SiriusXM subscription and the GMC Connected Access plan. See siriusxm.com and onstar.com for details and limitations. ⁸Always pay attention while driving and when using Super Cruise. Do not use a handheld device. Requires active Super Cruise plan or trial. Terms apply. Visit gmc.com/connectivity-technology/super-cruise for compatible roads and full details. ⁹After initial 3-year period, an eligible OnStar Super Cruise plan must be purchased. Plans vary by vehicle and model and require active service plan, working electrical system, cell reception and GPS signal. Does not include safety services. Super Cruise vehicles are connected to emergency services. See onstar.com for details and limitations. ¹⁰Safety or driver-assistance features are no substitute for the driver's responsibility to operate the vehicle in a safe manner. Read the vehicle Owner's Manual for important feature limitations and information.

YOUR HUMMER EV PICKUP AWAITS

KEY FEATURES

See your GMC dealer or gmc.com for more feature details and requirements.

2^x

3^x

SAFETY AND TECHNOLOGY CONTINUED

Enhanced Automatic Parking Assist ¹	●	●
High Definition Surround Vision ¹	●	●
UltraVision ² with underbody cameras (requires Extreme Off-Road Package)	○	○
Enhanced Automatic Emergency Braking ¹	●	●
Front Pedestrian Braking ¹	●	●
Rear Pedestrian Alert ¹	●	●
Rear Cross Traffic Alert ¹	●	●
Reverse Automatic Braking ¹	●	●
Automatic vehicle hold	●	●
Lane Keep Assist with Lane Departure Warning ¹	●	●
Lane Change Alert with Side Blind Zone Alert ¹	●	●
Trailer Side Blind Zone Alert ¹	●	●
Rear Seat Reminder ³	●	●
Teen Driver ¹	●	●

● Standard ○ Available — Not Available

¹Safety or driver-assistance features are no substitute for the driver's responsibility to operate the vehicle in a safe manner. Read the vehicle Owner's Manual for important feature limitations and information. ²Safety or driver-assistance features are no substitute for the driver's responsibility to operate the vehicle in a safe manner. Read the vehicle Owner's Manual for important feature limitations and information. Some camera views require available accessory camera and installation. Not compatible with all trailers. See your dealer for details. ³Does not detect people or items. Always check the rear seat before exiting.

SELECT PACKAGES

See your GMC dealer or [gmc.com](https://www.gmc.com) for more feature details and requirements.

2^x

EXTREME OFF-ROAD PACKAGE Includes 18" black aluminum wheels with machined accents, LT305/70R18 Goodyear Wrangler Territory MT tires, driver-selectable electronically locking front and rear differentials, full underbody skid plates (including front differential, battery and rear differential), underbody split forward- and rear-facing cameras,¹ black rear recovery hooks² and rocker protectors with assist steps

3^x

EXTREME OFF-ROAD PACKAGE Includes 18" black aluminum wheels with machined accents, LT305/70R18 Goodyear Wrangler Territory MT tires, driver-selectable electronically locking front and rear differentials, full underbody skid plates (including front differential, battery and rear differential), underbody split forward- and rear-facing cameras,¹ black rear recovery hooks² and rocker protectors with assist steps

OMEGA EDITION³ Includes Neptune Blue Matte⁴ exterior color, Infinity Roof transparent Sky Panels, black emblems, MultiPro Audio System by KICKER[®],⁵ Thatcham wheel locks, 18" gloss-black beadlock-capable wheels with Carbon Flash decorative rings, wheel center caps in black with HUMMER EV logo and premium carpet floor inserts

¹Safety or driver-assistance features are no substitute for the driver's responsibility to operate the vehicle in a safe manner. Read the vehicle Owner's Manual for important feature limitations and information. ²To avoid the risk of injury, never use recovery hooks to tow a vehicle. For more information, see the Recovery Hooks section of the vehicle Owner's Manual. ³Requires Extreme Off-Road Package. See dealer for details. ⁴Special care required for matte paint. Read the vehicle Owner's Manual for more details. ⁵Non-GM warranty. Limited warranty by KICKER[®], 3 years/36,000 miles, whichever comes first. For more information, contact your dealer.

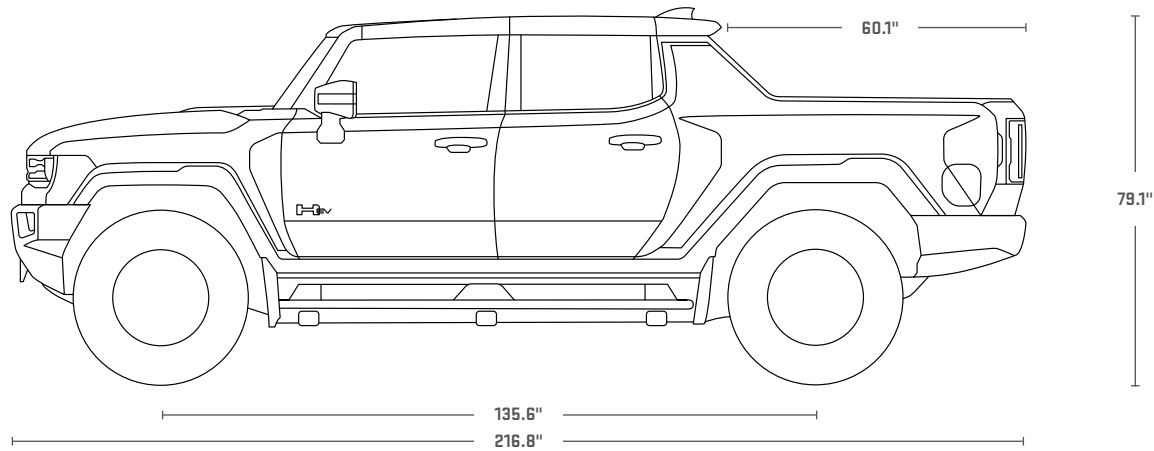
**WHEELBASE**

135.6"

OVERALL LENGTH

216.8"

OVERALL WIDTH (WITH MIRRORS)

93.7"

OVERALL WIDTH (MIRRORS FOLDED)

87.5"

OVERALL WIDTH (WITHOUT MIRRORS)

86.7"

OVERALL HEIGHT

79.1"

LEG ROOM (FIRST/SECOND ROW)

45.6"/38.9"

HEAD ROOM (FIRST/SECOND ROW)

42.5"/38.6"

SHOULDER ROOM (FIRST/SECOND ROW)

63.9"/64.0"

HIP ROOM (FIRST/SECOND ROW)

60.5"/60.3"

FRONT OVERHANG

34.7"

REAR OVERHANG

46.5"

GROUND CLEARANCE, STANDARD

10.1"

GROUND CLEARANCE, TERRAIN MODE (IF EQUIPPED)

11.9"

GROUND CLEARANCE, EXTRACT MODE (IF EQUIPPED)

15.9"

WATER FORDING,¹ STANDARD

26.0"

WATER FORDING,¹ TERRAIN MODE (IF EQUIPPED)

28.0"

WATER FORDING,¹ EXTRACT MODE (IF EQUIPPED)

32.0"

INSIDE BED HEIGHT

21.7"

INSIDE BED LENGTH AT FLOOR

60.1"

BED WIDTH BETWEEN WHEELHOUSING

50.0"

BED WIDTH WALL TO WALL

61.0"

MAX CARGO VOLUME, CARGO BED²

36.7 cu. ft.

MAX CARGO VOLUME, eTRUNK²

11.3 cu. ft.

SUSPENSION TRAVEL (FRONT AND REAR)

13.0"

TURN CIRCLE (4-WHEEL STEERING, IF EQUIPPED)

37.1 ft.

TURN CIRCLE (2-WHEEL STEERING)

44.3 ft.



KEY TRAILERING FEATURES

- | Up to 18 available camera views¹
- | ProGrade Trailering System with available in-vehicle Trailering App²
- | Tow/Haul mode
- | Smart trailer integration indicator
- | Trailering package includes trailer hitch, 7-pin connector and Hitch Guidance³
- | GMC MultiPro Tailgate
- | Hitch Guidance³ with Hitch View³
- | Trailer brake controller
- | Air Ride Adaptive Suspension

KEY SPECIFICATIONS

- | Maximum available trailering: up to 12,000 lbs⁴ (7,500 lbs⁴ as shown)
- | Maximum available torque: up to 11,500 lb-ft⁵
- | Maximum available horsepower: up to 1,000 hp⁵
- | Maximum available payload: up to 1,485 lbs⁶
- | Maximum cargo bed volume: 36.7 cu. ft.⁷
- | Maximum front eTrunk volume: 11.3 cu. ft.⁷
- | 8 cargo tie-downs in bed rated at 500 lbs⁷ per corner
- | 4 cargo tie-downs in eTrunk rated at 110 lbs⁷
- | Maximum available seating capacity of 5

POWERTRAINS

- | Available Ultium Drive System Performance Torque Vectoring e4WD—3 motors (1 front, 2 rear) with 24-module Ultium Battery Pack
- | Available Ultium Drive System Performance Torque Vectoring e4WD—3 motors (1 front, 2 rear) with 20-module Ultium Battery Pack
- | Available Ultium Drive System Performance e4WD—2 motors (1 front, 1 rear) with 20-module Ultium Battery Pack

¹Safety or driver-assistance features are no substitute for the driver's responsibility to operate the vehicle in a safe manner. Read the vehicle Owner's Manual for important feature limitations and information. Some camera views require available accessory camera and installation. Not compatible with all trailers. See your dealer for details. ²App functionality and features vary with vehicle equipment and trim level. Data connection may be required. Some features require active service plan and working electrical system. Terms and limitations apply. ³Safety or driver-assistance features are no substitute for the driver's responsibility to operate the vehicle in a safe manner. Read the vehicle Owner's Manual for important feature limitations and information. ⁴12,000-lb rating requires a GMC HUMMER EV 2^x Pickup. 7,500-lb rating requires a GMC HUMMER EV 3^x Pickup with Extreme Off-Road Package. Maximum trailering ratings are intended for comparison purposes only. Before you buy a vehicle or use it for trailering, carefully review the trailering section of the Owner's Manual. The trailering capacity of your specific vehicle may vary. The weight of passengers, cargo and options or accessories may reduce the amount you can trailer. ⁵GM-estimated. Requires HUMMER EV 3^x Pickup with available 24-module battery pack. ⁶Requires properly equipped GMC HUMMER EV 2^x Pickup. These maximum payload ratings are intended for comparison purposes only. Before you buy a vehicle or use it to haul people or cargo, carefully review the vehicle loading section of the Owner's Manual and check the carrying capacity of your specific vehicle on the label on the inside of the driver's doorjamb. ⁷Cargo and load capacity limited by weight and distribution.

ULTIUM DRIVE SYSTEMS

MODEL	CAB	BED	MAX CONVENTIONAL TRAILER WEIGHT RATING (LBS) ¹	MAX PAYLOAD RATING (LBS) ²
HUMMER EV 2 ^x Pickup with 20-module Ultium Battery Pack	Crew Cab e4WD/2 motors	Short	12,000	1,485
HUMMER EV 3 ^x Pickup with 20-module Ultium Battery Pack	Crew Cab e4WD/3 motors	Short	8,500	1,220
HUMMER EV 3 ^x Pickup with 24-module Ultium Battery Pack	Crew Cab e4WD/3 motors	Short	8,500	1,300

ELECTRIC DRIVE SPECIFICATIONS

MODEL	BATTERY PACK	LEVEL 2 CHARGING ³	MAXIMUM CHARGING CAPABILITIES	DRIVE SYSTEM	HORSEPOWER ⁴	TORQUE ⁴
HUMMER EV 2 ^x Pickup	Available 20-module Ultium Battery Pack	Up to nearly 30 miles in 1 hour ⁴	DC fast charging available. ⁵ Approximately 100 miles in as little as 14 minutes ⁴ (up to 300 kW) with a compatible DC fast charger. ⁶	Ultium Drive System Performance e4WD (electronic 4WD); 2 motors (1 front, 1 rear)	625 hp/570 hp ⁷	7,400 lb-ft
HUMMER EV 3 ^x Pickup	Available 20-module Ultium Battery Pack	Up to nearly 30 miles in 1 hour ⁴	DC fast charging available. ⁵ Approximately 100 miles in as little as 14 minutes ⁴ (up to 300 kW) with a compatible DC fast charger. ⁶	Ultium Drive System Performance Torque Vectoring e4WD (electronic 4WD); 3 motors (1 front, 2 rear)	830 hp	11,500 lb-ft
HUMMER EV 3 ^x Pickup	Available 24-module Ultium Battery Pack	Up to nearly 30 miles in 1 hour ⁴	DC fast charging available. ⁵ Approximately 100 miles in as little as 11 minutes ⁴ (up to 350 kW) with a compatible DC fast charger. ⁶	Ultium Drive System Performance Torque Vectoring e4WD (electronic 4WD); 3 motors (1 front, 2 rear)	1,000 hp	11,500 lb-ft

¹Maximum trailering ratings are intended for comparison purposes only. Before you buy a vehicle or use it for trailering, carefully review the trailering section of the Owner's Manual. The trailering capacity of your specific vehicle may vary. The weight of passengers, cargo and options or accessories may reduce the amount you can trailer. ²These maximum payload ratings are intended for comparison purposes only. Before you buy a vehicle or use it to haul people or cargo, carefully review the vehicle loading section of the Owner's Manual and check the carrying capacity of your specific vehicle on the label on the inside of the driver's doorjamb. ³Requires professional installation of a compatible wall charger, sold separately. Actual charge times will vary based on battery condition, output of charger, vehicle settings and battery temperature. See the Owner's Manuals for your vehicle and charger for additional details and limitations. ⁴GM-estimated. ⁵Actual charge times will vary based on battery starting state of charge, battery condition, output of charger, vehicle settings and battery temperature. See the Owner's Manuals for your vehicle and charger for additional details and limitations. ⁶Requires use of compatible public DC fast chargers. ⁷625 hp rating when equipped with available Extreme Off-Road Package.



PROGRADE TRAILERING SYSTEM

GMC’s available ProGrade Trailing System includes advanced technologies for increased views and confidence. It helps when hooking up your trailer, while on the road and when backing your trailer into place.



myGMC MOBILE APP⁴

The available myGMC Mobile App⁴ allows you to create and manage trailer profiles, run a Trailer Light Sequence Test to help ensure trailer lights are in working order, reference predeparture checklists and use a Trailer Load Calculator to determine the combined weight of your vehicle and trailer. You can view and receive alerts on key components of your trailer such as tire pressure monitoring³ and trailer miles. There’s also a glossary filled with trailering-related materials.

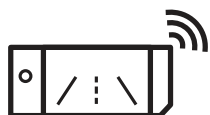

IN-VEHICLE TRAILERING APP¹

The available in-vehicle Trailing App¹ is integrated into the infotainment system² and includes the ability to create five defined trailer profiles based on trailer name, trailer type and trailer hitch type. There are also maintenance reminders, predeparture checklists, a Trailer Light Sequence Test, a Trailer Tire Pressure Monitoring System,³ a counter for trailer mileage and other features.

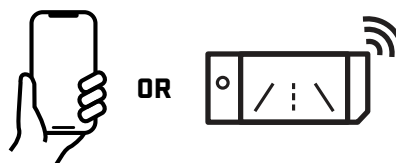

SMART TRAILER INTEGRATION

The available ASA Electronics iN•Command[®] Control System⁵ is designed to integrate with and be accessible through the myGMC Mobile App⁴ (on compatible iPhones[®] and Android[™] smartphones) or on the infotainment system via Apple CarPlay^{®6} and Android Auto⁷ compatibility. The iN•Command Control System allows you to monitor and control a range of smart system functions such as water tank levels, climate controls and power slide-outs in recreational trailers equipped with GlobalConnect technology.

¹App functionality and features vary with vehicle equipment and trim level. Data connection may be required. Some features require active service plan and working electrical system. Terms and limitations apply. ²Functionality varies by model. Full functionality requires compatible Bluetooth and smartphone, and USB connectivity for some devices. ³Requires available Trailer Tire Pressure Monitoring System and installation of trailer tire pressure monitor sensors. ⁴Available on select Apple[®] and Android devices. Service availability, features and functionality vary by vehicle, device and the plan you are enrolled in. Terms apply. Device data connection required. See onstar.com for details and limitations. ⁵iN•Command is provided by ASA Electronics and is designed to operate within 30 feet of the trailer. Works with trailers equipped with iN•Command Control System with GlobalConnect via Bluetooth connection. Control and monitoring functionality varies by trailer manufacturer model and installed options. Use of the iN•Command Control System feature through the myGMC Mobile App requires an active service plan. User terms apply. See onstar.com for details and limitations. ⁶Vehicle user interface is a product of Apple[®] and its terms and privacy statements apply. Requires compatible iPhone[®] and data plan rates apply. Apple CarPlay is a trademark of Apple, Inc. Siri, iPhone and iTunes are trademarks of Apple, Inc., registered in the U.S. and other countries. ⁷Vehicle user interface is a product of Google, and its terms and privacy statements apply. Wireless use of Android Auto requires a compatible Android 11.0+ phone and compatible active data plan. Check g.co/androidauto/requirements for compatibility. Android and Android Auto are trademarks of Google LLC.



Sierra Light Duty shown.

INNOVATIVE WAYS TO TAKE CONTROL

The available myGMC Mobile App¹ helps elevate your ownership experience in many ways. It's also a powerful and useful tool when it comes to trailering.

IN A PROPERLY EQUIPPED VEHICLE, YOU'LL HAVE THESE USEFUL FUNCTIONS AT YOUR FINGERTIPS:

- | Trailer Light Sequence Test
- | Load calculator
- | Predeparture checklists
- | Profile sharing
- | Glossary of terms
- | Trailer tire pressure alerts²
- | Maintenance reminders
- | Smart trailer controls

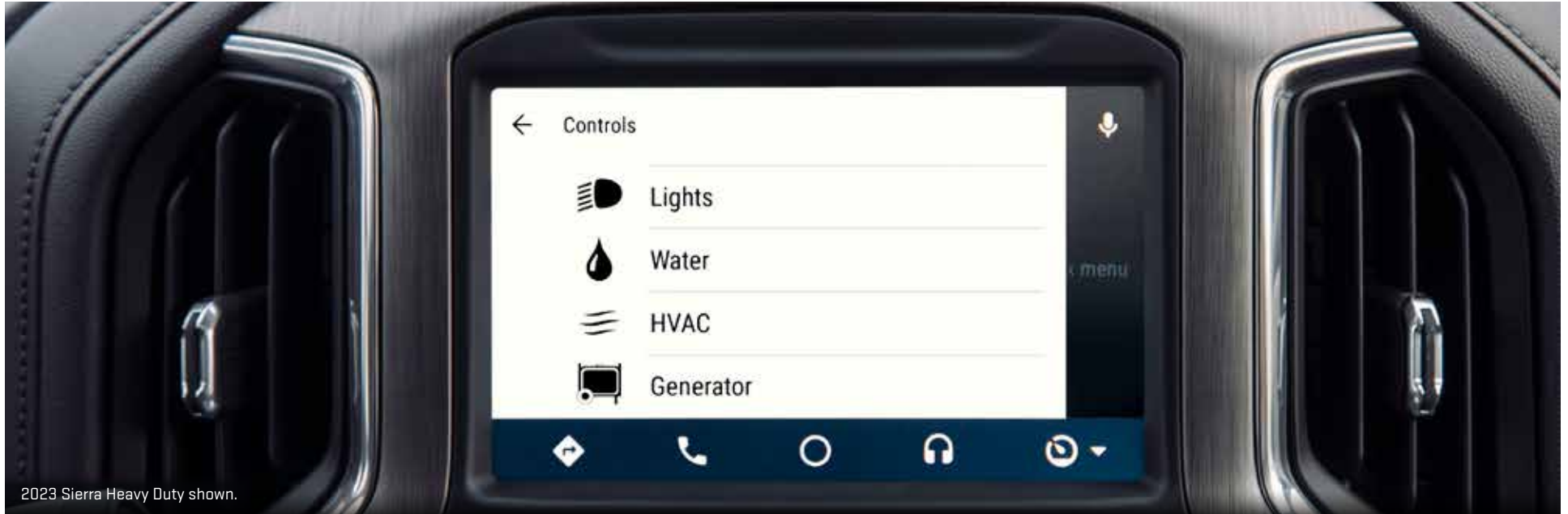

2023 Sierra Heavy Duty shown.

PUTTING YOU IN COMMAND LIKE NEVER BEFORE

The available Smart Trailer Control System effectively turns your smartphone into a remote control. Accessible through the available myGMC Mobile App¹ (on compatible iOS and Android smartphones) or through the infotainment system (via Apple CarPlay^{®2} and Android Auto³ compatibility), the Smart Trailer Control System allows you to control many of your compatibly equipped iN•Command Control System⁴ trailer functions through a Bluetooth⁵ connection. It's a seamless way to stay informed and in command.

TAKE CONTROL OF THE FOLLOWING FUNCTIONS AND SYSTEMS IN YOUR COMPATIBLE ATTACHED TRAILER:

- | Adjust climate controls
- | Turn the water pump on/off
- | Turn the heater on/off
- | Turn interior lights on/off
- | Turn exterior lights on/off
- | Check real-time status of the water tank level
- | Check real-time status of the battery life
- | Check fuel level of the generator
- | Prime and start the generator
- | Open and close slide-outs (vehicle and trailer must be parked)
- | Open and close awnings (vehicle and trailer must be parked)
- | Adjust jacks (vehicle and trailer must be parked)

¹Available on select Apple[®] and Android devices. Service availability, features and functionality vary by vehicle, device and the plan you are enrolled in. Terms apply. Device data connection required. See onstar.com for details and limitations. ²Vehicle user interface is a product of Apple[®] and its terms and privacy statements apply. Requires compatible iPhone[®] and data plan rates apply. Apple CarPlay is a trademark of Apple, Inc. Siri, iPhone and iTunes are trademarks of Apple, Inc., registered in the U.S. and other countries. ³Vehicle user interface is a product of Google, and its terms and privacy statements apply. Wireless use of Android Auto requires a compatible Android 11.0+ phone and compatible active data plan. Check g.co/androidauto/requirements for compatibility. Android and Android Auto are trademarks of Google LLC. ⁴iN•Command is provided by ASA Electronics and is designed to operate within 30 feet of the trailer. Works with trailers equipped with iN•Command Control System with GlobalConnect via Bluetooth connection. Control and monitoring functionality varies by trailer manufacturer model and installed options. Use of the iN•Command Control System feature through the myGMC Mobile App requires an active service plan. User terms apply. See onstar.com for details and limitations. ⁵The Bluetooth[®] word mark and logos are owned by Bluetooth SIG, Inc., and any use of such marks by General Motors is under license. Other trademarks and trade names are those of their respective owners. Go to my.gmc.com/learnabout/bluetooth to find out which phones are compatible with the vehicle. Full Bluetooth feature functionality varies by device, model and software version.

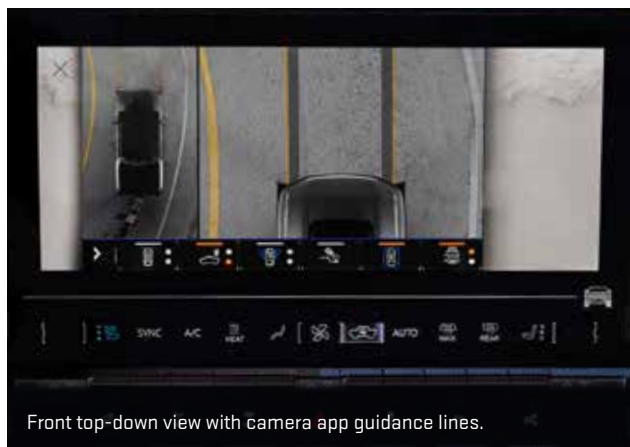

UP TO
18 AVAILABLE
CAMERA VIEWS¹

- 1. Transparent trailer view (requires compatible conventional trailer)
- 2. Hitch View
- 3. Bed view
- 4. Front standard view
- 5. Rear standard view
- 6. Guidance lines
- 7. Surround view
- 8. Front top-down view
- 9. Rear top-down view
- 10. Rear bowl view
- 11. Front side view
- 12. Rear side view (with available articulation functionality) (requires compatible conventional trailer)
- 13. Rear trailer view (requires compatible conventional trailer)
- 14. Hitch Guidance
- 15. Picture-in-picture side view
- 16. Rear Camera Mirror
- 17. Forward-facing underbody view
- 18. Rear-facing underbody view

¹Safety or driver-assistance features are no substitute for the driver's responsibility to operate the vehicle in a safe manner. Read the vehicle Owner's Manual for important feature limitations and information. Some camera views require available accessory camera and installation. Not compatible with all trailers. See your dealer for details.

CAMERA-VIEW COMPATIBILITY

ALL TRAILERS MAY NOT BE COMPATIBLE. THIS CHART IS FOR REFERENCE ONLY.

CAMERA VIEW	TRAILER TYPE	DIMENSIONS REQUIRED
Rear trailer view with Trailer Angle Indicator ¹	Box/enclosed ²	Yes
Rear trailer view ¹	Most	N/A
Rear side view	Most	N/A
Rear side view with trailer biasing	Box/enclosed ²	Yes
Rear side view with Trailer Length Indicator (turn-signal activated)	Box/enclosed ²	Yes
Transparent trailer view ³	Box/enclosed ²	Yes
Jack-Knife Alert	Box/enclosed ²	Yes
Picture-in-picture side view ¹	Most	N/A
Inside trailer view ¹	Most	N/A
Bed view	N/A	N/A
Bed view with zoom and Hitch Guidance	N/A	N/A
Hitch View	Most	N/A

Safety or driver-assistance features are no substitute for the driver's responsibility to operate the vehicle in a safe manner. The driver should remain attentive to traffic, surroundings and road conditions at all times. Visibility, weather and road conditions may affect feature performance. Read the vehicle Owner's Manual for more important feature limitations and information.

¹Requires available accessory camera and installation. Not compatible with all trailers. See your dealer for details. ²Box/enclosed trailer is a type of trailer that has walls and a roof to completely enclose cargo and keep it protected from the elements. ³Requires available accessory camera and installation. Not compatible with all trailers. This camera view has a trailer-length limitation. Read the vehicle Owner's Manual or see your dealer for details.

FOLLOW THESE CALIBRATION TIPS FOR SUCCESSFUL SETUP:**01.
DRIVE BELOW 31 MPH**

Driving faster may delay calibration.

**02.
DRIVE STRAIGHT**

Excessive steering may extend calibration time.

**03.
USE GOOD LIGHT**

Calibration should be attempted when there is enough light.

**04.
SET UP IN GOOD WEATHER**

Calibration during snow or heavy rain should be avoided.

**05.
USE A FLAT, DEFINED ROAD**

Avoid gravel, dirt or unmarked roads.

**06.
USE THE PROPER CONNECTION**

Ensure that the camera is connected to the correct input.

**07.
USE THE CORRECT LOCATION**

The accessory camera should be mounted and angled inside the defined mounting location (see camera installation instructions).

**08.
CHECK FOR A CLEAN LENS**

Cameras obstructed by dirt or debris may hinder calibration.

**09.
CHECK FOR A CLEAR VIEW**

The accessory trailer camera should have an unobstructed view (no spare tire, bike/cargo racks, etc.). Shadows may be perceived as obstructions. Attempt to calibrate while driving in an alternate direction if possible.

**10.
ENSURE DIMENSIONS
ARE CORRECT**

Enter accurate measurements made to the nearest inch.

**11.
MEASURE CORRECTLY**

Use the width of the box of the trailer. Do not include the width of the wheels. This helps transparent trailer view and Jack-Knife Alert to work accurately.

**12.
MEASURE V-NOSE
TRAILERS CORRECTLY**

For V-nose trailers, when measuring the distance between the ball and the front of the trailer, you should measure the distance to the widest part of the trailer, not to the point on the nose.

Safety or driver-assistance features are no substitute for the driver's responsibility to operate the vehicle in a safe manner. The driver should remain attentive to traffic, surroundings and road conditions at all times. Visibility, weather and road conditions may affect feature performance. Read the vehicle Owner's Manual for more important feature limitations and information.

Transparent trailer view requires available accessory camera and installation. Not compatible with all trailers. This camera view has a trailer-length limitation. Read the vehicle Owner's Manual or see your dealer for details.

SELECT TRAILERING TECHNOLOGY AVAILABILITY BY TRIM

For more information on these technologies, visit gmc.com.

	2 ^x	3 ^x
TRAILERING TECHNOLOGY		
In-vehicle Trailering App ¹	○	○
myGMC Mobile App ²	○	○
Smart trailer integration indicator	●	●
Tow/Haul mode	●	●
Electric Parking Brake	●	●
Enhanced Automatic Parking Assist ³	●	●
Hill Start Assist	●	●
Integrated Trailer Brake Controller	●	●
Trailer Sway Control	●	●
Hitch Guidance ³	●	●
Trailer Vision rear view ³	●	●

● Standard ○ Available — Not Available

CONTINUED

¹App functionality and features vary with vehicle equipment and trim level. Data connection may be required. Some features require active service plan and working electrical system. Terms and limitations apply. ²Available on select Apple® and Android devices. Service availability, features and functionality vary by vehicle, device and the plan you are enrolled in. Terms apply. Device data connection required. See onstar.com for details and limitations. ³Safety or driver-assistance features are no substitute for the driver's responsibility to operate the vehicle in a safe manner. Read the vehicle Owner's Manual for important feature limitations and information.

SELECT TRAILERING TECHNOLOGY AVAILABILITY BY TRIM

For more information on these technologies, visit gmc.com.

TRAILERING TECHNOLOGY CONTINUED

High Definition Surround Vision¹

Trailer hitch

7-pin connector

Up to 18 camera views,² including transparent trailer view

Rear trailer guidelines with Trailer Angle Indicator

Trailer Length Indicator

Auxiliary trailer camera—wired

Jack-Knife Alert

2^x

3^x



● Standard ○ Available — Not Available

¹Safety or driver-assistance features are no substitute for the driver's responsibility to operate the vehicle in a safe manner. Read the vehicle Owner's Manual for important feature limitations and information. ²Safety or driver-assistance features are no substitute for the driver's responsibility to operate the vehicle in a safe manner. Read the vehicle Owner's Manual for important feature limitations and information. Some camera views require available accessory camera and installation. Not compatible with all trailers. See your dealer for details.

TRAILER HITCH STYLES

SELECTING THE RIGHT HITCH

Choosing the right hitch, while ensuring proper electrical connections are made, affects how your vehicle handles, corners and brakes, and allows you to alert other drivers of your intentions. Before selecting a hitch or trailering package, you should be familiar with the weight ratings specific to your GMC vehicle.

CONVENTIONAL TRAILER HITCH

HUMMER EV Pickup is equipped with a trailer hitch receiver that, when properly equipped, will enable towing of conventional trailers. This style of trailer is typically used to describe recreational trailers, such as campers or boat trailers. Conventional trailers generally utilize a ball-type hitch.

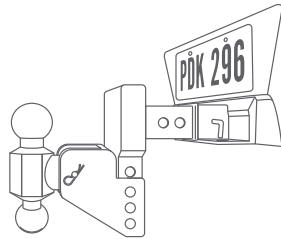

CONVENTIONAL TRAILER HITCH



HITCH BALL ON DRAW BAR

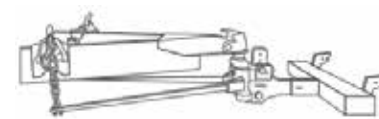

WEIGHT-DISTRIBUTING HITCH

WEIGHT-CARRYING HITCH

This consists of a hitch ball mounted on a step bumper or draw bar, or a tow eye latched to a pintle hook. Hitch balls are available in a range of sizes. Make sure that the diameter of your hitch ball matches your trailer coupler. Also check that the ball and ball mount meet or exceed the Gross Trailer Weight Rating.

WEIGHT-DISTRIBUTING HITCH

This is most often used for heavier trailering. This hitch type more evenly distributes the trailer load by using spring bars to shift some of the hitch weight forward onto the tow vehicle's front axle and rearward to the trailer's axles.

KEY AVAILABLE ACCESSORIES



MULTIPRO AUDIO SYSTEM BY KICKER^{®1}



SOFT ROLL-UP TONNEAU COVER



ROCKER PROTECTORS WITH ASSIST STEPS



D-RING RECOVERY HOOK² IN BLACK



UNDERSEAT ORGANIZER AND I-BAR STORAGE



FRONT OFF-ROAD AUXILIARY LIGHTS

¹Non-GM warranty. Limited warranty by KICKER, [®] 3 years/36,000 miles, whichever comes first. For more information, contact your dealer. ²To avoid the risk of injury, never use recovery hooks to tow a vehicle. For more information, see the Recovery Hooks section of the vehicle Owner's Manual. ©2024 General Motors. All rights reserved. The marks appearing here are the trademarks or service marks of GM, its subsidiaries, affiliates or licensors.

SCAN
TO SEE
ALL

