

2025

Outback

Accessories









Genuine Subaru Outback Accessories

Breaking boundaries.

Your 2025 Subaru Outback is designed with legendary capability, versatility and safety to take you on any journey, whether minutes from home or miles away. With Genuine Subaru Accessories, you'll be equipped for adventures of a lifetime.

CONTENTS

 Protection and Security	4-9
 Audio / Media	10
 Lifestyle	11-20
 Comfort and Convenience	21-24
 Pet-friendly	25-29
 Style.....	30-34



Genuine Subaru Accessories are backed by the vehicle's 3-year or 36,000-mile limited warranty, even if the accessory is installed after retail delivery. Genuine Subaru Accessories installed after the 3-year/36,000-mile warranty period are backed by a 1-year, unlimited mileage warranty. See your warranty and maintenance booklet for more details.

Genuine Subaru Lifestyle Accessories by Thule® have a limited lifetime warranty for the original purchaser.

Prepared to pursue the toughest trails.

Rugged, versatile and designed to tackle rougher terrain, your 2025 Subaru Outback Wilderness will reveal new territory to discover. Explore the collection of Genuine Subaru Accessories for the Outback Wilderness on the following pages and take your adventurous spirit to the next level.





All-Weather Floor Liners

High wall design helps protect the vehicle carpet from spills, snow, sand, mud, dirt and moisture.

- ◆ *Engineered to precisely fit the Outback footwell area.*
- ◆ *Constructed with durable materials to help minimize warping, fading or tearing vs. aftermarket alternatives.*

J501SAN100

Not intended for use on top of Carpeted Floor Mats.

Outback Wilderness-branded All-Weather Floor Liners are factory-installed on Outback Wilderness.



Carpeted Floor Mats

Heavy-duty construction helps protect vehicle carpet and enhances the appearance of the cabin area.

- ◆ *Driver's side mat anchors to two factory mounts to maintain proper position and meet all safety requirements.*
- ◆ *Anti-skid backing prevents movement of the mat.*
- ◆ *Color-matched stitching complements the Outback Wilderness logo and interior stitching.*

J501SAN060 (Outback Wilderness only)

Outback-branded Carpeted Floor Mats are factory-installed on all other Outback trims.

Ready for any road.

Whether traveling tough terrain or along the highway, your Subaru Outback is reliable and equipped for any excursion. Help keep its adventure-ready practicality and distinctive style intact with the addition of Genuine Subaru Accessories.



Extensive testing is performed on Genuine Subaru Accessories to help ensure strict Subaru engineering specifications and safety requirements are met.



Door Edge Guards

Help protect your door edges from dings and chips with custom-fit, body color-matched, stainless steel Door Edge Guards. They help preserve the appearance of your Subaru while seamlessly blending into the door design.

- SOA801P061M6 (Autumn Green Metallic)**
- SOA801P061M8 (Cosmic Blue Pearl)**
- SOA801P061T1 (Crimson Red Pearl)**
- SOA801P061V3 (Crystal Black Silica)**
- SOA801P061W7 (Crystal White Pearl)**
- SOA801P061P7 (Dark Mahogany Pearl)**
- SOA801P061H6 (Geyser Blue)**
- SOA801P061TR (Ice Silver Metallic)**
- SOA801P061M4 (Magnetite Gray Metallic)**

Geyser Blue applicable to Outback Wilderness only.



Side Window Deflectors

Keep inclement weather out and allow fresh air in.

- ✦ *Engineered with the vehicle for a seamless fit and complementary appearance vs. aftermarket parts.*
- ✦ *Evaluated for water intrusion.*
- ✦ *Tested to help reduce wind noise and vibration.*

- F001SAN000 (Chrome)**
- F001SAN100 (Black)**

Black applicable to Outback Wilderness and Onyx Edition. May not be legal in all states. Please check the laws of your state.



Body Side Molding

Attractive, color-matched moldings coordinate with the styling of the vehicle while helping to protect doors from unsightly dings.

- J101SAN801M6 (Autumn Green Metallic)**
- J101SAN801M8 (Cosmic Blue Pearl)**
- J101SAN801T1 (Crimson Red Pearl)**
- J101SAN801V3 (Crystal Black Silica)**
- J101SAN801W7 (Crystal White Pearl)**
- J101SAN801P7 (Dark Mahogany Pearl)**
- J101SAN801H6 (Geyser Blue)**
- J101SAN801TR (Ice Silver Metallic)**
- J101SAN801M4 (Magnetite Gray Metallic)**

Geyser Blue applicable to Outback Wilderness only.



Battery Charger and Maintainer

Custom engineered for Subaru vehicles, the Battery Charger and Maintainer efficiently charges 12-volt lead acid batteries to maximize battery life. Comes with alligator clamps for quick connections and ring-terminals for more permanent connections, to help ensure your vehicle's battery is ready for your next adventure.

- ◆ Fully automatic charging with LED lights and countdown timer to indicate remaining charge time.
- ◆ 'Try' LED light indicates when you can attempt to start your vehicle.
- ◆ 'Reconditioning' mode restores deeply discharged batteries.
- ◆ Reverse polarity protection.
- ◆ Designed with a rubber bumper to protect both the accessory and the vehicle during use.

SOA9010001



Rear Seatback Protector

Provides additional protection to the rear seatbacks when lowering the seats to transport larger cargo. Use in conjunction with the Cargo Tray for optimal protection.

J501SAN222



Cargo Sidewall Protector

Extend protection to the cargo area wheel well trim panels. Set of two.

- ◆ Engineered for a precise fit vs. aftermarket parts.
- ◆ Texture- and pattern-matched with the Rear Seatback Protector and Cargo Tray to create a seamless appearance.

J501SAN260



Rear Bumper Cover

Helps protect the upper surface of the painted bumper from scratches and scuffs.

E771SAN100

Not applicable to Outback Wilderness.



Rear Door Sill Step Guard

Protect your door sill with the step guard to confidently reach your roof top gear when extra height is needed.

J1010AN400



Door Scuff Protector

A durable, easy to clean plastic shell that protects your doors from common shoe scuffs and other scrapes when entering and exiting your vehicle. The unique texture complements the design of the Outback. Comes in a set of four.

J131SAN000

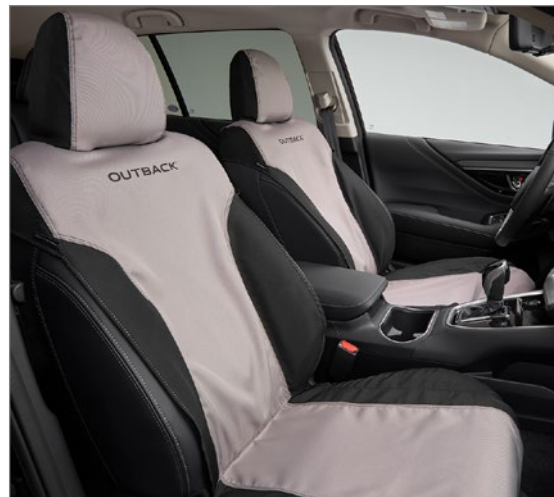

Seat Cover – Front

Keep your front seats tidy and protect them from spills, stains, dust and dirt. Great for life on the go.

- ✦ Custom-fitted, machine-washable and water-resistant.
- ✦ Made with a polyester front and polyurethane coated back.
- ✦ Full coverage to help protect seatbacks from wear and tear.
- ✦ Slips into the seatback pocket to help prevent damage to pocket upholstery.

F411SAN101 (Limited and Touring trims)

F411SAN111 (Base and Premium trims, Onyx Edition and Outback Wilderness)

Battery Warmer

Warms vehicle's battery for easier starting in extremely cold weather. Plugs into a household electrical outlet.

J601SFJ000



Engine Block Heater

Warms engine coolant to promote easier starting in extreme cold conditions. Plugs into a household electrical outlet.

A091SAN000



Wheel Locks – Alloy

Bright chrome wheel locks help to deter theft of wheels and tires. Includes four locks and key.

B321SFL000



Wheel Lug Nut and Lock Set – Black

Match your dark colored wheels by changing all lug nuts to black for improved styling. Includes four locks and key to help deter theft of wheels and tires.

B321SFL020

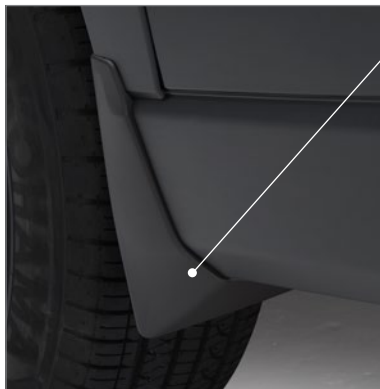

Splash Guards

Help protect vehicle paint finish from stones and road grime.

- ★ *Engineered to help reduce wind noise and aerodynamic drag.*
- ★ *Undergo a series of durability tests to help withstand weather and driving conditions.*

J101SAN100

J101SAN150 (Outback Wilderness)

Ground clearance is reduced when Splash Guards are installed.

Cannot be used in conjunction with Mud Flaps.



Mud Flaps

Help protect the paint finish from chips and the undercarriage from rust and corrosion. Includes Outback logo. Special edition for Outback Wilderness.

- ★ *Serve as a protective barrier between the tires and wheel well.*
- ★ *Help minimize water, dirt and mud spray.*
- ★ *Evaluated for durability and to withstand various weather conditions.*

J101SAN300

J101SAN400 (Outback Wilderness)

Cannot be used in conjunction with Splash Guards.

Outback
Wilderness





Auto-Dimming Exterior Mirror with Approach Light

LED lights in each exterior mirror illuminate the ground next to and towards the rear of the vehicle upon approaching the vehicle or unlocking your doors with the keyless entry system. During nighttime driving, mirrors dim in unison with the rearview mirror to reduce headlight glare. Requires Auto-Dimming (Interior) Mirror.

- ★ *Enhances nighttime driving safety.*
- ★ *Dimming level is regulated by level of light detected by Auto-Dimming (Interior) Mirror.*

J201SAN300

For Touring trims, vehicle must be unlocked to unfold side mirrors, allowing the approach light to illuminate next to and towards the rear of the vehicle.



Severe Weather Companion

The Severe Weather Companion contains just about everything needed to handle an unexpected weather emergency while traveling. Included are items which help provide the basic necessities such as warmth, light, water, first aid, and the ability to signal for help; all packaged in a handy padded canvas carrying case.

SOA868V9502



Roadside Emergency Kit

The Genuine Subaru Roadside Emergency Kit contains a range of essential items to assist you in an automotive emergency. Including jumper cables, a reflective triangle, a first aid kit and more.

The kit is designed to help keep you safe and dry – and get you on the road again. The components of the kit are packaged in a padded, embroidered carrying case.

SOA868V9511



First Aid Kit

Contains practical supplies to treat minor scrapes and scratches. The kit includes an assortment of self-adhesive bandages and gauze, adhesive tape, scissors, tweezers, an emergency blanket, a first aid guide and more. Contents are packaged in a zippered, Subaru-branded bag for easy accessibility.

SOA9031300





Hear the call of adventure.

Your passion for adventure will lead you to destinations you'll love. Wherever you may roam, add a soundtrack to your travels and stay connected with Genuine Subaru Accessories.



CD Player

Add a single disc CD player to your center console for another way to enjoy your audio.

H621SAN000

Standard on Touring trims.



Wireless Charger

Conveniently charge your phone without the hassle of tangled wires. The Wireless Charger is a Qi Certified Device with intelligent charging profiles, cell phone battery protection, temperature control technology and short circuit safeguards. Compatible with all Qi enabled devices.

H671SAN202 (Excludes Base trim)

Tweeter Kit

Special speakers enhance high-frequency audio responses and improve stereo imaging.

H630SAN100 (Base trim only)



USB Charging Cables

Quickly charge mobile devices while you're on the go. Designed in signature Subaru blue, Genuine Subaru cables offer superior quality and durability compared to typical aftermarket cables. Packaged in a zippered Subaru-branded storage case, the set of four, 3 ft. cables allow you and your passengers to charge and connect while on the road.

- ◆ Includes Velcro® cable ties to keep cables neat, tidy and organized when not in use
- ◆ Universal compatibility designed to work flawlessly with any device that uses a USB-A or USB-C port.
- ◆ Includes MFi-certified, unique and verified serial number and authorization chip issued by Apple® to ensure compatibility with any Lightning® device.
- ◆ Supports multiple charging specifications; USB-A to Lightning, USB-C to Lightning, USB-A to USB-C, USB-C to USB-Power Delivery, Qualcomm® Quick Charge™, Samsung® adaptive charging, Android Auto™ and Apple CarPlay® using the USB media port.



H671SFN000

Load up for the life you love.

Let a map or your intuition guide you. Your Subaru Outback is rugged, reliable and ready to take on the next great adventure. Pack up all the gear you need as you head for the horizon with Genuine Subaru Lifestyle Accessories.



Thule® Portable Step

Get the extra height you need to easily access all of your roof top Lifestyle Accessories with the convenience of the Thule® Portable Step. Constructed of heavy-duty steel; rubber bumpers are included to help prevent wheel scrapes and scuffs. This step conveniently folds into a carrying bag for easy storage.

SOA567W010

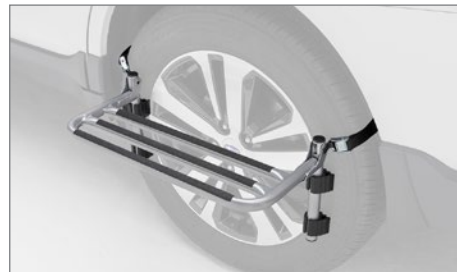

Thule® Crossbar Set – Aero Extended (Black)

Increases cargo-carrying capabilities of the Outback Wilderness. Designed for quick and easy installation and removal. Consult vehicle owner's manual for total roof load limit.

- ✦ *Features large surface area to mount multiple accessories.*
- ✦ *Aerodynamic profile helps minimize wind noise.*
- ✦ *Suitable for use with roof top tents.*

SOA567X070 (Outback Wilderness only)

Thule® Cargo Carriers

Provide additional cargo-carrying capacity and feature dual-side opening for easier loading and unloading from either side of the vehicle. The low-profile, aerodynamic design provides increased garage access without sacrificing box capacity and the Quick-Grip™ mounting system allows for an easy, tool-free installation and removal.*



Thule® Cargo Carrier

- ✦ 13 cubic feet lockable storage capacity.
- ✦ Measures 65" L x 34.5" W x 16" H.

SOA567C022

Thule® Cargo Carrier – Extended

- ✦ 17 cubic feet lockable storage capacity.
- ✦ Measures 84" L x 34.5" W x 17" H.

SOA567C031



Subaru engineers work hand-in-hand with Thule® during the design and development of Genuine Subaru Lifestyle Accessories. A comprehensive series of tests are performed to ensure all racks and carriers comply with stringent Subaru requirements.

Thule® Heavy-Duty Roof Cargo Basket

Provides additional storage space with easy access to load and unload gear of all shapes and sizes.*

- ✦ *Low-profile design and tapered sidewalls.*
- ✦ *Custom fairing to help deflect wind.*
- ✦ *Includes black stretch net with hooks.*
- ✦ *Measures 50.25" L x 41" W x 6" H.*

S0A567C011



Thule® Kayak Carrier

J-style design cradles and supports one kayak up to 36" wide and up to 75 lbs. during transport.*

- ✦ *Steel design and adjustable padding for protection.*
- ✦ *Wide-mouth profile for easy loading and unloading.*
- ✦ *Folds down when not in use for increased overhead clearance and improved fuel economy.*
- ✦ *Includes straps and tie downs.*

S0A567K010



Thule® Paddleboard Carrier

Telescoping design provides a custom fit to transport boards up to 34" wide. Holds up to two boards.*

- ✦ Heavy-duty, steel-reinforced webbing.
- ✦ Improved locking mechanism for security.
- ✦ Soft, weather-resistant padding protects boards during transit.

SOA567P011



Thule® Ski and Snowboard Carrier

Securely holds up to six pairs of skis or four snowboards.*

- ✦ Ultra-soft rubber arms grip without scratching surfaces.
- ✦ Features 30" wide loading platform.
- ✦ Includes four locks to lock gear to the carrier and carrier to vehicle.

SOA567S011





Thule® Bike Carrier – Hitch Platform (2-bikes)

Designed to transport mountain or downhill bikes, ebikes, fat bikes, or bicycles with carbon frames. Rack tilts down for rear of vehicle access and folds up when not in use. Includes locks to secure bikes to the carrier and the carrier to the vehicle.

- ★ *Durable steel construction.*
- ★ *Designed to fit 1-1/4-inch receiver.*
- ★ *Fits most 20" to 29" wheels with tires up to 5" wide.*
- ★ *Requires Thule® 2-inch hitch adapter.*
- ★ *Two bike, 100 lbs. total weight capacity.*

SOA567B060

SOA567H011 (2" Adapter)

Requires Trailer Hitch.

To avoid blocking taillights, use only roof mounted bike carriers to transport bikes with solid disc wheels. Before installing this carrier, please check the laws of your state regarding license plate visibility.

Thule® Bike Carriers – Hitch Mounted

Designed to properly attach to the Genuine Subaru Trailer Hitch to securely transport bicycles. The anti-sway cages prevent bike-to-bike and bike-to-vehicle contact. Arms fold down when not in use and the rack pivots backwards for rear of vehicle access. Integrated locking cable and locking hitch pin lock the bikes to the carrier and carrier to the vehicle. Easy to handle, install and remove.

Requires Trailer Hitch.

To avoid blocking taillights, use roof mounted bike carriers to transport bikes with solid disc wheels. Before installing this carrier, please check the laws of your state regarding license plate visibility.

Thule® Bike Carrier – Hitch Mounted (2-bikes)

- ◆ *Lightweight, aluminum rack is nearly half the weight of most hitch racks.*
- ◆ *Requires Thule® 2-inch hitch adapter.*
- ◆ *Two bike, 70 lbs. total weight capacity.*



SOA567B042

SOA567H011 (2" Adapter)



Thule® Bike Carrier – Hitch Mounted (4-bikes)

- ◆ *Durable steel construction.*
- ◆ *Designed to attach to the 2-inch Genuine Subaru Trailer Hitch.*
- ◆ *Four bike, 150 lbs. total weight capacity.*



SOA567B051



Trailer Hitch

Subaru hitches are engineered and crash tested to meet the same rigorous safety standards as the rest of the Outback. Heavy-duty 2-inch receiver rated at 3,500 lbs. towing capacity, 350 lbs. tongue weight for the 2.4L Turbo XT and Outback Wilderness models, and 2,700 lbs. towing capacity, 270 lbs. tongue weight for the naturally aspirated 2.5L. Trailer hitch requires the hitch and harness for proper operation and safety compliance.

L101SAN000 (Trailer Hitch)

L101SAN200 (Ball Mount)

Hitch ball not included. Ball Mount sold separately. Trailer brakes may be required by your state for heavier loads. Consult owner's manual for more information. Trailer Hitch Fascia Panel required when installing the Trailer Hitch on the Outback Wilderness.

Trailer Hitch Fascia Panel

Designed with durable, weather- and fade-resistant construction, the integrated Trailer Hitch Fascia Panel is engineered to seamlessly blend in with the vehicle fascia design, providing a finished appearance when the Genuine Subaru Trailer Hitch is installed.

L101SAN620 (Outback Wilderness only)

Required when installing the Trailer Hitch on the Outback Wilderness.

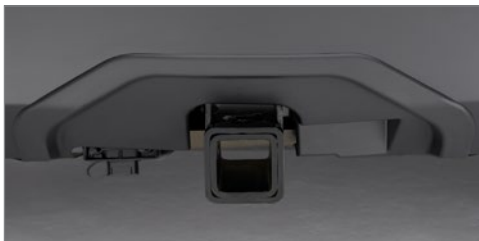

Trailer Hitch Cap

Designed to fit the Subaru Trailer Hitch, this cap is made from rubberized exterior grade plastic with a screen printed Subaru logo in UV-resistant polyurethane.

SOA342L172



Thule® Bike Carrier – Fork Mounted

Features a sliding rear wheel cradle to securely transport one bicycle. Includes one lock to securely lock the bike to the carrier and the carrier to the vehicle.*

- ◆ Fits most bikes with up to 2.6" wide tires.
- ◆ Corrosion-resistant, low-profile, lightweight aluminum tray.
- ◆ Ratcheting wheel strap secures the rear wheel.
- ◆ Integrated mounting clamps to easily install or switch between compatible vehicles.

SOA567B011



Thule® Bike Carrier – Roof Mounted

Features self-adjusting jaws that automatically wrap around the downtube for precise frame hold. Includes one lock to securely lock the bike to the carrier.*

- ◆ Fits most 20" to 29" wheel bikes with up to 2.6" wide tires.
- ◆ Adjustable mounting clamps to easily install or switch between compatible vehicles.

SOA567B020



Thule® Roof Top Tent

A modern shape and spacious interior transform your vehicle into a home away from home, providing more living space for you and for your gear. Features panoramic skylights and windows to help keep you cool and the tent well ventilated, and a dual-layer foam mattress for increased comfort.

- ✦ *2-3 person capacity: sleeps two adults and one child, or two adults comfortably.*
- ✦ *Lockable mounting brackets secure the tent to the Thule® Crossbar Set – Aero Extended.*
- ✦ *Removable rain cover with three modes of protection – heavy rain, rain protection with visibility through windows and skylights, and ready-to-deploy mode.*
- ✦ *Six dual-zippered panels for the door, window, and four skylights feature a bug screen and water-resistant polyester panel for privacy.*
- ✦ *Zippered travel cover protects the tent from the elements when the tent is stowed on top of the vehicle.*
- ✦ *Telescoping aluminum ladder allows easy access to the roof top tent and functions as a critical support to stabilize the weight of the tent and its occupants; top ladder rungs must be compressed at the top for stability.*
- ✦ *Suitable for use on Subaru vehicles equipped with factory raised roof rails and adequate roof capacity. Consult vehicle owner's manual for total roof load limit.*
- ✦ *Quick and easy deployment in three minutes or less: unzip the travel cover, unfold the base and secure the ladder properly to begin your camping adventure!*

S0A567C100 (Outback Wilderness only)

Requires Thule® Crossbar Set – Aero Extended.

- ✦ *Open dimensions: 95" x 56" x 44"*
- ✦ *Closed dimensions: 49" x 56" x 11"*
- ✦ *Sleeping footprint: 95" x 51"*
- ✦ *Peak internal height: 40.2"*
- ✦ *Weight of tent: 128 lbs.*



Thule® Roof Top Tent shown on Subaru Crosstrek.



Thule® Awning – Roof Mounted shown on Subaru Forester Wilderness.

Thule® Awning – Roof Mounted

Seamlessly integrates with your Subaru to provide shelter from the sun and rain. The awning features high strength fabric with an exclusive system for perfect canopy tension, and integrated telescopic support legs to help quickly setup and adjust to the correct height. When it's time to drive, easily stow and protect everything in a sleek, durable and lightweight aluminum case.

- ✦ *Integrated legs and tension arms allow for simple, one person setup.*
- ✦ *6.2 ft. in length and projects 8 ft. when fully extended.*
- ✦ *Suitable for use on vehicles with a crossbar set.*
- ✦ *Includes locking adapter kit for mounting to the crossbars and stakes to secure the legs to the ground.*
- ✦ *When used on a hard surface, weights are recommended to anchor and stabilize the legs.*
- ✦ *Can be used in conjunction with the Thule® Roof Top Tent or other Genuine Subaru Lifestyle roof top accessories.*

SOA567C200

Explore with ease.

It's safe and spacious, offering comfort for you and every passenger, with plenty of room for all your gear. Whether a long-distance adventure or a short trip around town, with Genuine Subaru Accessories, every journey will become a first-class travel experience.



COMFORT AND CONVENIENCE



Cargo Net

Neatly holds cargo and prevents it from sliding while the vehicle is in motion. The Cargo Net can be used in two ways: anchor it to the sides of the cargo area to help prevent shifting from front to back or lay it across the floor to help keep things from rolling around.

F551SAN000



Cargo Separator

Serves as a partition between 2nd row seating and cargo area to help provide additional passenger safety when transporting cargo in the rear of the vehicle.

- ◆ *Mesh design does not obstruct rear visibility.*
- ◆ *Designed with open areas on both sides for proper airbag deployment.*

F551SAN400

Not for use with child seats requiring tether straps. Cannot be used with installed Cargo Cover. May be used separately. This product is not suitable for use with pets.



Auto-Dimming Mirror with Compass and HomeLink®

Detects glare and darkens automatically to protect vision.

- ◆ *Features an 8-point digital compass.*
- ◆ *Three backlit HomeLink® buttons can be programmed to operate most garage doors, security gates, home lighting, and more.*
- ◆ *Provides status of garage door if programmed to a compatible opener with two-way communication.*

H501SAN000 (Base and Premium trims only)



Sunshade – 2nd Row

Keep your rear passengers comfortable with the 2nd Row Sunshade. When in use, these sunshades dull sun glare and reduce temperatures, as well as provide UV-A/B protection. Custom designed to function with all safety features.

F501SAN000

Not for use when the windows are fully open while the vehicle is in motion.



Sunshade – Windshield

The foldable Sunshade offers a triple layer of protection to help reduce vehicle temperature up to 40 degrees. The Sunshade is custom-cut to fit properly, and includes a handy storage bag.

SOA3991722



Phone Holder – Cup Holder Mounted

Designed to securely hold your mobile phone in either portrait or landscape position and can be tilted at a variety of angles. The phone holder includes a tray to hold small personal belongings and is easily installed by inserting into the center console cup holder.

SOA800P000



Ash Tray

Fits conveniently in the center console cup holder. Easily removed to empty contents.

92172AG040

Requires Ash Tray Holder.



Ash Tray Holder

Helps to give the ash tray accessory a snug fit in the center console cup holder.

F6010AG010



Moonroof Air Deflector

Helps reduce wind noise and sun glare.

F541SAN000



Cargo Organizer

Conveniently transport your outdoor gear or up to four grocery bags neatly in the back. Quickly collapses for easy storage when not in use.

SOA567T100



Genuine Subaru Accessories are designed using original factory vehicle CAD data for a precise fit compared to "one size fits all" aftermarket additions.

Remote Engine Starter

Allows vehicle to be started with the push of a button. The start/stop button blinks to confirm the engine has been started. Push Start works in conjunction with the Keyless Access and Start system and is an alternative to STARLINK® Safety Plus and Security Plus Package enrollment.

- ◆ Adjusts vehicle interior temperature for comfort upon entry.
- ◆ Starts vehicle up to 400 feet away depending on obstructions.



H001SAN101 (Key Start)

H001SAN001 (Push Start)



Cargo Cover

Keep items in the back out of sight with this fully retractable, maximum coverage compartment cover.

65550AN00BVH (Base trim only)

Cargo Cover can be stored in rear compartment when not in use.

Paws-itive travel experiences.

Prepare your pets for every journey you take together and help keep them safe and comfortable. With Genuine Subaru Pet-friendly Accessories, even your furry family will enjoy the adventures ahead.

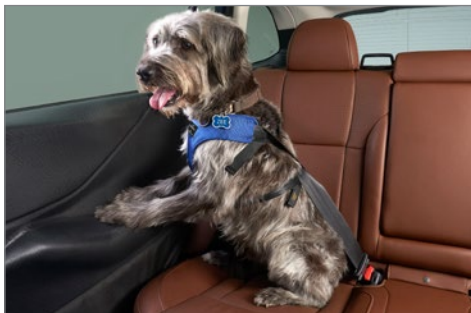

Pet Rear Door Protector

Helps protect your door panel from scratches, nail punctures, scuffs, dirt and dog drool. Comes in a set of two.

- ✦ *Lightweight, durable design to seamlessly fit the contours of the door.*
- ✦ *Heavy-duty polyester extends protection to the entire door panel.*
- ✦ *Features three clips that insert between the window and door panel for easy installation and removal.*
- ✦ *Folds in half to store when not in use.*

SOA567R000

Not intended for use with human passengers in the back seat.
Not recommended for use with aftermarket rear window tint.

Collapsible Pet Kennel

Portable, compact, lightweight and constructed of durable, black polyester fabric and a steel tube frame. Designed with three large integrated zippered openings for easy pet access. Includes carrying handle to easily transport when not in use and two pockets to carry your pet's personal cargo. Manufactured by Thule®.

- ✦ *Designed for travel and everyday transport of your pets.*
- ✦ *Easy-to-use alternative to cumbersome metal carriers.*
- ✦ *Secures in the cargo area with four adjustable straps and carabiner hooks.*

SOA567P100 (Medium: 32" L x 23" W x 23" H)
SOA567P200 (Large: 36" L x 25" W x 25" H)

The Collapsible Pet Kennel, manufactured by Thule®, is backed by a 2-year warranty through Thule®. Please visit <https://www.thule.com/en-us/about-thule/warranty> for details.



Pet Carrier and Mobile Pet Bed

Multi-functional, ultra-plush pet bed provides comfort for your pet and helps make travel less stressful. Features zipper pulls to remove upper mesh dome, padded carry handle and adjustable shoulder strap. Manufactured by Sleepypod® and uniquely designed in Subaru blue.



- ✦ *Doubles as a carrier and car seat to transport your small dog or cat in comfort and safety.*
- ✦ *Crash-tested and certified by the Center for Pet Safety.*
- ✦ *Designed with Velcro® positioning points to secure seatbelt straps when used as a car seat.*
- ✦ *Luggage-grade exterior easily wiped clean.*
- ✦ *Removable plush bedding is machine-washable.*

SOA854S100

Suitable for pets weighing 15 pounds and under. Not suitable for use during air travel.



Pet Harness

Buckle up your dog for safety before you begin your road trip together. Infinity Loop webbing design, padded vest, seatbelt grade straps and stress-tested buckles work together to distribute and reduce damaging forces in the event of a car collision. Manufactured by Sleepypod® in signature Subaru blue. Refer to the sizing guide to determine the correct size for your dog.

- ✦ *Crash-tested at child safety seat standards and certified by the Center for Pet Safety for dogs 18-90 lbs.*
- ✦ *Double "D" ring connection design to affix a leash.*
- ✦ *Reflective strips and logo for improved visibility at night.*

- SOA854H000 (Small: 16.5" - 22")**
- SOA854H010 (Medium: 22.5" - 28")**
- SOA854H020 (Large: 28.5" - 34")**
- SOA854H030 (X-Large: 34.5" - 40")**





Pet-friendly Padded Cargo Liner

Provides a comfortable resting area for your pet while protecting the cargo area and seatbacks from pet hair, nail scratches, accidents and spills.

- ✦ Features thick padding and durable polyester shell.
- ✦ Includes foldout bumper protector for added protection.
- ✦ Integrated zipper allows for 60/40 seats to be up or down when in use.
- ✦ Easy installation: latches attach to the lower cargo mounting loops and rear child seat tether points.
- ✦ Adjustable straps affix to headrests and Velcro® mounting straps attach at various locations for increased stability.
- ✦ LATCH-accessible, machine-washable, easy to vacuum or wipe clean.

J501SAN270



Organizer and Pet Rear Seat Extender

Increase the back seat resting area for your dog to stretch out comfortably during long trips, while providing storage space for pet gear and other personal items.

- ✦ Conforms to the shape of the rear seat to match seat height and minimize the gap between the seat and the extender.
- ✦ Helps keep your pet calm and comfortable by filling the gap between front and rear seat.
- ✦ Suitable for dogs up to 200 lbs.
- ✦ Includes dividers to keep personal items well organized and provide a sturdy structure to support your pet's weight.
- ✦ Easy to clean and folds flat for storage when not in use.
- ✦ Two required to cover the driver and passenger side back seat areas.

J201SSL000





Pet-friendly Padded Seat Protector

Protects the back seat from muddy paws and pet hair while your pet travels in padded comfort. Designed without buckles or straps, installation and removal is quick and easy with removal and reinstallation of the headrests and repositioning of the seatbelt through a Velcro® opening in the protector.

- ✦ Heavy-duty quilted seat pad and tailored seatback for maximum coverage.
- ✦ LATCH-accessible, machine-washable and water-resistant.
- ✦ Suitable for use with child car seats and rear passengers.

F411SAN020

60/40 seat functionality compromised when in use.



Seat Cover – Rear

Tailored to provide a snug fit to help keep your back seat tidy. Install with integrated straps and buckles. Made with a polyester front and polyurethane coated back, the cover is great for pets, kids and life on the go.

- ✦ Includes full protection to the rear headrests.
- ✦ LATCH-accessible, machine-washable and water-resistant.

F411SAN060

60/40 seat functionality is preserved when in use.



Console Lid Protector

Protects the center console lid surface from nail scratches and puncture holes, and provides a comfortable armrest for front seat passengers.

- ✦ Multi-layered padded interior for increased comfort.
- ✦ Secured with two durable integrated elastic straps.
- ✦ Non-slip bottom helps keep it in place.

J201SAN601



Pet Ramp

Provides easy access for pets to enter and exit the vehicle. Aluminum and plastic construction with rubberized feet to avoid shifting when in use.

- ✦ Especially suited for senior dogs and those with mobility issues.
- ✦ Non-slip ramp and high-grip ridged surface for safer footing in most weather conditions.
- ✦ Lightweight, telescoping design folds with ease to store when not in use.
- ✦ Supports pets up to 220 lbs.

SOA932P100

Use only for pets to enter and exit the cargo area. Not suitable for rear seat entry and exit.



Rear Bumper Protector Mat

Helps protect top surface of rear bumper when your pets are entering and exiting the vehicle.

E101EAJ501

When not in use, folds flat on cargo floor or under Cargo Tray.



License Plate Frames – Pet Lover

At Subaru, pets are part of the family. Share your love for your furry, scaly or feathered friends with our Pet Lover license plate frame. Subaru Pet Lover frames are manufactured from heavy-gauge 304-stainless steel that will not rust or corrode, and feature a 1/2" frame width around the top and sides and 1-1/8" width bottom.

- SOA342L165 (Matte Black)**
- SOA342L166 (Stainless Steel)**



Pet Travel Bowl

Travel with your pet's food and water in one convenient, portable container. Freeze water in the base to keep water cool and wet food fresh. Manufactured by Sleepypod® and designed in distinctive Subaru blue.

- ✦ Lid doubles as a second bowl.
- ✦ Textured base helps resist spilling or tipping.
- ✦ Constructed of FDA food grade silicone, dishwasher and microwave safe and BPA free.

- SOA854B001 (Small)**
- SOA854B002 (Medium)**

Adventure looks good.

Your Subaru Outback always looks prepared for your next adventure and is engineered to take you anywhere. Add a personal touch with Genuine Subaru Accessories to show the world what you're really made of.



Exterior Graphics – Side and Side Rear Window (Anodized Copper)

Anodized Copper graphics added to the lower door panels and side rear windows perfectly match the bold accents of the Outback Wilderness. Exterior Graphics are constructed of durable PVC film.

J121SAN200 (Side)

J121SAN500 (Side Rear Window)

Outback Wilderness only.
Exterior Graphics – Side cannot be installed with Door Cladding.





LED Upgrade

Enhance the illumination of your standard interior visor lights with brighter, whiter and crisper LED lighting.

- ◆ *Developed to rigorous Subaru standards for seamless operation and uninterrupted functionality.*
- ◆ *Tested to help ensure the safety of your vehicle's electrical infrastructure.*
- ◆ *Evaluated and carefully color-tuned for flattering lighting.*

H461SAN030

Key Chain – Carbon Fiber

Carbon fiber composite and stainless steel key chain with leather strap and universal split ring.

SOA342L155



Door Projector Lights

Adds to the vehicle's styling by projecting a silhouette of the Outback vehicle onto the ground when the front doors are open.

H4610AN100

Key Chain – Stainless Steel

Made from 1/8-inch thick 304-stainless steel, with a brushed finish and permanent black laser-etched graphics.

SOA342L162



Exterior Graphics – Side (Sport Orange)

Add a stylish touch to your Outback with graphics for the lower door panels. The Exterior Graphics Kit is constructed of durable PVC film and finished in Sport Orange.

J121SAN100

Cannot be installed with Door Cladding.
Not applicable to Outback Wilderness.



Footwell Illumination Kit

Illuminate dark corners of the front floor area and upgrade the interior ambiance with a gentle white glow.

- ★ LED lights install securely into designated, prearranged locations.
- ★ Brightens and dims in conjunction with vehicle interior lighting.
- ★ Integrated into vehicle's electrical infrastructure for uninterrupted functionality.

H461SAN003



Interior Trim Kit – Woodgrain

Upgrade the appearance of the Outback interior with a woodgrain accent for your dash.

J1310AN000

Not applicable to Outback Wilderness.





Bumper Under Guard – Front

Designed to securely fit and conform to the lower front bumper of the Outback. Adds a rugged styling appearance. Requires Clip: 909140007 (1 each) and Clip: 909140063 (2 each) for installation.

57734AN04A
(Base and Premium trims only)



Bumper Under Guard – Rear

Completes the rugged look of the Outback.

57734AN11A
(Base and Premium trims only)

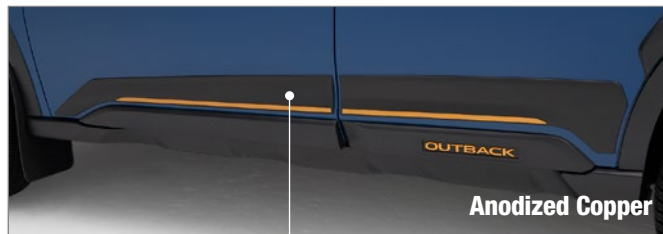

Rear Gate Trim – Chrome

Enhance the appearance of your rear lift gate with chrome trim.

J3110AN020
Not applicable to Outback Wilderness or Onyx Edition.

Door Cladding

An upward extension of the lower door trim, designed to enhance the rugged exterior appearance of the vehicle.

- ✦ *Engineered to seamlessly conform to the vehicle door.*
- ✦ *Evaluated for fade, scratch and crack resistance.*
- ✦ *Designed to maintain aerodynamic performance.*

J101SAN901 (Black)
J101SAN930 (Sport Orange Accent)
J101SAN960 (Anodized Copper Accent)

Cannot be installed with Exterior Graphics – Side.
Sport Orange not applicable to Outback Wilderness.
Anodized Copper applicable to Outback Wilderness only.

Genuine Subaru License Plate Frames are manufactured from superior quality 304-stainless steel that will not rust or corrode and feature a 2-hole design. Kits include matching hardware fastener caps for a seamless appearance.



License Plate Frames – Slim Line

Feature a 1/2" frame width around all four sides.

SOA342L104 (Stainless Steel)

SOA342L105 (Matte Black)



License Plate Frames – Slim Line (Subaru)

Frames display the Subaru logo and feature a 1/2" frame width around all four sides.

SOA342L152 (Stainless Steel)

SOA342L153 (Matte Black)



License Plate Frames – Adventure Seeker

You pick the adventure and your Subaru will get you there. Adventure Seeker frames are made for the explorer. Feature a 1/2" frame width around the top and sides and 1-1/8" width bottom.

SOA342L163 (Matte Black)

SOA342L164 (Stainless Steel)



License Plate Frames (Subaru)

Frames display the Subaru logo in UV-resistant polyurethane coating and feature a 1/2" frame width around the top and sides and 1-1/8" width bottom.

SOA342L127 (Stainless Steel)

SOA342L167 (Matte Black)



License Plate Mounting Bracket – Universal Fit

With four holes across the top, the license plate mounting bracket can be installed without drilling on models with existing bumper holes. Stainless steel with black powder coated finish. Includes mounting hardware for easy installation.

SOA342L171

Outback Wilderness only.



License Plate Frame (Slim Line) and License Plate Mounting Bracket – Universal Fit

This set includes a slim line license plate frame and front license plate frame mounting bracket.

SOA342L169 (Stainless Steel)

SOA342L170 (Matte Black)

Outback Wilderness only.

Subaru Oil Cap

Replacement oil cap is machined from billet aluminum, anodized in blue and laser-etched with the Subaru logo.

SOA3881310



Valve Stem Caps

Add a finishing touch to your Subaru. These caps feature the Subaru star cluster and an "O" ring seal to help keep the valve orifices clean.

SOA342L137 (Chrome)

SOA342L168 (Black)





Subaru of America reserves the right to change or withdraw accessories at any time without prior notice and without incurring the obligation to make changes to any accessories previously sold. All images are representative.

Subaru, Outback and STARLINK are registered trademarks. Android Auto is a trademark of Google LLC. Apple, CarPlay and Lightning are registered trademarks of Apple, Inc. HomeLink is a trademark of Gentex Corporation. Qualcomm, Quick Charge and Qualcomm branded products are products of Qualcomm Technologies, Inc. and/or its subsidiaries. Samsung is a registered trademark of Samsung Electronics Co., Ltd. Sleepypod is a registered trademark. The Center for Pet Safety (CPS) is a 501(c)(3) non-profit research and advocacy organization dedicated to consumer and companion animal safety. Thule and Quick-Grip are registered trademarks of the Thule Group. Velcro is a registered trademark of Velcro IP Holding LLC.

*Roof accessories require Crossbar Set. Consult vehicle owner's manual for total roof load limit.

©2024 Subaru of America, Inc.

Printed in U.S.A.

MSA6A2407

