

MACCK
MACCK
MACCK
MACCK®

Highway



Table of Contents

Overview	04
Powertrain	10
Mack Pinnacle™	14
Mack Anthem®	16
HE+ Package	20
Command Steer	22
Cab Comfort	28
Sleeper Cabins	34
Options	38
Integrated Uptime	40
Customer Support	42
Financial & Maintenance Services	44

Welcome to the
new era of efficiency
and performance.



The future of highway hauling.

Mack highway trucks carry more than cargo. They move your business forward. That's why we've armed our highway trucks with every advantage possible. Reliable, fuel efficient and driver friendly, the Mack Anthem and Mack Pinnacle tractors are built for your business and designed for the driver.

Connected Uptime

Equipped with Mack's productivity and uptime technologies, our highway trucks stay on the road and out of the shop.

Driver Focused

Redesigned interiors are built around the way work gets done on the road, keeping drivers more comfortable and productive than ever.

Mack Tough

The industry has trusted their toughest jobs to Mack for generations. Built in America from light, yet durable materials, our highway trucks stand up to the rigors of the road.

Lightweight and Efficient

Mack's fully integrated powertrain combines fuel economy and lightweight power to deliver highway trucks that drive down costs.

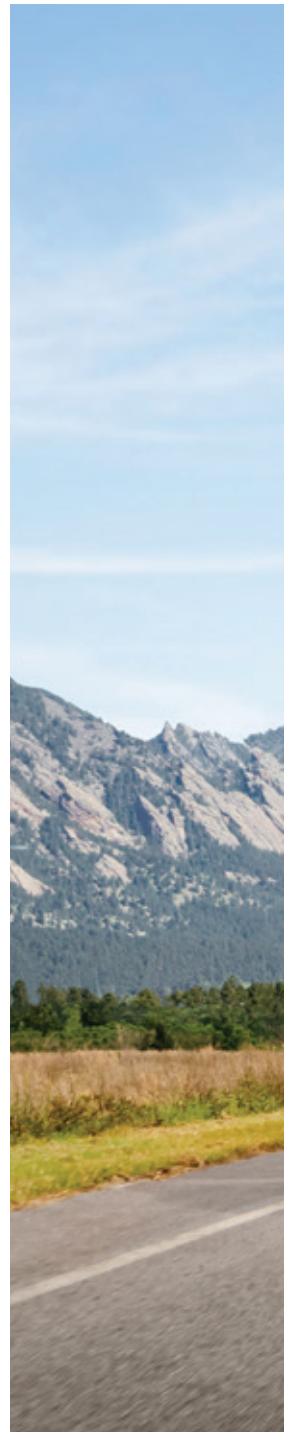



Meet the heroes of the highway.



Mack Anthem 48-Inch Sleeper

Next-generation efficiency.

Mack Anthem 70-Inch Stand Up Sleeper

Designed for the long haul.

Mack Pinnacle 70-Inch Sleeper

Legendary toughness.



Ready for any road.

Whether you're covering 10 miles or 10,000, you can count on Mack highway trucks to get you there. No matter the job, the Mack Anthem and Mack Pinnacle deliver the strength, comfort and efficiency you need to tackle whatever the road brings.



Long Haul

The ergonomic driver environment and spacious, stand up sleeper in Mack Anthem keeps drivers comfortable, mile after mile.



Regional Haul

Clean wheel cuts of the Mack Anthem provide easy maneuverability the road demands.



Flatbed

Pinnacle has the power and performance to handle the heaviest hauls.

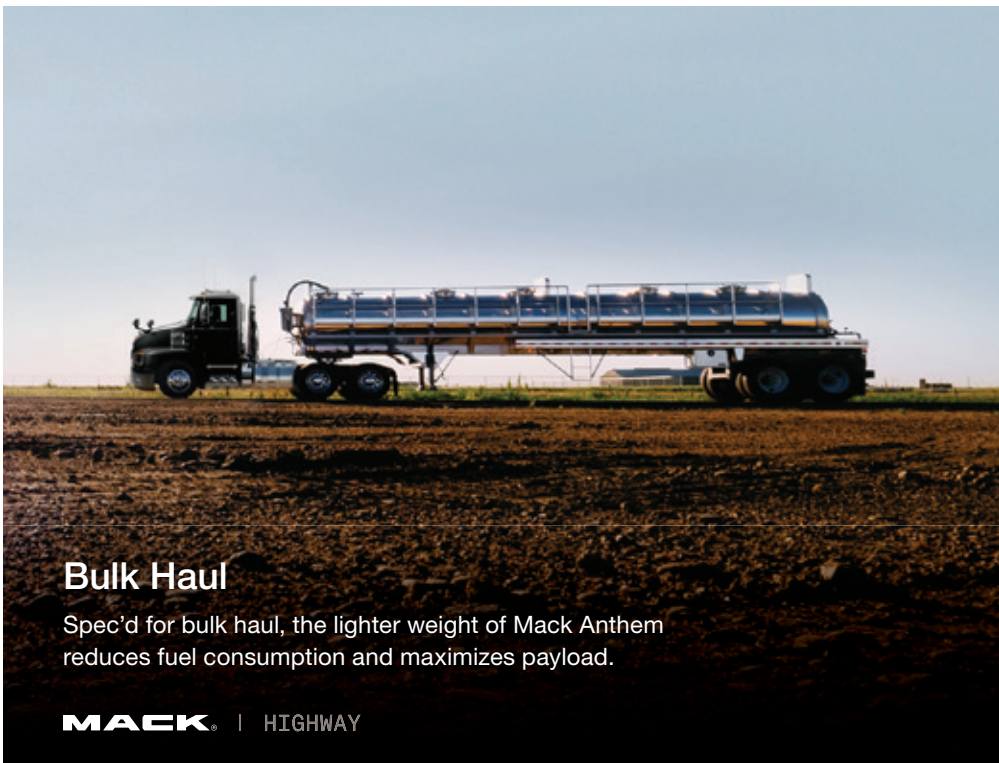

Bulk Haul

Spec'd for bulk haul, the lighter weight of Mack Anthem reduces fuel consumption and maximizes payload.

MACK | HIGHWAY

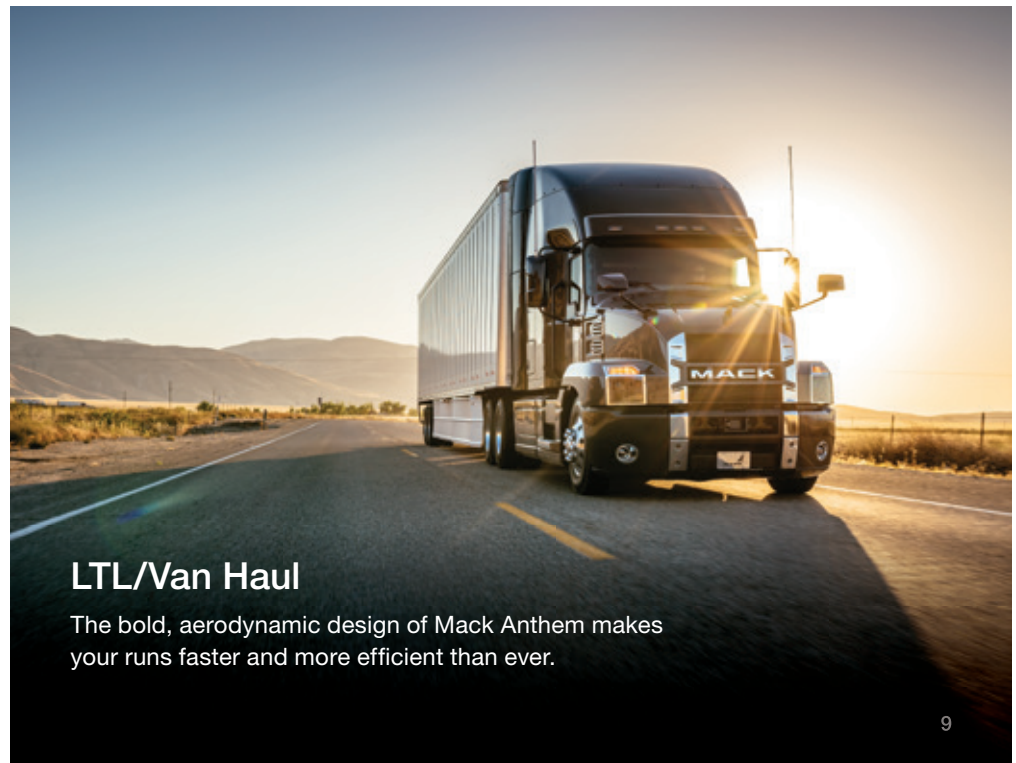

LTL/Van Haul

The bold, aerodynamic design of Mack Anthem makes your runs faster and more efficient than ever.

Powered by Mack's integrated powertrain.

Engineered for efficiency and performance, and proudly assembled in Mack's Hagerstown, Maryland facility, our integrated powertrain is the toughest in the game. Bar none.

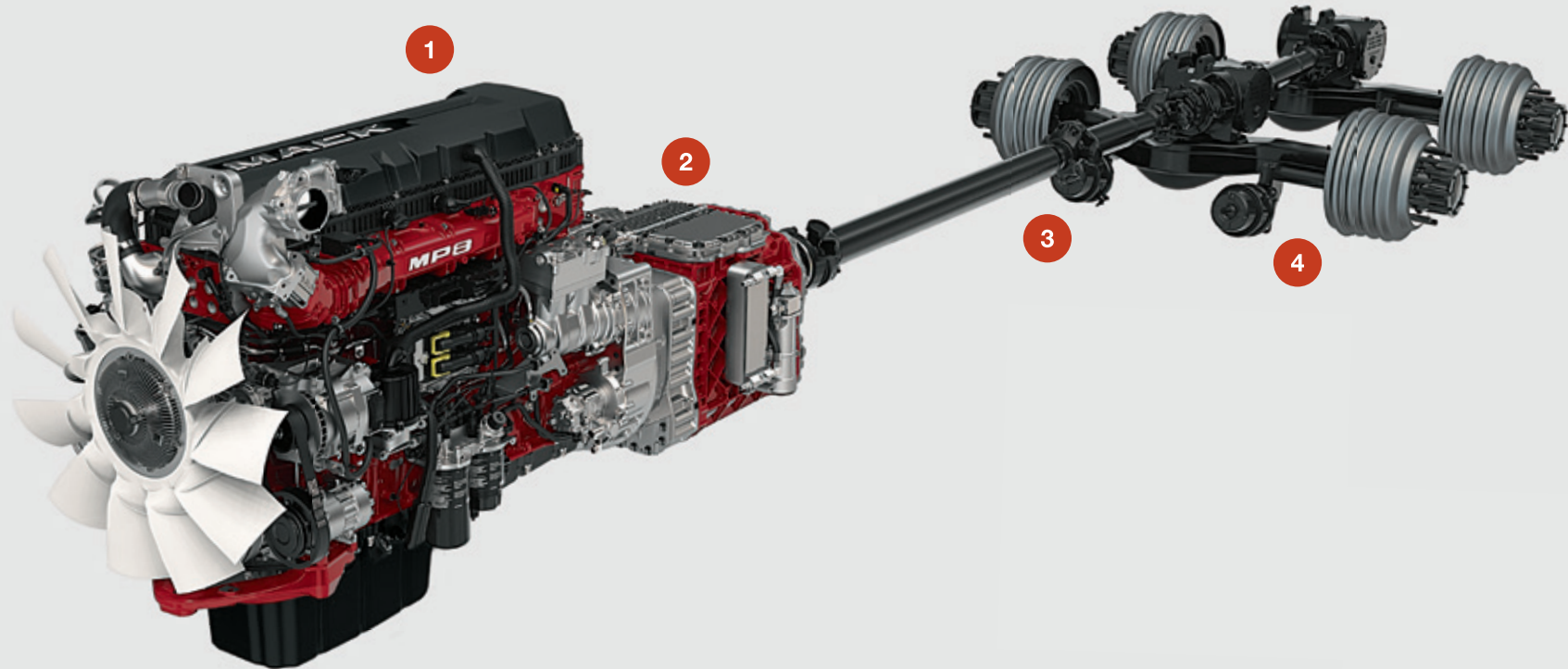

1. MP® Engines

With superior horsepower, torque and fuel economy, Mack's MP engines conquer the highway, mile after mile.

2. Mack Transmissions

Mack transmissions are designed to reduce driver fatigue, maximize uptime and perform in the most demanding conditions.

3. Mack Axles

Featuring multiple options including 4x2, 6x2p, 6x4 and 8x4 configurations, our axles outperform everywhere—from cross-country long hauls to on-road/ off-road applications

4. Mack Suspensions

Engineered to be lighter and stronger, for enhanced reliability and outstanding performance.

MP8



MP®8HE Engine

Featuring the latest innovations in Energy Recovery Technology (ERT), the Mack MP®8HE engine improves engine performance more efficiently than ever before.

ISX12N

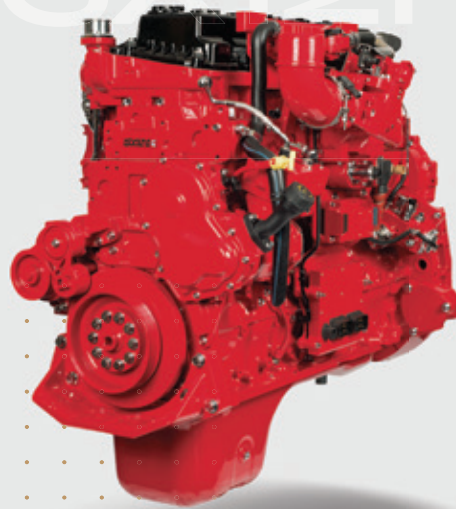

Natural Gas Engine

The Cummins® Westport ISX12N brings a natural gas option for heavy-duty vehicles. It drives NOx emissions to near zero and brings up to 400 horsepower to demanding highway jobs. Mack offers factory-installed CNG tanks with an LNG option.

Energy Recovery Technology

The MP®8HE's ERT feature converts exhaust emissions to mechanical energy and delivers it back to the crankshaft as torque. This enables the engine to operate at 1,000–1,100 RPM, saving fuel without sacrificing performance.

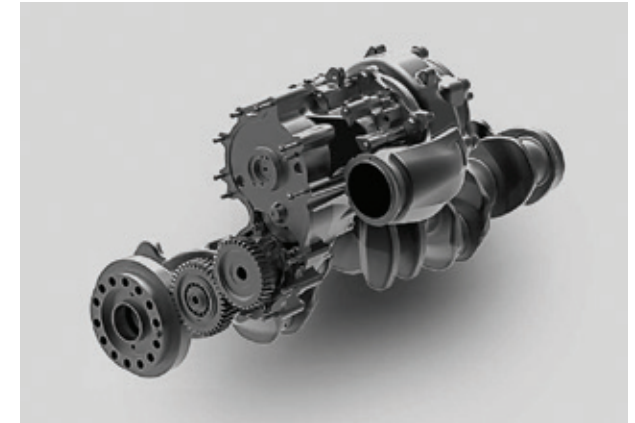

Wave Piston Design

By adding small waves to the piston bowl, the engine can burn fuel more efficiently for reduced fuel consumption and lower emissions.



*m*DRIVE™

Mack's industry-leading automated manual transmission expands your driver base, reduces costs and delivers the smoothest shifting around.

Smarter Hauling

*m*DRIVE continuously monitors changes in grade, acceleration, vehicle weight and more to optimize fuel economy.

Minimal Service

Proven technology and superior design mean *m*DRIVE requires minimal service, significantly reducing maintenance costs and downtime.

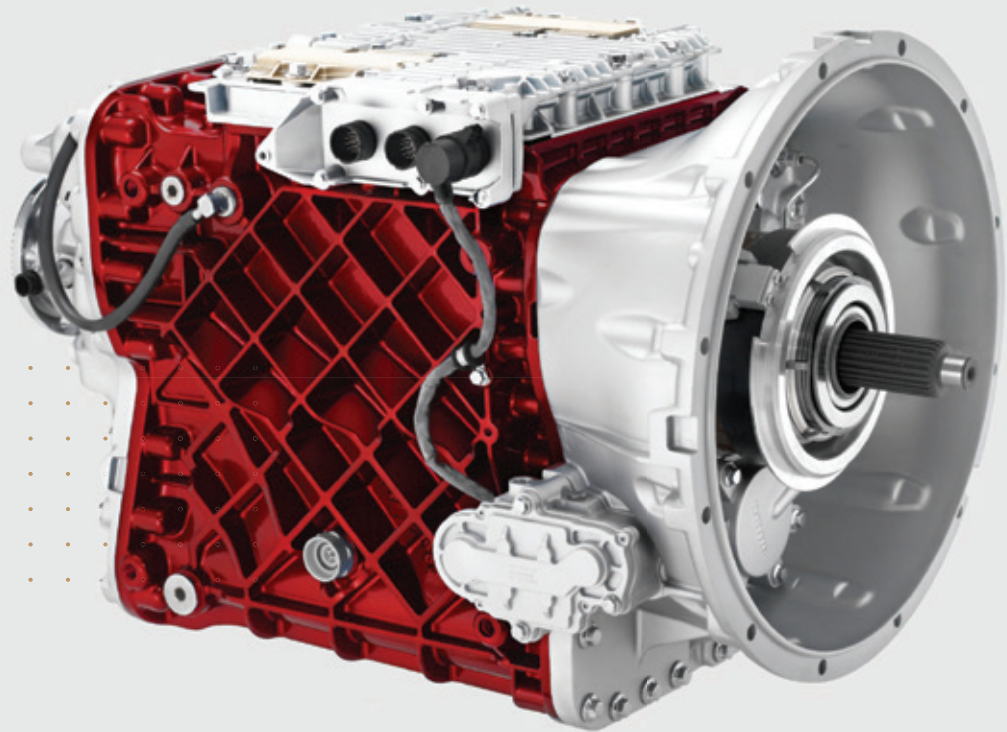



Oversized Buttons

The manual shift buttons also allow experienced driver's to have control of shifting for precise performance in all conditions.

Pinnacle

Pinnacle is designed with the comfort drivers need and the durability the road demands. Whether the haul is off-road or cross-country, Pinnacle is purpose-built to keep drivers comfortable and driving strong.

Durable Components

Reinforced and redesigned with new materials to be tougher than ever.

Axle-Forward Configuration

Forward axle position spreads the load to maximize your payload.

Advantage™ Chassis

Advantage Chassis frame rails support heavy loads, even on challenging terrain. And Pinnacle's spread frame rails place the engine and transmission lower in the chassis, improving stability with a lower center of gravity.

Highly Customizable

No matter your haul, Mack makes it easy to optimize your Pinnacle for the job.

Impressive Ground Clearance

The axle-forward position provides better clearance for when the Pinnacle needs to go off-highway and over bumpy terrain.

Cab Configurations

In Day Cab or Sleeper, the Pinnacle has the comfort and strength to keep drivers going strong until the job is done.

Cab Configurations



70-Inch Stand Up Sleeper

With full-height roof fairing



70-Inch Stand Up Sleeper

Without roof fairing



48-Inch Sleeper

With flat roof



48-Inch Flat Top Sleeper

With flat roof



Day Cab

Without roof fairing

Anthem

We took more than a century of experience building America and put it to work tackling the challenges of our industry. The result? A truck that will make you rethink what's possible on the highway. Boldly designed and engineered tough, Anthem is ready for whatever the road demands.

Built for Your Business

Efficient in every sense of the word, Anthem saves on fuel and reduces maintenance costs while maximizing uptime—and your bottom line.

Command the Road

The intuitive instrument panel and steering wheel of Anthem give drivers total confidence and control in the cockpit.

Designed for the Driver

The cab design and driver environment of Anthem are built around the way work gets done on the road, keeping drivers comfortable, safe and focused all day long.

Comfort for the Long Haul

A spacious interior and American craftsmanship give drivers the comfort they need to feel at home.

Utility From Top to Bottom

Configure the best-in-class storage in Anthem for as much or as little as you need to store.

Cab Configurations



70-Inch Stand Up Sleeper

With full-height roof fairing



70-Inch Stand Up Sleeper

Without roof fairing



48-Inch Flat Top Sleeper

With full-height roof fairing



48-Inch Flat Top Sleeper

With flat roof



Day Cab

With roof fairing



Day Cab

Without roof fairing

Aerodynamic never looked so Mack.

Anthem challenges the expectations of aerodynamic design with a bold look that dramatically improves efficiency up to 3%*.

Roof Fairings with Adjustable Trim Tab

Improves airflow from the cab to the trailer (70-inch Stand Up Sleeper only).

Hood Mirrors

Compared to tripod designs, our single support decreases wind resistance and folds on impact to prevent damage.

Hood & Fenders

Hood slope and fender design direct air over and around the trailer.

Covered Tow Loops

Cuts down on wind resistance to create a clean, polished look.

Air Dam

Shuttles air beneath the vehicle for less turbulence.

Close-Out Flange

Prevents airflow between hood and bumper by moving air around the cab.

Cab & Sleeper Side Fairings

Streamlined design improves performance by reducing drag around the cab.

Chassis Fairings

Creates a clean aerodynamic flow to push air around your chassis.

Drive Axle Fairings

Eliminates drag beneath the chassis to streamline performance.

*Compared to similar Mack Anthem® without HE engine and HE+ features.

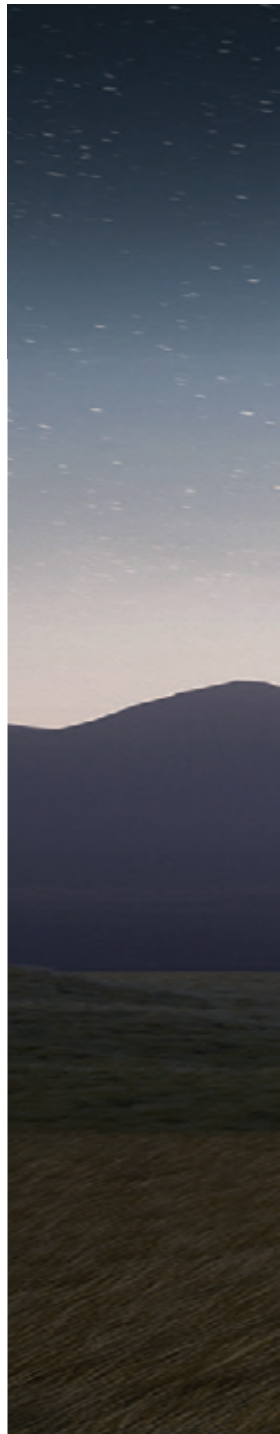

By displacing air to the sides, as well as over the hood and roof, Anthem cuts wind resistance and improves fuel economy. These aerodynamic fairings are at the core of the Mack HE+ Package, which arms an Anthem with the ultimate in fuel-efficient features.



The ultimate in fuel efficiency.

The HE+ Package combines an MP[®]8HE engine with distinctive aerodynamic and fuel economy features, like roof fairings and a sloped hood, to minimize drag, maximize profit and increase fuel efficiency up to 13.5%*.

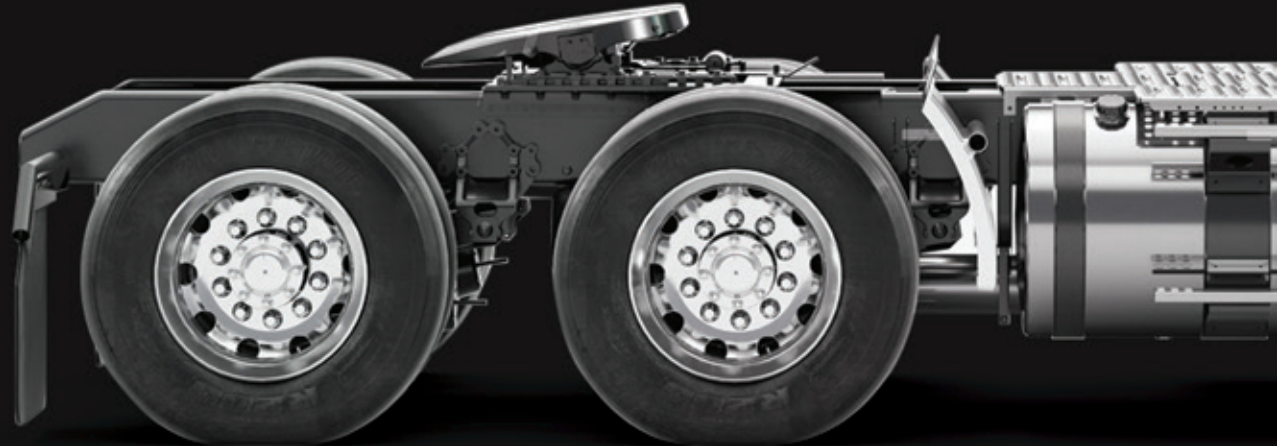



HE+ Package Fuel Savings

Outfit your Anthem with the ultimate in fuel-efficient features.

3% from enhanced aerodynamics
+ 9.5% from MP[®]8HE engine upgrade
1% from *mDRIVE*'s Predictive Cruise

= 13.5% Fuel Economy Improvement*

Save up to

2,700

Gallons
per year

That's nearly

\$10,800

Savings
per year**

*Compared to similar Mack Anthem[®] without HE engine and HE+ features.
**Using 20,000 gallons of fuel with an average fuel price of \$4.00 per gallon.

Drive productivity on every haul.

Mack Command Steer

Command Steer on the Mack Anthem combines world-class ergonomics and electronic-assist technology to deliver next-level handling and stability. Less strain on the driver, more productivity for your business.





The difference is in the drive.

By reducing driver effort up to 85%, Command Steer can cut muscular strain by up to 30% to reduce the risk of long-term injury.

Steering Wheel Return-To-Zero

During parking, reversing and driving, the steering wheel automatically returns to zero, saving drivers from wear-related injuries.

Improved Directional Stability

Drivers no longer need to compensate for drifting caused by gusts of wind or banked roads while driving at highway speeds. The result is a steadier and more comfortable ride.

Feather-Light Steering At Low Speeds

By adding force to the power steering mechanism, trucks adapt to each situation. At low speed, steering is nearly effortless.

Smooths Rough Roads

Command Steer automatically detects and compensates for rough roads and job sites to help drivers keep a straight course and eliminate the need for constant driver correction.

Split Friction Stability

When steering and/or braking on surfaces with different friction, Command Steer improves stability and keeps the steering wheel straight and steady to reduce unwanted steering changes.

Reduces Deviations

Command Steer monitors road variations at nearly 2,000 times per second to help maintain directional stability on rough roads and in high winds for a more comfortable ride on every road.



How It Works

An electric motor is connected to the hydro-mechanical steering gear to provide additional torque. The motor is controlled through an ECU and receives signals from vehicle sensors while dampening steering impacts from the ground, helping the driver maintain the desired control.



Built to last.



Anthem drives down operating costs with durability that stands up to the rigors of the road and keeps you out of the shop.

Breakaway Hood Mirrors

The mounts are spring-loaded to rotate when hit, preventing damage to the hood and lowering parts and repair costs.

Breakaway Side Mirrors

Strong hinges with zero plastic, tougher materials and spring-loaded mounts help keep maintenance costs down.

Durable Components

From bolts to latches, all Anthem components are made from tough, long-lasting materials.

Heated LED Lights

LED headlights are 66% brighter, last longer, use less energy and provide better visibility.

Smart Serviceability

The tilt-assist hood and functional, modular design allow service professionals to access, repair and replace components more quickly.

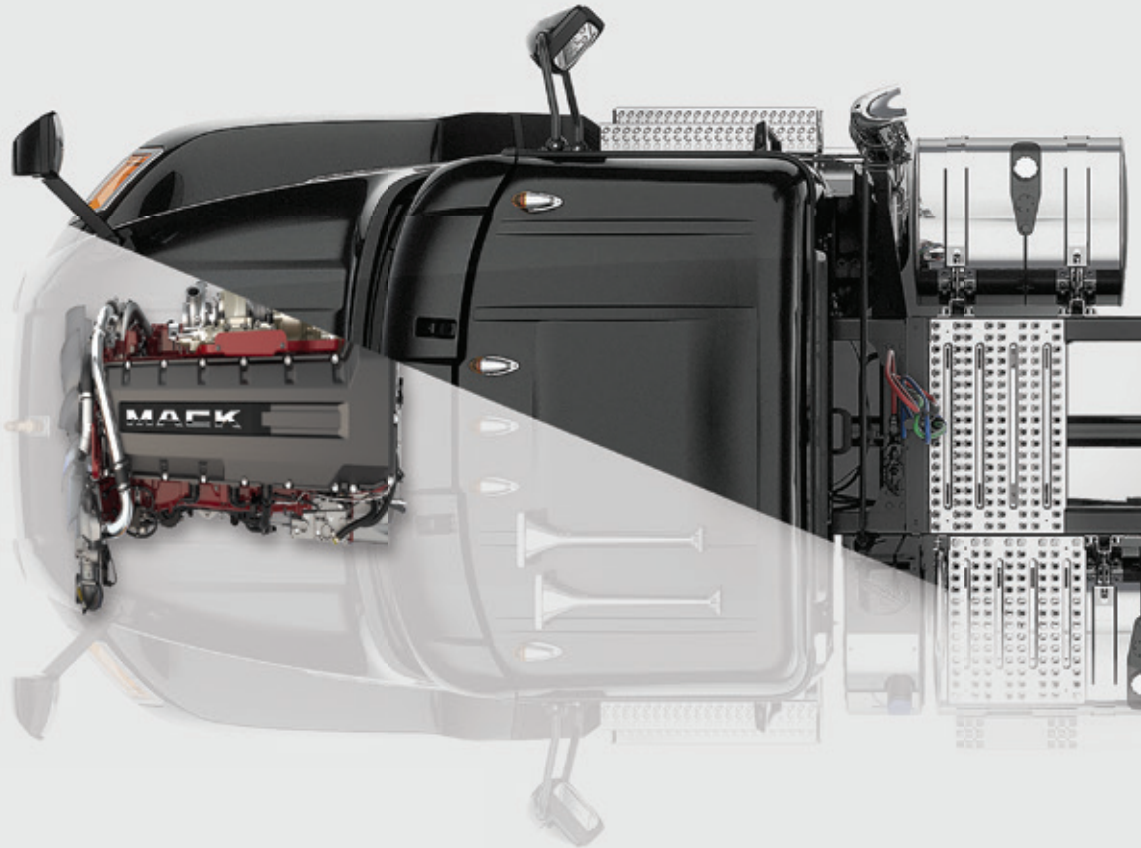

MP® Engine

Our engine compartment design enables easy access to components to help ease service operations and cut down on service times.

Single-Point Latch and Tilt Assist

Requires 50% less effort to open for easy access to the engine.

Level Check

All fluid checks and fills are visible and reachable from the ground for easy fill and daily checks.

3-Piece Hood

The 3 pieces are bonded together but can be separated and repaired individually for lower replacement costs.



3-Piece Bumper

The 3 pieces can be ordered as separate replacement parts for improved serviceability and lower repair costs.



Designed for the driver.

Mack's cab design and driver environment are built around the way work gets done on the road, keeping drivers comfortable, safe and focused all day long.





Everything in Reach

The intuitive instrument panel and steering wheel of the Mack cabs give drivers total confidence and control in the cockpit.



Comfort For The Long Haul

A spacious interior and American craftsmanship give drivers the comfort they need to feel at home.



Utility From Top To Bottom

Configure Mack's best-in-class storage for as much or as little as you need to store.

Control at your fingertips.

Built to work and designed with purpose, the automotive-inspired controls of the Mack cab make operation easy, safe and comfortable.



1. Information and Entertainment Display

7" touchscreen, along with smart steering wheel buttons, manages tools like SiriusXM®, Weather Band, TomTom truck navigation, Apple CarPlay and optional back-up camera.

2. D-Panel Gauges

Customize the dash with 4 optional auxiliary gauges.

3. Illuminated Controls

Keep eyes on the road with familiar, automotive-style controls.

4. Flat-Bottom Steering Wheel

An industry-first, allowing more belly room and clearance for entry or exit. Add to that a racecar-style grip, enhanced dash visibility and clipboard-friendly surface for better control and maximum comfort.

5. mDRIVE Controls

Intuitive placement—and the option to install it even higher on the dash—gives drivers comfortable access without taking eyes off the road.

6. Rocker Switches

New larger, robust rocker switches are laser etched to be readable for life



Power Window, Lock and Mirror Controls

Provide more comfort and control than manual windows.



Light Control Module

Runs all exterior lights from one place with an automotive feel.



Left Stalk

Manages high beams, self-canceling turn signals and wipers.



Right Stalk

Manages engine brake and Co-Pilot™.

Information at a glance. Eyes on the road.

Drivers manage constant demands on their attention. Our instrument panel brings important information to the forefront, keeping it clear and readable so drivers can stay focused on the road ahead.

1. Digital-Analog Gauges

Solid dial hands with the precision of digital instruments.

2. Mack Co-Pilot™

5" full-color digital display provides enhanced visibility and simpler navigation without distractions. Constant truck monitoring and Pre-Trip Assistant, including one-person Exterior Light Inspection, help keep an eye out for potential issues before they become real ones.



Unmatched comfort.

The spacious cab, stand up sleeper and premium materials of Mack cabs create an interior that's as comfortable as it is functional.

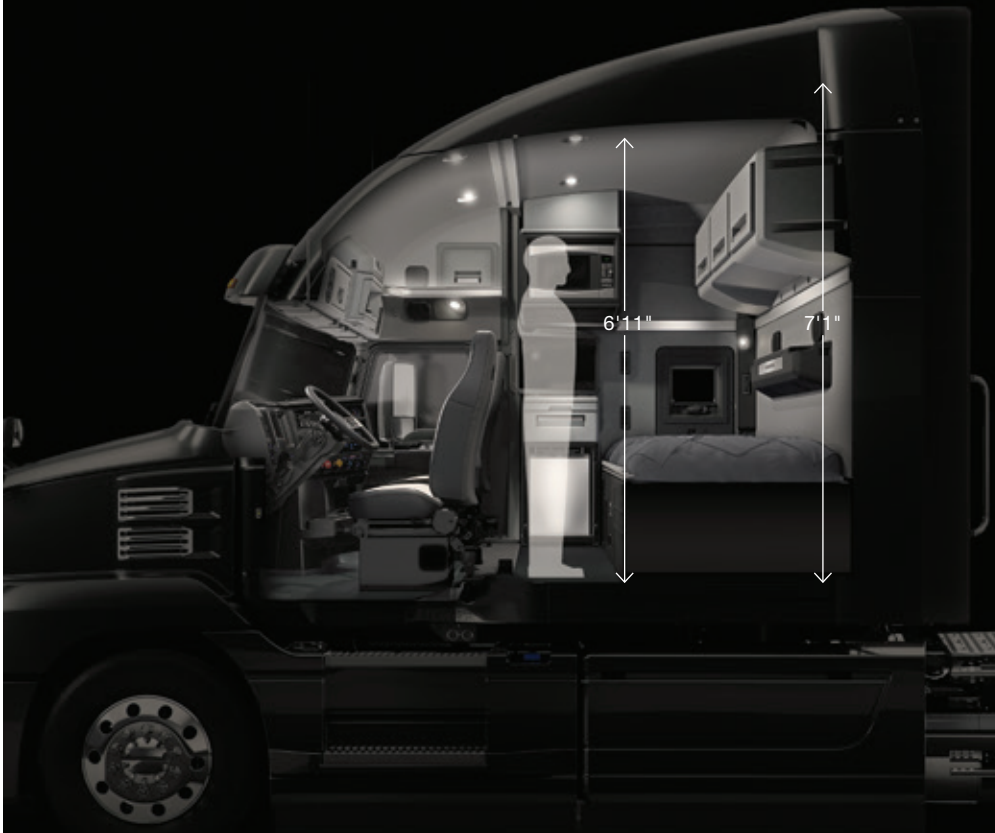

The generous ceiling height of Mack Sleepers let drivers stand up in the cab and walk right through to the sleeper. Driver model shown at 5' 10\"/>



Mack-Exclusive Seats

We partnered with Sears Seating to build seats that improve driver comfort and support, while taking on daily wear and tear.

- Air suspension
- Optional swivel base
- 30+ feature and fabric combinations

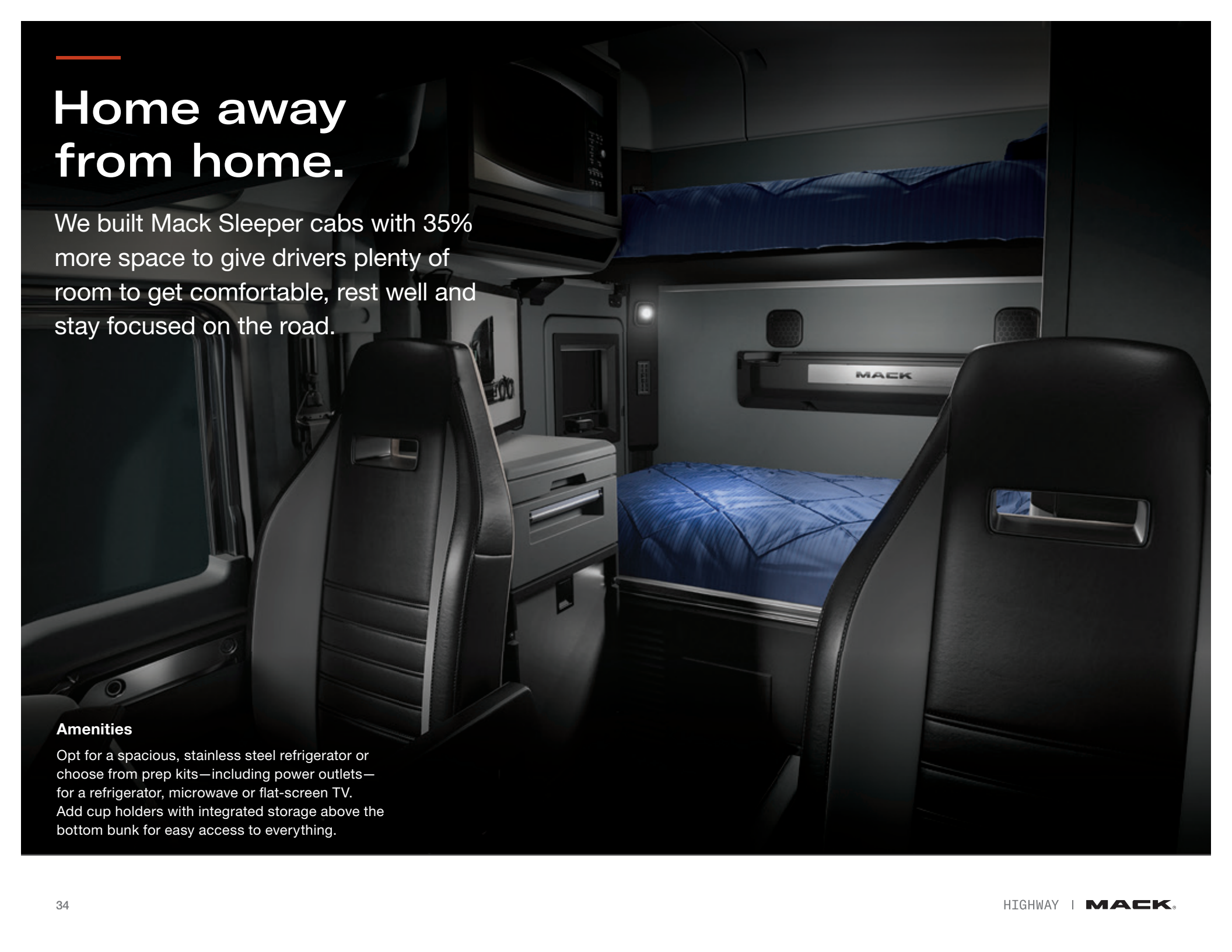
The image shows the interior of a Mack Sleeper cab. Two black leather seats with silver handles are in the foreground. In the background, there is a bed with a blue quilted blanket and a blue pillow. A flat-screen TV is mounted on the wall above the bed. The word "MACK" is visible on a panel above the bed. The overall lighting is dim, creating a cozy atmosphere.

Home away from home.

We built Mack Sleeper cabs with 35% more space to give drivers plenty of room to get comfortable, rest well and stay focused on the road.

Amenities

Opt for a spacious, stainless steel refrigerator or choose from prep kits—including power outlets—for a refrigerator, microwave or flat-screen TV. Add cup holders with integrated storage above the bottom bunk for easy access to everything.



Flexible Work Space

Versatile pull out surfaces behind the driver and passenger seats create a comfortable space for a meal or catching up on email.



Sleeper Lighting

Dimmable pipe light around the perimeter of the driver environment, bunk task light, reading lights and overhead lights are all bright, long-lasting LED.

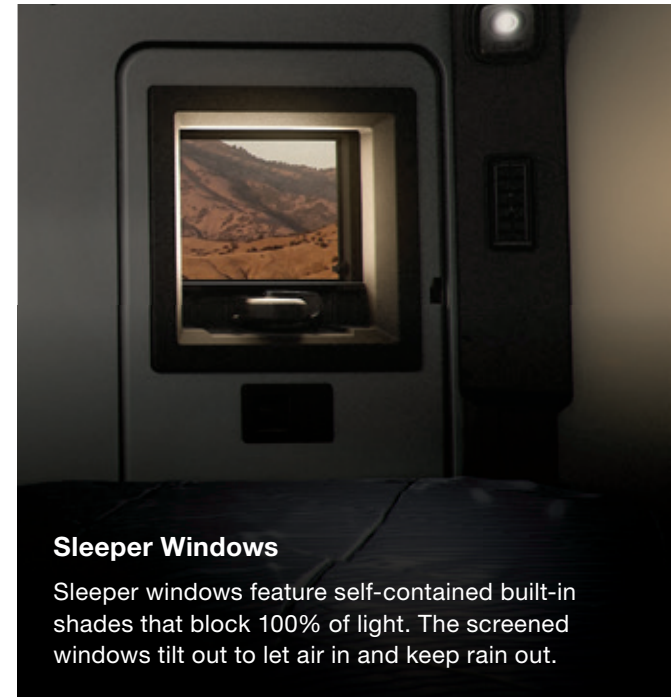

Sleeper Windows

Sleeper windows feature self-contained built-in shades that block 100% of light. The screened windows tilt out to let air in and keep rain out.

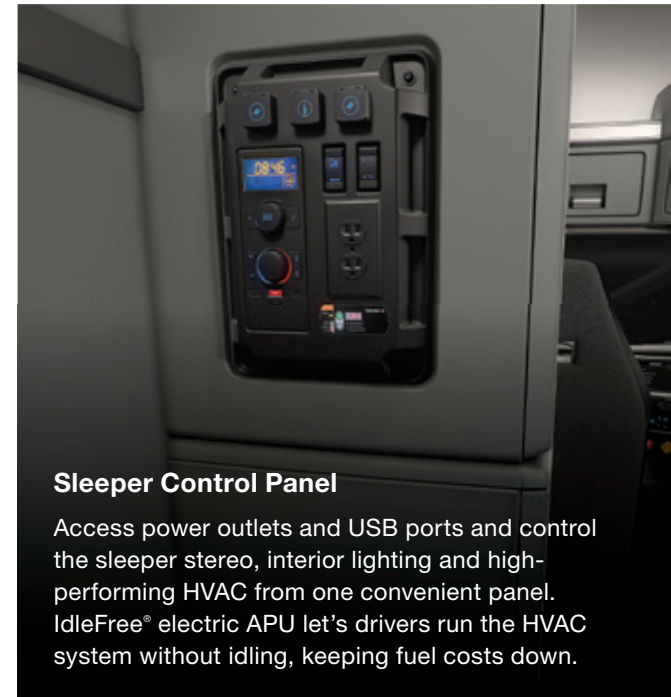

Sleeper Control Panel

Access power outlets and USB ports and control the sleeper stereo, interior lighting and high-performing HVAC from one convenient panel. IdleFree® electric APU let's drivers run the HVAC system without idling, keeping fuel costs down.

Safe, secure storage.

Even on rough roads, electronics, drinks and gear stay in place.



1. Front Overhead Console

Generous storage with tough materials, interior LED light controls and a dedicated CB radio box.

2. Side Overhead Cabinets

Deep storage areas above the driver and passenger doors create a secure space for gear in the 70-inch Stand Up Sleeper.

3. Non-Slip Electronics Tray

Charge electronics securely with the USB port, phone holder and non-slip rubber fuse relay center cover.

4. Additional Storage

Oversized cup holders fit large drinks and there's room for keys, devices and more in the easy-to-clean unit.

Everything in its place.

Mack Sleeper cabins offer cabinets, work surfaces, wardrobes and shelving to keep the living space organized, functional and ready to work.



Under Bunk Storage

Illuminated, 3-compartment storage.



Bunk Wall Storage

Back wall cup holder and open storage bin or 3-cabinet overhead storage (single bunk only).



Driver Side Storage

Tall wardrobe cabinet with hanger bar, interior mirror and magazine slots.

Cabinet with shelves, drawer and pullout work surface.



Passenger Side Storage

Microwave cabinet, DVD/storage slot, top storage.

TV prep kit (up to 24" flat panel), mounting brackets, power outlet.

Drawer-style refrigerator and storage drawer.

Microwave, TV and refrigerator spaces are also available as cabinets.

Customize the interior of your Mack cab.

Comfort Trim



Steel Gray interior trim



Gunmetal dash and door accents



Charcoal map pocket with Charcoal door insert

Preferred Trim



Steel Gray interior trim



Satin Aluminum dash and door accents

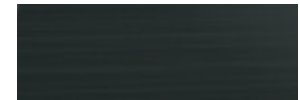

Charcoal map pocket with Charcoal door insert

Elite Trim



Steel Gray interior trim



Woodgrain dash and door trim

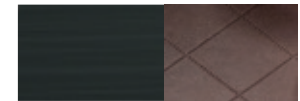

Charcoal map pocket with Dark Saddle door insert

Gold Comfort Package

Elevate your truck to the highest level of comfort.

Gold bulldog hood ornament available exclusively with selection of the Gold Comfort Package which features the following options:

- Elite Trim
- Ultraleather seats
- Mack MP engine
- *m*DRIVE transmission





Bunks and Storage

70-Inch Sleeper

Single Bunk
with lower storage



Single Bunk
with full storage



Double Bunk
with full storage





Single Bunk with full storage



Double Bunk with full storage

Your truck. Your way.

Exclusive Mack paint colors and exterior trim.

Mack Black
Axalta 932844



Graphite Gray
Axalta 932850



Liquid Silver
Axalta 932849



Arctic White
Axalta 932845



Lacquer Red
Axalta 932847



Cobalt Blue
Axalta 932846



Mountain Green
Axalta 932848



Exterior Trim
Bold Black



Exterior Trim
Mirror Chrome
Bright





Maximize your uptime with Mack.

Mack's exclusive uptime and productivity solutions combine intelligent software, predictive analytics, driver assist technologies and more to help you keep your trucks—and your business—moving forward.



Partner Integrations

Our open platform sends vehicle data directly to your own fleet management software for analysis, so you're not locked into a proprietary system.

Partners include:

Verizon Connect

Advanced fleet management and compliance tools that integrate directly with GuardDog® Connect or your own smartphone, tablet or other connected device.

Geotab®

Business intelligence and benchmarking data for older fleets to improve productivity, reduce fuel consumption, enhance driver safety and improve compliance.



Driving Innovation

The trucking business is all about making margins and driving efficiency. Get the most out of your trucks and your drivers with built-in fuel management and driver assist technologies.

Mack Predictive Cruise

Proprietary Mack technology that stores hilly terrain in GPS data to optimize engine speed and fuel efficiency on saved routes.

Infotainment

Bluetooth cell phone integration, satellite radio, Apple CarPlay and back-up camera options to make life on the road as enjoyable as possible.

Bendix® Wingman® Fusion™ 2.0

Driver assist and safety technology combining radar, camera, brakes and alert systems via the SafetyDirect® web portal from the leader in collision mitigation.

Roll Stability

The Bendix ESP® full-stability system helps drivers mitigate rollovers and loss-of-control in situations on wet and dry roadways through advanced sensors and throttle and braking interventions.

Preventive Maintenance

Keep your trucks in top shape by planning a service schedule that matches the usage and miles of your vehicle, so we can repair or replace components before it impacts your business.



Integrated Uptime Package

Harness the power of intelligent operating and maintenance systems that reduce repair times and streamline the service processes.

GuardDog® Connect

GuardDog Connect automatically monitors your truck's performance and quickly alerts OneCall of any maintenance or repair needs. OneCall's 24/7 support and roadside assistance leverages Mack ASIST to give drivers, dealers and Uptime Center staff access to all of the repair information they need—all while you're still on the road.

Over The Air (OTA) Software Updates

Wirelessly updates software without disrupting your schedules, while increasing operational efficiency and uptime. Requires GuardDog Connect.

OneCall®

The OneCall team provides 24/7 full-service support with a network of experts to keep you and your drivers ahead of any problem.

Mack ASIST

For repair coordination and communication, Mack ASIST assembles consistent, complete and professional estimates of service recommendations.



Support at every turn.

Nearly 400 authorized dealers and parts and service locations coast to coast. Nearly 1,400 Master Technicians. When you need assistance, the Mack network is ready to deliver.



Certified Uptime Dealers

Average trucking industry dwell time for a repair is 4 days, but the average repair actually takes less than 4 hours. Mack's Certified Uptime Dealers identify the quick fixes and put them in the fast lane for completion, while giving larger repairs the attention they need.

Investing In Service

The Mack Dealer Network is committed to quick, quality service. That's why our dealers have invested nearly \$600 million since 2010 to modernize facilities, improve access to parts and train service professionals to help get you back on the road.

Family Experience

Whether you're behind the wheel or managing the fleet, when you run with Mack, you're part of the family. That means you'll always get personalized attention and the support you need. Just pick up the phone; there's always a real person ready at the other end of the line.

Mack OneCall®: 1-800-866-1177.





Your business. On your terms.

You know your business better than anyone.
So Mack Business Services offers you
dedicated experts and flexible terms to help
you get into a Mack and get out on the road.





Mack Financial Services

Mack offers comprehensive financial services that include customized loans, leases and payment plans. You choose the terms, then Mack comes up with the payment plan and coverage that works for you, so you can build your business.

Mack Leasing System

Mack offers full-service leasing and rental services backed by our growing association of MLS dealer members. Whether you're looking to lease your fleet, rent a truck or outsource your maintenance, Mack has a variety of solutions to meet your needs.

Warranty and Protection Plans

Mack offers the most flexible warranty program in the industry. Whether you need a standard warranty or a premium protection plan, Mack can customize a plan to meet your specific business requirements.

MACK®

©2023 Mack Trucks, Inc. All rights reserved. Mack, Mack and the Bulldog design, Bulldog and all other marks contained herein are registered trademarks of Mack Trucks, Inc. and/or Mack Trucks, Inc. affiliated companies. All other marks contained herein are the property of their respective owners.