

1985

Ford Mustang

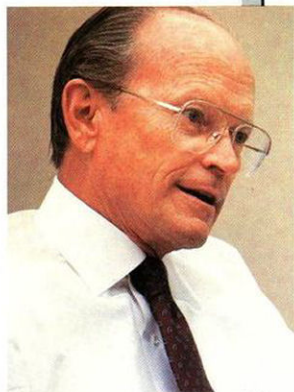



Donald E. Petersen
President

Ford Motor Company
The American Road
Dearborn, Michigan 48121

Dear New Car Buyer:

Quality is Job 1 at Ford Motor Company. This isn't just a phrase. It's a commitment to total quality.

Total quality begins with the design and engineering of our cars and continues through the life of the product. We plan them with a vision of the customer — of you — sitting behind the wheel of a new car.

Total quality will be apparent to you through functional performance, overall vehicle integrity, the "look and feel" of materials, satisfying aesthetics, safety, serviceability and cost of ownership.

Total quality requires continuous improvement in everything we do. Every employee at Ford Motor Company is involved in the process of meeting your needs and expectations.

I think the 1985 Mustang is an excellent example of the quality I'm talking about. Its driver-oriented design and advanced engineering features make it fun to drive. And Mustang's range of models and powertrains make it a versatile performer.

I invite you to look over our new 1985 Ford cars in your dealer's showroom. Test drive them on the road. When you do, I think you'll understand all that's involved in the total quality concept at Ford Motor Company.

Donald E. Petersen
President
Ford Motor Company

Ford Mustang for 1985

Mustang is the spirit that moves you. It is a car for all people and has all the necessary ingredients to satisfy the tastes of the young and the young at heart. Quick, sure handling. Responsive, efficient* power-teams. Contemporary size and shape. Plus comfortable interiors with many extra value features. All things considered, you could be driving a Mustang. Take one for a test drive soon and get in the spirit.

*See Gas mileage on page 9.

Contents

Quality and Workmanship	4-5
Ride and Handling	6-7
Power and Efficiency	8-9
Ford Mustang Environment	10-11
Ford Mustang LX	12-13
Ford Mustang LX Convertible	14-15
Ford Mustang GT	16-17
Ford Mustang SVO	18-21
Features, Options, Colors and Trims	22-23
Safety Features	24
Owner Information	25



Mustang LX, in 2-door, 3-door and convertible models, is packed with extra value standard equipment. The 2-door also comes with a very attractive price.



Mustang LX Convertible combines the fine points of the 2-door with a power retractable top for true open air cruising.



Mustang GT 3-door and GT Convertible are excellent performers on all fronts. They have quick acceleration and firm suspensions for solid road holding capability.



Ford SVO was developed by Ford Special Vehicle Operations group to set a new standard in affordable grand touring cars. It is an extremely well-balanced performance machine with numerous high-tech features.

Front and back covers: Mustang GT shown with optional rear window defroster.

A word about this catalog: Some of the equipment shown or described throughout the catalog is available at extra cost.

Quality and Workmanship

Ford Motor Company is committed to building cars that meet the high quality standards expected by those who drive them.

Every aspect of the car's design has a purpose, whether it be aerodynamic efficiency or interior comfort.

Engineering systems — the engine and suspension, for example — are

manufactured and assembled under strict quality controls.

The hood, doors, decklid, moldings — everything has stringent fit tolerances. The paint finish is smooth and lustrous.

Behind the quality of every Ford car are the dedicated people who produce it.

Design and engineering, where quality begins.

Quality demands that before a car can be built right, it must first be designed and engineered right.

Today, engineers can measure with amazing accuracy how a car responds to actual on-road conditions long before it is built. It's done with simulations of full-scale vehicles and individual components in action on computer screens.

Vehicles can be driven around pylons at various speeds, climb steep grades, run over potholes, just as they would be in real testing at a proving ground. The computer displays in close detail the intricate movements of the suspension and other systems. They're evaluated to high standards of performance, redesigned and retested if necessary.

Even with this advanced technology, however, the art of automotive design and engineering remains in the hands of designers and engineers. The computer is there to assist them.

Withstanding stress. The ultimate test of a car's quality.

Drivers expect their cars to function properly in everyday use. So Ford cars are road-tested over hundreds of thousands of miles, are subjected to extreme stress and load conditions over paved and unpaved surfaces, up and down steep grades, through corrosive salt baths. They run the full course of demanding acceleration, cornering and braking maneuvers.

But even before these road tests, Ford engineers put prototype cars through numerous laboratory tests. The Electrodynamic Actuator, for example, drives a car continuously under a variety of road and weather conditions. One objective is to eliminate squeaks and rattles caused by bumps and jolts and the effects of hot and cold temperatures.



Left: Mustang SVO

Computers, robots and lasers in manufacturing and assembly.

Monitoring engine performance, checking electrical systems for accuracy, helping ensure smooth paint applications for finish quality — these are some of the vital roles that computers play in the assembly of Ford cars.

Ford places great importance also on robotics to achieve high quality in fit, finish and function. Robots are programmed to provide consistency and control to an extraordinary degree. They can do the 2,000 welds on a car's body quickly, completely, with the precision the blueprints demand.

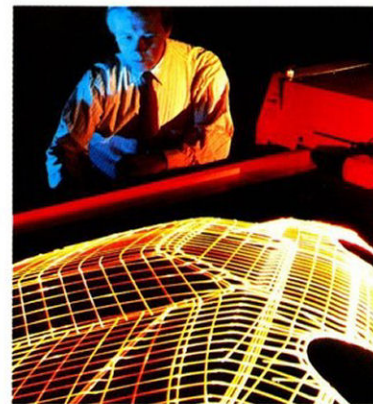

The laser, another advanced-technology tool, improves quality by providing accurate measurement of everything from engine castings and door margins to nuts and bolts and fasteners.

Special quality steps: Corrosion protection.

Ford takes tough measures to protect its cars against the damaging effects of corrosion. Galvanized steel is used for important underbody and structural parts. Pre-coated steel, featuring corrosion inhibitors, is also used in major body panels. Special treatments are applied to selected areas of the body structure.

Ingenuity and teamwork. The essential ingredients of high quality.

At Ford, striving for high quality is a team effort. This is nowhere more evident than in the hundreds of recommendations for quality improvements submitted every year by more than 1,100 Employee Involvement (EI) groups in 65 Ford plants across America.

In addition to the EI groups, there are "durability-reliability" teams specially trained to carry out extensive quality control programs before production begins, and "quality" teams whose primary responsibility is quality improvement after production gets under way.



With all the technology and resources at work producing quality products, the people at Ford realize that quality is a never-ending preoccupation. This attitude is essential to Ford's total commitment to quality.

Ride and Handling

Power-assisted rack and pinion steering

Mustang's standard power-assisted rack and pinion steering system has a low friction design. It is smooth, responsive and provides a good feel of the road.

The feel of rack and pinion steering is firm, precise and adds to Mustang's fun-to-drive qualities. And it contributes to Mustang's tight turning diameter of just over 37 feet, an important factor in overall maneuverability.

Mustang GT and SVO feature power-assisted rack and pinion steering with a constant ratio design (15:1) that provides easier maneuverability and an excellent feel of the road.

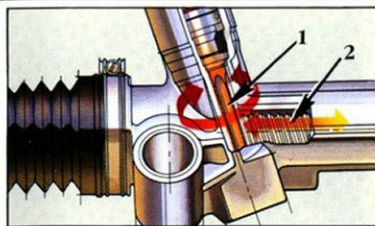

At the end of the steering column is a "pinion gear" (1), which engages a "rack" (2), of gear teeth that's linked to the steering arms.

A front suspension system designed for smooth handling

A principal contributor to Mustang's smooth and precise handling is the design of the front suspension system. In the Mustang's modified MacPherson strut design, the strut (3), or shock, replaces the upper arm and joint. A stabilizer bar (4) connects the right and left lower suspension arms to promote flat, stable cornering.

Brake design for efficient, effective stopping power

Just as it's important to design a car to

move efficiently, it's equally important to design a brake system that will stop it efficiently and effectively. Mustang LX and GT use a dual service braking system with standard power front disc/rear drum brakes. The front discs are the pin slider type designed to reduce brake drag. The one-piece hub and rotor casting is vented for better heat dissipation than non-vented designs.

SVO is equipped with power-assisted disc brakes at *all four wheels* for the optimum in high performance braking.

Left: Mustang GT shown with optional rear window defroster.

Rear suspension design

Mustang's rear suspension is a four-bar link design. It features four longitudinal arms that help control the position of the rear axle. Coil springs and shock absorbers, mounted vertically outside the rear rails, contribute to overall ride control. Large rubber bushings are used at all suspension attachment points to minimize transfer of road noise and vibration to the body.

Mustang GT

The front suspension components include gas-filled struts, upsized stabilizer bar and variable rate springs.

Variable rate springs and a stabilizer bar are also used in the rear Quadra Shock suspension that also features gas-filled shocks (5) mounted vertically between the outer ends of the rear axle and the rear



Airflow as a stabilizing force

Mustang's aerodynamic shape does more than help the engine deliver excellent economy.* The steering and suspension systems benefit as well. Through careful fine-tuning of selected design areas, air-flow is directed to reduce front and rear lift for directional stability and cornering agility.

Special VR tires for Mustang GT and SVO

The handling capabilities of Mustang GT and SVO are greatly enhanced by speed-rated, steel-belted radial ply Goodyear Eagle performance tires. The tires, mounted on cast aluminum wheels, feature a new unidirectional "Gatorback" tread design.

Special suspensions for two very special Mustangs — GT and SVO.

The suspension systems included with Mustang GT and SVO are designed to match the characteristics of these higher performance Mustangs.

frame. These shocks soften and smooth the rear wheels' vertical travel caused by bumps, pavement breaks, potholes, etc.

Another pair of freon-filled axle dampers (6) are mounted horizontally between the ends of the rear axle and the frame. They, along with the stabilizer bar, help to control the axle's fore-and-aft movement and resist torsional roll. They also help keep the axle in the proper location when cornering.

Mustang SVO

SVO takes this excellent design one step farther with the use of Koni® adjustable gas-filled struts and shocks. The adjustable feature lets you select the kind of ride you want, whether it be city (soft) or straight competition (firm). See page 21 for more details.

*See Gas mileage on page 9.

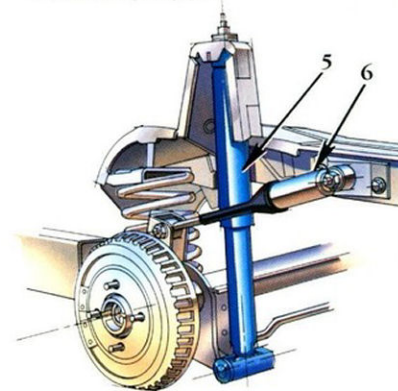

Power and Efficiency

EEC-IV: one of the world's most advanced automotive computers

The EEC-IV computer control system used on most Mustang engines is a fourth generation, state-of-the-art, microprocessor-based engine control system capable of processing thousands of operations per second. EEC-IV adjusts the air/fuel mixture and ignition timing for quick cold



Turbocharging: efficient power

Turbocharging is one answer to the challenge of obtaining power and

starts. On the road, it constantly senses what the car is being asked to do, then balances the air/fuel mixture and timing for optimum power, response and efficiency.

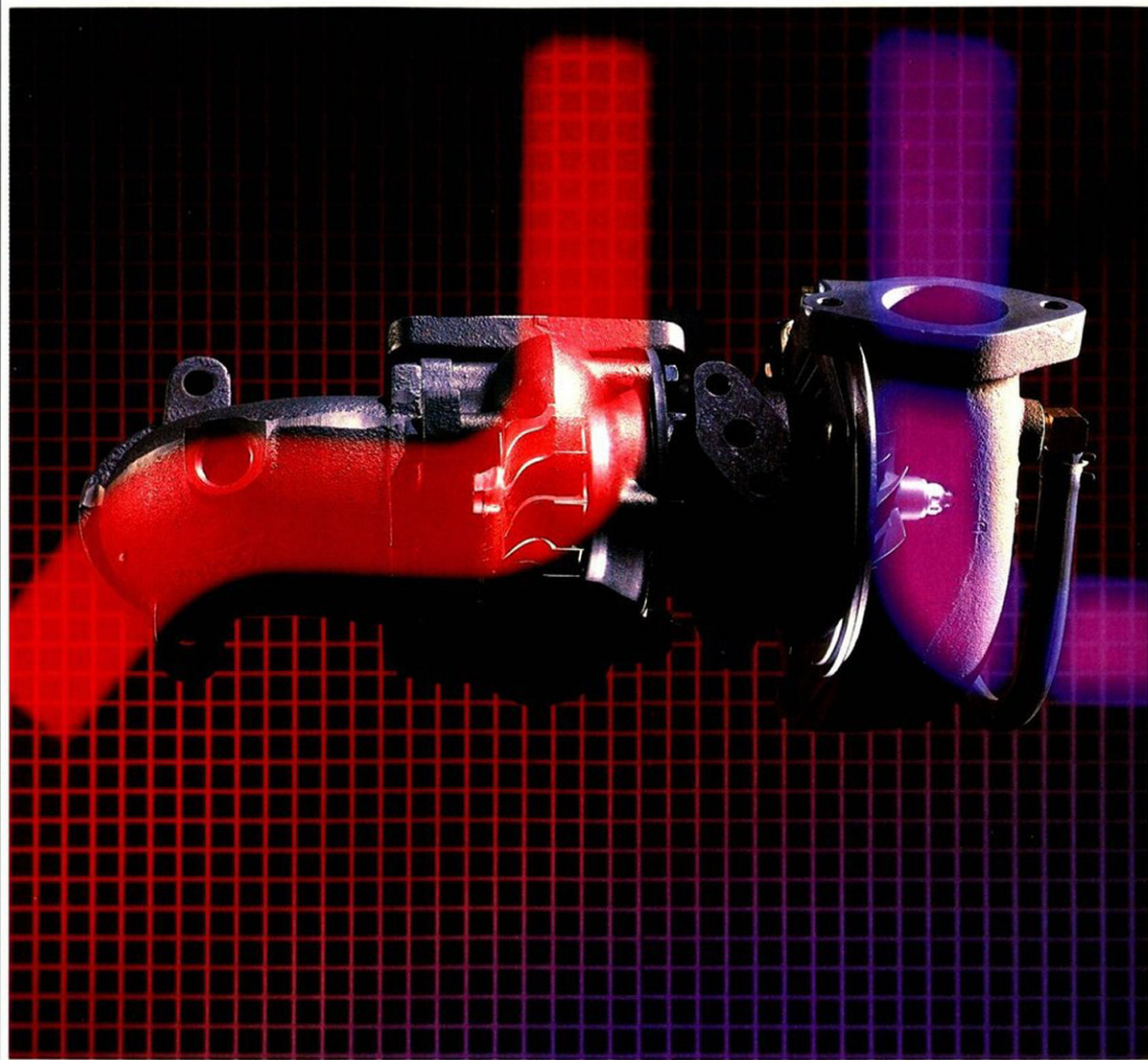

efficiency. It provides two major benefits: Under normal driving circumstances, the turbo efficiently remains inactive, contributing to fuel savings. But when a surge of power is required, such as when passing, pressing down on the accelerator brings the turbo into action.

Turbocharged, intercooled power: Mustang SVO

Mustang SVO's engine is an efficient, high-performance cross-flow head, overhead cam 4-cylinder. It displaces only 2.3 liters, yet through turbocharging and intercooling, delivers horsepower and torque comparable to much larger V-8 engines. Because of its small displacement and light weight, the engine also contributes to SVO's exceptional balance.

The engine also includes five main bearings, forged aluminum pistons, high-temperature alloy valves, auxiliary oil cooler, tuned intake manifold, automatic fuel shutoff, a refined "knock" sensor, and a rev-limiter.

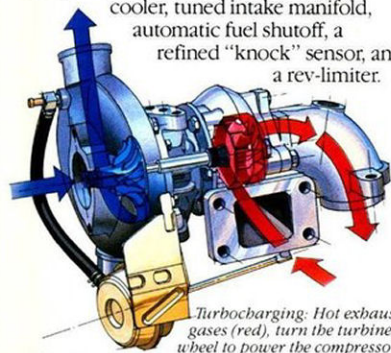

Turbocharging: Hot exhaust gases (red), turn the turbine wheel to power the compressor. Outside ambient air (blue), enters the compressor and is blown through the intercooler to the induction system and into the combustion chambers. The intercooler lowers the temperature of the air charge supplied by the turbo. This allows a denser air/fuel charge for a faster, more complete burn.

Mustang powerteams

Engine	Transmission	Final Drive Ratio		
		49 States	California	High Altitude
2.3L 1V OHC	Manual 4-speed*	Std	Std	Std
2.3L 1V OHC	Automatic	3.08:1	3.08:1	3.45:1
2.3L EFI Turbo with intercooler	Manual 5-speed	3.73:1	3.73:1	3.73:1
3.8L EFI	Automatic with locking torque converter	2.73:1	2.73:1	2.73:1
5.0L HO 4V	Manual 5-speed	2.73:1	2.73:1	2.73:1
5.0L EFI HO	Automatic Overdrive	3.27:1	3.27:1	3.27:1

*Includes upshift indicator light.

A high performance 5.0L V-8: Standard in Mustang GT

Mustang GT's powerteam consists of the 5.0 liter High Output V-8 engine and 5-speed manual overdrive transmission.

The performance components included in the design of this High

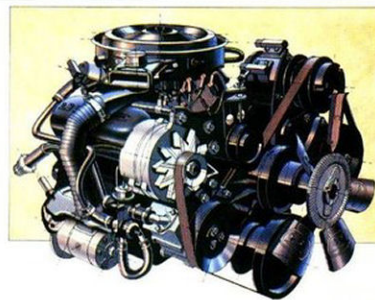

system and electronic fuel injection. EFI provides precise fuel delivery for prompt start-up and good cold engine response.

A powertrain with an accent on efficiency

The 3.8 liter V-6 engine (standard in Mustang LX Convertibles and optional in LX 2- and 3-door models), features electronic fuel injection, advanced



Output engine result in projected statistics like these: 210 horsepower at 4400 rpm and 265 ft.-lb. torque at 3200 rpm. (based on SAE standard J-1349).

Some key components that give it its high performance capability are: a high performance forged camshaft, low-friction roller tappets, 600 CFM Holley 4-barrel carburetor, large free-breathing air intake system, stainless steel tubular headers, large diameter exhausts, and forged aluminum pistons.

Additional performance features include a high efficiency water pump, premium exhaust valve and valve spring materials, double roller timing chain, wide-open throttle alternator cutout.

A Borg-Warner 5-speed manual overdrive transmission and Traction-Lok rear axle help transfer the power to the pavement.

combustion chamber and intake valve design. It's teamed with an automatic transmission designed for efficiency, too. It features a locking torque converter which provides a near mechanical linkup between engine and transmission in third gear. This results in considerably less torque converter slippage for more efficient use of power.

A responsive, efficient powertrain

The 2.3 liter overhead cam four-cylinder engine sets a fine all-around standard for Mustang LX. The efficient overhead cam design and single venturi carburetor, along with the new EEC-IV computer, deliver excellent fuel economy. The standard transmission is a 4-speed manual with SelectShift automatic transmission available as an option.

Gas mileage

1985 EPA mileage estimates were not available at the time this catalog was approved for printing. As soon as EPA figures are released, your Ford Dealer will be among the first to receive this information and will be happy to pass it along to you.



A version of this High Output engine has been tailored for use with Ford's Automatic Overdrive transmission by incorporating the EEC-IV engine control

Ford Mustang Environment

Mustang ergonomics

Correct interior design involves the application of the science of ergonomics: the close relationship of the driver to the car. Instruments, controls, seating — all must be positioned for maximum efficiency and comfort.

In Mustang, applied ergonomics creates an environment with sensible, convenient placement of seats, controls, instruments and lights. For example,

instrumentation is unobstructed by steering wheel spokes. The steering column mounted levers that control the washers, interval wipers and signals are at the driver's fingertips. The parking brake lever is located between the seats in the console (standard equipment on LX 3-door, GT and SVO). The climate control and entertainment centers are placed a comfortable reach away, so the driver's hands can stay close to the steering wheel.

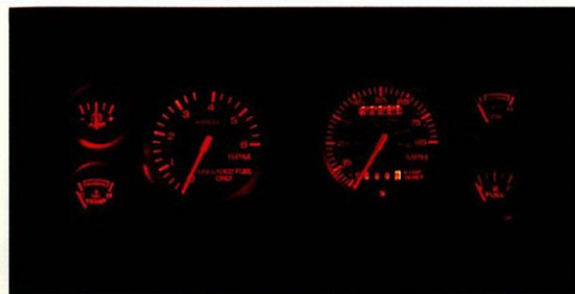

Interior comfort for four

Mustang's roomy, comfortable interior provides ample space for four passengers, plus the versatility of the split/fold rear bench seat in LX, GT and SVO 3-door models.

The front bucket seats of LX models have deep foam padding over a spring steel mat for firm yet comfortable support. The seat back angles are fully adjustable for individual comfort. The seat side bolsters and seat back give good lateral support to hold you in place.

Inside the GT are articulated sport seats which feature adjustable side bolsters and under thigh support.

Mustang SVO provides the ultimate in driver and passenger comfort with multi-adjustable, articulated front performance seats. Seat adjustments include seat cushion side bolsters, lumbar support, under thigh support and seat back angle.

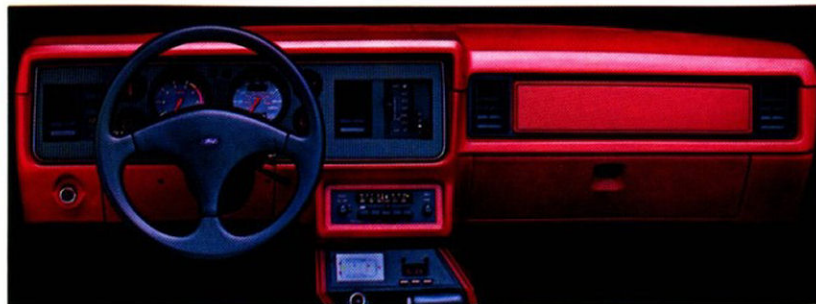
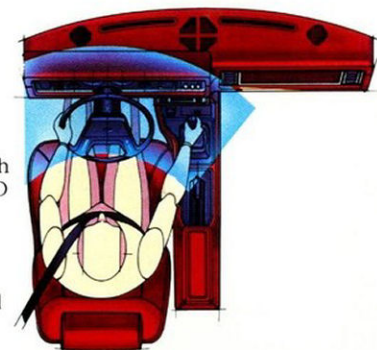

Top: Standard full instrumentation

Center: Mustang LX interior shown with optional air conditioning, SelectShift automatic transmission (standard in LX convertible) and tilt steering wheel.

Left to right: Mustang LX instrument panel shown with optional air conditioning, SelectShift automatic transmission (standard in LX Convertible) and tilt steering wheel. Split/fold rear bench seat (standard 3-door models).

Near right: Mustang SVO seat construction.

Ford Mustang LX

In Mustang LX, you have a well-appointed sporty car with power rack and pinion steering and power brakes for crisp handling, plus an efficient, responsive powertrain.* The driver-oriented interior is comfortable with well-tailored seating. LX is a *complete* car; no need to add a lot

of options to make it live up to your expectations. It's very affordable too. But, the best part is it's a Mustang.

Standard interior features include AM/FM stereo radio,** dual-covered visor mirrors, interval wipers, deep 16-ounce carpeting and low back reclining bucket seats that are cloth-trimmed. The rear seat of the 3-door LX is a split/fold design to give you a more versatile passenger/cargo area. A center console that houses a digital



clock and a graphic display warning module is standard in LX 3-door models and optional in 2-door models. The instrumentation, like the car, is complete. It includes oil pressure, coolant temperature and ammeter gauges plus a resettable trip odometer and tachometer. LX 2-door models also include a completely trimmed trunk.

*See Gas mileage on page 9.
**May be deleted for credit.



Left: Mustang LX 2-door

Ford Mustang LX Convertible

The Mustang tradition lives on in a Convertible model complete with power retractable top and room for four passengers. The rear window is glass and can be left in place when the top is lowered or

zipped down with the top up for added ventilation. A lively 3.8L fuel-injected V-6 with automatic transmission under the hood provides the power.

The same attention is given to the interior as in the LX 2-Door, which includes, among other items: Covered



visor mirrors. Multi-function column-mounted controls. Interval wipers. Dual remote-control styled mirrors. A power ventilation system with integral dash-mounted registers. Plus P-metric steel-belted radials, turbine wheel covers and charcoal exterior accents. There is also a leather articulated seat option available in your choice of white or charcoal.

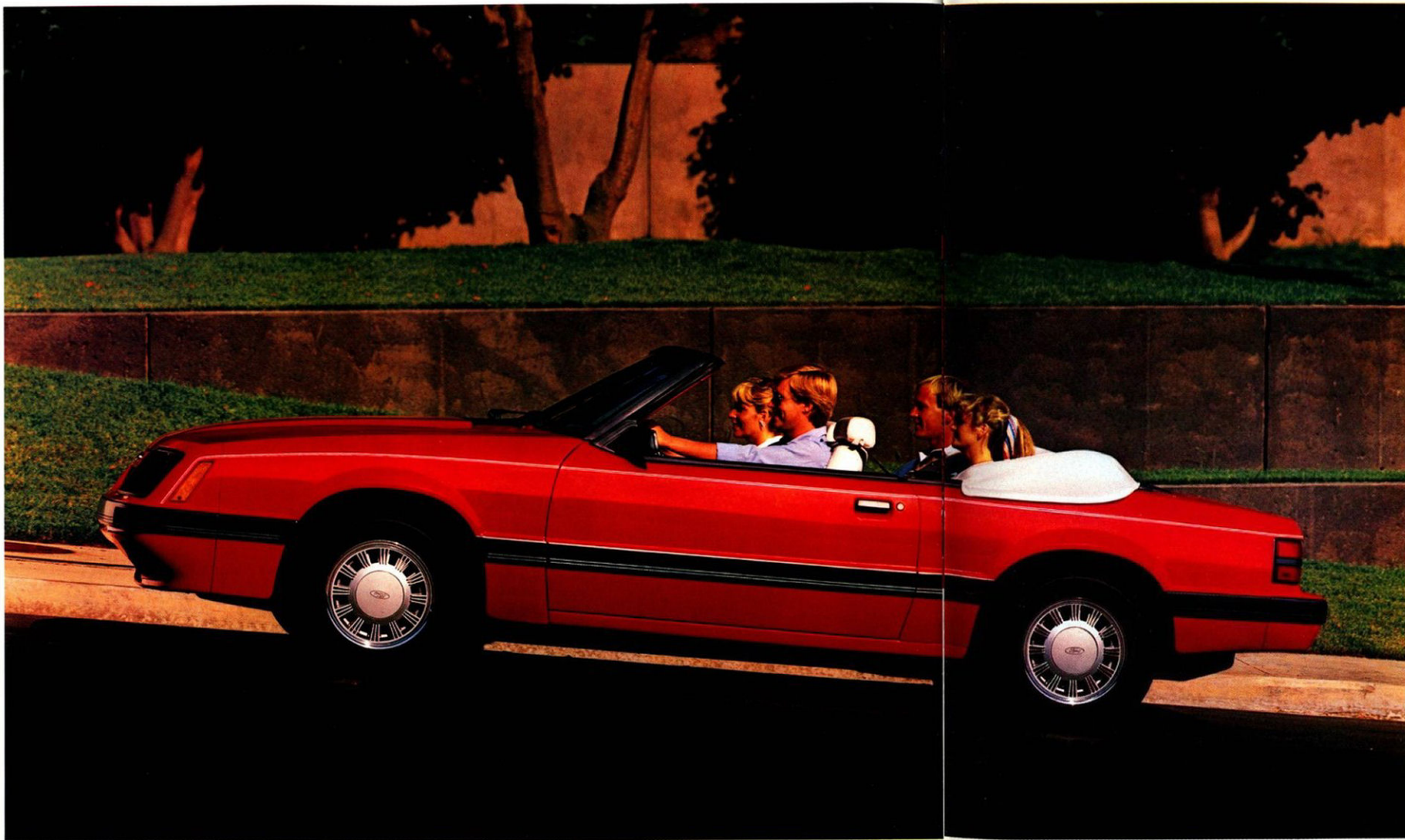

Left: Mustang LX Convertible shown with optional leather seating surfaces and styled road wheels.

Ford Mustang GT

There's a certain reputation and respect that has followed Mustang GT since its introduction 20 years ago. A respect for balance and, of course, quickness, that adds to GT's reputation year after year.

Mustang GT will undoubtedly add to its reputation in 1985 and garner more than its fair share of respectful nods.

You'll still find plenty of horses under the hood — 210 projected* — and you'll still find plenty to grab onto with the short, accurate throws of the 5-speed

manual transmission. But, you'll also find a new kind of ride sophistication with the refined Quadra-Shock suspension system which includes variable rate springs, gas-filled struts and shocks, and new VR-rated Goodyear Eagle performance "Gator-back" tires with unidirectional tread. There's also new 15x7 cast aluminum wheels standard on GT.

Inside, there are new cloth articulated sport seats with adjustable side bolsters and under thigh support. Other standard amenities include AM/FM stereo radio.**



Quick ratio power steering. Tilt steering wheel and power front disc/rear drum brakes.

Mustang GT performance also comes in a Convertible model, complete with power top, glass rear window and room for four.

Take a Mustang GT 3-Door or Convertible for a test drive. See how well the GT has lived up to its reputation.

*210 horsepower at 4400 rpm. Based on SAE standard J-1349.

**May be deleted for credit.



Left: Mustang GT shown with optional rear window defroster.

Ford Mustang SVO

SVO is automotive sports sophistication at its best. Nowhere is this more evident than on the inside.

The articulated front bucket seats can be adjusted for a snug, individualized fit. The seats, including Ford's rear split/fold bench, are tailored in cloth with an available option of leather seating surfaces. Adjustable front seat features include seat

back angle, lumbar support, side bolsters and under thigh support.

The complete instrument grouping is made up of accurate, easy-to-read dials and gauges.

SVO also features these very desirable standard items: Air conditioning. Power windows. Power locks. Tilt steering wheel. Interval wipers. Rear window defroster. Electronic AM/FM stereo radio with cassette player. Premium sound system. A console that incorporates an



integral armrest and storage box and houses switches for the fog lamps and fuel recalibration. The fuel recalibration switch lets you go from premium unleaded to regular unleaded fuels to optimize engine performance regardless of the fuel in use. There's also a standard performance pedal package that allows for simultaneous downshifting and braking. The interior is just one part of the SVO story. For a look at SVO's more technical aspects, turn the page.

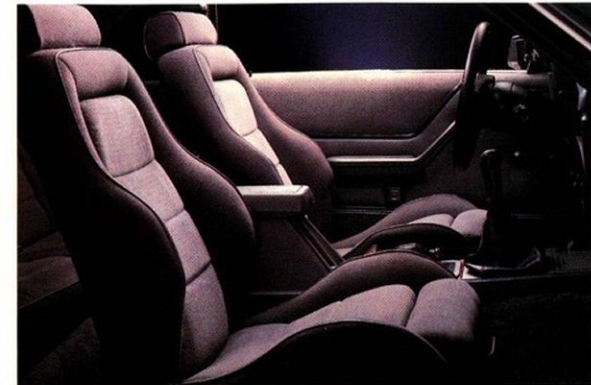

Left: Mustang SVO

Ford Mustang SVO

Competition-tested components remove all doubt.

Engine — SVO's 2.3 liter in-line 4-cylinder engine has electronic port-type fuel injection and turbocharger with air-to-air intercooler.

The turbo system includes variable, EEC-IV computer-controlled electronic turbo boost that allows infinitely variable boost up to 14 psi.

The intercooler lowers the temperature of the air charge supplied by the turbo, increasing its density. Increased density means greater combustion efficiency and an increase in both horsepower and torque.

Dual polycarbonate rear spoiler.

Functional hood scoop for air-to-air intercooler.

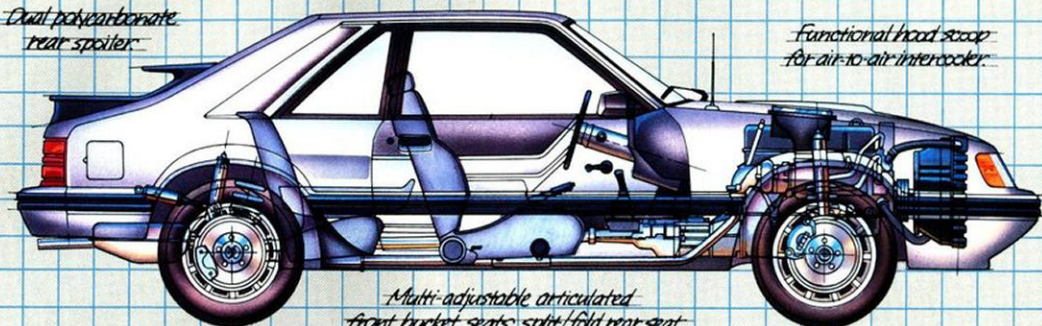

Multi-adjustable articulated front bucket seats; split/fold rear seat.

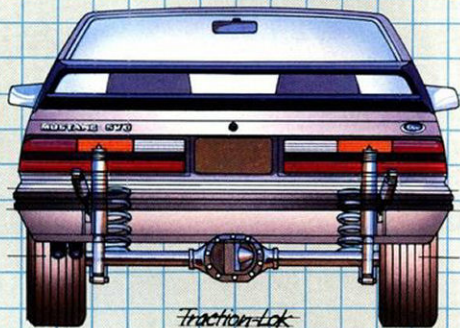

Traction-Lok rear axle.

16-inch Goodyear radials and cast aluminum wheels; adjustable gas-pressurized Koni® shocks.

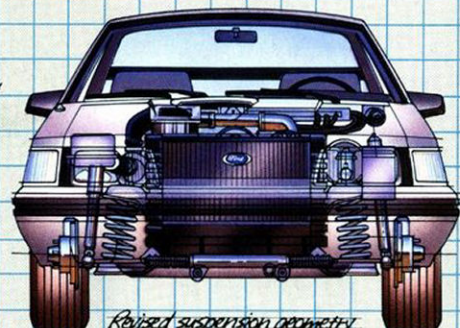

Revised suspension geometry for exceptional ride.

Mustang SVO Specifications

ENGINE	
Type	2.3L OHC in-line 4-cylinder
Piston compression ratio	8.0:1
Induction system	Electronic fuel injected, turbocharged, intercooled
Intercooler	162 cu. in. core volume
Max. power (SAE Standard J1349)	175 HP @ 4400 rpm
Max. torque (SAE Standard J1349)	210 lb.-ft. @ 3000 rpm
DRIVETRAIN	
Transmission	5-speed
Gear ratios:	
1st	3.50:1
2nd	2.14:1
3rd	1.36:1
4th	1.00:1
5th	.78:1
Shift linkage	Hurst® developed
Traction-Lok rear axle	3.73:1

SUSPENSION

Front	MacPherson struts, adjustable gas-filled Koni® shocks, coil springs, stabilizer bar (1.12-in. dia.)
Rear	4 bar link, coil springs, stabilizer bar (.67-in. dia.), adjustable gas-filled Koni® shocks, longitudinally mounted hydraulic dampers

STEERING

Type	Precision tuned rack and pinion, power assisted
Ratio	15:1

BRAKES

Front	11.08-in. internally vented discs, power assisted
Rear	11.6-in. internally vented discs, power assisted

WHEELS AND TIRES

Wheels	16 x 7-in. cast aluminum
Tires	P225/50VR16 Goodyear Eagle, Unidirectional "Gatorback" tread

DIMENSIONS

Curb weight	2,987 lb.
Wheelbase	100.5"
Overall length	180.8"
Overall width	69.1"
Overall height	52.1"
Track, F/R	57.8"/58.3"

CALCULATED DATA

Power-to-weight ratio	17.1 lb./1-HP
-----------------------	---------------

SKIDPAD

Lateral acceleration	0.9g
----------------------	------

BRAKING

60-0 mph	137 ft.
----------	---------

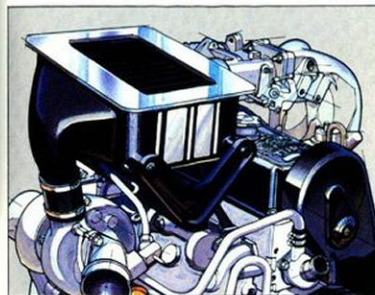

Braking system — Ample braking reserve is provided by standard power-assisted disc brakes at all four wheels. Hub and rotor castings are one piece and rotors are internally vented for heat dissipation.



Rear suspension — The SVO features uniquely tuned springs and bushings and is equipped with a large stabilizer bar for excellent control over rough surfaces and during hard use.

In the rear are gas-filled/adjustable Koni®



shocks (1), plus the additional two Koni® hydraulic dampers (2), mounted horizontally between the axle and frame.

A Traction-Lok rear axle with 3.73:1 final drive ratio is included as standard equipment to handle the demands of hard acceleration and good traction through turns.

Tires and wheels — SVO tires are race-proven Goodyear steel-belted radials. They're VR-rated, feature an aggressive, unidirectional "Gatorback" tread pattern and low profile design for a wide footprint and excellent traction on wet or dry pavement. Built of performance rubber compound, these special tires are mounted on 16-inch cast aluminum wheels that are 7 inches wide. The wheels are low pressure cast to minimize structural porosity and feature a flush aerodynamic design.



Front suspension — SVO's front suspension also uses gas-filled adjustable Koni® struts, plus the benefits of a revised geometry for additional wheel travel in comparison to other Mustangs. The front suspension components have also been retuned to contribute to SVO's ride and handling characteristics.

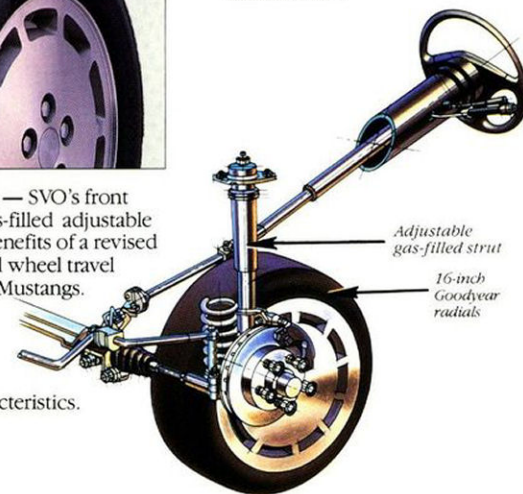

Competition Prep option

Your SVO is nearly race-ready as produced. When you order the Competition Prep option the following items will be deleted:

- Air Conditioning
- Power Windows
- Power Locks
- Electronic AM/FM Stereo
- Search Radio

Ford Mustang Features and Options

Electronic AM/FM stereo search radio/cassette player

Some of the features of this state-of-the-art quality sound system are: Dolby® Noise Reduction; seek tuning that selects the next listenable station either up or down the scale; scan tuning that auditions stations for 8 seconds; and a "music search" feature that locates the beginning of the next or previous song on the cassette tape.

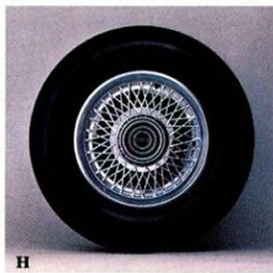
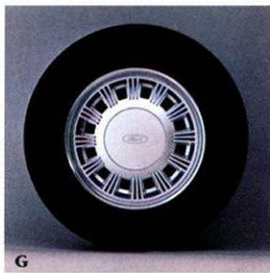
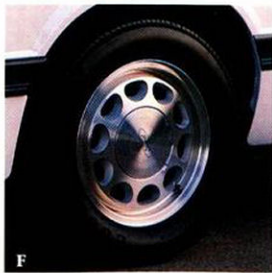
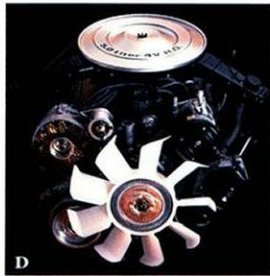
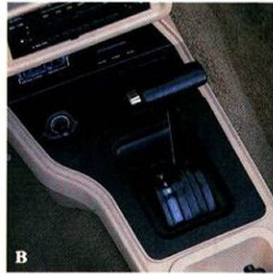

Illustrated options

(A) Electronic AM/FM Stereo Search Radio; (B) Automatic Transmission; (shown with console, optional in LX 2-door models); (C) T-Roof; (D) 5.0L HO V-8 engine; (E) Tot-Guard for children 20 to 50 pounds (available at Ford Dealers); (F) Cast aluminum 15x7 wheels; (G) Styled road wheels; (H) Wire style wheel covers.

A word about Ford options

Some of the equipment shown or described throughout the catalog is available at extra cost.

FORD MUSTANG FEATURES

	LX	GT	SVO
ENGINEERING			
2.3L OHC 4-cyl.	S	NA	NA
2.3L EFI Turbo with intercooler and unique premium/regular fuel octane selection capability	NA	NA	S
3.8L EFI V-6	S(1)	NA	NA
5.0L HO 4V V-8 with sport tuned dual exhaust	0	S	NA
4-speed manual transmission with self-adjusting clutch and upshift indicator light	S	NA	NA
5-speed manual transmission	0(2)	S(2)	S
SelectShift automatic transmission with locking torque converter	0(1)	NA	NA
Low oil warning light (3.8L V-6 and 5.0L V-8 engines)	0	S	NA
Front stabilizer bar	S	S	S
Power front disc/rear drum brakes	S	S	NA
Power four-wheel disc brakes	NA	NA	S
Gas-filled shocks (3)	0	S	S
Handling suspension package (3)	0	S	S
Power rack and pinion steering	S	S	S
P195/75R 14 BSW steel-belted radial ply tires	S	NA	NA
P225/60VR 15 Goodyear Eagle performance tires	NA	S	NA
P225/50VR 16 Goodyear Eagle performance tires	NA	NA	S
Mini-spare tire	S	S	S
EXTERIOR			
Halogen headlights	S	S	S
Color-keyed soft front fascia with integral air dam	S	S	S
Dual remote-control mirrors	S	S	S
Marchal fog lamps with covers	NA	S	S
Dual wing rear spoiler	NA	NA	S
Single wing rear spoiler (3-door)	NA	S	0
Functional hood scoop	NA	NA	S
Rear wheel opening spats	NA	NA	S
Turbine wheel covers	S	NA	NA
Cast aluminum wheels	0	S(4)	S(4)
INTERIOR			
Full instrumentation (5)	S	S	S
Steering column mounted controls for headlamp dimmer, flash-to-pass, turn signals, fluidic washer/interval wiper system	S	S	S
AM/FM stereo radio with 4 speakers (6)	S	S	NA
Electronic AM/FM stereo with cassette	0	0	S
Premium sound system	0	0	S
Low-back reclining bucket seats	S	NA	NA
Sport performance bucket seats, multi-adjustable, articulated (plus lumbar adjustment in SVO)	NA	S	S
Split fold rear seat (3-door)	S	S	S
Console includes electronic digital clock with day/date, elapsed time and stopwatch features and graphic warning display module (except in SVO where rocker switches replace the display module)	S(7)	S	S
Tilt steering wheel	0	S	S
Sport steering wheel, leather-wrapped	NA	NA	S
Leather-wrapped gearshift handle and emergency brake handle	NA	NA	S
Rear window defroster	0	0	S
Air conditioning	0	0	S
Power front side windows	0	0	S
Power locks	0	0	S
Remote-control fuel filler door release	0	S	S
Cargo area cover (3-door)	S	S	S
Carpeted luggage compartment/cargo area	S	S	S
Dual visor mirrors with covers	S	S	S
Light/Convenience Group (8)	0	0	S

- Standard with LX Convertible models, optional on 2- and 3-door LX. SelectShift automatic transmission standard with 3.8L V-6.
 - With 5.0L engine. Includes upshift indicator light.
 - Includes Quadra-Shock rear suspension. Std. on GT, SVO. Opt. on LX (included with 5.0L engine package and/or P205VR tires).
 - 15x7 on GT, 16x7 on SVO.
 - Includes tachometer, trip odometer, oil pressure, ammeter and temperature gauges. Turbocharger gauge replaces ammeter gauge on SVO models.
 - May be deleted for credit or upgraded at extra cost.
 - Optional on LX 2-door.
 - See Options Selector for contents.
- S=Standard O=Optional NA=Not Available

FORD MUSTANG OPTIONS

	LX	GT	SVO
ENTERTAINMENT SYSTEMS			
AM/FM stereo radio with cassette tape (1)	0	0	NA
Electronic AM/FM stereo radio with cassette tape	0	0	S
Premium sound with upgraded speakers and 4-channel power amplifier	0	0	S
APPEARANCE			
Flip-up open-air roof (3-door only)	0	0	0
T-roof (3-door only)	0	0	NA
Lower Charcoal Two-Tone paint (3-door)	0	0	NA
COMFORT			
Air conditioning (tinted glass recommended)	0	0	S
Tinted glass, complete	0	0	S
Articulated sport seats (2)	0	NA	NA
CONVENIENCE			
Rear window defroster	0	0	S
Speed control	0	0	NA
Tilt steering wheel	0	S	S
Light/Convenience Group (3)	0	0	S
PERFORMANCE			
3.8L V-6 engine	0(4)	NA	NA
5.0L HO 4V engine	0	S	NA
5.0L HO EFI engine package (includes AOD trans.)	0	0	NA
SelectShift automatic transmission	0(4)	NA	NA
Automatic Overdrive transmission (5)	0	0	NA
5-speed manual transmission (6)	0	S	S
Heavy-duty maintenance-free battery (54 amp-hr.) (7)	0	S	S
Single rear spoiler	NA	S	0
Higher axle ratios, Traction-Lok axles (8)	0	S	S
California Emissions System	0	0	0
POWER ASSISTS			
Power front side windows	0	0	S
Power door locks	0	0	S
Remote locking fuel door and trunk/liftgate release	0	S	S
TIRES			
P205/70VR 14 BSW	0	NA	NA
P205/70 14 NSW	0	NA	NA
WHEEL COVERS/WHEELS			
Wire style wheel covers	0	NA	NA
Styled road wheels	0	NA	NA

- All stereo radios include 4 speakers.
 - LX Convertible only. Includes adjustable thigh support, side bolsters, and head restraints. Available in Charcoal or White leather.
 - Includes lights for luggage compartment/cargo area, ashtray, glove box, engine compartment, dual beam dome/map light, headlamps-on warning buzzer.
 - Standard in LX Convertible.
 - NA with 2.3L, 3.8L EFI or Turbo engines.
 - NA with 2.3L and 3.8L engines.
 - 45 amp-hr. heavy-duty battery standard in Convertible models.
 - See your dealer for available ratios.
- S=Standard O=Optional NA=Not Available

COLORS AND TRIMS

Two-Tone Interior Trim Colors

Charcoal/Metallic
Sand Beige/Metallic
Canyon Red/Metallic
Bright Red/Metallic

Exterior Paint Colors

LX 2- and 3-Door

Medium Charcoal Metallic	•	•	•	•
Black	•	•	•	•
Silver Metallic	•	•	•	•
Bright Red	•	•	•	•
Dark Blue Metallic	•	•	•	•
Light Regatta Blue Metallic	•	•	•	•
Dark Sage	•	•	•	•
Sand Beige	•	•	•	•
Clove Metallic	•	•	•	•
Oxford White	•	•	•	•
Dark Slate Metallic	•	•	•	•
Medium Canyon Red Metallic	•	•	•	•

GT 3-Door

Medium Charcoal Metallic	•	•	•	•
Black	•	•	•	•
Silver Metallic	•	•	•	•
Bright Red	•	•	•	•
Light Regatta Blue Metallic	•	•	•	•
Oxford White	•	•	•	•
Medium Canyon Red Metallic	•	•	•	•

SVO

Medium Charcoal Metallic	•	•	•	•
Black	•	•	•	•
Silver Metallic	•	•	•	•
Bright Red	•	•	•	•
Light Regatta Blue Metallic	•	•	•	•
Oxford White	•	•	•	•
Medium Canyon Red Metallic	•	•	•	•
Dark Sage	•	•	•	•
Dark Blue Metallic	•	•	•	•
Sand Beige	•	•	•	•
Clove Metallic	•	•	•	•
Oxford White	•	•	•	•
Medium Canyon Red Metallic	•	•	•	•
Dark Slate Metallic	•	•	•	•

See your dealer for Mustang Convertible Color and Trim availability.

Some of these paint and trim colors are shown in this catalog. On the printed pages, of course, colors are at best only representative of the originals. Your Ford Dealer can show you actual samples of paint colors and trim materials represented above.

Ford Mustang Features and Options

Electronic AM/FM stereo search radio/cassette player

Some of the features of this state-of-the-art quality sound system are: Dolby® Noise Reduction; seek tuning that selects the next listenable station either up or down the scale; scan tuning that auditions stations for 8 seconds; and a "music search" feature that locates the beginning of the next or previous song on the cassette tape.

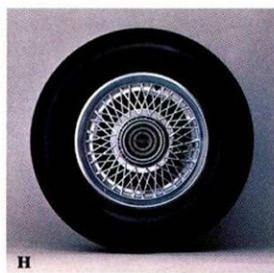
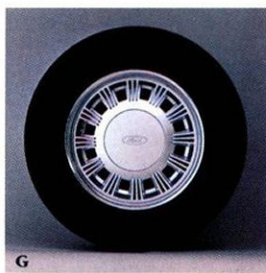
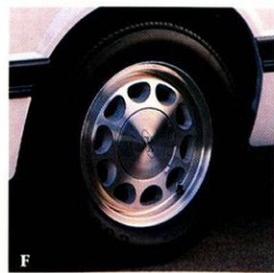
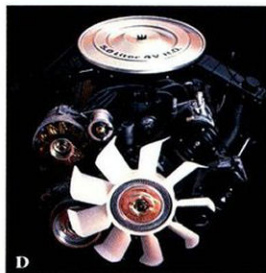
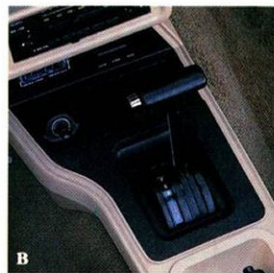

Illustrated options

(A) Electronic AM/FM Stereo Search Radio; (B) Automatic Transmission; (shown with console, optional in LX 2-door models); (C) T-Top; (D) 5.0L HO V-8 engine; (E) Tot-Guard for children 20 to 50 pounds (available at Ford Dealers); (F) Cast aluminum 15x7 wheels; (G) Styled road wheels; (H) Wire style wheel covers.

A word about Ford options

Some of the equipment shown or described throughout the catalog is available at extra cost.

Safety Features

A commitment to safety

Safety, like quality, begins as an attitude, a way of thinking that's fundamental in shaping a vehicle's structure and components from the drawing board to assembly.

Occupant safety

Ford commits enormous resources every year to the development and testing of all car lines and their occupant protection features. Body structures are carefully designed from the start with passenger safety as a primary concern. After they are validated for theoretical soundness, structures are assembled into prototype vehicles and subjected to exhaustive crash testing.

Operating safety

This term applies to a vehicle's ability, with the aid of the driver, to avoid an accident.

Ford cars are engineered to do their part — provide suspension and steering systems designed for control, as well as a brake system that is designed to provide fast stopping action and fade resistance.

Of course, it's up to the driver to make the best use of accident-avoidance equipment. This involves driving defensively, reacting in time, and such seemingly small things as properly regulating the ventilation system (to help the driver stay alert).

5-mile-an-hour bumpers

Bumpers on Mustang are designed to protect lamps, cooling system, exhaust and other body components in the event of a minor impact. While some manufacturers have replaced the 5-mile-an-hour bumper system with a 2 1/2-mile-an-hour system, Ford offers you the protection of 5-mile-an-hour bumpers, front and rear.

Get it together — buckle up.

Ford Motor Company strongly encourages all passengers to use their safety belts.

In all Ford cars, outboard front seat lap and shoulder belts have automatic retractors and comfort regulators. Outboard rear seat positions also have lap belts with retractors.

Ford urges the use of child and infant restraints, even in states where they are not required by law. Ford's easy-to-install Tot-Guard (for children 20 to 50 pounds) and Infant Carrier (for children up to 20 pounds) are available at all Ford Dealers. If a child restraint requires a top-tether, Ford cars provide for attachment of an anchor at each rear outboard seating position (except Mustang Convertible).



Ford Mustang Lifeguard Design Safety Features

Vehicle operation

- Safety rim wheels and load-rated tires
- Split hydraulic brake system with warning light
- Corrosion-resistant brake lines
- Flash-to-pass headlamps
- Turn indicator lever with lane-changing signal feature
- Hazard warning flasher
- Backup lights
- Side marker lights
- Parking lights coupled with headlamps
- Variable speed windshield wipers
- Windshield washers
- Dual outside rearview mirrors
- Glare-reduced instrument panel, windshield wiper arms and windshield pillars
- Uniform transmission shift quadrant with safety starting switch (on all cars equipped with automatic transmission)
- Continuously variable control illumination intensity (instrument cluster lighting)
- Safety hood latch system
- Function-rated windshield defroster system

Occupant protection

- Safety-designed front end structure
- Safety-designed roof structure (except Convertibles)
- Steel guard rails in side doors
- Double yoke safety door latches and safety hinges
- Integral lap and shoulder belts with automatic retractors for occupants of front seats
- Positive seat belt fastening reminder warning light and buzzer for the driver's seat
- Lap belts for rear seat occupants
- Energy-absorbing steering column and steering wheel system
- Energy-absorbing armrests and safety designed door handles
- Energy-absorbing instrument panel with padding for right front passenger
- Energy-absorbing sun visors
- Energy-absorbing front seat back tops with padding
- Self-locking front seat backs
- Head restraints for front outboard occupants
- Safety glove box latch
- Inside yieldaway rearview mirror
- Impact-absorbing laminated safety glass windshield
- Flame-resistant interior materials
- Safety-designed coat hooks
- Safety-designed radio control knobs and push buttons

Anti-theft

- Locking steering column with key warning reminder buzzer and push button key release
- Visible vehicle identification number
- Single key with anti-theft design for door entry and ignition

Damage resistance

- Impact resistant front and rear bumper systems

Owner Information

Measurements

	2-Door/3-Door
Wheelbase	100.4"
Length	179.1"
Height	52.1"
Width	69.1"
Tread: front/rear	56.6"/57.0"
Trunk or cargo volume (cu. ft.)*	10/32.6
Fuel capacity	15.4 gal.
Curb weight (lb.)**	2,787/2,838
Passenger capacity	4

*With rear seat down.
**Convertible curb weight 3,020 lb.



As part of Ford Motor Company's commitment to your total satisfaction, participating Ford Dealers offer the Free Lifetime Service Guarantee. They stand behind their work, in writing, for as long as you own your car. This guarantee covers virtually every repair you pay for after your new vehicle warranty expires. Now when you pay for a covered repair once, you never have to pay for the same repair again. Ever. The dealer who did the work will fix it free. Free parts. Free labor.

While it doesn't cover routine maintenance parts, belts, hoses, sheet metal or upholstery, this limited warranty does cover thousands of parts in normal use.

No other car company's dealers, foreign or domestic, offer this kind of security. Nobody.

See your participating Ford Dealer for details.



Ford Motor Company's optional Extended Service Plan covers major components on new Ford cars and light trucks for longer than the vehicle's basic warranty. The cost is so moderate for the protection you get that it could pay for itself the first time you need it. Your Ford Dealer will be happy to detail the plan for you. Available on all cars and most light trucks, it is honored by more than 6,100 Ford and Lincoln-Mercury dealers nationwide and in Canada.

Motorcraft QUALITY REPLACEMENT PARTS FROM FORD

Genuine Ford and Motorcraft original equipment replacement parts are precision engineered and manufactured to Ford specifications to deliver top-level performance in all Ford-built cars and trucks. The Ford and Motorcraft brand names are your best assurance of quality and long-term satisfaction because these replacement parts meet the same high standards as those installed in production, and at Ford, "Quality is Job 1."

Scheduled maintenance

Ford wants to reduce the frequency and cost of scheduled maintenance on its cars to an absolute minimum. Here are some examples of scheduled maintenance intervals for the 1985 Ford Mustang. For complete maintenance recommendations, refer to the Mustang Owner Guide.

Engine oil change	each 7,500 miles
Turbo	each 5,000 miles
Spark plug change	each 30,000 miles
Turbo	each 15,000 miles
Air filter replacement	each 30,000 miles
Engine coolant replacement	each 52,500 miles or 3 years on 2.3L Turbo, 3.8L V-6 and 5.0L V-8 engines; Each 50,000 miles or 3 years on 2.3L Turbo engines.

The commitment to quality by Ford and its dealers can save you money on repairs, too.

In addition to the Lifetime Service Guarantee, the Extended Service Plan and Ford and Motorcraft original equipment parts already described, Ford and Ford Dealers are working in other ways to save you money on repairs and help ensure your satisfaction.

Nationwide dealer network ready to assist you

Should your Ford car or truck need repair while you're traveling or away from home, the nearest servicing dealer can be located simply by calling one of the toll-free numbers listed under "Ford-paid repair programs."

Specialized tools and equipment

The latest in diagnostic and service equipment designed especially for use in the repair of Ford Motor Company products is available. This equipment helps the technician make the repair properly so you won't have to come back a second time.

Continued service technician training

Dealership technicians are continuously updated on the latest techniques and procedures to help them keep your Ford car or truck running at its best.

Ford-paid repair programs after the warranty period

Sometimes Ford offers adjustment programs to pay all or part of the cost of certain repairs. These programs are intended to assist owners and are in addition to the warranty or to required recalls. Ask Ford or your dealer about such programs relating to your Ford or Lincoln-Mercury vehicle.

To get copies of any adjustment program for your vehicle or the vehicle of interest to you: Call Ford toll-free at 1-800-241-3673. Alaska/Hawaii call 1-800-241-3711 and in Georgia call 1-800-282-0959.

Or write Ford at:

Ford Customer Information System
Post Office Box 95427
Atlanta, Georgia 30347

We'll need your name and address; year, make and model vehicle, as well as engine size; and whether you have a manual or automatic transmission.

Technical service bulletins

All vehicles need repairs during their lifetime. Sometimes Ford issues technical service bulletins (TSBs) and easy-to-read explanations describing unusual engine or transmission conditions which may lead to costly repairs, the recommended repairs, and new repair procedures. Often a repair now can prevent a more serious repair later. Ask Ford or your dealer for any such TSBs and explanations relating to your Ford or Lincoln-Mercury vehicle.

To get copies of these technical service bulletins and explanations for your vehicle or the vehicle of interest to you: Call Ford toll-free at 1-800-241-3673. Alaska/Hawaii call 1-800-241-3711 and in Georgia call 1-800-282-0959.

Or write Ford at:

Ford Customer Information System
Post Office Box 95427
Atlanta, Georgia 30347

We'll need your name and address; year, make and model vehicle, as well as engine size; and whether you have a manual or automatic transmission.

Options availability

Options shown or described in this catalog are available at extra cost and may be offered only in combination with other options or subject to additional ordering requirements or limitations. Your Ford Dealer has the latest information.

Product changes

Ford Division reserves the right to change product specifications at any time without incurring obligations.

"Ask your Ford Dealer"

Following publication of this catalog, certain changes in standard equipment, options, prices and the like, or product delays, may have occurred which would not be included in these pages. Your Ford Dealer is your best source for up-to-date information.

Have you driven
a Ford...lately?



FORD MUSTANG

