



2027

QX60



↓ SWIPE

Jump to a Section

Tap an arrow to skip to section

Design

Exterior, Interior, SPORT Trim,
Space & Cargo



Onboard Tech

Comfort & Convenience, Infotainment



Drive Tech & Performance

Driver Assist Technology, Performance



Style & Specs

Style, Specs, Trims



Accessories

Exterior, Interior, Cargo, Lighting & Tech,
Towing, Pet



Design

Exterior



Interior



SPORT Trim



Space & Cargo



Back to Menu



Build & Price →

QX60

Exterior

COMMANDING PRESENCE

Take On Life
in Style



BACK TO SECTION

COMMANDING PRESENCE

The 2027 INFINITI QX60 instantly captures attention – without calling for it. The exterior is marked by its bold stance. Refined lines and intricate details exude power and sophistication, creating a luxurious style that is impossible to ignore. In the artfully designed QX60, you'll make a statement without uttering a single word.



Refined body lines

COMMANDING PRESENCE

The 2027 QX60 has a striking, available **INFINITI Light Path** that illuminates the ground you walk on. Designed to enhance visibility and create a distinctive look, the precision-engineered LED lighting system infuses a sense of contemporary elegance.

INFINITI Light Path¹

COMMANDING PRESENCE

From the **Deep Emerald two-tone paint color**² to the available **dark exterior trim** and low-profile roof rails,^{1,3} everything about QX60 dials up the sophistication. What's more? The AUTOGRAPH trim's dark gray **20-inch wheels** have been designed with a sculptural double-wing, and are machine-surfaced, then topped with a tinted clear coat for visual depth.



Two-tone exterior paint²



Wheel arch moldings and 20" machined aluminum-alloy wheels with tinted clear coat¹



FRONT DESIGN CUES

Make an
Unforgettable
First Impression



FRONT DESIGN CUES

A lasting impression starts with a first impression. QX60 leads with its **double-arch waterfall grille**, featuring a bold and flowing design that integrates an **INFINITI Radiant[®] Illuminated Grille Emblem** to cast a subtle yet captivating glow. Flanking this centerpiece are the **signature Digital Piano Key headlights**, inspired by the intricate kimono-fold pattern, which combines advanced illumination technology with a touch of cultural artistry.



Double-arch waterfall grille and
INFINITI Radiant Illuminated Grille Emblem

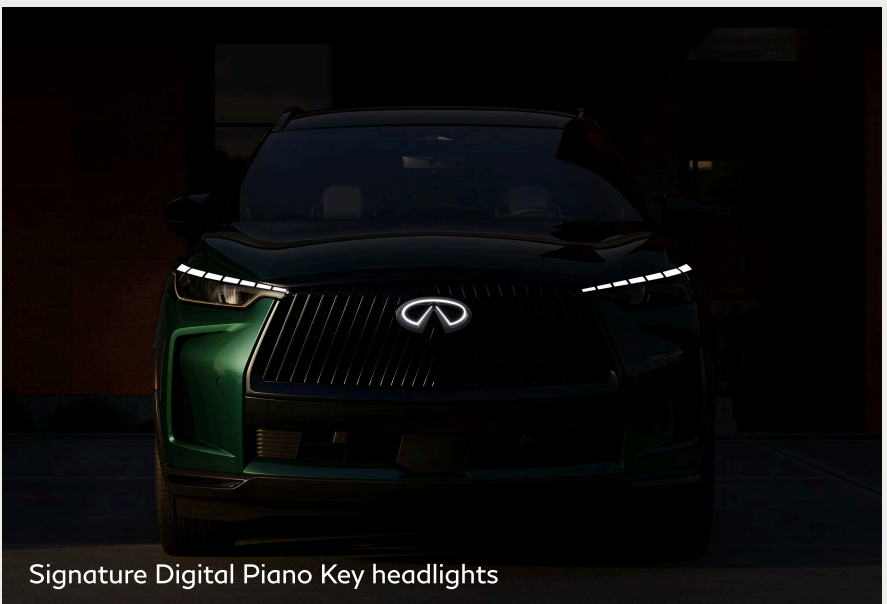

Signature Digital Piano Key headlights

FRONT DESIGN CUES

The **sculpted front bumper design** exudes strength and sophistication. Crafted with precision, the bumper seamlessly integrates with the vehicle's overall aesthetic, enhancing its dynamic presence. Subtle yet impactful design lines create a sense of motion even when the vehicle is stationary.



Sculpted front bumper design

QX60

Exterior

REAR DESIGN CUES

Style That Sets the Tone



REAR DESIGN CUES

Graceful exterior styling is what the QX60 does best. With a **clean, broad liftgate** and a **rear bumper design** that makes the SUV appear lower and wider, QX60 is the perfect mix of commanding and chic. Models with Intelligent All-Wheel Drive^{1, 20} have a beautiful AWD badge inspired by Japanese Hanko stamps.



Clean, broad liftgate design

REAR DESIGN CUES

The **Digital Piano Key lighting** of the QX60's taillights is one of its most distinctive qualities. The horizontal design wraps around and joins with a central garnish, giving it a wide, stable, plated appearance. Deep-set LEDs light each taillight segment with a uniform glow. Upon closer look, you'll notice the LEDs resemble the sparkly facets of a gem.



LED taillights



Digital Piano Key lighting

QX60

Interior

ENERGETIC COMFORT

Uncompromisingly
Modern



ENERGETIC COMFORT

The 2027 interior offers a blend of comfort and class. The **seamless center console** integrates essential controls into a clean, minimalist design, enhancing the cabin's sleek ambience. High-quality materials like **semi-aniline leather appointments**¹ and **metal inlaid accents**¹ create an inviting and well-crafted space. With spacious seating and meticulous attention to detail, the QX60 ensures every journey is enjoyed in supreme comfort and style.



Seamless center console with leather-accented shifter



Semi-aniline leather-appointed seats (first & second rows)¹

ENERGETIC COMFORT

Seamlessly integrated elements create enhanced aesthetics and functionality. The **integrated vents** meld effortlessly into the dashboard, maintaining a harmonious appearance, and **blacked-out haptic controls** respond precisely to touch for an interior as elevated as it is intuitive.



Integrated vents & blacked-out haptic controls

QX60

Interior



DESIGN INTRICACIES

Reward Your
Sense of Touch



DESIGN INTRICACIES

Soft-touch materials and precision stitching ensure every surface feels as good as it looks. Complementing these plush finishes is the **Open Pore Ash Wood with Metal Inlay accents¹** that add a touch of modern finesse.

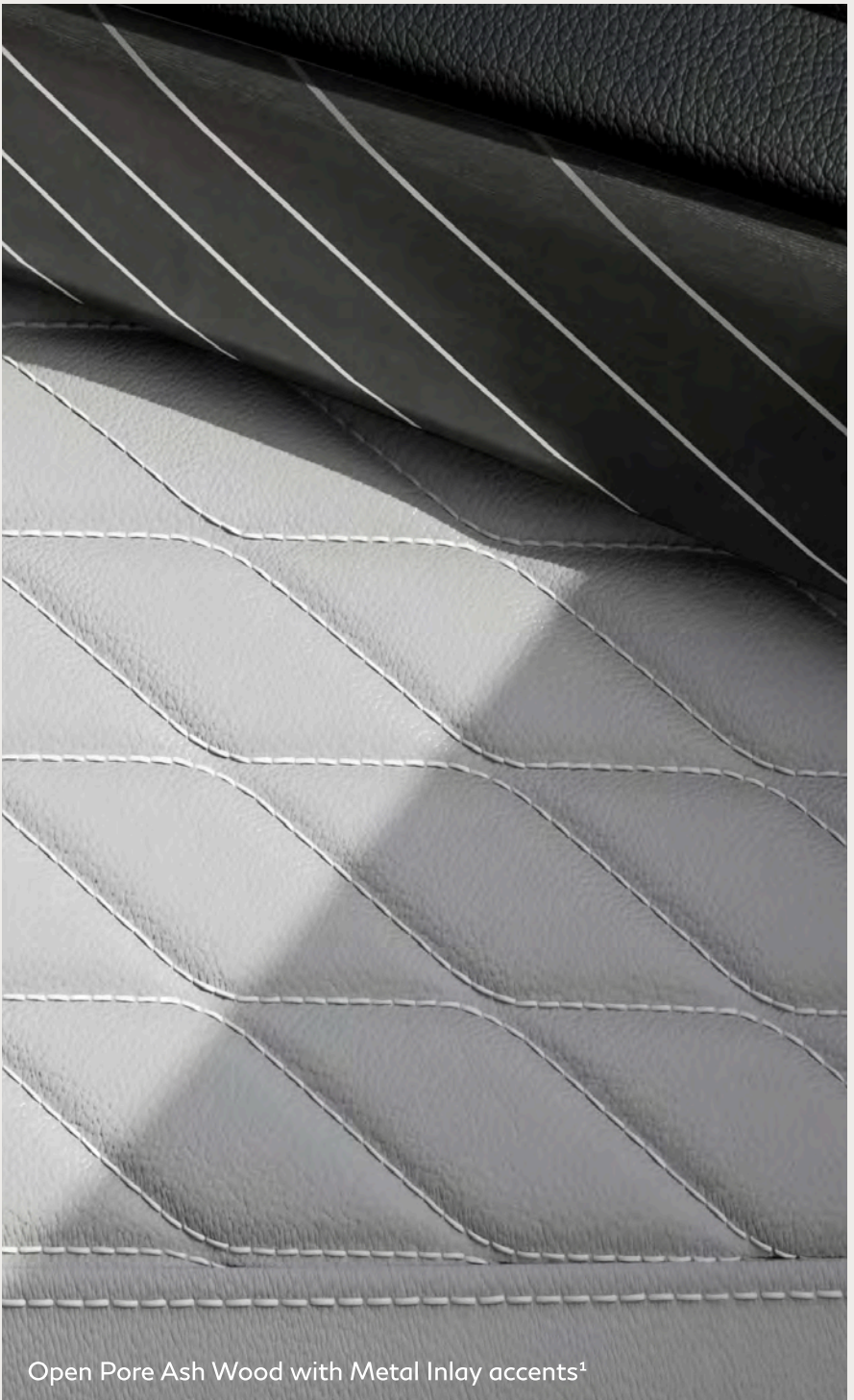

Open Pore Ash Wood with Metal Inlay accents¹

DESIGN INTRICACIES

Exquisite craftsmanship is reflected in the **contrast stitching** adorning the dash, center console, door panels and seats, adding depth and texture to every surface. The **two-tone Stone Gray semi-aniline leather-appointed seats with quilting** offer unparalleled comfort and style, underscoring the vehicle's commitment to high-quality materials and refined design.¹

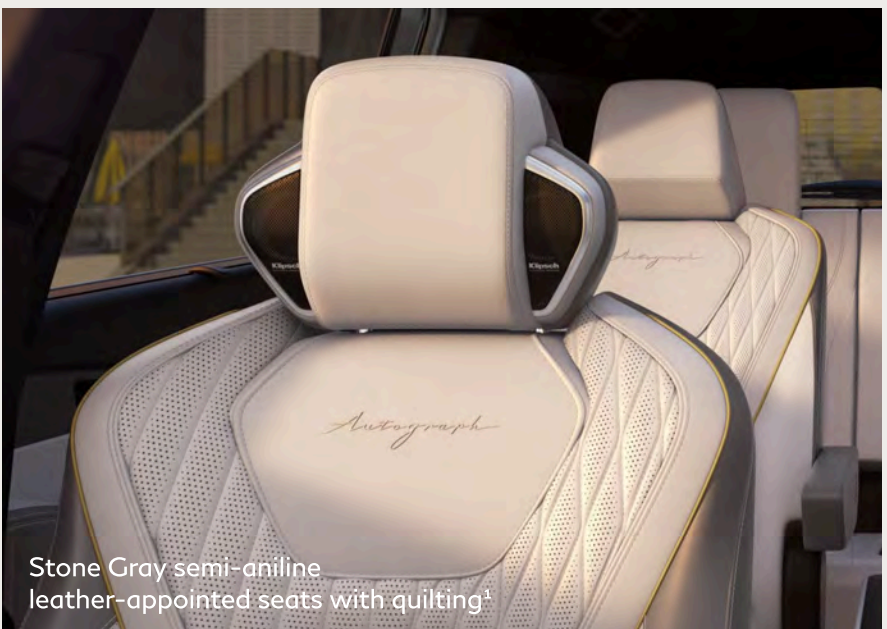

Contrast stitching

Stone Gray semi-aniline leather-appointed seats with quilting¹

DESIGN INTRICACIES

The **aluminum Klipsch® speaker grilles** incorporate a sense of unmistakable style.¹ These sleek, durable grilles ensure premium sound quality and enhance the vehicle's aesthetic appeal, seamlessly blending with the refined cabin design.



Aluminum Klipsch® speaker grilles¹

QX60

SPORT Trim

DESIGN EXPRESSION

The Art of Sport



EXTERIOR EXPRESSION

Our SPORT trim elevates style and performance to new heights. The **gloss black 20-inch aluminum-alloy wheels** have a unique design and finish that ensure this trim stands apart. The distinct **front lower fascia** and **exclusive grille mesh design** add a touch of aggression and refinement. **Dark exterior accents** and **gloss black body-side moldings** further enhance the vehicle's athletic appeal, while an **"S" badge** on the liftgate and sleek **black roof rails** complete the look.³ For those seeking an even edgier QX60, the SPORT trim is also available with a **two-tone Black Obsidian roof** for an even more striking contrast.

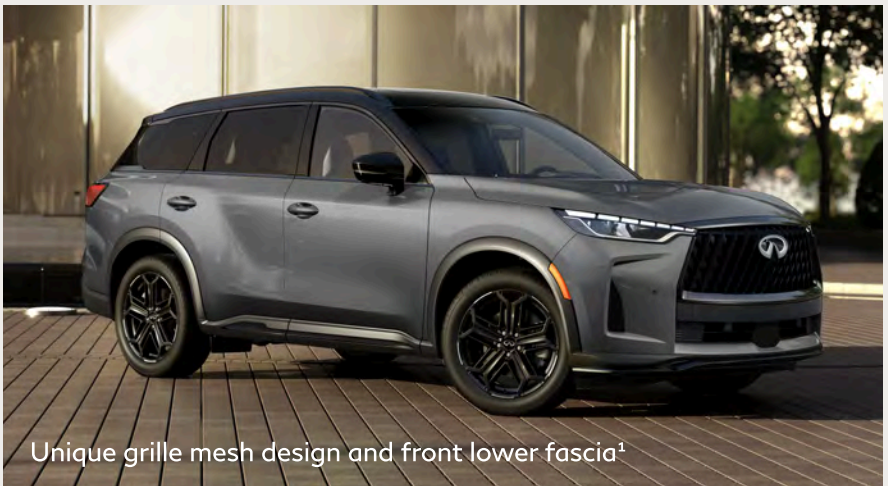

Unique grille mesh design and front lower fascia¹

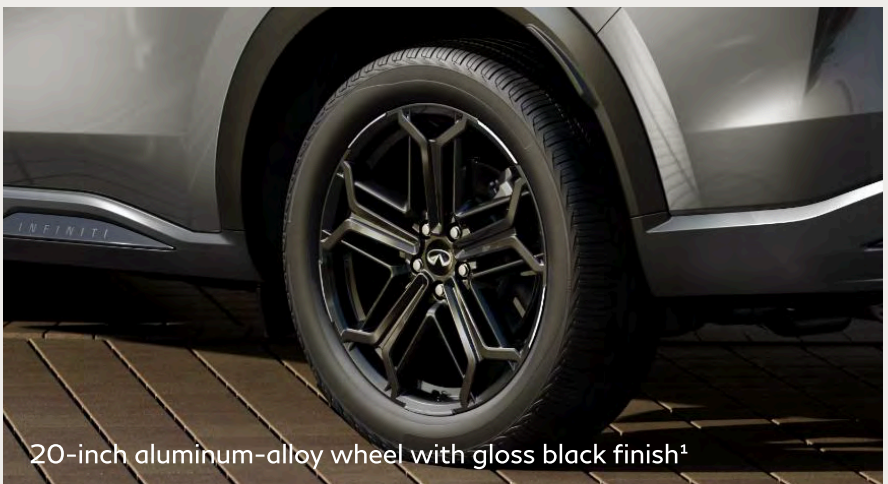

20-inch aluminum-alloy wheel with gloss black finish¹

INTERIOR EXPRESSION

The sleek interior of the 2027 SPORT trim says, "I'm not afraid to do things my way." It features rich, **Graphite** or **two-tone Dusk Blue TailorFit®-appointed seats** with **captain's chairs for the second row**, or optional bench seating. The exquisite **Silver Metallic Weave interior trim** and **black headliner** gives it an even greater sense of cool.



Unique Dusk Blue TailorFit®-appointed interior and captain's chairs¹



Silver Metallic Weave interior trim¹

QX60

Space & Cargo

SPACIOUS INTERIOR

Curate Your Cargo



SPACIOUS INTERIOR

QX60 is designed with families and large groups in mind, offering comfortable seating for up to **seven passengers**. The comfortable, standard **second-row bench seat** provides ample space, while the **theater-style seating** ensures everyone enjoys an elevated and clear view. The **six-passenger seating** option features **second-row captain's chairs with a center console** for added comfort and convenience.¹



Seven-passenger seating with second-row bench seating



Six-passenger seating with second-row captain's chairs¹

SPACIOUS INTERIOR

In either configuration, the standard **panoramic moonroof** stretches across the roofline, filling the cabin with natural light and creating an open, airy atmosphere. Full hands? No problem. The **multi-mode second-row seat** with tilt and slide functionality and **one-touch release** provides easy access to the third row, making it simple to accommodate both passengers and cargo.^{3,4}



Panoramic moonroof

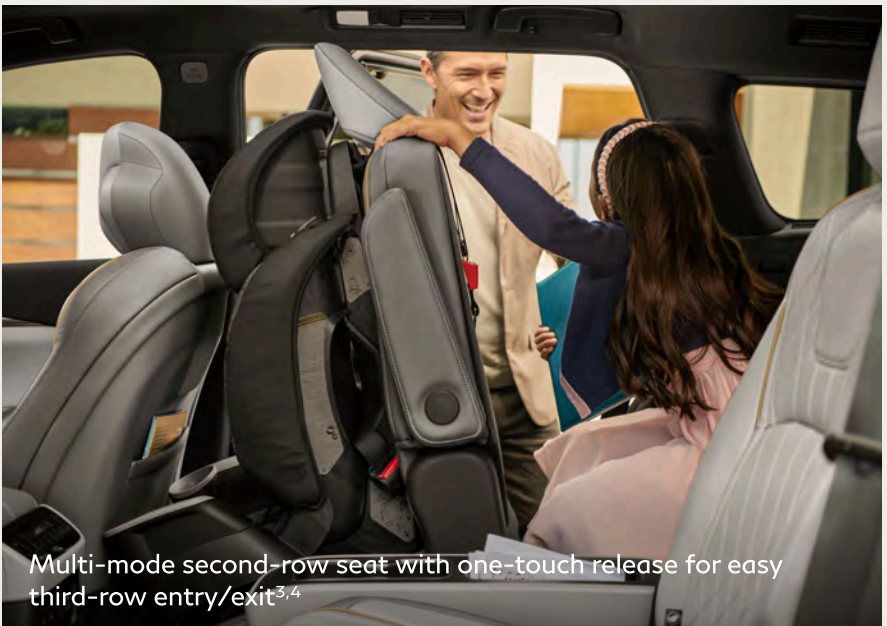

Multi-mode second-row seat with one-touch release for easy third-row entry/exit^{3,4}

SPACIOUS INTERIOR

Simplify your daily routine. With a swift kicking motion under the center of the rear bumper, the **Motion-Activated Liftgate** opens up to the cargo space, allowing easy access even when your hands are full.¹ Then, expand the space to suit your needs. A spacious **75.4 cubic feet of storage space** when the second and third rows are folded flat makes every errand and adventure seamless and enjoyable.³



SPACIOUS INTERIOR

The **versatile seating configurations** and available **third-row seatback power return**, allow you to easily adjust between passenger and cargo space.^{1,5} The 53-liter **underfloor storage compartment** provides an additional, discreet space for smaller items, keeping the cargo area organized on everyday errands and weekend excursions.



Available third-row seatback power return^{1,5}

Onboard Tech

Comfort & Convenience



Infotainment



Back to Menu



Build & Price →

QX60

Comfort & Convenience

INTERIOR COMFORT

Designed for Your
Always-On Life



BACK TO SECTION

INTERIOR COMFORT

Think of your drive home from a busy day as a reservation for relaxation. **Zero Gravity front seats** can help reduce fatigue in long drives, and the **massaging function** creates a more refreshing ride for the driver and front passenger alike.¹



Zero Gravity front seats with massage function¹

INTERIOR COMFORT

Breathe deeply knowing that the **Advanced Climate Control System**, featuring a **Plasmacluster® air purifier**, **auto-recirculation** and **Grape Polyphenol filter**, not only maintains optimal cabin temperature but also collects and helps neutralize dirt, pollen and dust for fresher air in the cabin.^{1,6}



Advanced Climate Control System^{1,6}

INTERIOR COMFORT

Stay comfortable in every season with **heated and ventilated, climate-controlled front seats**,¹ a standard **heated steering wheel** and **heated outboard second-row seats**¹ for passenger warmth. Additionally, enjoy privacy and protection from the sun with the available **rear-passenger manual sunshades**.¹

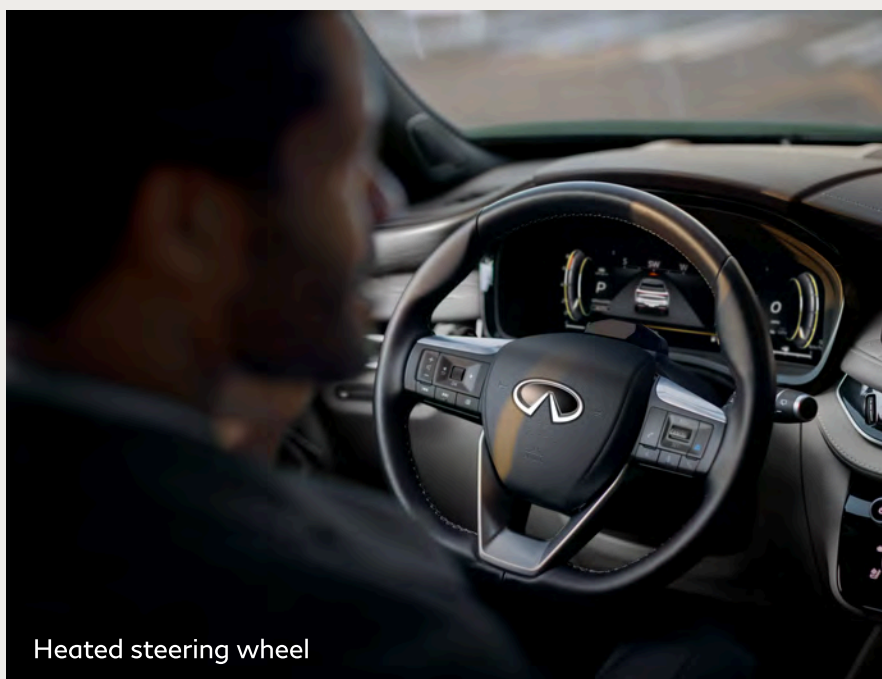

Heated steering wheel



Heated second-row seats and manual sunshades¹

QX60

Comfort & Convenience



FORWARD-THINKING FEATURES

Bring Focus Back
to What Matters



FORWARD-THINKING FEATURES

Your QX60 gets to know you and your specific tastes. The **Intelligent Key** automatically signals the vehicle to personalize as you enter. Easily control your vehicle's locks from a distance with the **approach unlock & walk away lock**. Before you even leave your front door, you can use **Remote Engine Start** to warm up or cool down your vehicle for your drive.^{1,7}



Approach unlock & walk away lock

FORWARD-THINKING FEATURES

With **acoustic laminated front-row window glass**, strategic placement of advanced sound absorption materials and **Active Noise Cancellation**, the QX60 makes for a peaceful drive. You'll hear less road, wind and engine noises and be able to enjoy conversations between the first and third rows, even at highway speeds – it's just lovely.

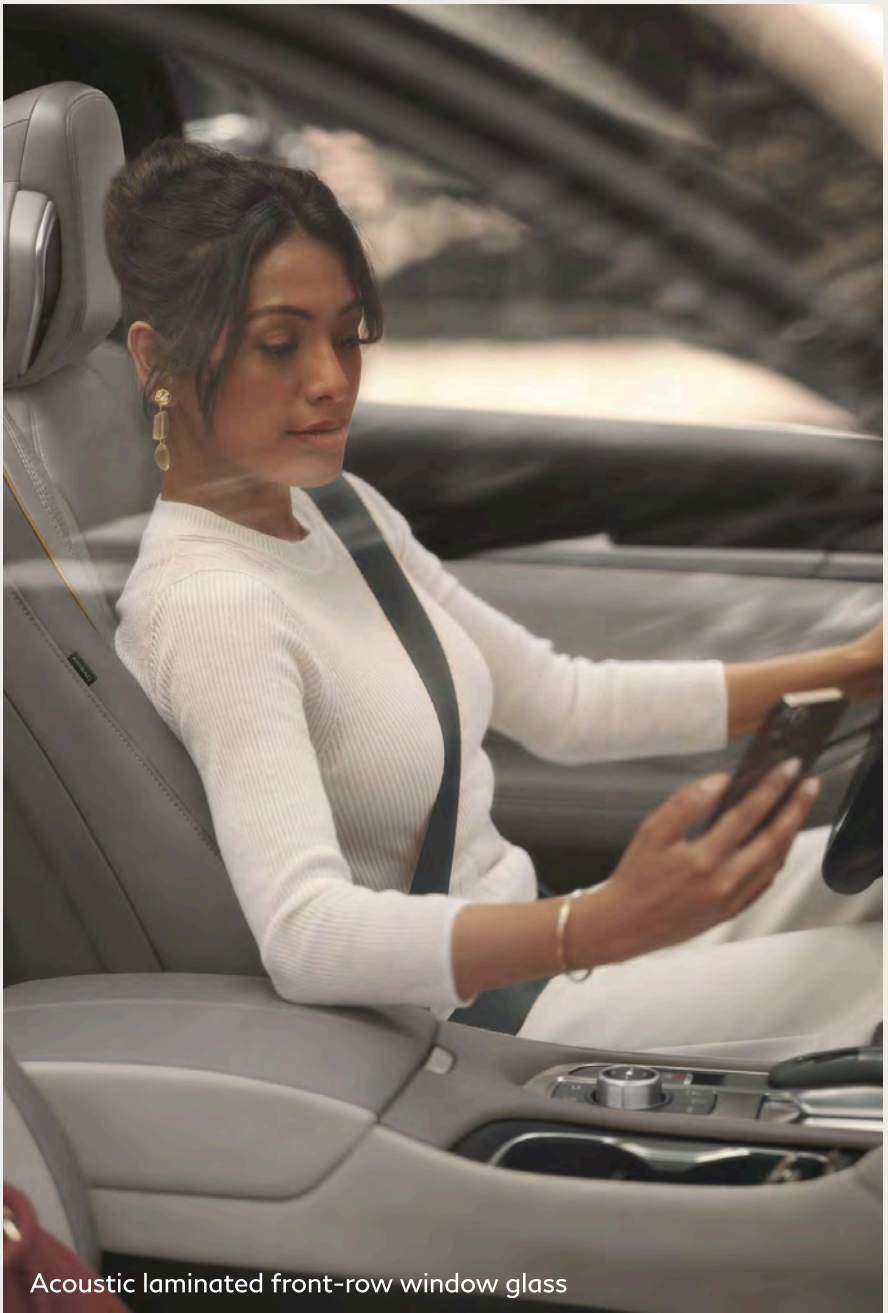

Acoustic laminated front-row window glass

INTERIOR TECHNOLOGY

Do More With Your Drive Time

Massage Settings



Relaxing

Intensity
Speed

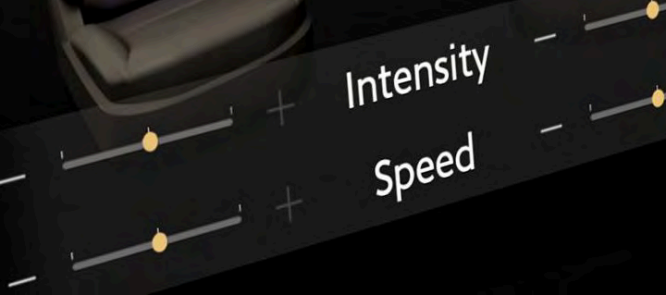

INTERIOR TECHNOLOGY

Find the information you need, where you need it. Standard **dual displays**, including the **INFINITI 12.3" Dynamic Meter Display** and **INFINITI InTouch® 12.3" Interactive Display**, provide clear and intuitive access to vehicle information and entertainment.^{8,9} Additionally, the available **10.8" Head-Up Display** projects key information directly onto the windshield, helping you stay informed and focused on the road.¹⁰



INFINITI InTouch® 12.3" Interactive Display⁸



INFINITI 12.3" Dynamic Meter Display⁹ and Head-Up Display^{1,10}

INTERIOR TECHNOLOGY

Sometimes, you want a podcast to stimulate your creativity. Other times, it's a playlist to set the vibe. No matter your mood, the available **20-speaker Klipsch® Reference Premiere Audio System with Individual Audio** delivers an immersive listening experience with exceptional clarity and depth. **Individual Audio** isolates phone calls, texts and navigation to the speakers in the driver's headrest, while entertainment like music and podcasts continue to play for the rest of the cabin.^{1,11,12,13}



INTERIOR TECHNOLOGY

Your life is busy, so QX60 technology helps you stay connected while on the go. **Google built-in** offers seamless access to Google Maps for available navigation, Google Assistant for hands-free voice control and the Google Play store for downloading your preferred apps.^{8,13,14}



Google built-in^{8,14}

GOOGLE BUILT-IN

Just Ask Google

**GOOGLE MAPS**

Becomes your built-in navigation system and integrates across displays so you stay connected and up-to date^{8,13,14}

**GOOGLE ASSISTANT**

Bring Google into your QX60 as a vocal copilot that continuously learns as you use it. Control vehicle functions like the seats, heated steering wheel, climate control and more – just say, "Hey Google"^{8,14}

**GOOGLE PLAY**

Includes apps for music, video and messaging, plus – in-park apps like Pluto, Fubo, Prime, and HBO Max are now available to download^{8,12,14}

INFINITI INTOUCH®

Keep Everyone Connected and Entertained

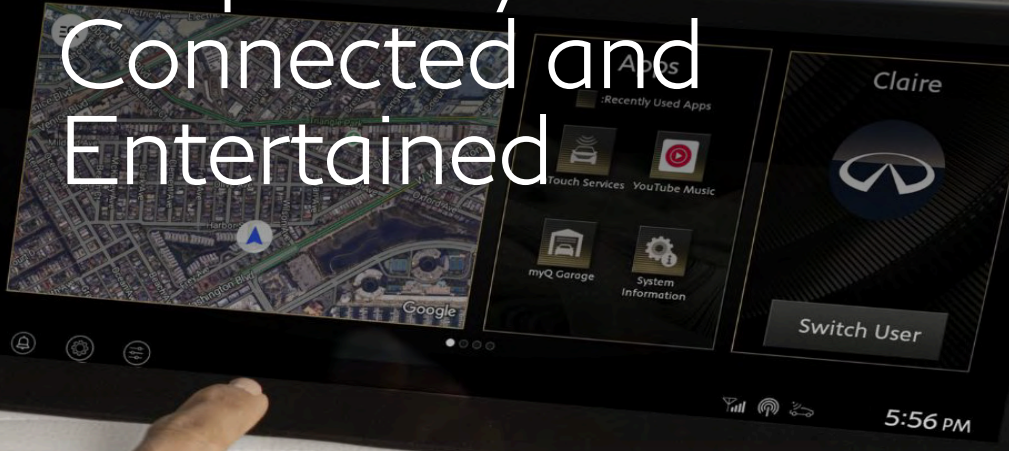

INFINITI INTOUCH®

With **INFINITI InTouch® Services**, the available **MyINFINITI app** and a **5G Wi-Fi Hotspot** for up to seven devices, your whole crew can stay connected. Even QX60 enjoys the connection with **over-the-air updates** for vehicle systems.^{8,15,16,17}

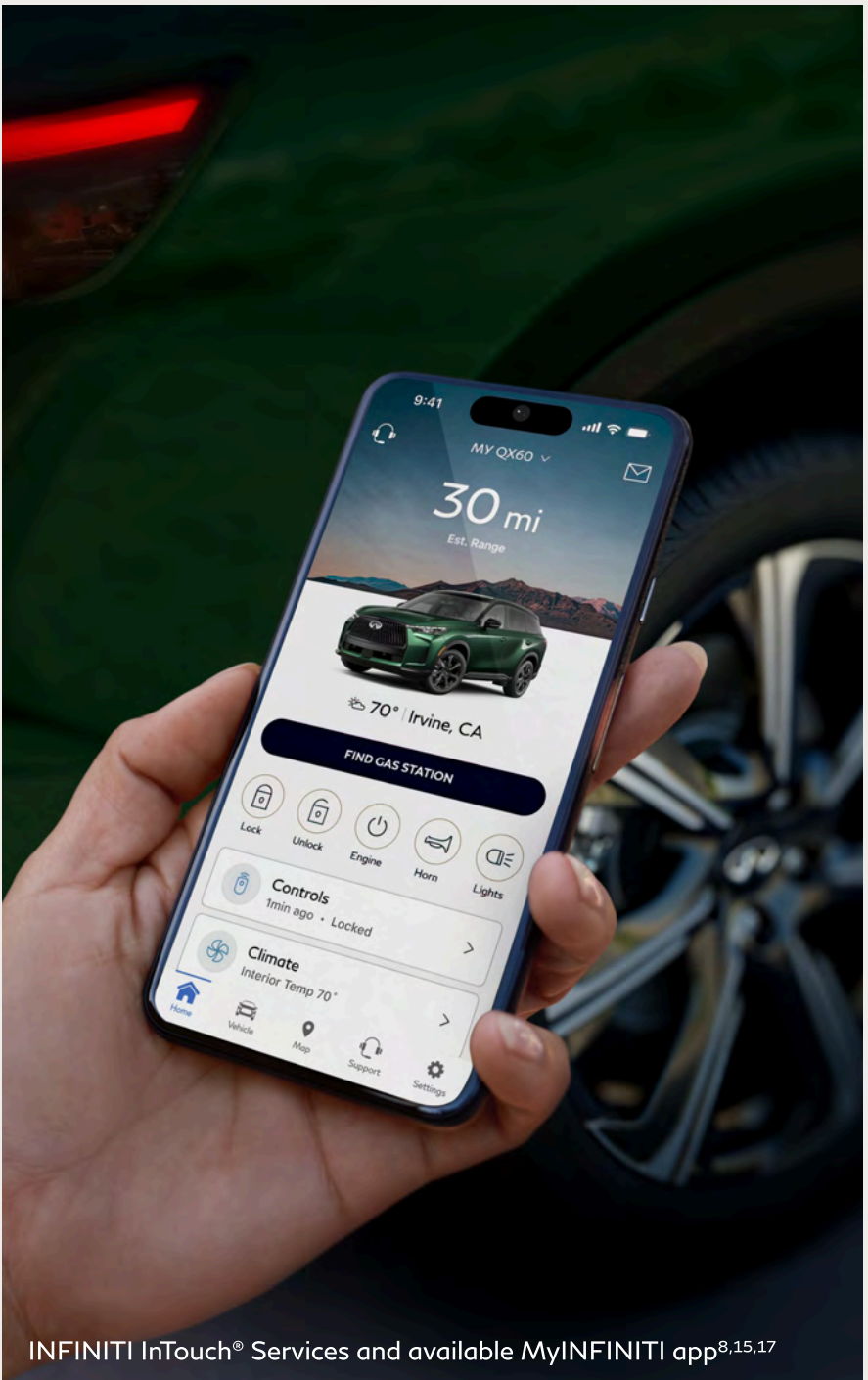

INFINITI InTouch® Services and available MyINFINITI app^{8,15,17}

INFINITI INTOUCH®

Enjoy a personalized audio experience that connects to who you are. With **360L by SiriusXM®**, get ad-free Pandora® stations tailored to you. Our intelligent personalization engine curates audio recommendations based on your listening history and favorite selections. From Ignition On Recommendations that greet you with curated content to Spotlight Recommendations that introduce fresh music, every drive is tailored to your taste. Even create individual listener profiles for each passenger, discover similar content with the new Related button, and access Xtra Channels and Voice Search for on-demand control.¹⁸

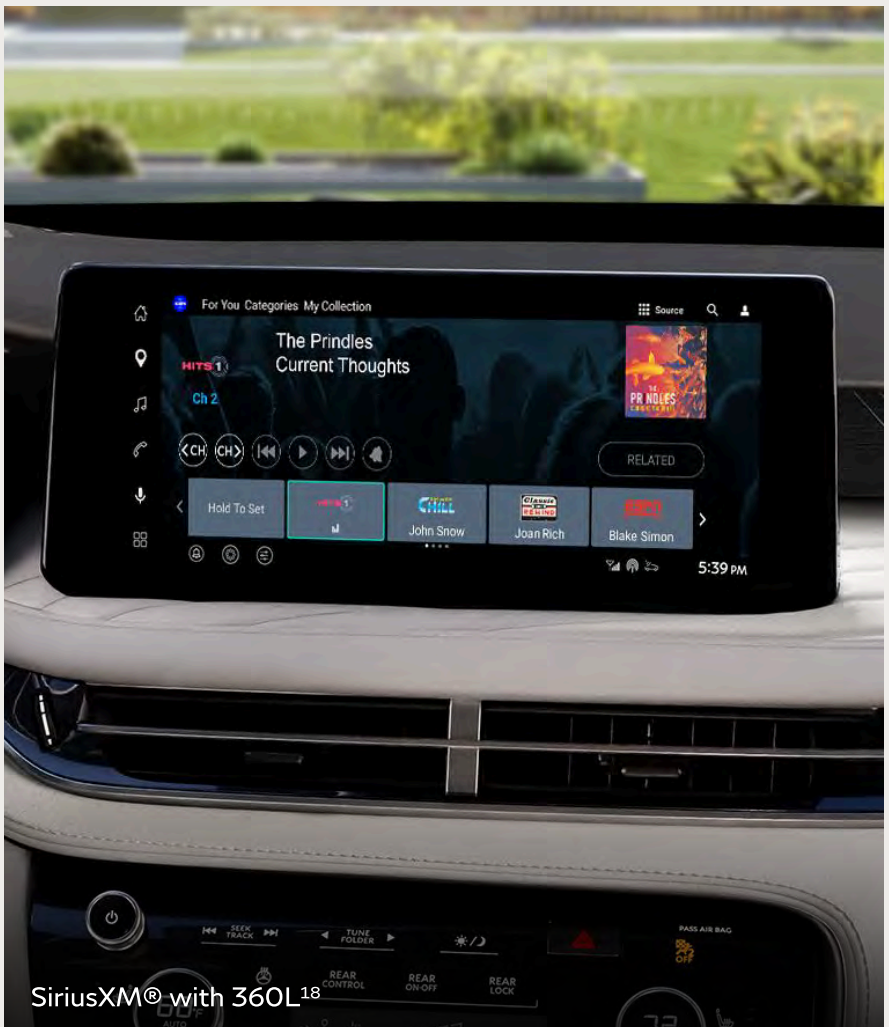



CONNECTIVITY

Tech That Syncs All of Your Worlds



CONNECTIVITY

The world of iPhone® is conveniently located on the display of your QX60. Use **wireless Apple CarPlay®** with a compatible iPhone® to stay connected and enjoy hands-free and intuitive touchscreen access to apps like music, navigation, news and more.^{8,13,15}



Wireless CarPlay® integration^{8,15}

CONNECTIVITY

Your life is multifaceted, and so is the QX60. With **wireless Android Auto™**, you can connect your compatible Android™ device and enjoy hands-free and intuitive touchscreen access to your apps, music, navigation and more – all without the need for cumbersome cables and messy wires.^{8,13,15}



CONNECTIVITY

Powering your life starts with powering your devices, and QX60 provides options. The new, industry-leading **Qi2® wireless charging pad** with magnetic alignment holds your device perfectly in place, elevating it to protect your cameras and creating optimal contact for charging. 15W fast charging significantly reduces charge time compared to common 5W chargers, while active cooling maintains the ideal temperature for continuous, efficient charging. Additionally, there are **4 standard charging ports**, an available **USB-C charging port** for the third row, and a **120V power outlet** exclusively for the AUTOGRAPH trim.^{15,19}



Wireless charging pad¹⁵



Illuminated USB-C ports^{15,20}

Drive Tech & Performance

Driver Assist Technology



Performance



Back to Menu



Build & Price →

QX60

Driver Assist Technology

DRIVER ASSIST FEATURES

Commute With Assistance



BACK TO SECTION

DRIVER ASSIST FEATURES

Experience the boosted convenience of ProPILOT Assist technology. **ProPILOT Assist** provides hands-on assistance for a smoother highway driving experience, including adaptive **Intelligent Cruise Control with stop-and-go** functionality and **Steering Assist**, which helps keep you centered in your lane.^{1,20} Available on AUTOGRAPH grade, **ProPILOT Assist 2.1** further advances this technology with **hands-off driving** capabilities (under certain conditions), hands-on **Lane Change Assist** and **Passing Assist** features.^{1,20,21}



ProPILOT Assist^{1,20}



ProPILOT Assist 2.1^{1,21}

QX60

Driver Assist Technology

VISIBILITY FEATURES

See All Sides of Your
INFINITI



VISIBILITY FEATURES

An available **3D Around View® Monitor with Moving Object Detection** grants you a 360-degree view of the area around you in a detailed 3D perspective.^{20,22} The nearly **180-degree Front Wide View camera** shows what's around the corner without needing to pull forward.^{1,20} Or, if you need to see what's under you, the **Invisible Hood View**^{1,20} sees directly under QX60 while in motion, and visualizes the curb, the track at the car wash or a runaway soccer ball on the display.^{1,20}

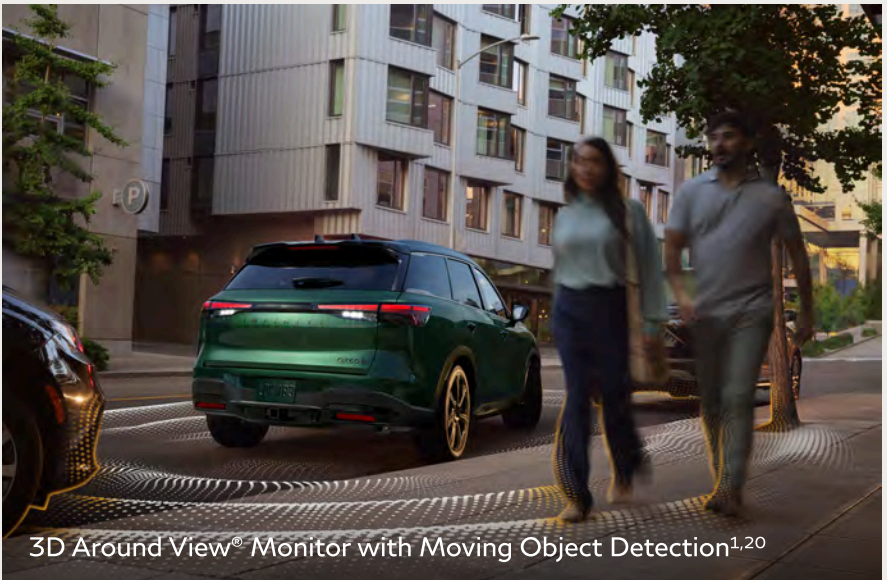

3D Around View® Monitor with Moving Object Detection^{1,20}



Front Wide View²⁰

VISIBILITY FEATURES

With a flick of the toggle, you can change your available **Smart RearView Mirror** to a wide-angle monitor for an unobstructed digital view of the road behind you. Seamlessly switch between a traditional mirror and high-resolution camera feed for clear visibility, even when passengers or cargo block the rear window.²⁰



QX60

Driver Assist Technology



DRIVER ASSIST FEATURES

Helping Sense
the Unseen



DRIVER ASSIST FEATURES

Maintain a clear view of the road ahead with **High Beam Assist**. It adjusts automatically between high and low beams based on oncoming vehicles, so you can use your high beams when needed without dazing other drivers. And with the **Driver Attention Alert**, QX60 notifies the driver if decreased attention is detected.¹



High Beam Assist

ADDITIONAL DRIVER ASSIST FEATURES

Vigilance in Action

**PREDICTIVE FORWARD COLLISION WARNING**

Can alert you of a potential collision up to two cars ahead²⁰

**FORWARD EMERGENCY BRAKING WITH PEDESTRIAN DETECTION**

Helps watch for vehicles and pedestrians in your path, and if detected, can apply the brakes²⁰

**LANE DEPARTURE PREVENTION**

Constantly monitors lane markings and can help guide you back if you unintentionally begin to drift²⁰

**BLIND SPOT INTERVENTION®**

Helps alert the driver to vehicles detected in the blind spot area and actively assists you back toward the center of your lane^{1,20}

**REAR CROSS TRAFFIC ALERT**

Uses sensors when backing up to detect approaching vehicles from either side and alerts the driver²⁰

**REAR AUTOMATIC BRAKING**

Can help apply the brakes if large stationary objects are detected behind you²⁰

QX60

Performance



PERCEPTIVE PERFORMANCE

Command
the On-Ramp



PERCEPTIVE PERFORMANCE

The QX60 is equipped with a **VC-Turbo® engine** and a **9-speed automatic transmission with paddle shifters**, so you're properly geared up for different needs. Whether you're merging, passing or cruising, the engine's power and efficiency are always ready to make smooth and quick shifts and never leave you waiting. QX60 even learns your driving style, so its shifting ability is tailored to you.²³

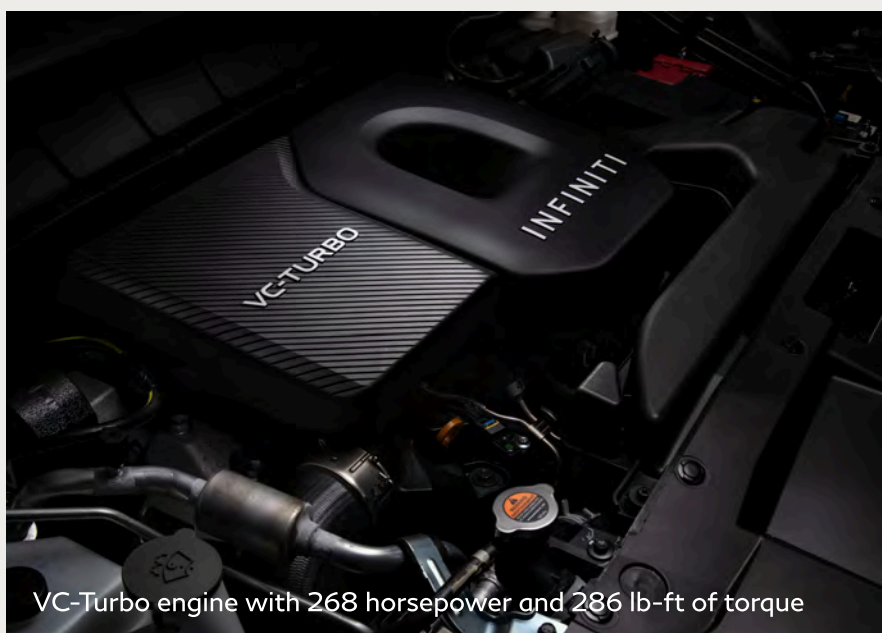

VC-Turbo engine with 268 horsepower and 286 lb-ft of torque



9-speed automatic transmission with paddle shifters

QX60

Performance

PERFORMANCE CAPABILITIES

Move With
Confidence



PERFORMANCE CAPABILITIES

Your day is in constant flow, so you need a vehicle that can match your every move. Available **INFINITI Intelligent All-Wheel Drive** helps you adapt to the conditions of the road at any moment.²⁰ And with five different **Drive Modes** to select from, you're ready for almost any situation. In the QX60, you'll pivot from one appointment to the next with purposeful precision.

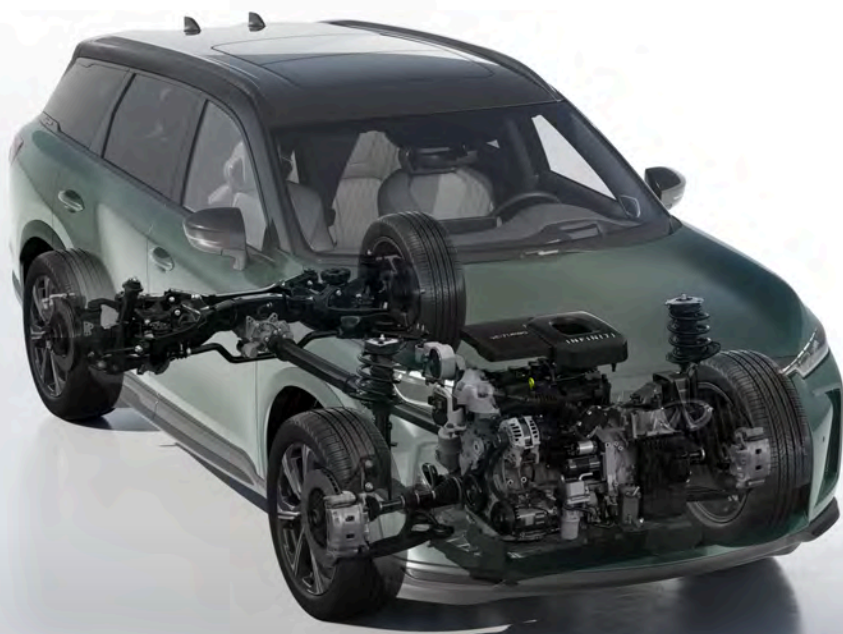

PERFORMANCE CAPABILITIES

Pull your most precious cargo. With a maximum tow rating of **up to 6,000 lbs.** when properly equipped and available **trailer sway control**, you can tow what you need with comfort and confidence. Class III towing hardware comes standard on the QX60 AUTOGRAPH trim, while the PURE, LUXE and SPORT trims are compatible with a Class II Genuine INFINITI Accessory **Tow Hitch Receiver** (sold separately).²⁴



Up to 6,000 lbs. max towing capacity²⁴

Style & Specs

Style



Specs



Trims



Back to Menu



Build & Price →



Deep Emerald*



Mineral Black*



Graphite Shadow



Warm Titanium*



Moonbow Blue*



Black Obsidian



Grand Blue*



Radiant White*



Harbor Gray*

INFINITI has taken care to ensure that the digital color swatches presented here are the closest possible representation of actual vehicle colors. Swatches may vary slightly due to viewing light or screen quality. Please see the actual vehicle and colors at your retailer. *Extra cost option. LIMITED AVAILABILITY. Contact your local retailer for inventory information.

INTERIORS 1 OF 2



Graphite TailorFit® (PURE / LUXE)



Stone Gray TailorFit® (PURE / LUXE)

INFINITI has taken care to ensure that the digital color swatches presented here are the closest possible representation of actual vehicle colors. Swatches may vary slightly due to viewing light or screen quality. Please see the actual vehicle and colors at your retailer.

INTERIORS 2 OF 3



Dusk Blue TailorFit® (SPORT)



Graphite TailorFit® (SPORT)

INFINITI has taken care to ensure that the digital color swatches presented here are the closest possible representation of actual vehicle colors. Swatches may vary slightly due to viewing light or screen quality. Please see the actual vehicle and colors at your retailer.

INTERIORS 3 OF 3



Graphite Semi-aniline Leather appointments (AUTOGRAPH)



Stone Gray Semi-aniline Leather appointments (AUTOGRAPH)



Saddle Brown Semi-aniline Leather appointments (AUTOGRAPH)

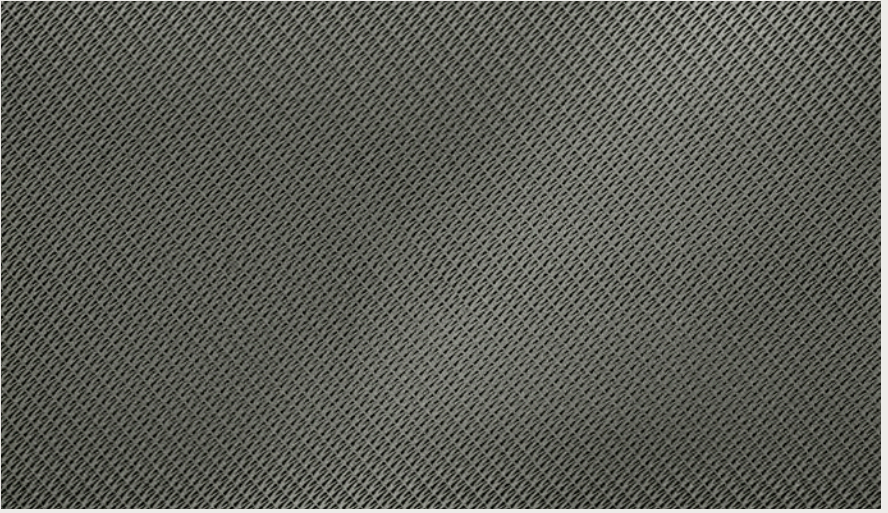

Silver Metallic Weave interior trim (PURE / LUXE / SPORT)

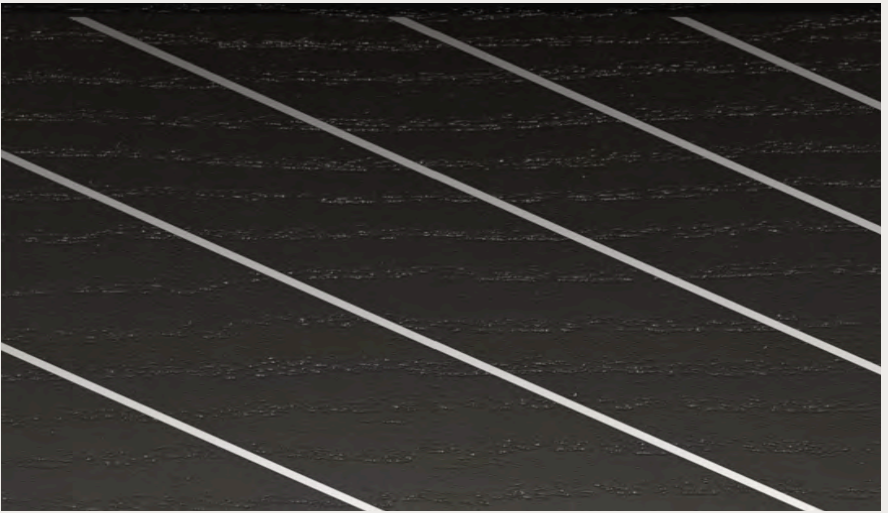

Open Pore Ash Wood interior trim with Metal Inlay (AUTOGRAPH)



18-inch machined aluminum-alloy wheels with charcoal metallic finish (PURE)



20" machined aluminum-alloy wheels with dark silver finish (LUXE)



20" aluminum-alloy wheels with gloss black finish (SPORT)



20" machined aluminum-alloy wheels with dark gray finish and tinted clear coat (AUTOGRAPH)

INTERIOR DIMENSIONS

Head room – first row / second row /
third row (inches)
41.0 / 37.5 / 35.7

Leg room – first row / second row / third row
(inches)
42.1 / 37.7 / 28.0

CAPACITIES

Seating
6¹ or 7 passengers

Interior passenger volume (cubic feet)
140.6

Cargo volume³ – second and third rows folded flat
(cubic feet)
75.4

Maximum tow capacity²⁴
Up to 6,000 lbs. standard, when properly equipped

Fuel tank
18.5 gallons

POWER & FUEL ECONOMY

Horsepower

268 hp @ 5,600 rpm

Torque

286 lb-ft @ 4,400 rpm

Estimated fuel economy FWD²³ – city / highway /
combined (mpg)22 / 28 / 24

Estimated fuel economy AWD²³ – city / highway /
combined (mpg)

21 / 27 / 24

EXTERIOR DIMENSIONS

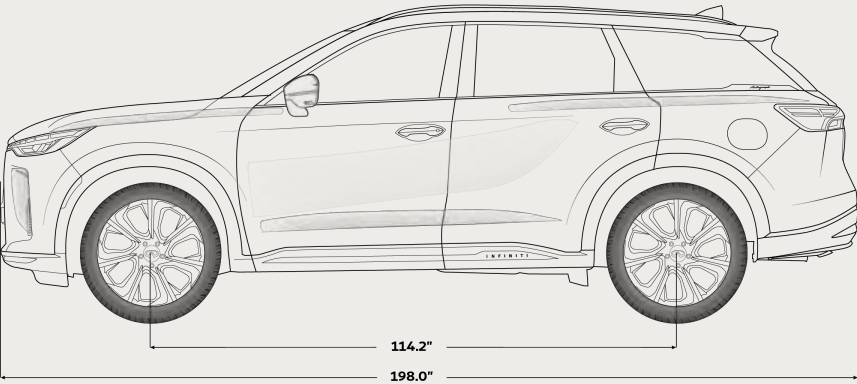
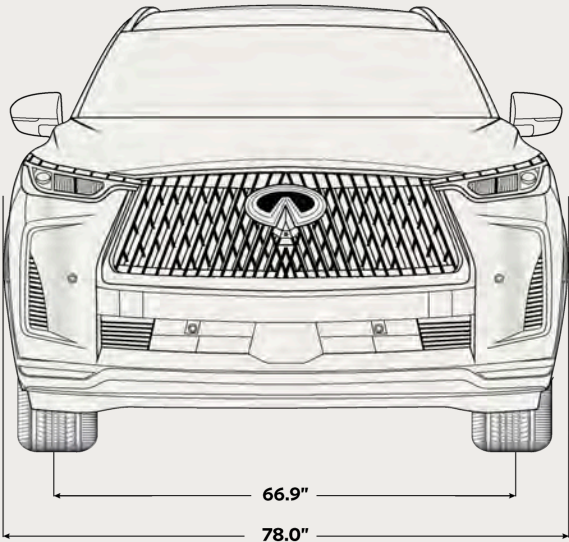

All dimensions are measured in inches.

EXTERIOR DIMENSIONS

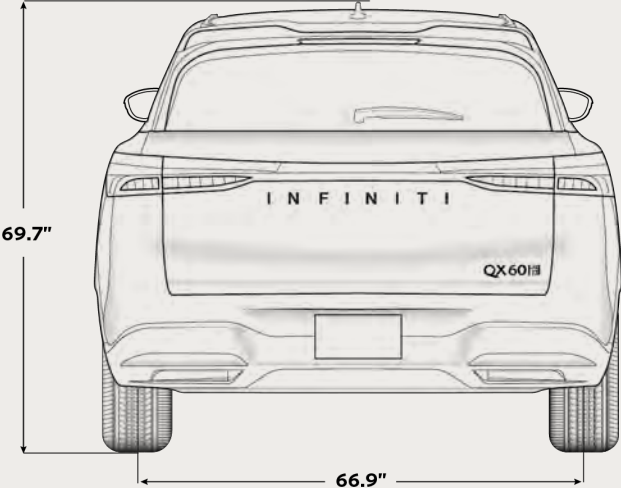

All dimensions are measured in inches.



QX60 PURE
The 2027 QX60



QX60 LUXE
Enhanced Convenience and Driver Assistance Features



QX60 SPORT
A Balance of Performance and Aesthetics





QX60 AUTOGRAPH
For the Consummate Host



QX60

PURE



Build & Price →



PURE 1 OF 7**MECHANICAL & PERFORMANCE**

2.0L VC-Turbo® 4-cylinder engine
(268 hp, 286 lb-ft of torque)

Idle stop/start

9-speed automatic transmission with manual shift mode

Paddle shifters

Front-Wheel Drive or INFINITI Intelligent All-Wheel Drive²⁰

Drive Mode Selector

13.78-inch front ventilated disc brakes / 12.99-inch rear ventilated disc brakes

Independent strut front suspension

Independent multi-link rear suspension

Electric Power Steering

EXTERIOR

18-inch machined aluminum-alloy wheels with charcoal metallic finish

255/60R18 all-season tires

PURE 2 OF 7

INFINITI Radiant® Illuminated Grille Emblem

LED automatic on/off headlights

LED signature Daytime Running Lights

LED taillights

Matte Chrome Window Surrounds

Matte black body side moldings

Panoramic moonroof with power open/close/tilt and sunshade

Acoustic front-row window glass

Rear privacy glass

Power adjustable, auto-fold & heated door mirrors with integrated turn signals, tilt reverse sync & puddle lamps

Body-color door handles with capacitive touch sensors on front handles

COMFORT & CONVENIENCE

7 passenger seating capacity

TailorFit® seats (first & second rows)

Leather-wrapped steering wheel

PURE 3 OF 7

Leather-accented shifter

Silver Metallic Weave interior trim

8-way power adjustable front seats

4-way driver and 2-way front-passenger power lumbar

60:40-split folding, sliding and reclining second-row bench seat

Multi-mode second-row seat with one-touch release for easy third-row entry/exit^{3,4}

60:40-split folding third-row seat with manual recline²⁶

2-driver memory system for driver's seat and outside mirrors

Heated front seats and steering wheel

Tilting and telescoping steering column

Tri-Zone Automatic Temperature Control System with microfilter

Rear air vents: headliner-mounted, second- & third-row outboard positions

Rear heater ducts: under first-row seats & on third-row passenger-side lower trim panel

PURE 4 OF 7

Rear Door Alert²⁵

Intelligent Key with push button ignition

Approach unlock & walk away lock

Electronic parking brake with Auto Hold

Hill start assist

Frameless auto-dimming rearview mirror

Rain-sensing front windshield wipers

Power rear liftgate

INFOTAINMENT

INFINITI 12.3-inch Dynamic Meter Display⁹

INFINITI InTouch[®] 12.3-inch Interactive Display⁸

Google built-in^{8,14}

INFINITI InTouch[®] Package with 3-year trial access⁸

Wi-Fi Hotspot⁸

Wireless CarPlay[®] integration⁸

Wireless Android Auto[™] compatibility⁸

PURE 5 OF 7

Bluetooth® Hands-free Phone System with audio streaming⁸

Advanced Voice Recognition

HD Radio® Technology

SiriusXM® with 360L with 3-month subscription included¹⁸

9-speaker audio system with AM/FM radio

Active Noise Cancellation

Advanced Voice Recognition

Wireless charging pad¹⁵

DRIVER ASSISTANCE

Cruise control

Predictive Forward Collision Warning²⁰

Forward Emergency Braking with Pedestrian Detection²⁰

Lane Departure Warning with haptic steering wheel feedback²⁰

Lane Departure Prevention²⁰

PURE 6 OF 7

Blind Spot Warning²⁰

Intersection Assist²⁰

Rear Cross Traffic Alert²⁰

Rear Automatic Braking²⁰

Rear parking sensors²⁰

RearView Monitor²⁰

High Beam Assist

SAFETY

INFINITI Advanced Air Bag System includes dual-stage front air bags with seat belt sensors and an occupant-classification sensor²⁷

Driver and front-passenger supplemental knee air bags²⁷

Driver and front-passenger seat-mounted side-impact supplemental air bags for outboard occupants²⁷

Roof-mounted curtain supplemental air bags for side-impact and rollover head protection for outboard occupants²⁷

LATCH System (Lower Anchors and Tethers for Children)

PURE 7 OF 7

Zone Body construction with front and rear crumple zones

Tire Pressure Monitoring System with Easy-Fill Tire Alert^{28,29}

QX60

LUXE



Build & Price →



LUXE 1 OF 2

Includes All QX60 PURE Standard Features, Plus:

EXTERIOR

20" machined aluminum-alloy wheels with dark silver finish

255/50R20 all-season tires

Auto-dimming outside mirror (driver's side only)

Silver roof rails³

Capacitive touch sensors on rear handles

COMFORT & CONVENIENCE

Climate-controlled front seats

Heated second-row seats (outboard only)

Steering-wheel position memory

Entry/exit assist for driver's seat

Power tilting and telescoping steering column

Remote Engine Start⁷

HomeLink[®] Universal Transceiver

LUXE 2 OF 2**INFOTAINMENT**

Klipsch® 16-speaker Premium Audio System

DRIVER ASSISTANCE

ProPILOT Assist: Steering Assist and Intelligent Cruise Control with full-speed range, stop & hold and auto-resume²⁰

Blind Spot Intervention^{®20}

Front parking sensors²⁰

3D Around View[®] Monitor with fixed views and Moving Object Detection²⁰

Front Wide View²⁰

Invisible Hood View²⁰

Traffic Sign Recognition³⁰

Driver Attention Alert²⁰

QX60

SPORT



Build & Price →



SPORT 1 OF 2

Includes All QX60 LUXE Standard Features, Plus:
MECHANICAL & PERFORMANCE

INFINITI Intelligent All-Wheel Drive²⁰

EXTERIOR

20" aluminum-alloy wheels with gloss black finish

Gloss black roof rails³

Gloss black outside mirrors³

Unique grille mesh design and front lower fascia

Two-tone exterior roof on limited exterior colors

Body side moldings with gloss black accents

Dark exterior trim and emblems

"S" badge

COMFORT & CONVENIENCE

6-passenger seating capacity

Unique two-tone Dusk Blue TailorFit[®]-appointed seats

Second-row captain's chairs with inboard pivoting armrests

SPORT 2 OF 2

Removable center console – second row

Black headliner

AVAILABLE PACKAGES 1 2**1 GRAPHITE INTERIOR**

Graphite TailorFit[®]-appointed seats

2 BENCH SEAT PACKAGE

7-passenger seating capacity

60:40-split folding, sliding and reclining second-row bench seat²⁶

Deletes second-row captain's chairs and removable center console

QX60

AUTOGRAPH



Build & Price →



AUTOGRAPH 1 OF 3

Includes All QX60 LUXE Standard Features, Plus:

MECHANICAL & PERFORMANCE

INFINITI Intelligent All-Wheel Drive²⁰

Tow hitch member & receiver and 7-pin wiring harness

Trailer sway control

EXTERIOR

20-inch machined aluminum-alloy wheels with dark gray finish and tinted clear coat

INFINITI Light Path

Dark exterior trim and emblems

"Autograph" emblem on D-pillars

Two-tone exterior roof

Black roof rails³

COMFORT & CONVENIENCE

6-passenger seating capacity

Semi-aniline leather-appointed seats (first & second rows) with quilting, perforation and contrast stitching and piping

AUTOGRAPH 2 OF 3

Open Pore Ash Wood interior trim with Metal Inlay

Massaging front seats

Dual occupant memory system for passenger's seat

4-way front-passenger power lumbar

Second-row captain's chairs with inboard pivoting armrests

Removable center console – second row

Premium smooth leather-wrapped steering wheel

Rear-passenger manual sunshades

Third-row power-seatback return

Black headliner

Advanced Climate Control System with auto recirculation, Plasmacluster[®] air purifier and Grape Polyphenol filter⁶

10.8-inch Head-Up Display¹⁰

Smart RearView Mirror²⁰

Enhanced LED interior ambient lighting

Illuminated Kick Plates

AUTOGRAPH 3 OF 3

Motion-Activated Liftgate

USB-C charging port for third-row

120V power outlet²⁰

INFOTAINMENT

Klipsch® Reference Premiere Audio System with 20 speakers

Individual Audio

SAFETY

Driver seat-mounted front-center supplemental air bag²⁷

AVAILABLE PACKAGES 1**1 TECHNOLOGY PACKAGE – AUTOGRAPH**

ProPILOT Assist 2.1 featuring Lane Change Assist, Passing Assist and hands-off driving^{20,21}

INFINITI InTouch® Services with 3-year trial access to ProPILOT Assist 2.1^{8,21}

3D Around View® Monitor with spin capability²⁰

Fixed center console – second row

Accessories

Exterior



Interior



Cargo



Lighting & Tech



Towing



Pet



Back to Menu



Build & Price →

QX60

Exterior Accessories

EXTERIOR ACCESSORIES

Ready When
Life Happens



BACK TO SECTION

EXTERIOR ACCESSORIES

Take function and fashion to the next level with **Bright Silver Roof Rail Crossbars** or **Black Roof Rail Crossbars**, which make carrying your next adventure's necessities a breeze.³ Then add **Dark Chrome Outside Mirror Covers** to give your INFINITI even more distinction.



Black Roof Rail Crossbars³ and
Affiliated: Yakima® LoadWarrior – Cargo Basket^{3,31}



Dark Chrome Outside Mirror Covers

EXTERIOR ACCESSORIES

The **Rear Bumper Protector**, which comes in **Black** or **Clear**, has a precise fit to help protect your bumper from dings and scratches while enhancing your vehicle's appearance. Add **Splash Guards**, and you can reduce dirt spray on lower body panels while helping prevent nicks and scratches caused by road debris.



Black Rear Bumper Protector



Front Splash Guards

EXTERIOR ACCESSORIES

Helping to keep your wheels out of the wrong hands is simple with **Wheel Locks** or **Black Lug Nuts and Locks Kit**. Available in sets of four (one for each wheel), the wheel locks are constructed from hardened steel to increase durability and prevent corrosion.



Wheel Locks



Black Lug Nuts and Locks Kit

QX60

Interior Accessories

INTERIOR ACCESSORIES

A World of Detail



BACK TO SECTION

INTERIOR ACCESSORIES

Stay neat and organized amidst the chaos of life. An INFINITI **Trash Bin** helps keep your vehicle clean with a stylish design that complements your interior. Custom-made **All-Season Floor Mats – High Wall Liners** help protect your floors from what the day brings and secure in place using a grommet hole/positioning hook system. Enjoy peace of mind with the **Console Net**, which provides a versatile and lightweight solution for securing your everyday items.



All-Season Floor Mats – High Wall Liners

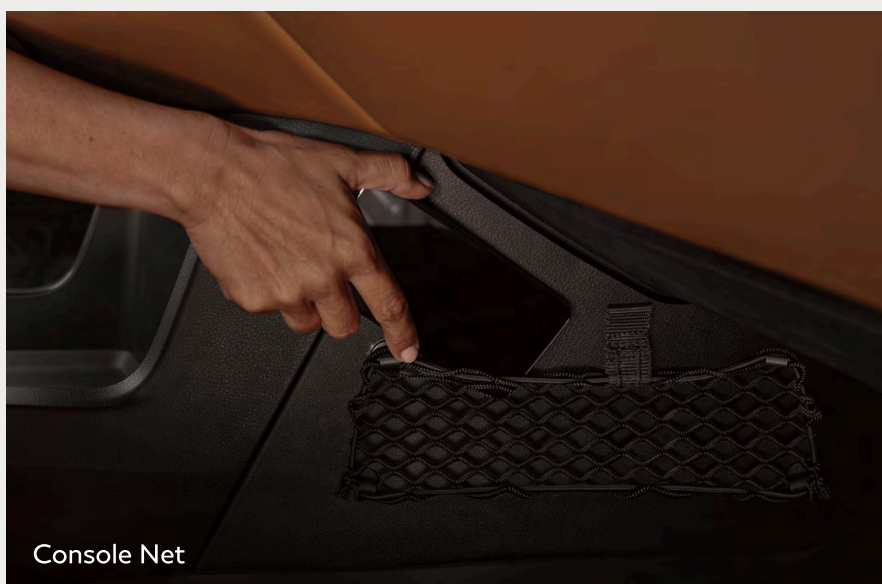

Console Net

INTERIOR ACCESSORIES

With the INFINITI **Tablet Holder**, second-row passengers can enjoy using their device hands-free – simply attach it to a compatible headrest. To keep the backseat tidy, attach a **Seatback Organizer**. The varying-sized pockets, including one waterproof pocket, hold your belongings in place and keep them off of the seats and floor.



Tablet Holder

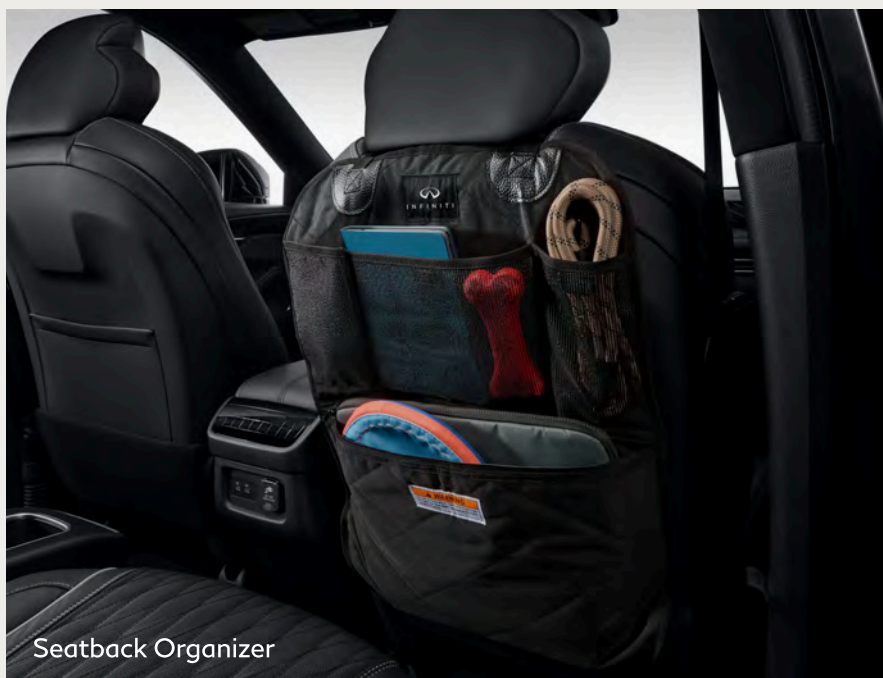

Seatback Organizer

INTERIOR ACCESSORIES

Give the third row some love with a **3rd Row Tray Liner** that protects the tray from scrapes and scratches when used for holding smartphones and more. Don't forget to protect the floors of your QX60 with custom-fitted **Carpeted Floor Mats**. They lock into place and are easy to remove for cleaning.



3rd Row Tray Liner



Carpeted Floor Mats

CARGO CONFIGURATIONS

Reconfiguration-Ready



BACK TO SECTION

CARGO CONFIGURATIONS

A **Reversible Cargo Area Protector** keeps your cargo area clean and helps protect it from scratches and damage. Fit more than you think with the **Cargo Organizer**, which features removable dividers that let you customize the space and secures in place with straps in your cargo area. Elevate your organization and functionality with the **Underfloor Storage Dividers (set of 2)**. They keep your items secure during your drive and make them easy to grab once you arrive at your destination.

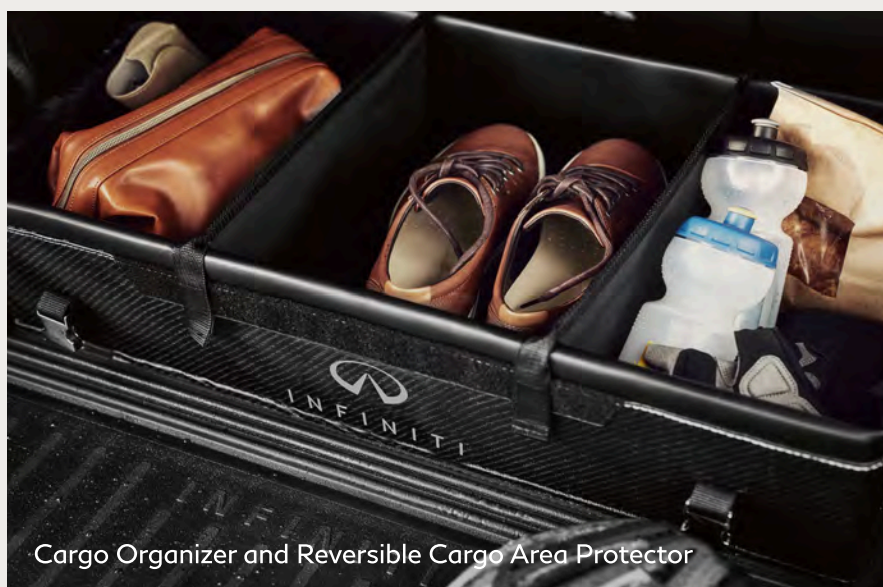

Cargo Organizer and Reversible Cargo Area Protector



Underfloor Storage Dividers (set of 2)

CARGO CONFIGURATIONS

Carrying fragile cargo can be tricky, but with **Cargo Blocks/Stabilizers**, you can secure your precious belongings in the cargo area without worry. The blocks are adjustable and connect to the **Reversible Cargo Area Protector** to keep items stable and in place. The **Cargo Net** is a great option for carrying small or uniquely shaped belongings, such as sports equipment, to protect them from moving freely in the cargo space.



Cargo Blocks/Stabilizers and Reversible Cargo Area Protector



Cargo Net

CARGO CONFIGURATIONS

Keep food and drinks cool for your next adventure with a **Soft Sided Cargo Cooler** – designed with a sleek, carbon fiber-patterned vinyl exterior and an insulated, leakproof interior. Keep your adventures going with a **Hatch Tent (10' x 10')**, and easily convert your cargo area into a sleeping space with a zippered, adjustable sleeve.



Soft Sided Cargo Cooler



Hatch Tent (10' x 10')

CARGO CONFIGURATIONS

Play it safe with INFINITI Medic, Adventure and Emergency Road Kits, which include all the essential tools to handle the unexpected. The **Medic Kit** is a first-aid bundle in a convenient and durable case with VELCRO® backing to stick to the carpet of your cargo space. The **Adventure Kit** features items such as a mini collapsible shovel, gloves and a tire pressure gauge, while the **Emergency Road Kit** may come in handy with its included flashlight, jumper cables and more.



Adventure Kit



Emergency Road Kit

QX60

Cargo Accessories

AFFILIATED: YAKIMA®

Adventure-Ready



BACK TO SECTION

AFFILIATED: YAKIMA®

These three accessories, the **Yakima® LoadWarrior – Cargo Basket**, **Yakima® FatCat EVO 6 – Ski Carrier** and the **Yakima® JayLow – Kayak Carrier**, are excellent companions to your adventurous side. No tools.... keep your skis, bags, snowboards, and kayaks secure on your journeys.^{3,31}



Affiliated: Yakima® FatCat EVO 6 – Ski Carrier^{3,31}



Affiliated: Yakima® JayLow – Kayak Carrier^{3,31}

AFFILIATED: YAKIMA®

Here's a bike rack that goes long on features and can fit up to two or four bikes. With zero-hassle ZipStrips™, quickly secure bikes with the **Yakima® RidgeBack 2 – Hitch Mount Bike Rack**.^{3,31} Need more room? The **RidgeBack 4** fits four bikes, tilts for easy access to your vehicle and features an anti-sway cradle that eliminates bike-to-bike contact on your drive. And when it comes to the **Yakima® OverNOut MD – Roof Mount Awning**, don't let its low profile fool you. This awning packs small but delivers big. From sideline cheers to ridgeline views, it offers excellent protection from the searing sun or sudden showers.^{3,31}



Affiliated: Yakima® RidgeBack 4 – Hitch Mount Bike Rack^{3,31}



Affiliated: Yakima® OverNOut MD – Roof Mount Awning^{3,31}

AFFILIATED: YAKIMA®

No matter what gear your friends show up to your driveway with, you'll be ready with the **Yakima® OffGrid – Cargo Basket**. More of a minimalist? The **Yakima® SupDawg – Surfboard Carrier** secures up to two surfboards up top.^{3,31}



QX60 Lighting & Tech Accessories



STYLING & LIGHTING

Statement, Made



BACK TO SECTION

QX60 Lighting & Tech Accessories

STYLING & LIGHTING

Let your aesthetic shine through. The **INFINITI Radiant® Exterior Welcome Lighting w/ Logo** illuminates the ground near the front doors with the INFINITI logo for an added sense of security. The **INFINITI Radiant® Dark Illuminated Kick Plates** (also in silver), feature a soft-glowing INFINITI logo along the bottom of the front and rear door sills.

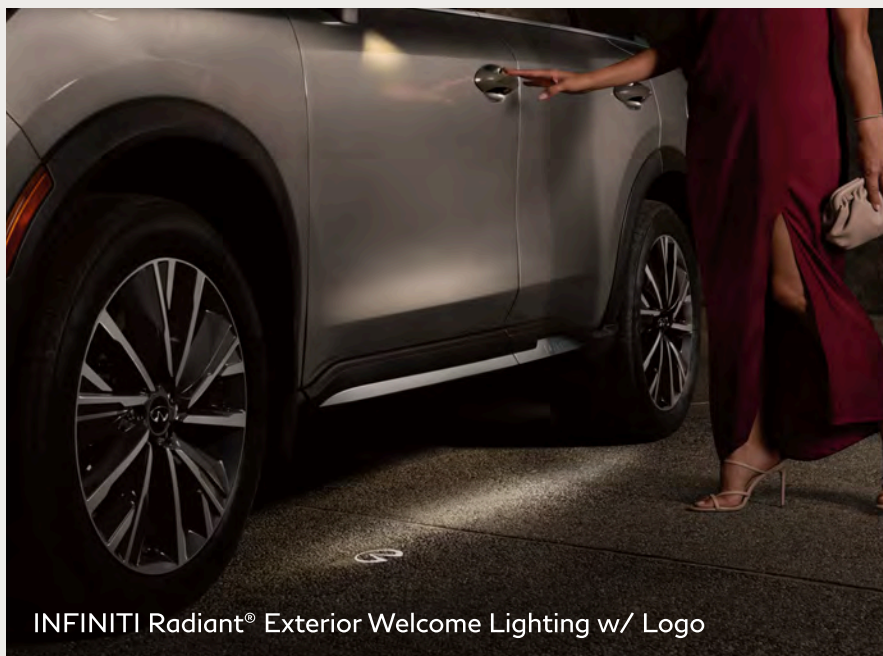

INFINITI Radiant® Exterior Welcome Lighting w/ Logo



INFINITI Radiant® Dark Illuminated Kick Plates

QX60 Lighting & Tech Accessories

STYLING & LIGHTING

Add to the commanding stance of your QX60 with the **Panoramic Illuminated Headliner**. Its premium look gives your drive a little more style and character. The **INFINITI Radiant® Illuminated Cargo Scuff Plates**, which come in a dark or silver finish, brighten, protect and add even more distinction to the cargo area.



Panoramic Illuminated Headliner



INFINITI Radiant® Dark Illuminated Cargo Scuff Plates

QX60 Lighting & Tech Accessories

STYLING & LIGHTING

Illuminate your INFINITI in even more ways with the bold and brilliant accent of **Pass Thru Lighting**, which adds a personal touch to the lower center console.



Pass Thru Lighting

TECH & PROTECTION

Connect to Greater Possibilities



[BACK TO SECTION](#)

QX60 Lighting & Tech Accessories

TECH & PROTECTION

Say goodbye to broken and frayed cables with the durable **USB Charging Cable Set** that's designed to keep devices powered up on the go.¹⁵ The **Dual Camera Drive Recorder** captures movement in front of the QX60 and inside of the cabin in the case of an accident or break-in, and it saves the footage so it can be shared for later use.³²



Dual Camera Drive Recorder³²

QX60 Lighting & Tech Accessories

TECH & PROTECTION

Gain an extra sense of assurance with the **Security Impact Sensor**, which sets off an alarm during an attempted window breaking and enhances the QX60's alarm system.



Security Impact Sensor

QX60 Lighting & Tech Accessories

TECH & PROTECTION

A feature that steps up the interior styling of PURE grade models is the sleek, modern **Frameless Auto-Dimming Rearview Mirror with HomeLink®**. It automatically keeps bright lights out of your eyes and opens the garage door with the press of a button. Before heading out, use **Remote Engine Start** to set your QX60 PURE to the perfect temperature.⁷



Frameless Auto-Dimming Rearview Mirror w/ HomeLink®



Remote Engine Start⁷

QX60

Towing Accessories

TOWING ACCESSORIES

Spontaneity Encouraged



BACK TO SECTION

TOWING ACCESSORIES

When it comes to road trips, connect and tow with ease by adding INFINITI Towing Accessories. Utilize your towing capabilities with the **Tow Hitch Receiver, Class II** which installs on the rear bumper in conjunction with the **Tow Hitch Finisher** for a sleek, factory-installed look. When properly equipped, pair the **Ball Mount – Class II** with either genuine accessory **Hitch Ball – Class II** or **Hitch Ball – Class III**.²⁴



Tow Hitch Finisher and Tow Hitch Receiver, Class II (Hitch Only)²⁴



PET ACCESSORIES

Fur Babies On Board



BACK TO SECTION

PET ACCESSORIES

Bring your fur family along for the ride. The foldable **Pet Carrier** features three mesh doors (top, side and front) with zipper closures, and the telescoping **Pet Ramp**, made with a strong yet lightweight aluminum construction, extends up to 64 inches. Once you're on the road, the **Pet Seat Protector** helps keep your second-row seats free from fur, and the **Pet Cargo Area Protector** does the same for the cargo space. Lastly, snag a **Dog Harness** – available in four sizes – to secure your dog via a tether to a rear-seat buckle and help limit their movement in the vehicle.



Pet Ramp, Pet Cargo Area Protector and Pet Carrier



Pet Seat Protector and Dog Harness



INFINITI PREMIUM CARE

Drive With Confidence

Keeping your INFINITI properly maintained keeps it thoroughly rewarding. That's why to help sustain confidence in your drive and to provide you with added peace of mind in a constantly changing world, each new 2027 INFINITI vehicle includes the INFINITI Premium Care maintenance program that provides up to 3 oil changes and 3 tire rotations for 36 months or vehicle's designated mileage period (whichever occurs first).

Factory-trained technicians use Genuine INFINITI parts to ensure the utmost care, quality and performance. For more information, please visit your local retailer.³³

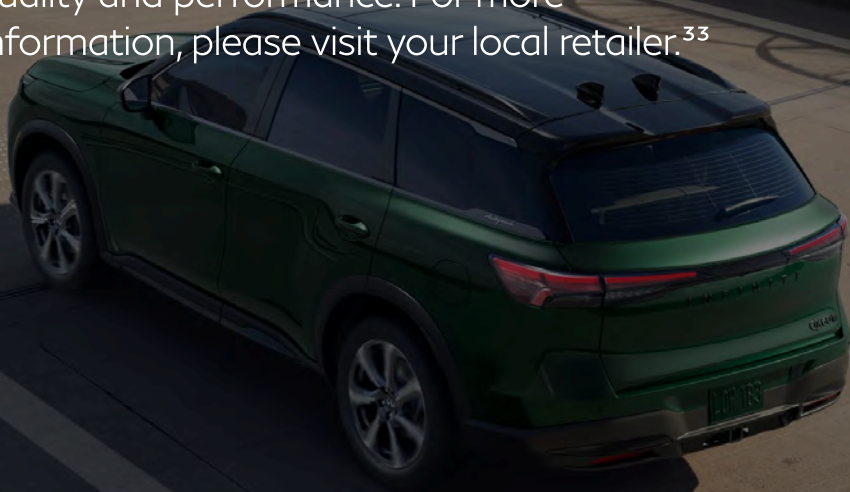



The Journey Begins

Build an INFINITI that's tailored to your taste and designed around your life.

Build Your QX60 →



JOIN OUR COMMUNITY



1 Feature availability varies by vehicle model year, model, trim level, packaging and options.

2 Extra cost option.

3 Cargo and load capacity limited by weight and distribution. Always secure cargo. Heavy loading of the vehicle with cargo, especially on the roof, will affect the handling and stability of the vehicle.

4 Do not perform slide forward function with the Child Restraint System occupied.

5 When operating the rear power-seatback return, make sure that the vehicle is stopped and the transmission is in the P (Park) position.

6 The Advanced Climate Control System with Plasmacluster® air purifier helps scrub the air in the vehicle's interior. The system senses exterior odors, suppresses unpleasant interior odors, stops the inflow of external odors and helps keep the cabin smelling fresh, but does not always eliminate odors.

7 Remote Engine Start to be used only in accordance with laws or rules in effect in your vehicle's location.

8 See www.infiniti.com/intouch/legal for more INFINITI InTouch features/services information.

9 Information displayed in image is dependent on how vehicle is equipped. Driving is serious business and requires your full attention. If you have to use the feature while driving, exercise extreme caution at all times so full attention may be given to vehicle operation.

10 Information displayed in image is dependent on how vehicle is equipped. Do not use for extended periods of time. See Owner's Manual for important safety information.

11 Available feature. Individual Audio is intended to isolate select audio sources for equipped seating positions, and cannot buffer interior sound. Before using, read Owner's Manual for further information.

12 Use Hands Free Text Messaging when parked in a safe location. If you must use while driving, monitor traffic conditions and keep both hands on the steering wheel to prevent collisions. Compatible device required. Message and data rates may apply.

13 Never program while driving. GPS mapping may not be detailed in all areas or reflect current road status.

14 Feature availability varies by vehicle model year, model, trim level, packaging and options. Consumer activation of a compatible INFINITI InTouch® Services package ("Package") required. Package trial period included with eligible new vehicle purchase or lease. Trial period may be subject to change or termination at any time and without notice. After trial period ends, monthly subscription fee required. Driving is serious business and requires your full attention. Only use features when safe and legal to do so. Never program while driving. GPS mapping may not be detailed in all areas or reflect current road status. Connectivity service required. App subscriptions may be required. Data rates may apply. Subject to third party service availability. Should such service providers terminate or restrict service or features, service or features may be suspended or terminated without notice or with no liability to INFINITI or its partners or agents. Google, Google Play and Google Maps are trademarks of Google LLC. For more information, see www.INFINITUSA.com/intouch/legal.

15 Driving is serious business and requires your full attention. If you have to use the connected device while driving, exercise extreme caution at all times so full attention may be given to vehicle operation. External device not included.

16 Availability may vary. INFINITI InTouch Services subscription may be required. Always read and follow instructions for safe update procedures. You may contact INFINITI at 1-833-283-1886 for assistance with software updates. You may also visit your local INFINITI retailer; retailer charges may apply.

17 MyINFINITI App shown for illustrative purposes only. Feature functionality may vary by vehicle model and options. See MyINFINITI Terms and Conditions.

18 INFINITI vehicle with "SiriusXM with 360L" capability: SiriusXM with 360L trial period is included with the purchase or lease of a new INFINITI vehicle if: (i) vehicle is equipped with SiriusXM with 360L capability and (ii) vehicle is purchased or leased from new INFINITI dealer stock. Trial period begins on the purchase or lease date of the qualifying new INFINITI vehicle. SiriusXM with 360L is owned and operated by SiriusXM, use of SiriusXM account and its services and features are subject to the SiriusXM Customer Agreement and Privacy Policy available at siriusxm.com, and are not within INFINITI's control. Should SiriusXM terminate, change, or restrict service or features, service or features may be suspended or terminated without notice or with no liability to INFINITI or its partners or agents. INFINITI and its partners or agents are also not responsible for associated costs or other third party changes that may be required for continued operation due to cellular network unavailability, restriction, or termination (including equipment replacements/upgrades, if available, or roaming charges on alternative networks). Trial period is subject to change or early termination at any time without notice. SiriusXM and related logos are trademarks of Sirius XM Radio Inc. and its respective subsidiaries.

SiriusXM and SiriusXM with 360L Trial Subscription: Service will automatically stop at the end of your trial subscription period unless you decide to continue service. Trial is non-transferable. If you do not wish to enjoy your trial, you can cancel by calling the number below. All SiriusXM services require a subscription, each sold separately by SiriusXM after the trial period. **Service subject to the SiriusXM Customer Agreement and Privacy Policy, visit siriusxm.com for complete terms and how to cancel which includes online methods or calling 1-866-635-2349.** Some services and features are subject to device capabilities and location availability. Satellite service not available in AK & HI. Certain features and/or content may not be available in vehicles with SiriusXM with 360L unless an active data connection is enabled in the vehicle. Content varies by SiriusXM subscription package. All fees, content and features are subject to change.

19 120-volt power outlet is intended only for use with compatible items. Please check specifications of wattage and amperage of items to be plugged in to determine compatibility.

20 Driver-assist and safety features have limitations which affect how they function in certain situations. The driver must never rely exclusively on any vehicle feature to warn about, prevent or lessen the severity of a collision. It is the driver's responsibility to always be in control, monitor the surroundings and safely operate the vehicle. Read your vehicle's Owner's Manual for further information.

21 INFINITI InTouch Services customer-activated subscription required. See www.infiniti.com/intouch/legal for more information. ProPILOT Assist 2.1 cannot prevent collisions. It is the driver's responsibility to be in control of the vehicle and monitor traffic conditions at all times. Hands-off freeway driving is possible when driving in a single lane, on the condition that the driver remains attentive on the road ahead and is prepared to immediately take manual control of the steering wheel when conditions of the road, traffic, and vehicle require it. System operates only when lane markings are detected. Does not function in all weather, traffic and road conditions. System has limited control capability and the driver may need to steer, brake or accelerate at any time to maintain safety. See Owner's Manual for safety information.

22 Virtual composite 360° view.

23 2027 EPA Fuel Economy Estimates 22 City/28 Highway/24 Combined for PURE and LUXE FWD; 21 City/27 Highway/24 Combined for PURE, LUXE, SPORT and AUTOGRAPH AWD. Actual mileage may vary with driving conditions. Use for comparison only.

24 Towing capacity varies by configuration. See INFINITI Towing Guide and Owner's Manual for additional information. Always secure cargo.

25 Rear Door Alert System does not detect people or cargo. Always check rear seat before exiting. See Owner's Manual for safety information.

26 Do not ride in a moving vehicle when the seatback is reclined. For the most effective protection, the seat should be upright. See Owner's Manual for safety information.

27 Air bags are only a supplemental restraint system. Always wear your seat belt. Rear-facing child restraints should not be placed in the front-passenger's seat. All children 12 and under should ride in the rear seat properly secured in child restraints, booster seats or seat belts according to their size. Air bags will only inflate in certain accidents. See Owner's Manual for safety information.

28 Tire Pressure Monitoring System is not a substitute for regular tire pressure checks. See Owner's Manual for safety information.

29 Vehicle must be on for the Easy-Fill Tire Alert to operate.

30 Traffic Sign Recognition may not detect and read all traffic signs in all conditions. Driver should monitor all traffic signs and obey all traffic laws. See Owner's Manual for details.

31 Accessories shown on vehicle are not genuine INFINITI parts/accessories. Not warranted by INFINITI. Refer to product manufacturer for warranty details. INFINITI limited warranty does not cover damages or failures to the vehicle caused by improper installation or alterations of any accessory or component. Contact your retailer for details.

32 Dual Camera Drive Recorder to be used only in accordance with any laws or rules in effect in your vehicle's location that may apply to audio or video recordings of drivers and passengers.

33 INFINITI Premium Care oil/tire maintenance provided through Elite Protection Program is included with the purchase/lease of a new 2026 or 2027 INFINITI vehicle from retailer stock. Other restrictions apply. **In Florida (License #60128), Missouri, North Dakota, Oregon, and Vermont, INFINITI Extended Services North America is backed by Nissan Extended Services North America, Inc., P.O. Box 685004, Franklin, TN 37068-5004.** Replacement of any part will be made with a new Genuine INFINITI or INFINITI-approved replacement part in use at the time of repair. The replacement part may differ from the original.

Apple CarPlay® and CarPlay® are registered trademarks of Apple Inc. iPhone® is a registered trademark of Apple Inc. All rights reserved. iPhone® or other external device not included. Pairing speed may vary when establishing CarPlay connection wirelessly. Wireless smartphone integration only supported with CarPlay. Bluetooth® word mark and logos are owned by Bluetooth SIG, Inc., and any use of such marks by INFINITI is under license. FUBO is a trademark of FUBOTV MEDIA INC. Google, Android, Android Auto, YouTube Music and other marks are trademarks of Google LLC. Compatible Android phone and compatible active data plan required. To wirelessly use Android Auto on your car display, you need a compatible Android smartphone with an active data plan. You can check which smartphones are compatible at g.co/androidauto/requirements. HBO MAX is a trademark of Home Box Office, Inc. HD Radio® is a registered trademark of iBiquity Digital Corporation. HomeLink® is a registered trademark of Gentex Corporation. Klipsch® is a registered trademark of Klipsch Group, Inc. myQ® is a registered trademark of The Chamberlain Group, Inc. Pandora® is a registered trademark of Pandora Media, LLC. Plasmacluster® is a registered trademark of the Sharp Corporation. PLUTO is a trademark of Pluto Inc. PRIME VIDEO is a trademark of Amazon Technologies, Inc. Qi® and Qi2® are registered trademarks of Wireless Power Consortium Inc. SiriusXM is a registered trademark of Sirius XM Radio Inc. Velcro® is a registered trademark of Velcro LP Holdings LLC.

This brochure is intended for general descriptive and informational purposes only. It is subject to change and does not constitute an offer, representation or warranty (express or implied) by Nissan North America, Inc. Interested parties should confirm the accuracy of any information in this brochure as it relates to a vehicle directly with Nissan North America, Inc. before relying on it to make a purchase decision. Nissan North America, Inc. reserves the right to make changes, at any time, without prior notice, in prices, colors, materials, equipment, specifications, and models and to discontinue models or equipment. Due to continuous product development and other pre- and post-production factors, actual vehicle, materials and specifications may vary from this brochure. Some vehicles shown with optional equipment. See the actual vehicle for complete accuracy. Availability and delivery times for particular models or equipment may vary. Specifications, options and accessories may differ in Hawaii, U.S. territories and other countries. For additional information on availability, options or accessories, contact your INFINITI retailer or Nissan North America, Inc.

BACK TO MENU